

## Connectors according to DIN 41612 / IEC 60603-2

### Type E

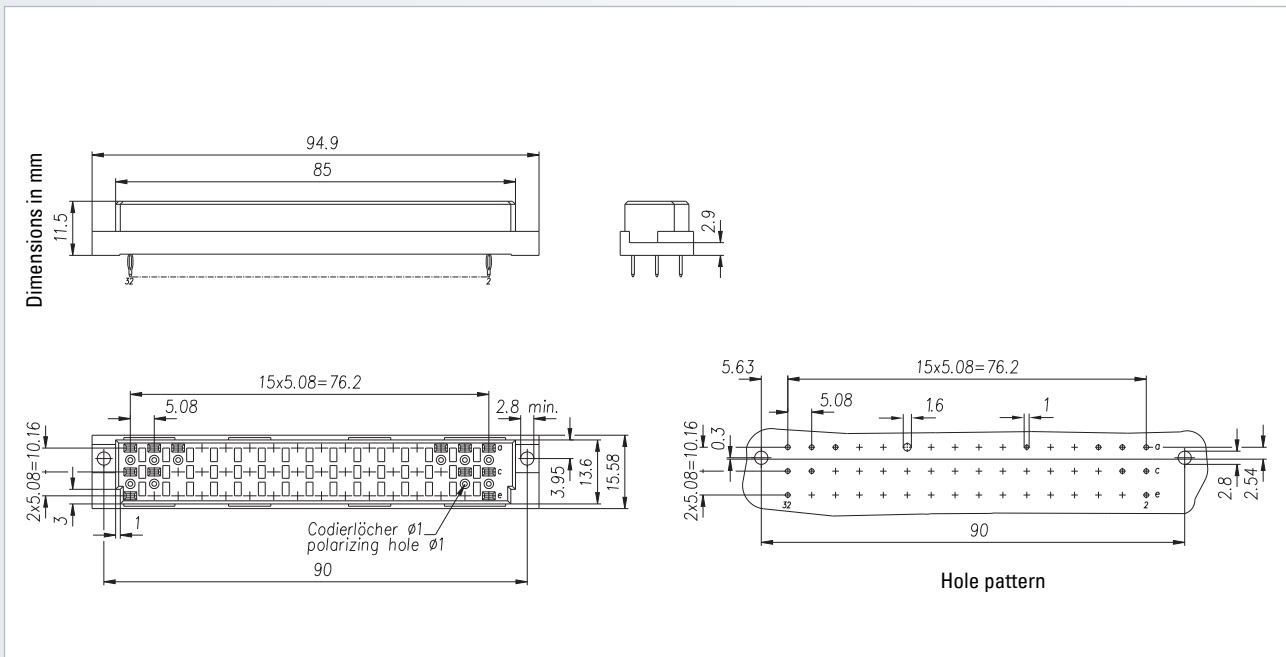

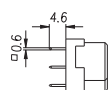
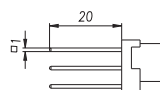
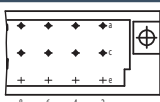
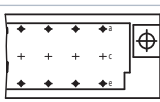
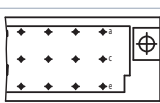

Female connector

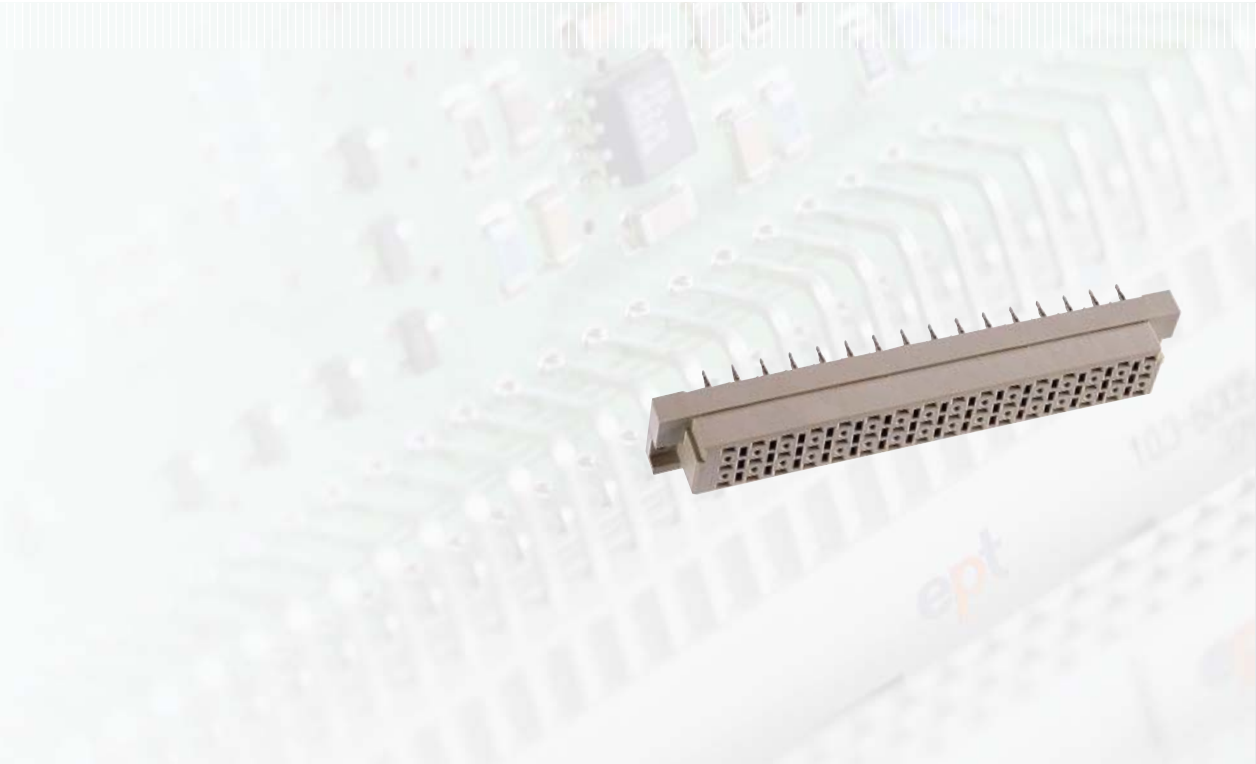

No. of contacts	Contact arrangement	Press-fit technology – Performance level II	
		Termination length	
			
Part number			
32		108-60054	108-60015
32		108-60044	108-60025
48		108-60084	108-60065

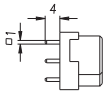
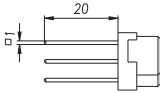
<b>Accessories</b> <ul style="list-style-type: none"> <li>– Press-fit tool (see page 208)</li> <li>– Support tool (see page 209)</li> <li>– Coding accessories (see page 160)</li> </ul>	<b>On request</b> <ul style="list-style-type: none"> <li>– Performance levels I + III or customer-specific</li> <li>– Special contact length</li> </ul>	<b>Options</b> <ul style="list-style-type: none"> <li>– Without flange</li> <li>– Contact arrangement (see page 162)</li> </ul>
--	---	---

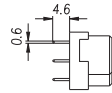

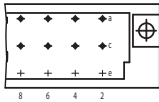
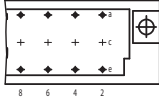
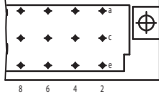
No. of contacts	Contact arrangement	Solder technology – Performance level II				
		Termination length				
						
Part number						
32		108-40014	108-40015	–	108-40044	108-40046
32		108-40024	108-40025	–	108-40034	108-40036
48		108-40064	108-40065	108-40084	108-40074	108-40076

<b>Accessories</b> – Coding accessories (see page 160)	<b>On request</b> – Performance levels I + III or customer-specific – Special contact length – Also in THTR	<b>Options</b> – Board lock (see page 159) – Contact arrangement (see page 162)
---	--	---

## X-ON Electronics

Largest Supplier of Electrical and Electronic Components

*Click to view similar products for [FFC & FPC Connectors](#) category:*

*Click to view products by [EPT manufacturer](#):*

Other Similar products are found below :

[HFW11R-1STE1H1LF](#) [FH29B-100S-0.2SHW\(99\)](#) [FA5S008HP1](#) [FH29B-120S-0.2SHW\(99\)](#) [FH29B-80S-0.2SHW\(99\)](#) [FHS-16](#) [FPH-2022G](#)  
[52610-1075](#) [52610-1275](#) [52610-1934](#) [XF3M\(1\)-1415-1B-R100](#) [501864-3091-TR225](#) [0525594033](#) [086210010340800](#) [086222026001800](#)  
[52271-2869-CUT-TAPE](#) [62674-201121DLF](#) [62684-36210E9ALF](#) [52610-1675](#) [52746-1671-TR250](#) [10051922-2810EHLF](#) [6-520415-9](#)  
[BD021-09A-A1-0350-0200-0550-LD](#) [SFV6R-1STE9HLF](#) [XF3M-2915-1B-R100](#) [1658549-1](#) [62674-221121ALF](#) [46214008010800](#)  
[046298003000883](#) [151660622](#) [842-816-2630-035](#) [AYF530665TA](#) [AYF351525](#) [046296011930846+](#) [AYF352325A](#) [046254020000800+](#)  
[FH19C-13S-0.5SH\(99\)](#) [FH39J-51S-0.3SHW\(99\)](#) [AYF355125A](#) [AYF530365TA](#) [FH29B-44S-0.2SHW\(99\)](#) [SFW5R-2STAE9LF](#) [AYF351125A](#)  
[AYF350725A](#) [62684-502100AHLF](#) [FH39-61S-0.3SHW\(99\)](#) [AYF414035A](#) [10064555-172520HLF](#) [AYF212335A](#) [504754-2500](#)