

Modicon® M340™ automation platform

Catalog
2010



Schneider
Electric



A full range of catalogs for



Detection



Global Detection Electronic and electromechanical sensors

MKTED208052EN

Photo-electric sensors
Proximity sensors
Capacitive proximity sensors
Ultrasonic sensors
Limit switches
Pressure switches
Rotary encoders
Radio frequency identification
Machine cabling accessories

Automation



Modicon® Quantum™ automation platform Catalog 2009

MKTED208011EN-US

Safety PLCs
Safety CPUs
Unity™ Concept™ and
ProWORX™ software



Modicon® Premium™ automation platform Catalog 2010

MKTED208054EN-US

Unity processors
PL7 processors
Communication software



Modicon® M340™ automation platform Catalog 2010

DIA6ED2081007EN-US

PLCs
Discrete, analog I/O and
application-specific solutions
Communication

Automation



Modicon® Momentum™ distributed I/O and control

MKTED205061EN



Twido® programmable controller and TwidoSuite™ software

DIA3ED2090202EN

Controller base
Discrete, analog I/O
Communication



Automation functions, relays, interfaces and power supplies

MKTED207031EN

Smart relays
Timing relays
Measurement & control relays
Analog interfaces
Counters
Plug-in relays
Interfaces for discrete signals
Power supplies & transformers

Software

PLCs and safety controllers
programming software

Operator dialog



Control and signalling components

MKTED208031EN

Control and signalling units
Control stations & enclosures
Cam switches
Beacons and indicator banks
Pendant control stations
Controllers
Emergency stops
Foot switches



Magelis® Human/Machine Interfaces Catalog 2010

MKTED206071EN-US

Operator interface terminals
Industrial PCs
HMI and SCADA PC-based
software

Software

Vijeo Designer
Operator terminal software

Motion and Drives



Lexium® 32 Servo Drives motion control Catalog 2009/2010

DIA7ED2090405EN-US

Motion controllers
Servo drives and Servo motors
Stepper motors and drives
Integrated drives
Modicon Premium
motion control modules



Soft starters and variable speed drives

MKTED206111EN

Soft starters and variable speed
drives

Software

Software for drives
Motor control programming
software

.....Automation & Control functions



Motor control



Motor starter solutions Control and protection components

MKTED205103EN

Contactors
Circuit-breakers, fuse carriers
Thermal relays
Combinations, motor controllers
Mounting solutions
Motor starter mounting kits

Machine safety

*This catalog contains
Automation and Control function
products relating to machines
Safety*



Preventa™ Machine Safety Products Catalog 2009

MKTED208051EN-US

Safety PLCs
Safety controllers
Safety monitors
Safety solutions on AS-Interface
cabling system
Safety switches
Safety light curtains
Safety mats
Emergency stops
Control stations
Enabling switches
Foot switches
Beacons & indicator banks
Switch disconnectors
Thermal-magnetic motor circuit
breakers
Enclosed D.O.L. starters

Software

XPSMFWIN configuration
software
XPSMCWIN configuration
software

Interfaces and I/O



Terminal blocks

MKTED207011EN

Terminal blocks
Cable ends



Advantys™ STB IP 20 distributed inputs/outputs Catalog 2010

MKTED208053EN-US

Modules for automation station
Network interfaces
Power distribution
Digital I/O, analogs and
application-specific

Software

STB configuration software

Power supplies



Phaseo® power supplies and transformers

DIA3ED2061209EN

Switch mode power supplies
Filtered rectified power supplies
Transformers

Systems & architectures

*This catalog contains
Automation and Control function
products relating to
Communication*



Machine & Installations with industrial communication

MKTED207012EN

Preferred implementations
Ethernet TCP/IP, the universal
communication standard
CANopen for machines and
installations
AS-interface, simple and safe

Products

Human-Machine interface
Controllers and PLCs
Field devices
Infrastructure and wiring
Gateways

Software and tools

Collaborative Automation
Partner Program & Partners

1 - Modicon® M340™ processors, racks, power supply modules and packs

Processors selection guide	1/2
■ Processor modules	1/4
■ Power supply modules	1/10
■ Single-rack configuration	1/14
■ Multi-rack configuration	1/16
■ Modicon M340 pre-assembled packs	1/18

2 - Input/output and application-specific modules

■ Discrete I/O modules	2/2
■ Analog I/O modules and programmable process control	2/22
■ IP 67 and IP20 distributed I/O modules	2/36
■ Counter modules	2/38
■ Motion control module	2/46
■ MFB motion control	2/52

3 - Communication

Selection guide	3/2
■ Ethernet Modbus®/TCP network	3/4
■ CANopen machines and installation bus	3/38
■ Modbus and character mode serial link	3/44

4 - Software

Unity™ selection guide	4/2
■ Unity software	4/6
■ Vijeo® Citect® supervisory software	4/50
■ OPC® data server software	4/60

5 - Connection interfaces, power supplies and Human/Machine Interfaces

■ Modicon® Telefast® ABE 7 pre-wired system	5/2
■ Phaseo® Universal range power supplies	5/16
HMI selection guides	5/28

6 - Services

■ Technical information	6/2
□ CANopen data sheet	6/8
□ Compatibility between discrete input modules and sensors	6/10
□ Power consumption table	6/13
■ Product reference index	6/14

Advantys™, Altistart®, Altivar®, Concept™, ConneXium™, FactoryCast™, Fipio®, Fipway®, Lexium®, Magelis®, M340™, Modbus®, Modbus Plus™, Modicon®, Momentum™, OSitrack™, Phaseo®, PowerSuite™, Premium™, Preventa™, ProWORX 32™, Quantum™, Schneider Electric, Telefast®, TeSys®, Transparent Ready®, TSX Micro™, Twido®, TwidoSoft™, TwidoSuite™, Unity™, Unity™ Pro, Vijeo Designer™, Vijeo Look™ X-Way® are trademarks or registered trademarks of Schneider Electric. Other trademarks used herein are the property of their respective owners.

1.1 - Modicon® M340™ processors, racks, power supply modules and packs

- Processors selection guide 1/2
- Processor modules
 - Introduction, description 1/4
 - Memory structure 1/6
 - Specifications 1/8
 - References 1/9
- Power supply modules
 - Introduction, description 1/10
 - Functions 1/11
 - Specifications 1/12
 - References 1/13
- Single-rack configuration
 - Introduction, description 1/14
 - Function 1/14
 - References 1/15
 - Dimensions, mounting 1/15
- Multi-rack configuration
 - Introduction, description 1/16
 - References 1/17
- Modicon M340 pre-assembled packs
 - Introduction, description 1/18
 - References 1/19

Modicon® M340™ automation platform

Modicon M340 processors

1

Modicon® M340™ platform for Unity Pro™ software offer

BMX 34 10 Standard processor

BMX 34 20 Performance processors



Racks	Number of racks	2 (4, 6, 8 or 12 slots)	4 (4, 6, 8 or 12 slots)
	Max. number of slots (excluding power supply module)	24	48
Inputs/Outputs	In-rack discrete I/O (1)	512 channels (modules with 8, 16, 32 or 64 channels)	1024 channels (modules with 8, 16, 32 or 64 channels)
	In-rack analog I/O (1)	128 channels (modules with 2, 4, 6 or 8 channels)	256 channels (modules with 2, 4, 6 or 8 channels)
	Distributed I/O	Limited depending on the type of medium: Over Ethernet Modbus/TCP network via network module (63 devices with I/O Scanning function), over Modbus link (32 devices)	
In-rack application-specific channels	Max. number of channels (counter, motion control and serial link)	20	36
	Counter (1)	BMX EHC 0200, 60 kHz 2 channels or BMX EHC 0800, 10 kHz 8 channels modules	
	Motion control (1)	BMX MSP 0200, 200 kHz 2 channels with PTO outputs "Pulse Train Output" module for servo drives	
	Process control, programmable loops	Process control EFB library	
Integrated communication ports	Ethernet Modbus®/TCP network	-	
	CANopen Master machine and installation bus	-	
	Serial link	1 in RTU/ASCII Modbus master/slave mode or in character mode (non-isolated RS232/RS485, 0.3...38.2 Kbit/s)	
	USB port	1 programming port (PC terminal)	
Communication modules	Max. number of networks (1)	1 (BMX NOE 0110/0110 network module)	2 (BMX NOE 0100/0110 network module)
	Ethernet Modbus/TCP network	1 x 10BASE-T/100BASE-TX (Modbus/TCP, BOOTP/DHCP, FDR client/server, Global Data, I/O Scanning, web server (standard, class B30 or configurable, class C30) (2)	
Internal memory capacity	Internal user RAM	2,048 Kb	4,096 Kb
	Program, constants and symbols	1,792 Kb	3,584 Kb
	Located/unlocated data	128 Kb	256 Kb
Memory card capacity (on processor)	Backup of program, constants and symbols	8 Mb as standard	
	Hosting and display of user web pages	- (2)	
	File storage	-	8 or 128 Mo (depending optional card BMX RMS ●●8MPF)
Application structure	Master task	1	
	Fast task	1	
	Event tasks	32	64
No. of K instructions executed per ms	100% Boolean	5.4 K instructions/ms	8.1 K instructions/ms
	65% Boolean + 35% fixed arithmetic	4.2 K instructions/ms	6.4 K instructions/ms
Rack power supply		24 V ~ isolated, 24...48 V ~ isolated or 100...240 V ~ power supply module	

Modicon M340 processor

BMX P34 1000 (3)

BMX P34 2000

Page	1/9
-------------	-----

(1) The maximum values for the number of discrete I/O, analog I/O and counter channels and the number of networks are not cumulative (they are limited by the max. number of slots in the configuration, 2 racks: 23, 3 racks: 35 and 4 racks: 47.
 (2) User web pages with FactoryCast™ module **BMX NOE 0110** (12 Mb) available.
 (3) 5 Modicon M340 Packs references (pre-assembled configuration) with **BMP P34 1000 66**-processor are also available. See page 1/19.

BMX 34 20 Performance processors (continued)



1 (4, 6, 8 or 12 slots)		
48		
1,024 channels (modules with 8, 16, 32 or 64 channels)		
256/66 channels (modules with 2, 4, 6 or 8 channels)		
Limited depending on the type of medium: CANopen bus (63 devices), Ethernet Modbus®/TCP network via network module (63 devices with I/O Scanning function), Modbus link (32 devices)		
36		
BMX EHC 0200, 60 kHz 2 channels or BMX EHC 0800, 10 kHz 8 channels modules		
BMX MSP 0200, 200 kHz 2 channels with PTO outputs "Pulse Train Output" module for servo drives		
MFB (Motion Function Blocks) library (control of drives or servo drives on the CANopen bus)	–	MFB (Motion Function Blocks) library (control of drives or servo drives on the CANopen bus)
Process control EFB library		
–	1 x 10BASE-T/100BASE-TX (Modbus/TCP, BOOTP/DHCP, FDR client, E-mail notification, class B10 standard web server)	
1 (63 slaves, 50...1,000 Kbit/s, class M20)	–	1 (63 slaves, 50...1,000 Kbit/s, class M20)
1 in RTU/ASCII Modbus master/slave mode or in character mode (non-isolated RS232/RS485, 0.3...38.2 Kbit/s)	–	
1 programming port (PC terminal)		
2 (BMX NOE 0100/0110 network module)		
1 x 10BASE-T/100BASE-TX (Modbus/TCP, BOOTP/DHCP, FDR client/server, Global Data, I/O Scanning, web server (standard, class B30 or configurable, class C30) (2)		
4,096 Kb		
3,584 Kb		
256 Kb		
8 Mb as standard		
– (2)		
8 or 128 Mb (depending optional card BMX RMS ●●8MPF)		
1		
1		
64		
8.1 K instructions/ms		
6.4 K instructions/ms		
24 V \equiv isolated, 24...48 V \equiv isolated or 100...240 V \sim power supply module		

BMX P34 2010

BMX P34 2020

BMX P34 2030

Modicon® M340™ automation platform

Processor modules

1

Modicon M340 automation platform

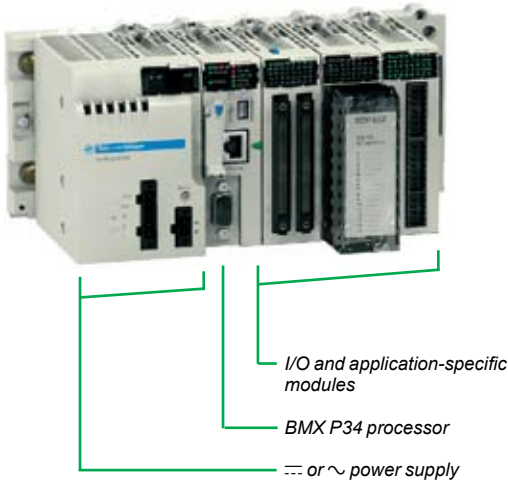

Introduction

Standard and Performance processors from the Modicon® M340™ automation platform manage an entire PLC single-rack or multi-rack station on which slots can be equipped with:

- Discrete I/O modules
- Analog I/O modules
- Application-specific modules (counter, motion control, Ethernet Modbus®/TCP communication)

The five processors offered have different memory capacities, processing speeds, number of I/O, and type of communication ports.

In addition, depending on the model, they offer a maximum (non-cumulative) of:

- 512 to 1024 discrete I/O
- 128 to 256 analog I/O
- 20 to 36 application-specific channels (counter, motion control and serial link)
- 0 to 3 Ethernet Modbus/TCP networks (with or without integrated port and 2 network modules maximum)

Depending on the model, Modicon M340 processors include:

- A 10BASE-T/100BASE-TX Ethernet Modbus/TCP port
- A CANopen machine and installation bus
- A Modbus serial link
- A USB type TER port (for a programming terminal or a Human/Machine interface Magelis® XBT GT/GK/GTW)

Each processor is supplied with a memory card used for:

- Backing up the application (program, symbols and constants)
- Activating a standard web server for the Transparent Ready® B10 class integrated Ethernet port (depending on the model)

This memory card can be replaced with an optional memory card (ordered separately), that supports:

- Backing up the application and activating the standard web server
- An 8 or 128 Mb storage area for additional data organized in a file system (directories and sub-directories)

Programming Modicon® M340™ applications

To set up processors from the Modicon M340 automation platform, you will need either:

- Unity™ Pro Small programming software
- Unity Pro Medium, Large, Extra Large or XLS programming software identical to that used to set up Modicon® Premium™ and Modicon® Quantum™ automation platforms
- Unity EFB toolkit software for developing EF and EFB libraries in C language
- Unity™ SFC View software for viewing and diagnostics of applications written in Sequential Function Chart language (SFC) or Grafcet™

The function block software libraries provide Modicon M340 processors with the processing capability required to meet the needs of special applications in the following areas:

- Process control via programmable control loops (EF and EFB libraries)
- Motion control with multiple independent axis functions (MFB) library. The axes are controlled by Altivar® 31/71 variable speed drives or Lexium® 05/15 servo drives connected over the CANopen machine and installation bus.

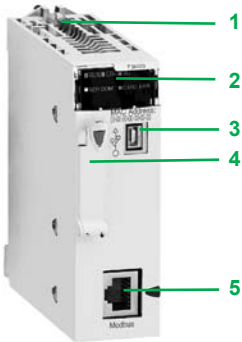

BMX P34 1000

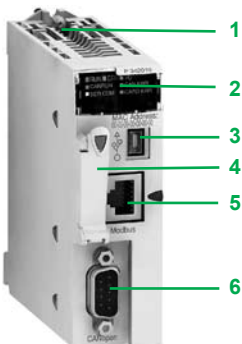

BMX P34 2010

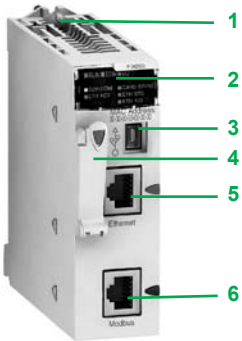

BMX P34 2020

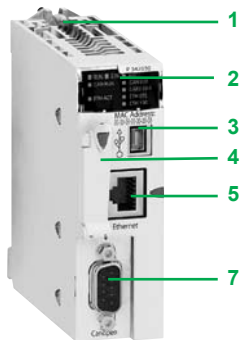

BMX P34 2030

Description of BMX P34 1000/2000/2010 processors

BMX P34 1000/2000/2010 Standard and Performance single-format processors have the following on the front panel:

- 1 Safety screw for locking the module in its slot (marked 0) in the rack
- 2 A display block comprised of 5 or 7 LEDs, depending on the model:
 - RUN LED (green): Processor running (program executing)
 - ERR LED (red): Processor or system detected fault
 - I/O LED (red): I/O module detected fault
 - SER COM LED (yellow): Activity on the Modbus® serial link
 - CARD ERR LED (red): Memory card missing or inoperative
 - CAN RUN LED (green): Integrated CANopen bus operational (**BMX P34 2010** only)
 - CAN ERR LED (red): Integrated CANopen bus detected fault (**BMX P34 2010** only)
- 3 A mini B USB connector for a programming terminal (or Magelis® XBT GT/GK/GTW operator interface (1))
- 4 A slot equipped with Flash memory card for backing up the application (an LED, located above this slot, indicates recognition of or access to the memory card)
- 5 An RJ45 connector for the Modbus serial link or character mode link (RS 232C/RS 485, 2-wire, non-isolated)
- 6 A 9-way SUB-D connector for the integrated CANopen master bus (**BMX P34 2010** only)

Description of BMX P34 2020/2030 processors with integrated Ethernet Modbus®/TCP port

BMX P34 2020/2030 Performance single-format processors have the following on the front panel:

- 1 Safety screw for locking the module in its slot (marked 0) in the rack
- 2 A display block comprised of 8 or 10 LEDs, depending on the model:
 - RUN LED (green): Processor running (program executing)
 - ERR LED (red): Processor or system detected fault
 - I/O LED (red): I/O module detected fault
 - SER COM LED (yellow): Activity on the Modbus serial link
 - CARD ERR LED (red): Memory card missing or inoperative
 - ETH ACT LED (green): Activity on the Ethernet Modbus/TCP network
 - ETH STS LED (green): Ethernet Modbus/TCP network status
 - ETH 100 LED (red): Data rate on the Ethernet Modbus/TCP network (10 or 100 Mbit/s)
 - CAN RUN LED (green): Integrated CANopen bus operational (**BMX P34 2010** only)
 - CAN ERR LED (red): Integrated CANopen bus detected fault (**BMX P34 2010** only)
- 3 A mini B USB connector for a programming terminal or Magelis XBT GT/GK/GTW operator interface (1)
- 4 A slot equipped with Flash memory card for backing up the application (an LED located above this slot indicates recognition of or access to the memory card)
- 5 An RJ45 connector for connection to the Ethernet Modbus/TCP 10BASE-T/100BASE-TX network
- 6 **BMX P34 2020** processor: An RJ45 connector for the Modbus serial link or character mode link (RS 232C/RS 485, 2-wire, non-isolated)
- 7 **BMX P34 2030** processor: A 9-way SUB-D connector for the integrated CANopen master bus

On the back panel there are two rotary switches for assigning the IP address. There are three ways to define this assignment:

- Address set by the position of the two switches
- Address set by the application parameters
- Address set by the Ethernet Modbus/TCP BOOTP server

USB terminal port

The USB terminal port 3 with a data rate of 12 Mbit/s is compatible with the Unity™ Pro programming software and the OPC® Factory Server (OFS).

BMX P34 ●0●0 processors can be connected to a USB bus comprised of several peripheral devices, however:

- Only one processor must be connected to the USB bus.
- No device on the USB bus can be controlled by the PLC (modem, printer).

(1) Magelis® graphic terminals XBT GT/GK/GTW with USB port and Vijeo® Designer™ configuration software version ≥ 4.5. Please consult the "Human/Machine Interfaces" catalog.

Memory structure

BMX P34 1000/2000 processor with memory card supplied as standard

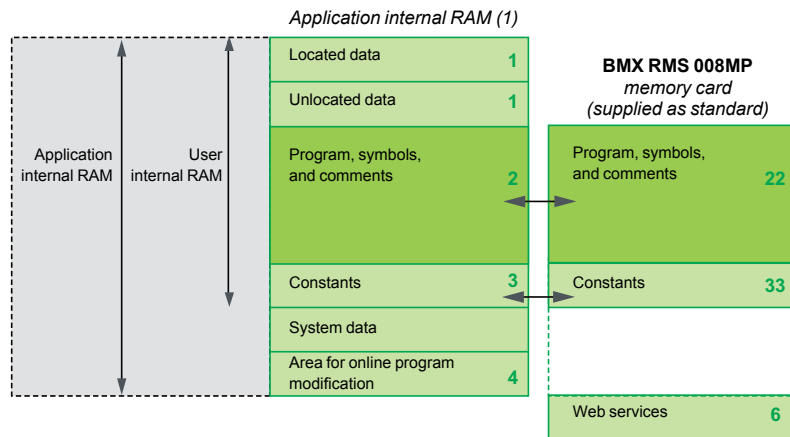

Application internal RAM

The application memory is divided into memory areas, physically distributed in the Modicon® M340™ processor's internal RAM:

- 1 Application data area may be one of two 2 possible types:
 - Located data: corresponding to the data defined by an address (for example %MW237) with which a symbol can be associated (for example, Counter_reject).
 - Unlocated data: corresponding to data defined only by a symbol. The use of unlocated data eliminates the restrictions of managing the memory location since the addresses are assigned automatically. It also allows data to be structured and re-used.

This data area is backed up automatically when the PLC is turned off by duplicating its contents in a 256 Kbyte non-volatile internal memory integrated in the processor. It is also possible to back up this memory at any time with a user program.

- 2 Program, symbols and comments area: For program, this area contains the executable binary code and IEC source code.
- 3 Constants area: This area supports the constant located data (%KWi).
- 4 Area for online program modification, see page 1/7.

The user can choose to transfer the source data to the executable program in the PLC. The fact of having the program source in the PLC means that, when an empty programming terminal is connected to the PLC, the elements needed to debug or upgrade this application can be restored to the terminal. Comments and animation tables can be excluded from the data embedded in the PLC.

Memory card

Modicon M340 processors are supplied as standard with an SD (*Secure Digital*) type Flash memory card. This memory card is intended for backing up the program, symbols, and comments area 2 and the constants area 3.

- 22, 33 Duplication areas: Duplication and retrieval (on return of power) operations are managed automatically by the system and are therefore transparent to the user.
- 6 Area for standard Web services: For **BMX P34 2020/2030** processors with integrated Ethernet Modbus®/TCP port, this area of 2 Mb is dedicated to standard Web services (Transparent Ready® Class B10). See page 3/4.

Formatted by Schneider Electric and supplied with each processor, this card is referenced as a replacement part **BMX RMS 008MP**.

(1) For different memory area sizes, see Specifications, on page 1/8.

Memory structure (continued)

BMX P34 20●0 processor with BMX RMS 008MPF memory card

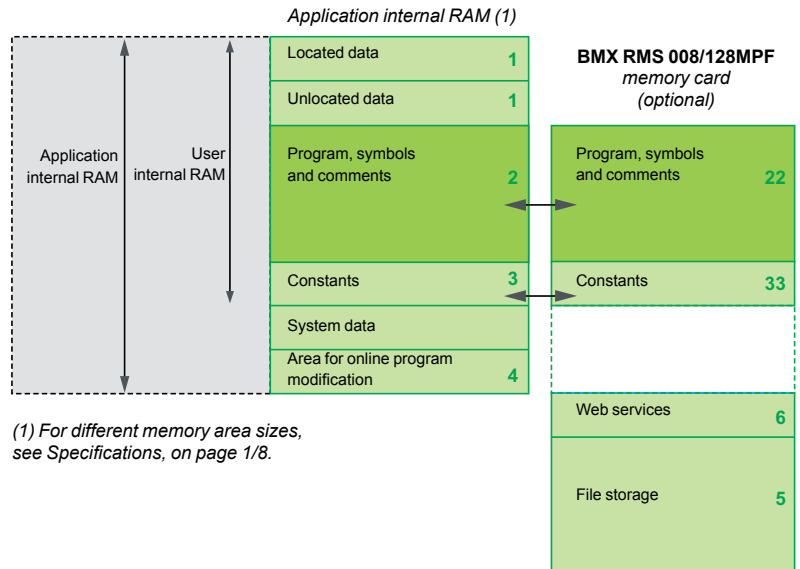

(1) For different memory area sizes, see Specifications, on page 1/8.

BMX RMS 008/128MPF optional memory card

Instead of the **BMX RMS 008MP** memory card, the **BMX RMS 008/128MPF** memory card can be slotted in **BMX P34 2000/2010/2020/2030** processors.

With the four above mentioned processors, this card also offers (in addition to the features of the **BMX RMS 008MP** card supplied as standard described on page 1/6):

- 5 File storage area: This area of max. 8 Mb max. (with **BMX RMS 008MPF** card) or 128 Mb max. (with **BMX RMS 128MPF** card) allows:
 - Via FTP, hosting any user-defined Word™, Excel™, PowerPoint™ or Acrobat Reader™ document (for example, maintenance manuals, wiring diagrams, etc)
 - Via EFBs user function blocks storage of the additional data (for example, production data, manufacturing recipes, etc)

The Unity™ Pro programming software assists the application designer with managing the structure and memory space occupation of the Modicon® M340™ automation platform.

Protecting the application

It is possible to prohibit access to the application (in terms of reading or modifying the program) by only loading the executable code to the PLC.

Additionally, a memory protection bit set in configuration mode is also available to prevent any program modification via the programming terminal or downloads.

Modifying the program in online mode

As with Modicon® Premium™ and Quantum™ platforms with Unity™ Pro software, the online program modification function is available on the Modicon M340 automation platform. The option of adding or modifying the program code and data in different places in the application in a single modification session helps to ensure that the modification is homogenous and consistent with the controlled process.

The application's internal RAM area 4 authorizes these program modification or addition sessions while observing the recommendation to structure the application program in several, reasonably-sized sections.

The Modicon® M340™ Micro-PLC is designed to conform with the main national and international standards relating to electronic devices for industrial control systems. See "Standards, certifications and environmental conditions" on pages 6/2 to 6/5.

1

Specifications and performance

Processor			Standard BMX P34 1000	Performance BMX P34 2000	BMX P34 2010	BMX P34 2020	BMX P34 2030	
Maximum configuration	No. of racks	4, 6, 8 or 12 slots	2	4				
	Max. number of slots for processor and modules (excluding power supply module)		24	48				
Functions	Max. no. (1)	Discrete I/O	512	1,024				
		Analog I/O	128	256				
		Control channels	Programmable loops (via CONT-CTL process control EFB library)					
		Application-specific channels	20	36				
		Motion control	Counter modules 2 channels (60 kHz) or 8 channels (10 kHz) Motion control module 2 channels with PTO outputs "Pulse Train Output" for servo drives Serial link integrated in processor (except BMX P34 2030 model)					
				Independent axes on CANopen bus (via MFB library)		Independent axes on CANopen bus (via MFB library)		
	Integrated connections	Ethernet Modbus®/TCP				1 RJ45 port, 10/100 Mbit/s, with Transparent Ready® class B10 standard web server		
		CANopen master bus			1 (9-way SUB-D)		1 (9-way SUB-D)	
		Serial link		1 RJ45 port, Modbus master/slave RTU/ASCII or character mode (non-isolated RS 232C/RS 485), 0.3...38.2 Kbit/s				
		USB port		1 slave port, 12 Mbit/s				
Communication module	Ethernet Modbus/TCP 10/100 Mbit/s		1 RJ45 port, with: - Transparent Ready class B30 standard web server with BMX NOE 0100 module - Transparent Ready class C30 configurable web server with BMX NOE 0110 module					
Real-time clock	RTC		Yes. Backed up: Typical 6 weeks during 5 years and 4 weeks during 10 years, at 40°C (operating temperature), 30°C (storage temperature)					
Internal user RAM	Total capacity	Kb	2,048	4,096				
	Program, constants and symbols	Kb	1,792	3,584				
	Data	Kb	128	256				
Memory card	Supplied as standard (reference BMX RMS 008MP)		Backup of program, constants, symbol and data					
					Activation of standard web server, class B10 Standard web server area 2 Mb			
	To be ordered separately (BMX RMS 008MPF or BMX RMS 008MPF reference)			Backup of program, constants, symbol and data				
			File storage, min. 8 Mb or 128 Mb depending model card(3)					
				Activation of standard web server, class B10 Standard web server area 2 Mb				
Maximum size of object areas	Located internal bits	Maximum	bits	16,250%Mi	32,464%Mi			
		Dedetected fault	bits	256%Mi	512%Mi			
	Located internal data	Maximum	Bytes	32,464%MWi internal words, 32,760%KW constant words				
		Dedetected fault	Bytes	512%MWi internal words, 128%KW constant words				
	Max. unlocated internal data	Kb	128 (2)	256 (2)				
Application structure	Master task		1 cyclic or periodic					
	Fast task		1 periodic					
	Auxiliary tasks		-					
	Event tasks		32 (including 2 with priority)	64 (including 2 with priority)				
Execution time for one instruction	Boolean		µs	0.18	0.12			
	On words or fixed point arithmetic	% MS single-length	µs	0.38	0.25			
		% MD double-length	µs	0.26	0.17			
	On floating points	% MF	µs	1.74	1.16			
No. of Instructions executed per ms	100% Boolean	Kinst/ms	5.4	8.1				
	65% Boolean and 35% fixed arithmetic	Kinst/ms	4.2	6.4				
System overhead	Master task	ms	1.05	0.70				
	Fast task	ms	0.20	0.13				
Power consumption	With 24 V ~ voltage		mA	72	72	90	95	135

(1) Only affects in-rack modules. The remote I/O on the CANopen bus is not included in these maximum numbers.

(2) Deduct the size of the located data (internal bits and data) and the configuration data from this value.

(3) BMX RMS 008MFP has the ability to use up to 14 Mb if the operating system update via OS-Loader software is not used.



BMX P34 1000



BMX P34 2000



BMX P34 2010/2030



BMX P34 2020



BMX RMS 008/128MPF



BMX XCA USB H0

BMX P34 Modicon M340 processors

Modicon® M340™ processor modules are supplied with the **BMX RMS 008MP** flash memory card. This card performs the following actions transparently:

- Backing up the application (program, symbols and constants) supported in the processor internal RAM that were not backed up
- Activating the Transparent Ready® class B10 standard web server with **BMX P34 2020/2030** performance processors.

This card can be replaced by a **BMX RMS 008MPF** or **BMX RMS 128MPF** card featuring a file storage option.

I/O capacity	Memory capacity	Max. no. of network modules	Integrated communication ports	Reference (3)	Weight kg
Standard BMX P34 10, 2 racks					
512 discrete I/O 128 analog I/O 20 application-specific channels	2,048 Kb integrated	1 Ethernet Modbus®/ TCP network	Modbus serial link	BMX P34 1000	0.200

Performance BMX P34 20, 4 racks					
1,024 discrete I/O 256 analog I/O 36 application-specific channels	4,096 Kb integrated	2 Ethernet Modbus/ TCP networks	Modbus serial link	BMX P34 2000	0.200
			Modbus serial link CANopen bus	BMX P34 2010	0.210
			Modbus serial link Ethernet network	BMX P34 2020	0.205
			Ethernet network CANopen bus	BMX P34 2030	0.215

Memory cards

Description	Processor compatibility	Capacity	Reference	Weight kg
Flash memory cards (1)	BMX P34 2000	8 Mb / 8 Mb files	BMX RMS 008MPF	0.002
	BMX P34 2010 BMX P34 2020 BMX P34 2030	8 Mb / 128 Mb files	BMX RMS 128MPF	0.002

Separate parts

Description	Use		Length	Reference	Weight kg
	From	To USB port type A			
Terminal port/USB cordsets	Mini B USB port	PC terminal	1.8 m	BMX XCA USB H018	0.065
	on the Modicon® M340™ processor	Magelis® XBT GT/GK and XBT GTW graphic terminal	4.5 m	BMX XCA USB H045	0.110

Replacement parts

Description	Use	Processor compatibility	Reference	Weight kg
Flash memory card 8 Mb	Supplied as standard with each processor that is used for: <ul style="list-style-type: none"> - Backing up program, constants, symbol and data - Activating class B10 web server 	BMX P34 1000 / 20●0	BMX RMS 008MP	0.002

(1) As replacement for the memory card supplied as standard with each processor that is used for:

- Backing up program, constants, symbol and data
- File storage
- Activating class B10 web server

Introduction

BMX CPS ●●●0 power supply modules provide the power supply for each **BMX XBP ●●00** rack and the modules installed on it.

There are two types of power supply modules:

- Power supply modules for AC supplies
- Power supply modules for DC supplies

Description

The power supply module is selected according to:

- The electrical line supply: 24 V $\overline{\text{---}}$, 48 V $\overline{\text{---}}$ or 100...240 V \sim
- The required power (see the power consumption table on page 6/13) (1)

BMX CPS ●●●0 power supply modules have the following on the front panel :

- 1 A display block comprised of:
 - OK LED (green), lit if rack voltages are present and correct
 - 24 V LED (green), lit when the sensor voltage is present (for BMX CPS 2000/3500 AC power supply modules only)
- 2 A pencil-point RESET pushbutton for a cold restart of the application
- 3 A 2-way connector that can take a removable terminal block (screw or spring-type) for connecting the alarm relay
- 4 A 5-way connector that can take a removable terminal block (screw or spring-type) for connecting the following:
 - $\overline{\text{---}}$ or \sim line supply
 - protective earth ground
 - dedicated 24 V $\overline{\text{---}}$ power supply for the input sensors (for **BMX CPS 2000/3500** AC power supply modules only)

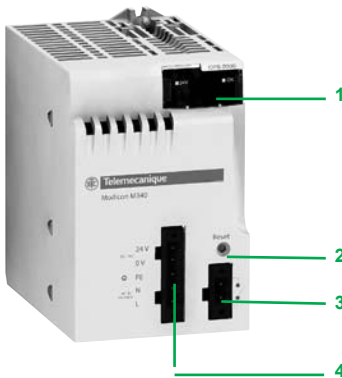

Included in the power supply modules: Set of two cage clamp removable terminal blocks (5-way and 2-way) **BMX XTS CPS10**.

To be ordered separately (if necessary): Set of two spring-type removable terminal blocks (5-way and 2-way) **BMX XTS CPS20**

(1) This power consumption calculation for the rack can also be performed by the Unity™ Pro programming software.

Functions

Alarm relay

The alarm relay located in each power supply module has a volt-free contact accessible from the front of the 2-way connector.

The operating principle is as follows:

In normal operation, with the PLC in RUN, the alarm relay is activated and its contact is closed (state 1).

The relay de-energizes and its associated contact opens (state 0) whenever the application stops, even partially, due to any of the following:

- Occurrence of a detected blocking fault
- Incorrect rack output voltages
- Loss of supply voltage

RESET push-button

The power supply module in each rack has a RESET button on the front panel; when activated, this triggers an initialization sequence for the processor and the rack modules it supplies.

Pressing this pushbutton triggers a sequence of service signals that is the same as:

- A power break when the pushbutton is pressed
- A power-up when the pushbutton is released

In terms of the application, these operations represent a cold start (forcing the I/O modules to state 0 and initializing the processor).

Sensor power supply

The **BMX CPS 2000/3500** AC power supply modules have an integrated 24 V $\overline{\text{---}}$ voltage supply for powering the input sensors. Connection to this sensor power supply is via the 5-way connector on the front panel.

The power available on this 24 V $\overline{\text{---}}$ voltage depends on the power supply model (0.45 or 0.9 A) (see Specifications on page 1/12).

Specifications			
⎓ Power supply module			
Primary	Voltage	Nominal	V 24 --- isolated
		Limit (ripple included)	V 18...31.2 ---
	Current	Input nominal I rms	A 1 at 24 V ---
Initial power-up at 25°C (1)			V 24 ---
		I inrush	A 30
		I ² t on activation	A²s ≤ 0.6
		It on activation	As ≤ 0.15
Micro-break duration	Line (accepted)	ms ≤ 1	
Integrated protection		With internal fuse (not accessible)	
Secondary	Useful power	Max.	W 16.8
	3.3 V --- voltage (2)	Nominal voltage	V 3.3
		Nominal current	A 2.5
		Typical power	W 8.3
	24 V rack --- voltage (3)	Nominal voltage	V 24 ---
		Nominal current	A 0.7
		Typical power	W 16.8
	Integrated protection on the voltages (4)		Yes, against overloads, short-circuits and overvoltages
Max. dissipated power		W 8.5	
Max. length of power supply cable	Copper wires with 1.5 mm ² cross-section		m 20
	Copper wires with 2.5 mm ² cross-section		m 30
Insulation	Dielectric strength	Primary/secondary and primary/ground	V rms 1,500 - 50 Hz for 1 min at an altitude of 0...4,000 m
	Insulation resistance	Primary/secondary and primary/ground	MΩ ≥ 10
~ Power supply module			
Primary	Voltages	Nominal	V 100...240 ~
		Limit (ripple included)	V 85...264 ~
	Frequencies	Nominal/limit	Hz 50-60/47-63
	Power	Apparent	VA 70
	Current	Input nominal I rms	A rms 0.61 at 115 V ~; 0.31 at 240 V ~
Initial power-up at 25°C (1)			V 120 ~
		I inrush	A ≤ 30
		I ² t on activation	A²s ≤ 0.5
		It on activation	As 0.03
Micro-break duration	Line (accepted)	ms ≤ 10	
Integrated protection		With internal fuse (not accessible)	
Secondary	Useful power	Max. overall	W 20
		Max. on 3.3 V --- and 24 V --- rack output voltages	W 16.8
	3.3 V --- voltage (2)	Nominal voltage	V 3.3
		Nominal current	A 2.5
		Power (typical)	W 8.3
	24 V rack --- voltage (3)	Nominal voltage	V 24 ---
		Nominal current	A 0.7
		Typical power	W 16.8
	24 V --- sensor voltage (4)	Nominal voltage	V 24 ---
		Nominal current	A 0.45
Typical power		W 10.8	
Integrated protection on the voltages (5)		Yes, against overloads, short-circuits and overvoltages	
Maximum dissipated power		W 8.5	
Insulation	Dielectric strength	Primary/secondary (24 V/3.3 V)	V rms 1500
		Primary/secondary (sensor 24 V)	V rms 2300
		Primary/ground	V rms 1500
		24 V sensor output/ground	V rms 500
	Insulation resistance	Primary/secondary and primary/ground	MΩ ≥ 100

(1) These values should be taken into account when starting several devices simultaneously and when sizing protection devices.
 (2) 3.3 V --- voltage for the I/O module logic power supply
 (3) 24 V --- rack voltage for the I/O module power supply and the processor
 (4) 24 V --- sensors output for the sensor power supply
 (5) Protected by fuse

Modicon® M340™ automation platform

Power supply modules



BMX CPS 2010 / 3020



BMX CPS 2000 / 3500

References

Each **BMX XBP ●●00** rack must be equipped with a power supply module. These modules are inserted in the first two slots of each rack (marked CPS).
The power required to supply each rack depends on the type and number of modules installed in the rack. It is therefore necessary to draw up a power consumption table rack by rack to determine the **BMX CPS ●●●0** power supply module most suitable for each rack (see page 6/13).

Power supply modules (1)

Line supply	Available power (2)			Total	Reference	Weight kg
	3.3 V $\overline{\text{---}}$ (3)	24 V rack $\overline{\text{---}}$ (3)	24 V sensor $\overline{\text{---}}$ (4)			
24 V $\overline{\text{---}}$ isolated	8.3 W	16.8 W	–	16.8 W	BMX CPS 2010	0,290
24...48 V $\overline{\text{---}}$ isolated	15 W	31.2 W	–	31.2 W	BMX CPS 3020	0,340
100...240 V \sim	8.3 W	16.8 W	10.8 W	20 W	BMX CPS 2000	0.300
	15 W	31.2 W	21.6 W	36 W	BMX CPS 3500	0.360

Separate parts

Description	Composition	Type	Reference	Weight kg
Set of 2 removable connectors	One 5-way terminal block and one 2-way terminal block	Spring-type	BMX XTS CPS20	0.015

Replacement parts

Description	Composition	Type	Reference	Weight kg
Set of 2 removable connectors	One 5-way terminal block and one 2-way terminal block	Cage clamp	BMX XTS CPS10	0.020

- (1) Includes the set of 2 cage clamp removable connectors **BMX XTS CPS10**.
 (2) The sum of the absorbed power on each voltage (3.3 V $\overline{\text{---}}$ and 24 V $\overline{\text{---}}$) should not exceed the total power of the module. See the Power consumption table on page 6/13.
 (3) 3.3 V $\overline{\text{---}}$ and 24 V rack $\overline{\text{---}}$ voltages for powering Modicon® M340™ PLC modules
 (4) 24 V sensor $\overline{\text{---}}$ voltage for powering the input sensors (voltage available via the 2-way removable connector on the front panel)

Introduction

BMX XBP ●●00 racks are the basic element of the Modicon® M340™ automation platform in a single-rack and multi-rack configurations.

These racks perform the following functions:

- Mechanical function: They are used to install all the modules in a PLC station (power supply, processor, discrete I/O, analog and application-specific I/O). These racks can be mounted on a panel, plate or DIN rail:
 - Inside enclosures
 - On machine frames, etc.
- Electrical function: The racks incorporate a Bus X (owner bus). They are used to:
 - Distribute the power supplies required for each module in the same rack
 - Distribute data and service signals for the entire PLC station
 - Hot swap modules during operation

Description

BMX XBP ●●00 racks are available in 4, 6, 8 or 12-slot versions, and comprise:

- 1 A metal frame that performs the following functions:
 - Holds the Bus X electronic card and protects it against EMI and ESD type interference
 - Holds the modules
 - Gives the rack mechanical rigidity
- 2 A ground terminal for grounding the rack
- 3 4 holes for mounting the rack on a frame. These holes are big enough for M6 screws.
- 4 2 mounting points for the shielding connection bar
- 5 Tapped holes to take each module locking screw
- 6 A connector for an expansion module, marked **XBE**.
- 7 40-way female ½ DIN connectors forming the electrical connection between the rack and each module, marked **CPS, 00...11** (when the rack is delivered, each connectors are protected by covers that should be removed before inserting the modules).
- 8 Slots for anchoring the module pins.

To be ordered separately:

BMX XSP ●●00 cable shielding connection kit, used to protect against electrostatic discharge when connecting the shielding of cordsets for connecting:

- Analog, counter and motion control modules,
- A Magelis® XBT operator interface to the processor (via **BMX XCA USBH0●●** shielded USB cable)

The cable shielding connection kit **BMX XSP ●●00** is comprised of:

- 9 A metal bar that takes the clamping rings
- 10 Two sub-bases to be mounted on the rack
- 11 Not included on the shielding connection kit spring clamping rings **STB XSP 30●0** (sold in packs of 10, 1.5...6 mm² or 5...11 mm²).

Function

Addressing modules in a single-rack configuration (1)

Each rack must contain a power supply module and a processor module.

Inserting different modules in the rack:

- The power supply module always occupies the **CPS** slot.
- The processor module must always be installed in slot **00**.
- Its I/O modules and application-specific modules are installed in slot **01** to slot:
 - **03** with a 4-slot rack
 - **05** with a 6-slot rack
 - **07** with an 8-slot rack
 - **11** with a 12-slot rack

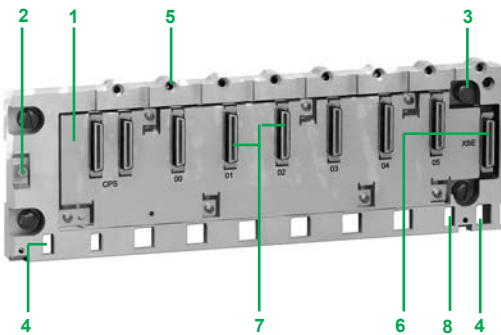

Rack 6 slots BMX XBP 0600

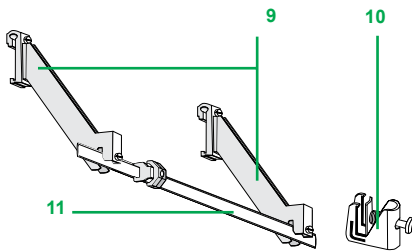

Shielding connection kits

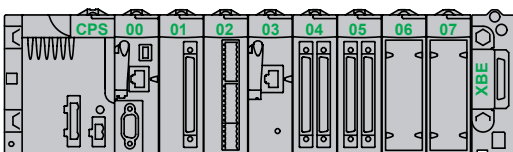

Example of installation with 8-slot rack

(1) Multi-rack configuration with extension rack module **BMX XBE 1000** (slot **XBE**).
See page 1/16.

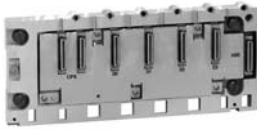

BMX XBP 0400

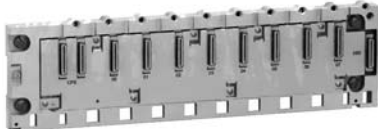

BMX XBP 0800

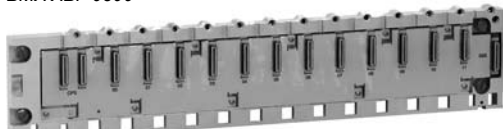

BMX XBP 1200

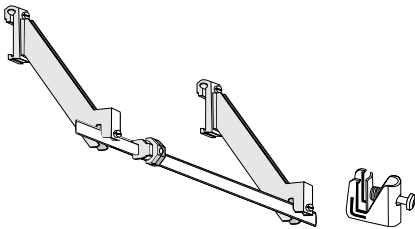

BMX XSP ●●00

STB XSP 30●0

Racks

Description	Type of module to be inserted	No. of slots (1)	Reference	Weight kg
Racks	BMX CPS power supply,	4	BMX XBP 0400	0.630
	BMX P34 processor, I/O modules and	6	BMX XBP 0600	0.790
	application-specific modules (counter, motion control and communication)	8	BMX XBP 0800	0.950
		12	BMX XBP 1200	1.270

Accessories

Description	For use with	Unit reference	Weight kg
Shielding connection kits comprised of: - a metal bar - two sub-bases	BMX XBP 0400 rack	BMX XSP 0400	0.280
	BMX XBP 0600 rack	BMX XSP 0600	0.310
	BMX XBP 0800 rack	BMX XSP 0800	0.340
	BMX XBP 1200 rack	BMX XSP1200	0.400

Spring clamping rings Sold in lots of 5	Cables with 1.5...6 mm ² cross-section	STB XSP 3010	0.050
	Cables with 5...11 mm ² cross-section	STB XSP 3020	0.070

Protective covers (replacement parts) Sold in lots of 5	Unoccupied slots on BMX XBP ●●00 rack	BMX XEM 010	0.005
--	---------------------------------------	--------------------	-------

(1) Number of slots taking the processor module, I/O modules and application-specific modules (excluding power supply module).

Dimensions, mounting

BMX XBP

Common side view

Front view

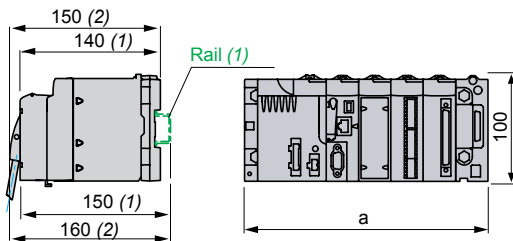

	a
BMX XBP 0400	242.4
BMX XBP 0600	307.6
BMX XBP 0800	372.8
BMX XBP 1200	503.2

(1) With removable terminal block (cage, screw or spring).
(2) With FCN connector.

Mounting the racks

On AM1 PA and AM3 PA pre-slotted plate

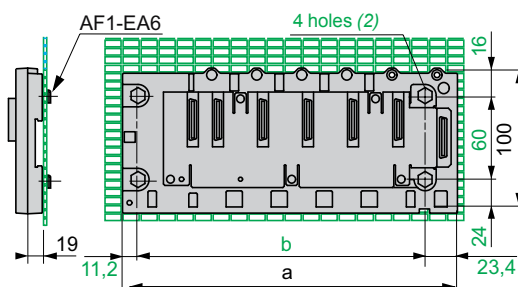

	a	b
BMX XBP 0400	242.4	207.8
BMX XBP 0600	307.6	273
BMX XBP 0800	372.8	338.2
BMX XBP 1200	503.2	468.6

- (1) On AM1 ED rail: 35 mm wide, 15 mm deep Only possible with BMX XBP 0400/0600/0800 rack
- (2) For panel-mounting: The diameter of the mounting holes must be sufficient to accept M4, M5, M6 screws (4.32 to 6.35 mm).

Installation rules

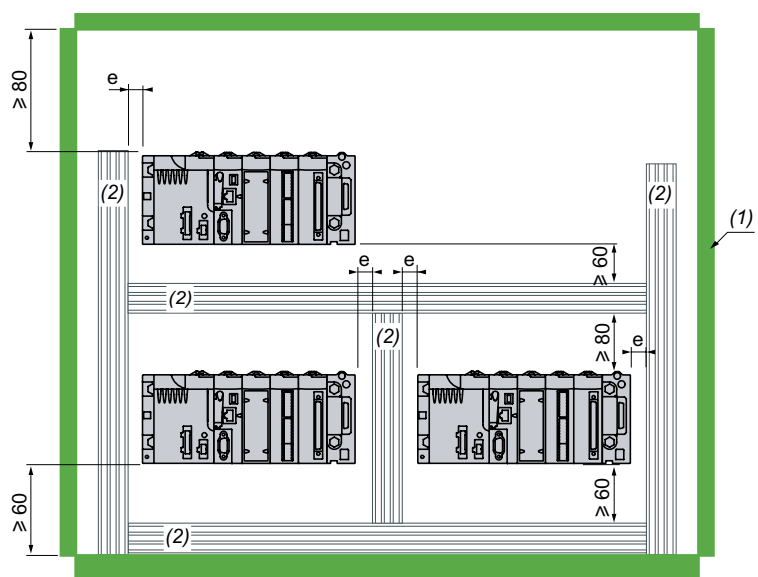

e ≥ 3 mm

- (1) Equipment or enclosure.
- (2) Cable ducting or clip.

1

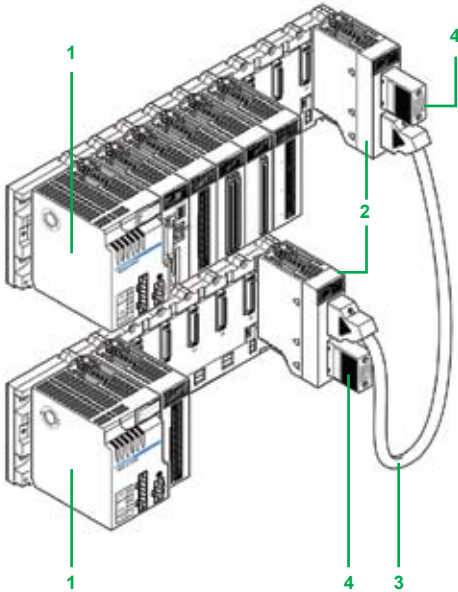

Constitution of a multi-rack configuration

Using **BMX XBP ●●●0** racks, a multi-rack configuration is comprised of up to:

- 2 racks for a station with BMX P34 1000 processor
- 4 racks for a station with BMX P34 2●●0 processor

Each rack is equipped with:

- 1 ABMX CPS ●●●0 power supply.
- 2 ABMX XBE 1000 extension rack module. This module inserted on the right of the rack (slot marked **XBE**, see page 43402-EN/2) does not occupy 00...11 slots of the rack (4, 6, 8 or 12 slots are available).
- 3 The BMX XBE 1000 extension rack modules are connected to each other by bus X extension cordsets.

Bus X

The racks distributed on bus X are connected to each other via **3** bus X extension cordsets whose total length is **30 m maximum**.

The racks are connected to each other using **BMX XBC ●●0K (1)** bus X extension cordsets that are connected to one of the **7** and **8** two 9-way SUB-D connectors on each **2** BMX XBE 1000 extension rack module.

Line terminators **4**

The two BMX XBE 1000 extension rack modules located at the ends of the line must have a **TSX TLY EX** line terminator **4** fitted on the unused 9-way SUB-D type connector.

Note: The processor module is always positioned in the rack address 0. However on a bus X chaining, the order of racks does not affect the operation. For example, the chaining order can be 0-1-2-3, 2-0-3-1, 3-1-2-0, and so on.

Description

The BMX XBE 1000 extension rack module has the following on the front panel:

- 5 Safety screw for locking the module in its slot **XBE**.
- 6 A display block comprised of 5 LEDs:
 - RUN LED (green): module in operation,
 - COL LED (red): each rack has the same address or the rack address 0 is not equipped of **BMX P34 ●●●0** processor module,
 - 0, 1, 2 and 3 LEDs (green): 0, 1, 2 or 3 rack address.
- 7 A 9-way female SUB-D connector, marked bus X for to connect a **3** bus X cordset from the previous rack or, if the first rack, for line termination A/ included in the **4** TSX TLY EX lot.
- 8 A 9-way female SUB-D connector, marked bus X for to connect a **3** bus X cordset to next rack or, if the last rack, for line termination /B included in the **4** TSX TLY EX lot.

On the right side

Access to 3 micro-switches for defining the rack address: 0...3.

Installation rules of **BMX XBP ●●●0** racks
Installation rules in cabinet, see page 1/15.

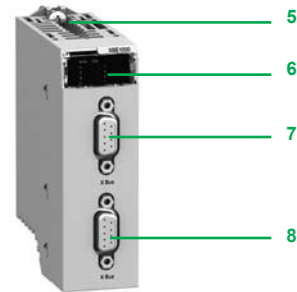

(1) **BMX XBC ●●0K** daisy chaining cordsets length 0.8 m, 1.5 m, 3 m, 5 m or 12 m with angled connectors or **TSX CBY ●08K** length 1 m, 3 m, 5 m, 12 m, 18 m or 28 m with straight connectors



BMX XBE 1000

Bent connector equipping the
BMX XBS ●●●K cordsets

TSX TLY EX

Extension rack

Description	Use	Reference	Weight kg
Extension rack module for Modicon® M340™	Standard module for each rack (XBE slot), allows the connection of extension racks: - 2 max. with BMX P34 1000 processor module - 4 max. with BMX P34 20●0 processor module	BMX XBE 1000	0.178
Extension rack kit	Kit for configuration with 2 racks including: - 2 BMX XBE 1000 extension rack modules - 1 BMX XBC 008K daisy chaining cordset length 0.8 m - 1 TSX TLY EX line terminators (lot of 2)	BMX XBE 2005	0.700

Cordsets and connecting accessories

Description	Use	Composition	Type of connector	Length	Reference	Weight kg
Daisy chaining cordsets bus X (total length 30 m max.)	Between BMX XBE 1000 extension rack modules	2 x 9-way SUB-D 9 connectors	Bent	0,8 m	BMX XBC 008K	0.165
				1,5 m	BMX XBC 015K	0.250
				3 m	BMX XBC 030K	0.420
				5 m	BMX XBC 050K	0.650
				12 m	BMX XBC 120K	1.440
			Straight	1 m	TSX CBY 010K	0.160
				3 m	TSX CBY 030K	0.260
				5 m	TSX CBY 050K	0.360
				12 m	TSX CBY 120K	1.260
				18 m	TSX CBY 180K	1.860
				28 m	TSX CBY 280K	2.860

Cable on reel	Length to be fitted with TSX CBY K9 connectors	Cable with free ends, 2 line testers	–	100 m	TSX CBY 1000	12.320
---------------	--	--------------------------------------	---	-------	---------------------	--------

Description	Use	Composition	Sold in lots of	Reference	Weight kg
Line terminators	Compulsory on the BMX XBP ●●●0 end daisy chaining	2 x 9-way SUB-D connectors labelled A/ and /B	2	TSX TLY EX	0.050
Bus X straight connectors	For TSX CBY 1000 cable ends	2 x 9-way straight SUB-D connectors	2	TSX CBY K9	0.080
Installation of connectors	Mounting for TSX CBY K9 connectors	2 crimping pliers, 1 pen (1)	–	TSX CBY ACC 10	–

(1) Installation of connectors on the cable also required .

Introduction

The Modicon® M340™ packs offer is designed to provide compact solutions with optimized cost. These 5 pre-assembled packs, built around the BMX P34 1000 Standard processor, include one non-extendable rack (4 or 6 slots) with an AC or DC power supply module and discrete I/O modules.

Note: The BMX FTB 2000 20-way removable terminals blocks of discrete I/O modules are included but delivered in separate packaging.

Description

Modicon® M340™ packs with ~ 100...240 V power supply (terminal blocks)

The BMX PAM 48000/48200 pre-assembled packs comprise:

- 1 One non-extendable rack 4 or 6 slots, depending on model.
- 2 One BMX CPS 2000 ~ 100...240 V, 20 W power supply module with a set of 2 cage clamp connectors.
- 3 One BMX P34 1000 Standard processor module (with Modbus® serial link).
- 4 2 BMX DDI 1602 modules of 16 isolated inputs ~ 24 V, positive logic and, delivered non-mounted, 2 BMX FTB 2000 20-way removable terminal blocks (cage clamp).
- 5 One BMX DRA 1605 module of 16 relay outputs and, delivered non-mounted, one BMX FTB 2000 20-way removable terminal block (cage clamp).
- 6 2 free slots (with rack 6 slots).

BMX PAM 48000

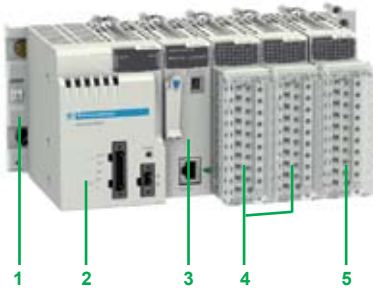

Modicon M340 packs with ~ 24 V power supply (terminal blocks)

The BMX PDM 48000/48200 pre-assembled packs comprise:

- 1 One non-extendable rack 4 or 6 slots, depending on model..
- 2 One BMX CPS 2010 ~ 24 V, 16.8 W power supply module with a set of 2 cage clamp connectors.
- 3 One BMX P34 1000 Standard processor module (with Modbus serial link).
- 4 2 BMX DDI 1602 modules of 16 isolated inputs ~ 24 V, positive logic and, delivered non-mounted, 2 BMX FTB 2000 20-way removable terminal blocks (cage clamp).
- 5 One BMX DDO 1602 module of 16 solid state outputs ~ 24 V and, delivered non-mounted, one BMX FTB 2000 20-way removable terminal block (cage clamp)..
- 6 2 free slots (with rack 6 slots).

BMX PDM 48200



Modicon M340 packs with ~ 24 V power supply (version with connectors)

The BMX PDM 64100 pre-assembled pack comprises:

- 1 One non-extendable rack 4 slots,
- 2 One BMX CPS 2010 ~ 24 V, 16.8 W power supply module with a set of 2 cage clamp connectors.
- 3 One BMX P34 1000 Standard processor module (with Modbus serial link).
- 4 One BMX DDI 3202K module of 32 isolated inputs ~ 24 V, positive logic, connection by one 40-way connector.
- 5 One BMX DDO 3202K module of 32 solid state outputs ~ 24 V 0.1 A with 40-way connector.
- 6 One free slot.

To be ordered separately:

- 2 **BMX FCW/FCC ●●3** preformed cordsets with one connector 40-way.

Modicon® M340™ automation platform

Modicon M340 packs

References

These pre-assembled packs are comprised of:

- One non-extendable rack 4 or 6 slots (except power supply module).
- One BMX CPS 2000 AC power supply or BMX CPS 2010 DC power supply with a set of 2 cage clamp connectors.
- One BMX P34 1000 processor module with Modbus® serial link and USB port for a programming terminal (or Magelis® XBT GT/GK/GTW advanced panel).

Depending on model:

- The discrete I/O modules with cage clamp 20-way terminal blocks or 40-way connectors.
- 0, 1 or 2 free slot(s).

Packs with ~ 110...240 V power supply

No. of slots	Discrete I/O modules			No. free slots	Reference	Weight kg
	Inputs	Outputs	Connection			
4	2 x BMX DDI 1602 16 channels ~ 24 V	1 x BMX DRA 1605 16 relays	3 x BMX FTB 2000 cage clamp terminal blocks	0	BMX PAM 48000	2.600
6	2 x BMX DDI 1602 16 channels ~ 24 V	1 x BMX DRA 1605 16 relays	3 x BMX FTB 2000 cage clamp terminal blocks	2	BMX PAM 48200	2.900



BMX PAM 48000

Packs with ~ 24 V power supply

No. of slots	Discrete I/O modules			No. free slots	Reference	Weight kg
	Inputs	Outputs	Connection			
4	2 x BMX DDI 1602 16 channels ~ 24 V	1 x BMX DDO 1602 16 channels ~ 24 V/0,5 A	3 x BMX FTB 2000 cage clamp terminal blocks	0	BMX PDM 48000	2,600
6	2 x BMX DDI 1602 16 channels ~ 24 V	1 x BMX DDO 1602 16 channels ~ 24 V/0,5 A	3 x BMX FTB 2000 cage clamp terminal blocks	2	BMX PDM 48200	2.900
4	1 x BMX DDI 3202K 32 channels ~ 24 V	1 x BMX DDO 3202K 32 channels ~ 24 V/0,1 A	2 x 40-way connectors (1)	1	BMX PDM 64100	2.200



BMX PDM 48200

(1) Preformed cordsets with 40-way connectors (and flying leads or HE10 connectors) **BMX FCW/FCC ●●3** preformed cordsets with one connector 40-way.

2.1 - Discrete I/O modules

Discrete I/O modules selection guide	2/2
■ Introduction, description	2/6
■ Functions	2/8
■ Specifications	2/10
■ References	2/16
■ Connections	2/18

2.2 - Analog I/O modules and process control

Analog I/O modules selection guide	2/22
■ Analog I/O modules	
□ Introduction, description	2/24
□ Functions	2/26
□ Specifications	2/28
□ References	2/31
□ Connections	2/32
■ Programmable process control	2/34

2.3 - Distributed I/O

IP 67 & IP 20 distributed I/O selection guide	2/36
--	-------------

2.4 - Application-specific modules and MFB motion control

■ Counter modules	
□ Introduction, description	2/38
□ Functions	2/39
□ Specifications	2/42
□ References	2/43
□ Connections	2/44
■ Motion control module	
□ Introduction, description	2/46
□ Functions	2/47
□ Specifications	2/48
□ References	2/49
□ Connections	2/50
■ Motion Function Blocks	
□ Introduction	2/52
□ Functions	2/52
□ Setup	2/53

Modicon® M340™ automation platform

Discrete I/O modules

Input modules and mixed I/O modules

Applications

16-channel input modules

Connection via cage clamp, screw clamp or spring-type removable terminals

2



Type		---	--- or ~	~	
Voltage		24 V	48 V	24 V	48 V 100...120V
Modularity (Number of channels)		16 isolated channels			
Connection		Via BMX FTB 2000/2010/2020 20-way cage clamp, screw clamp or spring-type removable terminals			
Isolated inputs	IEC/EN 61131-2 conformity	Type 3	Type 1	Type 1 (~)	Type 3
	Logic	Positive		Negative	
	Sensor compatibility in accordance with standard IEC/EN 60947-5-2	2-wire ---, 3-wire --- PNP any type		2-wire ---/~, 3-wire --- PNP or NPN any type	
Isolated outputs	Fallback	-			
	IEC/EN 61131-2 conformity	-			
	Protection	-			
	Logic	-			
Module		BMX DDI 1602	BMX DDI 1603	BMX DAI 1602	BMX DAI 1603 BMX DAI 1604
Page		2/16			
Compatibility with installation help system	TeSys® Quickfit®	-			
Compatibility with Modicon® Telefast® ABE 7 pre-wired system	Connection sub-bases	-			
	Input and output adaptor sub-bases	-			
Passive connection sub-base	Optimum "Economy"	-			
	Optimum "Miniature"	-			
	Universal	-			
Relay adaptor sub-base	Fixed relays	-			
	Plug-in relays	-			
Preformed cordsets with 40-way connector		-			
Pages		-			

32/64-channel high-density input modules
Connection via 40-way connectors with preformed cordsets



--- 24 V	
32 isolated channels	64 isolated channels
Via one 40-way connector	Via two 40-way connectors
Type 3	Non-IEC
Positive	
2-wire ---, 3-wire --- PNP any type	–
–	
–	
–	
–	
BMX DDI 3202K	BMX DDI 6402K

2/16

LU9 G02 splitter boxes (8 motor starters) and BMX FCC ●●1/●●3 preformed cordsets

Depending on model, 8- or 16-channel passive sub-bases, with or without LED, with common or 2 terminals per channel

Depending on model, 16-channel active sub-bases with solid state or electromechanical, fixed or removable relays, 5...48 V ---, 24 V ---, 24 V...240 V ~ or volt-free, with common or 2 terminals per channel, screw or spring-type connection

ABE 7H34●●0
ABE 7H16C●●
ABE 7H08R●●/7H08S21, ABE 7H16R1●/7H16R50, ABE 7H16R2●/7H16S21, ABE 7H16R3●/7H16R23, ABE 7H16S43,
ABE 7S16E2●●
ABE 7P16F31●●
BMX FCC ●●1/FCC ●●3
5/8 to 5/11, 2/17

16/32-channel mixed I/O modules
Connection via cage clamp, screw clamp or spring-type removable terminals **Connection via 40-way connectors with preformed cordsets**



--- 24 V I/O	--- and ~ (outputs only) 24 V inputs, relay outputs	--- 24 V I/O
8 isolated inputs and 8 isolated outputs		16 isolated inputs and 16 isolated outputs
Via BMX FTB 2000/2010/2020 20-way cage clamp, screw clamp or spring-type removable terminals		
Type 3		
Positive	–	Positive
Configurable output fallback, continuous monitoring of output control and resetting of outputs in case of detected internal fault		
Yes		
Protected	Not protected	Protected
Positive	–	Positive
BMX DDM 16022	BMX DDM 16025	BMX DDM 3202K

2/17

– LU9 G02 splitter boxes (8 motor starters) and BMX FCC ●●1/●●3 preformed cordsets

–	ABE 7H34●●0
–	ABE 7H16C●●
–	ABE 7H08R●●/7H08S21, ABE 7H16R1●/7H16R50, ABE 7H16R2●/7H16S21, ABE 7H16R3●/7H16R23, ABE 7H16S43/7H16F43
–	ABE 7S16E2●●
–	ABE 7S16S●●●/7R16S
–	ABE 7P16F31●●
–	ABE 7R16T●●●/7P16T●●●
–	BMX FCC ●●3
–	5/8 to 5/11, 2/17

Modicon® M340™ automation platform

Discrete I/O modules
Output modules

Applications

32/64-channel high-density output modules

Connection via 40-way connectors with preformed cordsets

2



Type	
Voltage	
Current	
Modularity (Number of channels)	
Connection	
Isolated outputs	Fallback
	IEC/EN 61131-2 conformity
	Protection
	Logic
Discrete output module	

--- solid state	
24 V	
0.1 A per channel	
32 protected channels	64 protected channels
Via one 40-way connector	Via two 40-way connectors
Configurable output fallback, continuous monitoring of output control and resetting of outputs in case of a detected internal fault	
Yes	
Current limiter with electronic tripping	
Positive	
BMX DDO 3202K	BMX DDO 6402K

Page	
Compatibility with installation help system	TeSys® Quickfit®
Compatibility with Modicon® Telefast® ABE 7 pre-wired system	Connection sub-bases
	Input adaptor sub-bases
Passive sub-base	Optimum "Economy"
	Optimum "Miniature"
	Universal
Relay adaptor sub-base	Fixed relays
	Removable relays
Preformed cordsets with 40-way connector	

2/16	
-	
-	
-	
ABE 7H34●●0	
ABE 7H16C●●	
ABE 7H08R●●/7H08S21, ABE 7H16R1●/7H16R50, ABE 7H16R2●/7H16S21, ABE 7H16R3● ABE 7H16F43	
ABE 7S16S●●● / 7R16S	
ABE 7R16T●●●/7P16T●●●	
BMX FCC●●1/FCC ●●3	

Pages	
--------------	--

5/8 to 5/11, 2/17	
-------------------	--

16-channel output modules

8/16-channel output modules

Connection via cage clamp, screw clamp or spring-type removable terminals



— solid state
24 V —
0.5 A per channel
16 protected channels

~ triac
100...240 V
0.6 A per channel
16 non-protected channels

—/~ relay
24 V —, 24...240 V ~
3 A (lth) per channel
2 A (lth) per channel
8 non-protected channels
16 non-protected channels

Via BMX FTB 2000/2010/2020 20-way cage clamp, screw clamp or spring-type removable terminals

Configurable output fallback, continuous monitoring of output control and resetting of outputs in case of a detected internal fault

Configurable output fallback

Yes

Yes

Current limiter with electronic tripping

-

Positive Negative

-



2/16

-
-
-
-
-
-
-
-
-
-
-
-
-
-
-
-
-
-
-
-
-
-
-
-
-
-
-
-

Introduction

Discrete I/O modules in the Modicon® M340® offer are standard modules occupying a single slot, equipped with either of the following:

- A connector for a screw or spring-type 20-way removable terminal block
- One or two 40-way connector(s)

A wide range of discrete inputs and outputs can be used to meet whatever requirements arise in terms of:

- functions, AC or DC I/O, positive or negative logic
- modularity, 8, 16, 32 or 64 channels per module

The inputs receive signals from the sensors and perform the following functions:

- acquisition
- adaptation
- electrical isolation
- filtering
- protection against interference signals

The outputs memorize commands issued by the processor to enable control of the preactuators via the decoupling and amplification circuits.

Description

BMX D●/D●O/DRA discrete I/O modules are standard format (1 slot). They have a case that helps to ensure IP 20 protection of the electronics, and are locked into position with a captive screw.

I/O modules connected via 20-way removable terminal block

- 1 Rigid body providing support and protection for the electronic card
- 2 Module reference marking (a label is also visible on the right-hand side of the module)
- 3 Channel status display block
- 4 Connector taking the 20-way removable terminal block for connecting sensors or preactuators

To be ordered separately:

- 5 A **BMX FTB 20●O** 20-way removable terminal block (label supplied with each I/O module) or a preformed cordset with a 20-way removable terminal block at one end and flying leads at the other (see page 2/7).

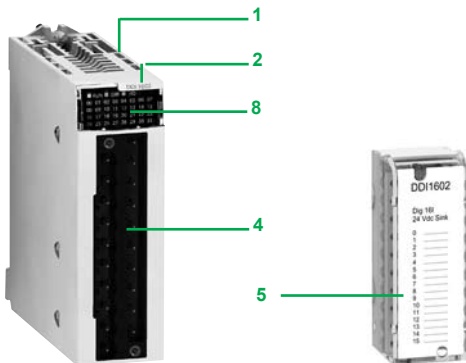

Module and 20-way removable terminal block

I/O modules connected via 40-way connector

- 1 Rigid body providing support and protection for the electronic card
- 2 Module reference marking (a label is also visible on the right-hand side of the module)
- 3 Channel status display block
- 4 One or two 40-way connectors (32 or 64 channels) (1) for connecting sensors or preactuators
- 5 With the 64-channel module, successive actuations of a pushbutton cause the display of the states of channels 0 ... 31 or 32 ... 64 on the block 3 (see page 2/9)

To be ordered separately, depending on the type of module:

One or two preformed cordset(s) with a 40-way connector (see page 2/7).

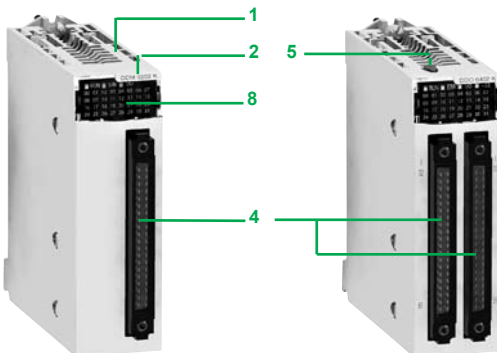

32- and 64-channel modules with for connection via 40-way connector(s)

(1) Fujitsu FCN 40-way connector

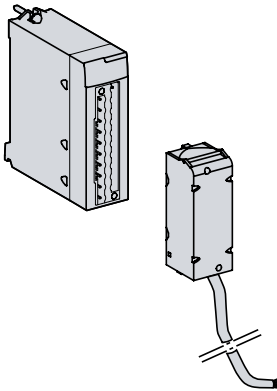

a Preformed cordset with removable terminal block at one end and flying leads at the other

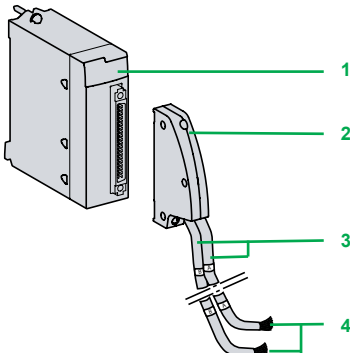

b Preformed cordset with 40-way connector at one end and 2 flying leads at the others

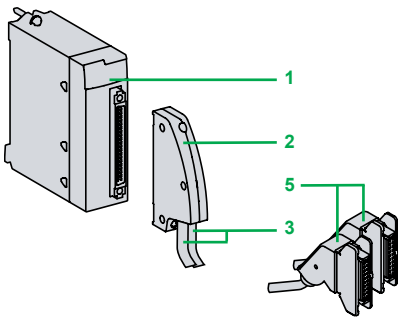

c Preformed cordset with 40-way connector and HE 10 connector for Modicon® Telefast® ABE 7 system

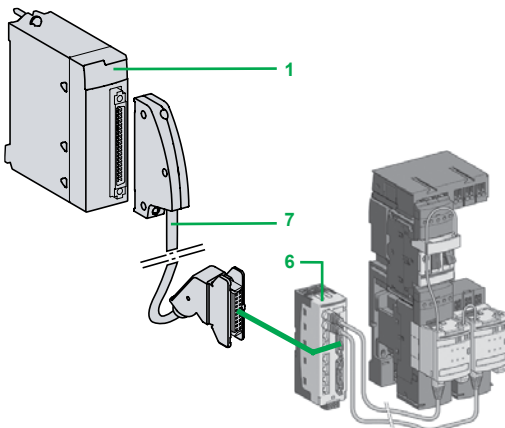

d Example of connection to the TeSys Quickfit installation help system

Connecting modules with removable terminal blocks

There are three types of 20-way removable terminal block:

- Screw clamp terminal block
- Cage clamp terminal block
- Spring-type terminal block

Each removable terminal block can take:

- Bare wires
- Wires equipped with DZ5-CE cable ends

a One version of the removable terminal block is equipped with **BMX FTW●●1** cordsets with color-coded flying leads (3, 5 or 10 m long).

Cage clamp terminal blocks

The capacity of each terminal is:

- Minimum: One 0.34 mm² wire (AWG 22)
- Maximum: One 1 mm² wire (AWG 18)

BMX FTB 2000 cage clamp connectors are equipped with captive screws (maximum tightening torque 0.5 N.m).

Screw clamp terminal blocks

The capacity of each terminal is:

- Minimum: One or two 0.34 mm² wires (AWG 22)
- Maximum: Two 1.5 mm² wires (AWG 15)

BMX FTB 2010 screw clamp connectors are equipped with captive screws (maximum tightening torque 0.5 N.m).

Spring-type terminal blocks

The capacity of each terminal in the **BMX FTB 2020** spring-type terminal blocks is:

- Minimum: One 0.34 mm² wire (AWG 22)
- Maximum: One 1 mm² wire (AWG 18)

Connecting modules with 40-way connectors

Preformed cordsets with 40-way connector at one end and flying leads at the other

b Preformed cordsets can be used for easy direct wire-to-wire connection between the I/O of modules with connectors **1** and the sensors, preactuators or intermediate terminals.

These preformed cordsets are comprised of:

- At one end, a 40-way connector **2** with either of the following:
 - One sheath containing 20 wires with a cross-section of 0.34 mm² (AWG 22) (**BMX FCW ●●1**)
 - Two sheaths **3**, each containing 20 wires with a cross-section of 0.34 mm² (AWG 22) (**BMX FCW ●●3**)
- At the other end **4**, color-coded flying leads conforming to standard DIN 47100 (see page 2/21)

Preformed cordsets with 40-way connector and HE 10 connector(s)

c Two types of cordset can be used for connecting the I/O of modules with 40-way connectors **1** to rapid wiring connection and adaptation interfaces called Modicon Telefast ABE 7 **2** (see page 5/6).

These preformed cordsets are comprised of:

- At one end, a 40-way connector **2** with either of the following:
 - One sheath **4** containing 20 wires (**BMX FCC ●●1**)
 - Two sheaths **5** each containing 20 wires (**BMX FCC ●●3**)
- At the other end, one or two HE 10 connectors **5**

Connection to TeSys Quickfit system

d **BMX DDI 3202K/6402K** input modules, **BMX DDO 3202K/6402K** output modules or **BMX DDM 3202K** mixed input/output module **1** are designed for use with TeSys® Quickfit® installation help systems via **LU9 G02** splitter module **6** (for 8 motors starters).

The modules are easily connected using **BMX FCC ●●1/●●3** preformed cordsets **7**.

Functions

Hot swapping

Due to their integrated devices, I/O modules (including application-specific modules) can be removed and connected while powered up.

Note: When the PLC is powered up and running, the I/O modules can be removed without any material risk by performing the following sequence **before** removing the module:

- Disconnect the power voltage on the outputs
- Disconnect the sensor and preactuator power supply
- Remove the terminal block or connector

I/O module assignment

Discrete I/O modules have different parameters for each channel. The channels are grouped into blocks of 4, 8 or 16 consecutive channels depending on the type of module. Each group of channels can be assigned to a specific application task (master or fast).

Protection of DC inputs

The 24 and 48 V $\overline{\text{DC}}$ inputs are constant-current type. This characteristic makes it possible to:

- Help ensure minimum current in active state in compliance with the IEC standard
- Limit the current consumption when the input voltage increases to avoid unwanted temperature rise in the module
- Reduce the current consumption on the sensor power supply provided by the PLC power supply or by a process power supply

Protection of DC outputs

Protected solid state outputs have a protective device. When an output is active, the protective device can detect the occurrence of the following:

- An overload or short-circuit: This deactivates the output (tripping) and indicates a detected fault on the display on the module front panel (the LED for the affected channel flashes, the I/O module detected fault LED lights up).
- Reverse polarity: This will short-circuit the power supply without damaging the module. For this protection to work in optimum conditions, it is essential to place a fast-blow fuse on the power supply upstream of the preactuators.
- Inductive overvoltage: Each output is protected individually against inductive overvoltages and has a fast zener diode demagnetization circuit for electromagnets that can reduce the output response time for some fast machines.

Reactivation of DC outputs

If a detected fault has caused an output to trip, the output can be reactivated using this parameter if no other terminal detected fault is present.

Reactivation is defined for each group of 8 channels. It has no effect on an inactive channel or one that is OK.

The reactivation command can be:

- Programmed: Reactivation is carried out by a command from the PLC application or via the debug screen. To avoid repeated reactivations too close together, the module automatically allows a time delay of 10 s between two reactivations.
- Automatic: Reactivation takes place automatically every 10 s until the detected fault disappears.

RUN/STOP command

An input can be configured to control the RUN/STOP mode for the PLC.

This is taken into account on a rising edge. A STOP command from an input has priority over a RUN command from a programming terminal or via the network.

Functions (continued)

Output fallback

This parameter defines the fallback mode used by the DC solid state outputs when the PLC stops following a:

- Processor detected fault
- Detected rack fault
- Detected fault on the cable connecting the racks

The outputs must be set to a state that is not harmful to the application. This state, known as the fallback position, is defined for each module when the DC solid state outputs are configured. This configuration offers a choice between:

- Fallback: The channels are set to 0 or 1 according to the fallback value defined for the group of 8 corresponding channels.
- Maintain: The outputs maintain the state they were in before the stop occurred.

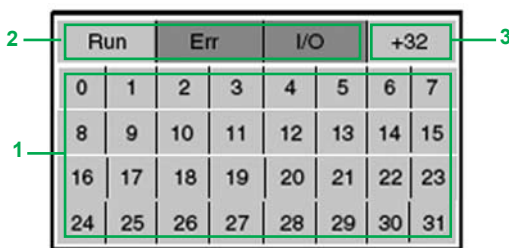

I/O module diagnostics

Each discrete I/O module is equipped with a display block on the front panel centralizing all the information necessary for module control, diagnostics and maintenance. The display block comprises:

- 1 A set of 8, 16 or 32 green LEDs depending on the module modularity. Each LED is associated with one channel:
 - On: channel in state 1; Off: channel in state 0
 - Flashing: channel inoperative, overloaded or short-circuited
- 2 Three LEDs indicating the module status:
 - RUN (green): On: Normal operation
 - ERR (red): On: Detected internal module fault; Flashing: Detected communication fault between the module and the processor
 - I/O (red): On: External detected fault (sensor/preactuator voltage, overload, short-circuit, etc.); Flashing: Detected terminal block fault
- 3 A +32 LED (green) indicating, in the case of 64-channel modules, whether the set of 32 LEDs 1 displays the state of channels 0...31 (off) or the state of channels 32...63 (on). This +32 LED is activated or deactivated by a pushbutton located on top of the module.

Diagnostics via Unity Pro

Using the integrated diagnostics in Unity Pro, this local diagnostics on the module's front panel is complemented by system diagnostics based on predefined screens at global hardware configuration level, module level and channel level (see pages 4/23 and 4/24).

Remote diagnostics using a web browser on a "Thin Client" PC

In addition, the diagnostics described above can be performed remotely using a simple web browser thanks to the standard web server integrated in the Modicon® M340® platform (processor with integrated Ethernet port or Ethernet module), using the "ready-to-use" Rack Viewer function (see page 3/4).

Compatibility with 2-wire and 3-wire sensors							
Input type	24 V $\overline{\text{---}}$ Non-IEC positive log. (sink)	48 V $\overline{\text{---}}$ type 1 positive log. (sink)	24 V $\overline{\text{---}}$ type 3 positive log. (sink)	24 V \sim type 1	48 V \sim type 3	100...120 V \sim type 3	
Any 3-wire $\overline{\text{---}}$ sensor, PNP type							
Any 3-wire $\overline{\text{---}}$ sensor, NPN type				(1)			
Schneider Electric 2-wire $\overline{\text{---}}$ sensor or other brand, with the following specifications: - Residual voltage in closed state ≤ 7 V - Minimum switched current ≤ 2.5 mA - Residual current in open state ≤ 1.5 mA							
Schneider Electric 2-wire $\overline{\text{---}}$ sensor or other brand with the following specifications: - Residual voltage in closed state ≤ 4 V - Minimum switched current ≤ 1 mA - Residual current in open state ≤ 0.5 mA							
2-wire $\overline{\text{---}}/\sim$ sensor (1)							
2-wire \sim sensor							

Compatible
 Compatible with restriction
 Not compatible

For combinations with Osiprox® inductive proximity sensors, see pages 6/10 and 6/11.
For combinations with Osiris® photo-electric sensors, see page 6/12.

(1) 24 V \sim sensors can be used as negative logic (source) 24 V $\overline{\text{---}}$ inputs compatible with 3-wire $\overline{\text{---}}$ sensor NPN type, but in this case, are not IEC-compliant.

Common specifications

Environment

Temperature derating The specifications at 60°C are validated for 60% of inputs and 60% of outputs at state 1.

Specifications of DC input modules

Module			BMX DDI 1602	BMX DDI 1603	BMX DDI 3202K	BMX DDI 6402K	BMX DAI 1602	
Number of inputs			16		32	64	16	
Commons	Number		1		2	4	1	
Connection			Spring or screw-type 20-way removable terminal block		One 40-way connector	Two 40-way connectors	Spring or screw-type 20-way removable terminal block	
Nominal input values	Voltage	V	24 ---	48 ---	24 ---			
	Current	mA	3.5	2.5	2.5	1	3	
	Logic		Positive (<i>sink</i>)				Negative (<i>source</i>)	
Input limit values	At state 1	Voltage	V	≥ 11	≥ 34	≥ 11	≥ 15	≥ 14
		Current	mA	> 2 (for U ≥ 11 V)	> 2 (for U ≥ 34 V)	> 2 (for U ≥ 11 V)	> 1 (for U ≥ 15 V)	> 2
	At state 0	Voltage	V	< 5	< 10	< 5		
		Current	mA	≤ 1.5	≤ 0.5	≤ 1.5	≤ 0.5	
	Sensor power supply (ripple included)		V	19...30 (possible up to 34 V, limited to 1 hour in every 24 hours)	38...60	19...30 (possible up to 34 V, limited to 1 hour in every 24 hours)		
	Input impedance at nominal voltage			kΩ	6.8	19.2	9.6	24
Response time (filtering)	Typical	ms	4					10
	Maximum	ms	7					20
Reverse polarity			Protected			No	–	
IEC/EN 61131-2 conformity			Type 3	Type 1	Type 3	Non-IEC		
Compatibility with 2-wire/3-wire sensors			IEC/EN 60947-5-2				–	
Paralleling of inputs (1)			Yes		No			
Protection of inputs			Use one 0.5 A fast-blow fuse per group of channels					
Insulation resistance			MΩ	> 10 at 500 V ---				
Dielectric strength	Primary/Secondary	V rms	1,500 - 50/60 Hz for 1 minute (up to 4,000 m)					
	Between groups of channels	V	–		500 ---		–	
Type of input			Current sink				Resistive	
Sensor voltage control threshold	OK	V	> 18 ---	> 36 ---	> 18 ---			
	Out of range	V	< 14 ---	< 24 ---	< 14 ---			
Consumption	Typical	mA	See Power consumption table on page 6/13					
Maximum dissipated power			W	2.5	3.6	3.9	4.3	3
Temperature derating			None					

(1) This characteristic allows several inputs to be wired in parallel on the same module or on different modules for input redundancy.

Specifications of AC input modules						
Module			BMX DAI 1602	BMX DAI 1603	BMX DAI 1604	
Number of inputs			16			
Commons	Number		1			
Connection			Spring or screw-type 20-way removable terminal block			
Nominal input values	Voltage	V	24 ~	48 ~	100...120 ~	
	Current	mA	3	5		
	Frequency	Hz	50/60			
Input limit values	At state 1	Voltage	V	≥ 15	≥ 34	≥ 74
		Current	mA	≥ 2		≥ 2.5
	At state 0	Voltage	V	≤ 5		≤ 10
		Current	mA	≤ 1		≤ 20
	Frequency		Hz	47...63		
	Sensor power supply (ripple included)		V	20...26	40...52	85...132
Current peak on activation	At nominal voltage	mA	5	95	240	
Input impedance at nominal voltage and F = 55 Hz		kΩ	6	9	13	
Response time (filtering)	Activation	ms	15	10		
	Deactivation	ms	20			
IEC/EN 61131-2 conformity			Type 1	Type 3		
Compatibility with 2-wire/3-wire sensors			IEC/EN 60947-5-2			
Protection of inputs			Use one 0.5 A fast-blow fuse per group of channels			
Insulation resistance		MΩ	>10 at 500 V ---			
Dielectric strength		V rms	1,500 - 50/60 Hz for 1 minute (up to 4,000 m)			
Type of input			Resistive	Capacitive		
Sensor voltage control threshold	OK	V	> 18	> 36	> 82	
	Out of range	V	< 14	< 24	< 40	
Reliability	MTBF in hours	At T _{ambient} = 30°C	1,504,958			
Consumption	Typical	mA	See Power consumption table on page 6/13			
Maximum dissipated power		W	3	4	3.8	
Temperature derating			None			

Specifications of triac output module			
Module			BMX DAO 1605
Number of outputs			16
Commons	Number		4
Connection			Spring or screw-type 20-way removable terminal block
Operating voltages	Nominal	V	100...240 ~
	Limit	V	85...288 ~
Currents	Maximum	A	0.6 per channel, 2.4 per common, 4.8 total for 4 commons
	Minimum		25 mA at 100 V ~, 25 mA at 240 V ~
Maximum inrush current		A	≤ 20/cycle
Leakage current	At state 0	mA	≤ 1.5 for 120 V ~, 60 Hz, ≤ 3 for 240 V ~, 60 Hz
Residual voltage	At state 1	V	≤ 1.5
Response time	Activation	ms	≤ 1 +/- 0.5 Hz
Nominal resistive load	Deactivation	ms	≤ 1 +/- 0.5 Hz
Type of command			Passage through zero
Built-in protection			Varistor
Protection fuses			None (use an external fast-blow fuse)
Dielectric strength		V rms	2,830 ~/3 cycles (up to 2,000 m)
Insulation resistance		MΩ	> 10 at 500 V ---
Consumption	Typical	mA	See Power consumption table on page 6/13
Maximum dissipated power			–

2

Specifications of DC solid state output modules						
Module			BMX DDO 1602	BMX DDO 1612	BMX DDO 3202K	BMX DDO 6402K
Number of inputs			16		32	64
Commons	Number		1		2	4
Connection			Spring or screw-type 20-way removable terminal block		One 40-way connector	Two 40-way connectors
Output nominal values	Voltage	V	24 ...			
	Current	A	0.5		0.1	
	Logic		Positive (source)	Negative (sink)	Positive (source)	
Output limit values	Voltage (ripple included)	V	19...30 (possible up to 34 V, limited to 1 hour in every 24 hours)			
	Current per channel	A	0.625		0.125	
	Current per module	A	10		3.2	6.4 if $\theta \leq 40^\circ\text{C}$ 5.1 if $\theta \leq 50^\circ\text{C}$ 3.8 if $\theta \leq 60^\circ\text{C}$
Tungsten filament lamp power		W	6 maximum		1.2 maximum	
Leakage current	At state 0	mA	< 0.5		0.1 (for U = 30 V)	
Residual voltage	At state 1	V	< 1.2		< 1.5 (for I = 0.1 A)	
Minimum load impedance		Ω	48		220	
Response time (1)		ms	1.2			
Maximum overload time		ms	-		15	
Compatibility with IEC/EN 61131-2 DC inputs			Yes	-	Yes	
Paralleling of outputs			Yes (2 max.)	Yes (3 max.)		
Switching frequency on inductive load		Hz	0.5/LI ²			
Built-in protection	Against overvoltages		Yes, by Transil diode			
	Against inversions		Yes, by reverse-mounted diode. Use a 2 A fuse on the + 24 V of the preactuators.			
	Against short-circuit and overloads		Yes, with current limiter and electronic circuit-breaker 1.5 In < Id < 2 In		Yes, with current limiter and electronic circuit-breaker 0.125 A < Id < 0.185 A	
Preactuator voltage control threshold	At state 0	V	> 18			
	Out of range	V	< 14			
Insulation resistance		MΩ	> 10 at 500 V ...			
Dielectric strength	Output/ground or output/internal logic	V rms	1,500 ~ - 50/60 Hz for 1 minute			
	Between groups of channels	V	-		500 ...	
Consumption	Typical	mA	See Power consumption table on page 6/13			
Maximum dissipated power		W	4	2.26	3.6	6.85
Temperature derating			None			See "Current per module" above

(1) Outputs are equipped with a fast demagnetization circuit for the electromagnets. Discharge time for the electromagnets < L/R.

Specifications of relay output modules													
Module				BMX DRA 0805				BMX DRA 1605					
Number of inputs				8				16					
Commons		Number		Without common point				2					
Connection				Spring or screw-type 20-way removable terminal block									
Limit operating voltages		DC	V	10...34 ---				24...125 --- (resistive load)					
		AC	V	19...264 ~				200...264 ~ (Cos φ = 1)					
Thermal current			A	3				2					
Switching load		Minimum	mA	1 at 5 V ---									
Electrical life				-				24 V	100 V	200 V	240 V		
AC load		Power	VA	-				-					
		cos φ = 0.7		-				300 (1), 80 (2)					
DC load		Power	W	-				-					
		cos φ = 0.35		-				200 (1), 60 (2)					
Voltage				24 V	48 V	110...120 V	200...240 V	24 V	100 V	200 V	240 V		
AC load		Resistive loads AC-12	Power	VA	50 (3)	50 (4), 110 (5)	110 (4), 220 (5)	220 (4)	-				
		Inductive loads AC-15 (cos φ = 0.3)	Power	VA	24 (5)	10 (6), 24 (7)	10 (8), 50 (9), 110 (10)	10 (8), 50 (11), 110 (4), 220 (12)	-		200 (1), 60 (2)	120 (1), 36 (2)	
		Inductive loads AC-14 (cos φ = 0.7)	Power	VA	-				-		300 (1), 80 (2)	240 (1), 72 (2)	
DC load		Resistive loads DC-12	Power	W	24 (4), 40 (13)	-				-			
		Inductive loads DC-13 (14)	Power	W	10 (7), 24 (4)	-		24 (1), 7.2 (2)	10 (1), 3 (2)	-			
Response time		Activation	ms	< 10									
		Deactivation	ms	< 8				< 12					
Built-in protection		Against overloads and short-circuits		None. Use a fast-blow fuse per channel or group of channels									
		Against AC inductive overvoltages		None. Use an RC circuit or ZNO surge limiter appropriate to the voltage in parallel on each output									
		Against DC inductive overvoltages		None. Use a discharge diode on each output									
Insulation resistance			MΩ	> 10 at 500 V ---									
Dielectric strength			V rms	2,000 - 50/60 Hz for 1 minute									
Consumption		Typical	mA	See Power consumption table on page 6/13									
Dissipated power			W	2.7 max.				3					
Temperature derating				None									

(1) For 1 x 10⁵ operating cycles
 (2) For 3 x 10⁵ operating cycles
 (3) For 0.7 x 10⁶ operating cycles
 (4) For 1 x 10⁶ operating cycles
 (5) For 0.5 x 10⁶ operating cycles
 (6) For 5 x 10⁶ operating cycles
 (7) For 2 x 10⁶ operating cycles
 (8) For 10 x 10⁶ operating cycles
 (9) For 1.5 x 10⁶ operating cycles
 (10) For 0.15 x 10⁶ operating cycles
 (11) For 3 x 10⁶ operating cycles
 (12) For 0.1 x 10⁶ operating cycles
 (13) For 0.3 x 10⁶ operating cycles
 (14) Where L/R = 60 ms for BMX DRA 0805 module, L/R = 7 ms for BMX DRA 1605 module

Specifications of mixed I/O relay module					
Module			BMX DDM 16025		
			24 V $\overline{\text{---}}$ inputs	24 V $\overline{\text{---}}$ or 24...240 V \sim relay outputs	
Number of inputs/outputs			8	8	
Commons	Number		1	1	
Connection			Spring or screw-type 20-way removable terminal block		
Nominal values	Inputs	Voltage	V	24 $\overline{\text{---}}$ (positive logic)	
		Current	mA	3.5	
	Outputs	DC voltage	V	24 $\overline{\text{---}}$	
		Direct current	A	2 (resistive load)	
		AC voltage	V	220 \sim , Cos φ = 1	
		Alternating current	A	2	
Input limit values	At state 1	Voltage	V	≥ 11	
		Current	mA	≥ 2 (for $U \geq 11$ V)	
	At state 0	Voltage	V	5	
		Current	mA	≤ 1.5	
	Sensor power supply (ripple included)		V	19...30 (possible up to 30 V, limited to 1 hour in every 24 hours)	
Input impedance at nominal voltage			kΩ	6.8	
Input response time	Typical		ms	4	
	Maximum		ms	7	
Reverse polarity on inputs			Protected		
IEC/EN 61131-2 conformity			Yes, type 3		
Compatibility with 2-wire/3-wire sensors			IEC/EN 60947-5-2		
Paralleling of inputs			No		
Input type			Current sink		
Output response time	Activation		ms	≤ 12	
	Deactivation		ms	≤ 10	
Switching load	Minimum			5 V $\overline{\text{---}}$ /1 mA	
	Maximum		V	264 \sim /125 $\overline{\text{---}}$	
Mechanical durability	No. of switching operations			≥ 20 million	
Fuse protection			Use one 0.5 A fast-blow fuse per group of channels		No (use one fast-blow fuse per channel or group of channels)
Sensor voltage control thresholds	OK		V	> 18	
	Out of range		V	< 14	
Relay output			Voltage	24 V	200 V
AC load	Inductive loads AC-14 (cos φ = 0.7)	Power	VA	–	300 (1), 80 (2)
		Power	VA	–	200 (1), 60 (2)
DC load	Inductive loads DC-13	Power	W	–	24 (1), 7.2 (2)
					–
Maximum switching frequency				3,600 cycles/hour	
Insulation resistance			MΩ	> 10 at 500 V $\overline{\text{---}}$	
Dielectric strength	Primary/secondary		V rms	1,500 - 50/60 Hz for 1 minute	
	Between groups of I/O		V	500 $\overline{\text{---}}$	
	Max. voltage		V rms	–	
Consumption	Typical		mA	See Power consumption table on page 6/13	
Dissipated power			W	3.1 maximum	
Temperature derating				None	

(1) For 1×10^5 operating cycles
 (2) For 3×10^5 operating cycles

Specifications of 24 V ~ mixed I/O modules							
Module			BMX DDM 16022		BMX DDM 3202K		
			Inputs	Solid state outputs	Inputs	Solid state outputs	
Number of inputs/outputs			8	8	16	16	
Commons	Number		1	1	1	1	
Connection			Spring or screw-type 20-way removable terminal block		One 40-way connector		
Nominal values			24 ~				
Voltage			V				
Current			mA	3.5	500	2.5	
Logic				Positive (sink)	Positive (source)	Positive (sink)	
Tungsten filament lamp power			W	–	6 maximum	–	
Input limit values	At state 1	Voltage	V	≥ 11	–	≥ 11	
		Current	mA	> 3 (for U ≥ 11 V)	–	≥ 2 (for U ≥ 11 V)	
	At state 0	Voltage	V	5	–	5	
		Current	mA	≤ 1.5	–	≤ 1.5	
	Sensor power supply (ripple included)		Possible up to 30 V, limited to 1 hour in every 24 hours	V	19...30	–	19...30
	Output limit values	Voltage (ripple included)	Possible up to 30 V, limited to 1 hour in every 24 hours	V	–	19...30	–
Currents		Per channel	A	–	0,625	–	
		Per module	A	–	5	–	
Input impedance at nominal voltage			kΩ	6.8	–	9.6	
Input response time	Typical		ms	4	–	4	
	Maximum		ms	7	–	7	
Reverse polarity on inputs				Protected	–	Protected	
IEC/EN 61131-2 conformity				Yes, type 3	–	Yes, type 3	
Compatibility with 2-wire/3-wire sensors				IEC/EN 60947-5-2	–	IEC/EN 60947-5-2	
Input type				Current sink	–	Current sink	
Leakage current	At state 0		mA	–	< 0.5	–	
Residual voltage	At state 1		V	–	< 1.2	–	
Minimum load impedance			Ω	–	48	–	
Output response time (1)			ms	–	1.2	–	
Max. overload time before detected fault state			ms	–	15	–	
Compatibility with IEC 61131-2 DC inputs				–	Yes	–	
Paralleling of outputs				–	Yes (2 maximum)	–	
Switching frequency on inductive load			Hz	–	0.5/LI ²	–	
Built-in protection	Against overvoltages			–	Yes, by Transil diode	–	
	Against inversions			–	Yes, by reverse-mounted diode. Use a 2 A fuse on the preactuator + 24 V	–	
	Against short-circuits and overloads			Use one 0.5 A fast-blow fuse per group of channels	Yes, by current limiter and electronic circuit-breaker 1.5 In < Id < 2 In	Use one 0.5 A fast-blow fuse per group of channels	
Sensor and preactuator voltage control thresholds	OK		V	> 18			
	Out of range			< 14			
Insulation resistance			MΩ	> 10 at 500 V ~			
Dielectric strength	Primary/secondary		V rms	1,500 - 50/60 Hz for 1 minute			
	Between groups of inputs and outputs		V	500 ~			
	Outputs/ground or outputs/internal logic			–	1,500 - 50/60 Hz for 1 minute	–	
Consumption	3.3 V ~	Typical	mA	79		125	
		Maximum	mA	111		166	
	24 V ~ preactuators (2)	Typical	mA	59		69	
		Maximum	mA	67		104	
Maximum dissipated power			W	3.7		4	
Temperature derating				None			

(1) Outputs are equipped with a fast demagnetization circuit for the electromagnets. Discharge time for the electromagnets < L/R.
 (2) Excluding load current.

Modicon® M340™ automation platform

Discrete I/O modules

2



BMX DDI 160



BMX DDI 3202K



BMX DDI 6402K

References						
Discrete input modules						
Type of current	Input voltage	Connection by (1)	IEC/EN 61131-2 conformity	No. of channels (common)	Reference	Weight kg
⎓	24 V (positive logic)	Screw or spring-type 20-way removable terminal block	Type 3	16 isolated inputs (1 x 16)	BMX DDI 1602	0.115
		One 40-way connector	Type 3	32 isolated inputs (2 x 16)	BMX DDI 3202K	0.112
		Two 40-way connectors	Non-IEC	64 isolated inputs (4 x 16)	BMX DDI 6402K	0.145
~	24 V (negative logic)	Screw or spring-type 20-way removable terminal block	Non-IEC	16 isolated inputs (1 x 16)	BMX DAI 1602	0.115
		Screw or spring-type 20-way removable terminal block	Type 1	16 isolated inputs (1 x 16)	BMX DDI 1603	0.115
		Screw or spring-type 20-way removable terminal block	Type 3	16 isolated inputs (1 x 16)	BMX DAI 1602	0.115
~	48 V (positive logic)	Screw or spring-type 20-way removable terminal block	Type 1	16 isolated inputs (1 x 16)	BMX DDI 1603	0.115
		Screw or spring-type 20-way removable terminal block	Type 3	16 isolated inputs (1 x 16)	BMX DAI 1603	0.115
		Screw or spring-type 20-way removable terminal block	Type 3	16 isolated inputs (1 x 16)	BMX DAI 1604	0.115



BMX DDO 1602



BMX DRA 0805/1605



BMX DDO 3202K



BMX DDO 6402K

Discrete output modules						
Type of current	Output voltage	Connection by (1)	IEC/EN 61131-2 conformity	No. of channels (common)	Reference	Weight kg
⎓ solid state	24 V/0.5 A (positive logic)	Screw or spring-type 20-way removable terminal block	Yes	16 protected outputs (1 x 16)	BMX DDO 1602	0.120
		Screw or spring-type 20-way removable terminal block	Non-IEC	16 protected outputs (1 x 16)	BMX DDO 1612	0.120
	24 V/0.1 A (positive logic)	One 40-way connector	Yes	32 protected outputs (2 x 16)	BMX DDO 3202K	0.110
		Two 40-way connectors	Yes	64 protected outputs (4 x 16)	BMX DDO 6402K	0.150
~ triac	100...240	Screw or spring-type 20-way removable terminal block	–	16 outputs (4 x 4)	BMX DAO 1605	0.140
⎓ or ~ relay	12...24 V ⎓/3 A, 24...240 V ~/3 A	Screw or spring-type 20-way removable terminal block	Yes	8 non-protected outputs (without common)	BMX DRA 0805	0.145
		Screw or spring-type 20-way removable terminal block	Yes	16 non-protected outputs (2 x 8)	BMX DRA 1605	0.150

(1) By connector module supplied with cover(s).

Modicon® M340™ automation platform

Discrete I/O modules

BMX
DDM 16022BMX
DDM 3202K

References (continued)

Discrete mixed I/O modules

Number of I/O	Connection via (1)	No. of inputs (common)	No. of outputs (common)	IEC/EN 61131-2 Reference conformity	Reference	Weight kg
16	Screw or spring-type 20-way removable terminal block	8 (positive logic) (1 x 8)	8, solid state 24 V $\overline{\text{---}}$ / 0,5 A (1 x 8)	Inputs, type 3	BMX DDM 16022	0.115
			8, relay 24 V $\overline{\text{---}}$ or 24...240 V \sim (1 x 8)	Inputs, type 3	BMX DDM 16025	0.135
32	One 40-way connector	16 (positive logic) (1 x 16)	16, solid state 24 V $\overline{\text{---}}$ / 0,1 A (1 x 16)	Inputs, type 3	BMX DDM 3202K	0.110

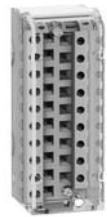

BMX FTB 2000

Removable connection blocks

Description	Use	Type	Reference	Weight kg
20-way removable terminal blocks	For module with 20-way removable terminal block	Cage clamp	BMX FTB 2000	0.093
		Screw clamp	BMX FTB 2010	0.075
		Spring-type	BMX FTB 2020	0.060



BMX FTW 01

Preformed cordsets for I/O modules with removable terminal block

Description	Composition	Length	Reference	Weight kg
Preformed cordsets with one end with flying leads	One 20-way removable terminal block (BMX FTB 2020) One end with color-coded flying leads	3 m	BMX FTW 301	0.850
		5 m	BMX FTW 501	1.400
		10 m	BMX FTW 1001	2.780



BMX FCW 01

Preformed cordsets for I/O modules with 40-way connectors

Description	No. of sheaths	Composition	Cross-section	Length	Reference	Weight kg
Preformed cordsets with one end with flying leads	1 x 20	One 40-way connector wires (16 channels) One end with color-coded flying leads	0.324 mm ²	3 m	BMX FCW 301	0.820
				5 m	BMX FCW 501	1.370
				10 m	BMX FCW 1001	2.770
	2 x 20	One 40-way connector wires (32 channels) Two ends with color-coded flying leads	0.324 mm ²	3 m	BMX FCW 303	0.900
				5 m	BMX FCW 503	1.490
				10 m	BMX FCW 1003	2.960



BMX FCW 03

Preformed cordsets for Modicon Telefast ABE 7 sub-bases

	1 x 20	One 40-way connector wires (16 channels) One HE 10 connector	0.324 mm ²	0.5 m	BMX FCC 051	0.140
				1 m	BMX FCC 101	0.195
				2 m	BMX FCC 201	0.560
				3 m	BMX FCC 301	0.840
				5 m	BMX FCC 501	1.390
				10 m	BMX FCC 1001	2.780
	2 x 20	One 40-way connector wires (32 channels) Two HE 10 connectors	0.324 mm ²	0.5 m	BMX FCC 053	0.210
				1 m	BMX FCC 103	0.350
				2 m	BMX FCC 203	0.630
				3 m	BMX FCC 303	0.940
				5 m	BMX FCC 503	1.530
				10 m	BMX FCC 1003	3.000



BMX FCC 01

2

Input modules

BMX DDI 1602

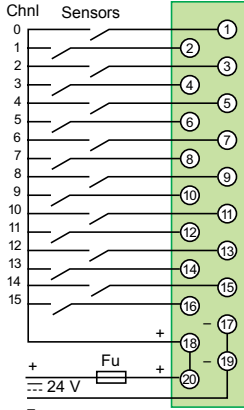

BMX DDI 3202K/6402K

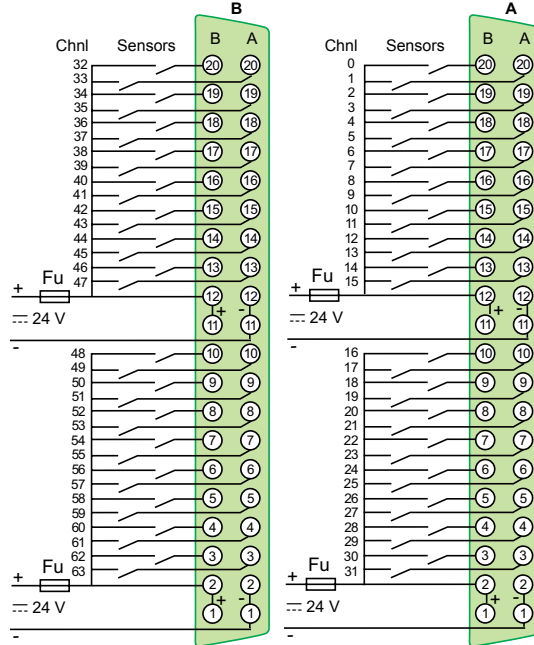

BMX DDI 1603

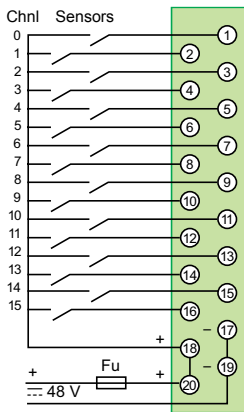

BMX DDI 3202K: Connector A (inputs I0...I31)

BMX DDI 6402K: Connector A (inputs I0...I31) and connector B (inputs I32...I63)

For correspondence of the 40-way connector pins with the wire colors of **BMX FCW ●01/●03** prewired cordsets, in accordance with DIN 47100, see table on page 2/21.

BMX DAI 1602/1603/1604

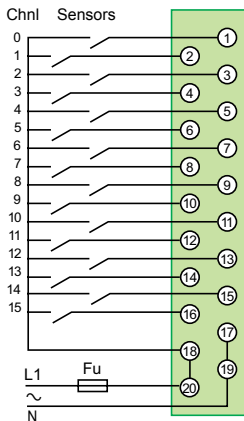

BMX DAI 1602, use in 24 V ~, negative logic

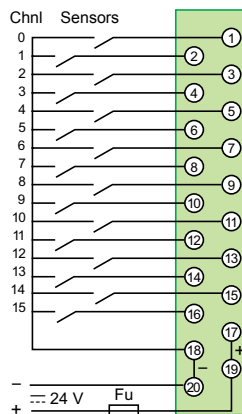

L1-N voltage: 24 V ~, **BMX DAI 1602**
48 V ~, **BMX DAI 1603**
100/120 V ~, **BMX DAI 1604**
Fu: 0.5 A fast-blow fuse

Output modules

BMX DDO 1602

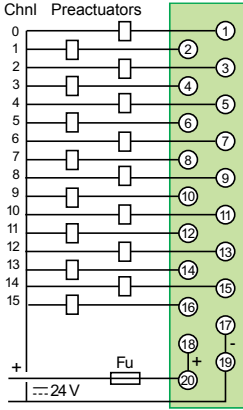

BMX DDO 1612

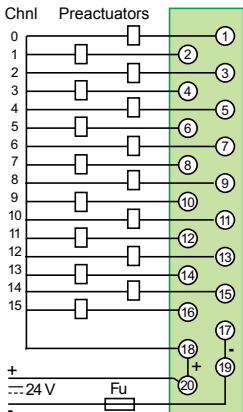

BMX DDO 3202K/6402K

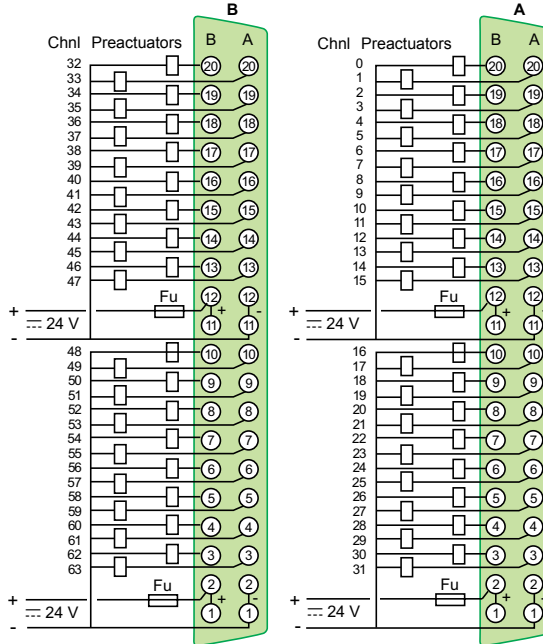

BMX DDO 3202K: Connector A (outputs I0...I31)

BMX DDO 6402K: Connector A (outputs I0...I31) and connector B (inputs I32...I63)

For correspondence of the 40-way connector pins with the wire colors of **BMX FCW ●01/●03** prewired cordsets, in accordance with DIN 47100, see table on page 2/21.

BMX DAO 1605

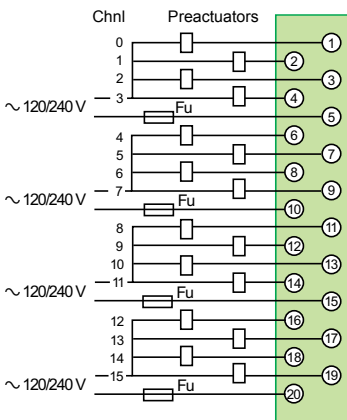

BMX DRA 0805

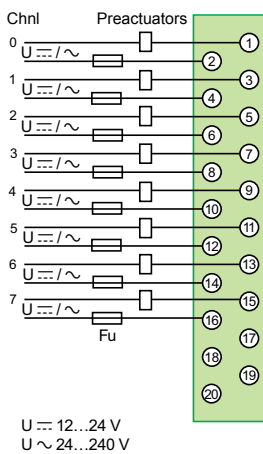

BMX DRA 1605

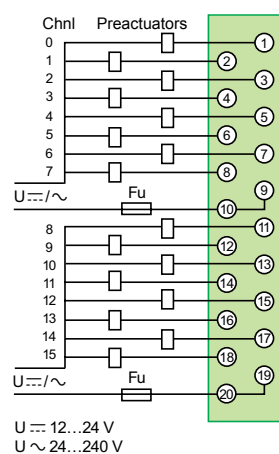

Mixed I/O modules

BMX DDM 16025

BMX DDM 16022

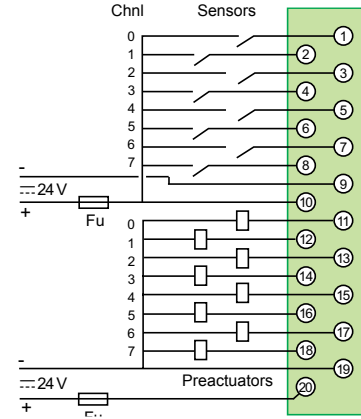
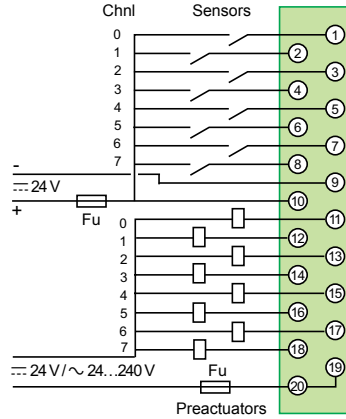

BMX DDM 3202K

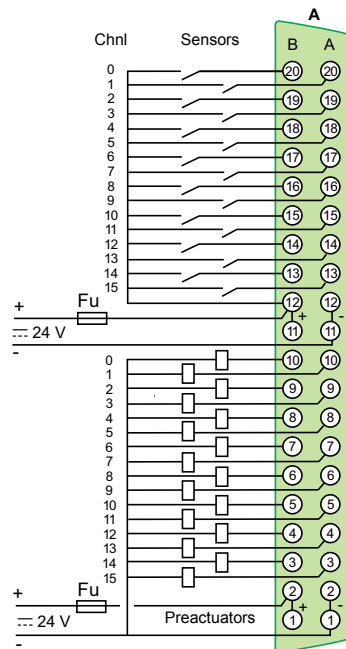

Fu: 0.5 A fast-blow fuse

Connection cables with 40-way connector and end(s) with flying leads BMX FCW ●01/●03

Correspondence of connector pins with the wire colors at the sheath end

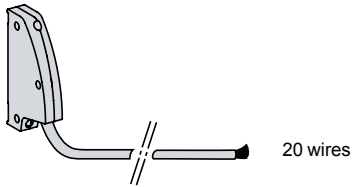

Cordset with one sheathed end with flying leads
BMX FCW ●01

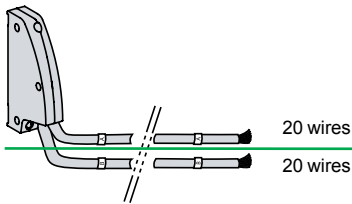

Cordset with two sheathed ends with flying lead
BMX FCW ●03

Connector pin no.	Color at sheath end	32/64-channel inputs	32/64-channel outputs	32-channel I/O
B20	White	Input 0/32	Output 0/32	Input 0
A20	Brown	Input 1/33	Output 1/33	Input 1
B19	Green	Input 2/34	Output 2/34	Input 2
A19	Yellow	Input 3/35	Output 3/35	Input 3
B18	Gray	Input 4/36	Output 4/36	Input 4
A18	Pink	Input 5/37	Output 5/37	Input 5
B17	Blue	Input 6/38	Output 6/38	Input 6
A17	Red	Input 7/39	Output 7/39	Input 7
B16	Black	Input 8/40	Output 8/40	Input 8
A16	Purple	Input 9/41	Output 9/41	Input 9
B15	Gray/pink	Input 10/42	Output 10/42	Input 10
A15	Red/blue	Input 11/43	Output 11/43	Input 11
B14	White/green	Input 12/44	Output 12/44	Input 12
A14	Brown/green	Input 13/45	Output 13/45	Input 13
B13	White/yellow	Input 14/46	Output 14/46	Input 14
A13	Yellow/brown	Input 15/47	Output 15/47	Input 15
B12	White/gray	+ 24 V	+ 24 V	+ 24 V
A12	Gray/brown	- 24 V	- 24 V	- 24 V
B11	White/pink	+ 24 V	+ 24 V	+ 24 V
A11	Pink/brown	- 24 V	- 24 V	- 24 V
B10	White	Input 16/48	Output 16/48	Output 0
A10	Brown	Input 17/49	Output 17/49	Output 1
B9	Green	Input 18/50	Output 18/50	Output 2
A9	Yellow	Input 19/51	Output 19/51	Output 3
B8	Gray	Input 20/52	Output 20/52	Output 4
A8	Pink	Input 21/53	Output 21/53	Output 5
B7	Blue	Input 22/54	Output 22/54	Output 6
A7	Red	Input 23/55	Output 23/55	Output 7
B6	Black	Input 24/56	Output 24/56	Output 8
A6	Purple	Input 25/57	Output 25/57	Output 9
B5	Gray/pink	Input 26/58	Output 26/58	Output 10
A5	Red/blue	Input 27/59	Output 27/59	Output 11
B4	White/green	Input 28/60	Output 28/60	Output 12
A4	Brown/green	Input 29/61	Output 29/61	Output 13
B3	White/yellow	Input 30/62	Output 30/62	Output 14
A3	Yellow/brown	Input 31/63	Output 31/63	Output 15
B2	White/gray	+ 24 V	+ 24 V	+ 24 V
A2	Gray/brown	- 24 V	- 24 V	- 24 V
B1	White/pink	+ 24 V	+ 24 V	+ 24 V
A1	Pink/brown	- 24 V	- 24 V	- 24 V

Note: Each input not used must be connected to 0 V in --- or neutral in ~ (Immunity to electromagnetic fields EMC).

Connection cables with 20-way terminal block at one end and flying leads at the other BMX FTW ●01

Correspondence of 20-way removable terminal block pins with the wire colors (at sheath end)

Correspondence of terminal block pins with the wire colors at the sheath end

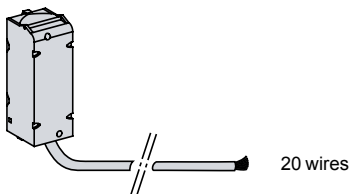

Cordset with 1 sheathed end with flying lead
BMX FTW ●01

Terminal block pin no.	Color at sheath end	16-channel inputs	8- or 16-channel outputs	16-channel I/O
1	White	Input 0	See page 2/19	Input 0
2	Brown	Input 1	See page 2/19	Input 1
3	Green	Input 2	See page 2/19	Input 2
4	Yellow	Input 3	See page 2/19	Input 3
5	Gray	Input 4	See page 2/19	Input 4
6	Pink	Input 5	See page 2/19	Input 5
7	Blue	Input 6	See page 2/19	Input 6
8	Red	Input 7/	See page 2/19	Input 7
9	Black	Input 8	See page 2/19	Sensor + common power supply
10	Purple	Input 9	See page 2/19	Sensor pwr supply
11	Gray/pink	Input 10	See page 2/19	Output 0
12	Red/blue	Input 11	See page 2/19	Output 1
13	White/green	Input 12	See page 2/19	Output 2
14	Brown/green	Input 13	See page 2/19	Output 3
15	White/yellow	Input 14	See page 2/19	Output 4
16	Yellow/brown	Input 15	See page 2/19	Output 5
17	White/gray	Power supply	See page 2/19	Output 6
18	Gray/brown	+ common pwr sup.	See page 2/19	Output 7
19	White/pink	Power supply	See page 2/19	Preactuator pwr sup.
20	Pink/brown	Power supply	See page 2/19	Preactuator pwr sup.

Applications

Analog inputs



Type of I/O	
Type	
Range	Voltage
	Current
	Thermocouple, Temperature probe, Resistor
Modularity	
Acquisition period	
Conversion time	
Resolution	
Isolation	
Connection	Directly to the module
	Via preformed cordsets
Module	

Isolated low-level voltage inputs, resistors, thermocouples and temperature probes	
Multi-range	
± 40 mV, ± 80 mV, ± 160 mV, ± 320 mV, ± 640 mV and ± 1.28 V	
–	
Thermocouples type B, E, J, K, L, N, R, S, T, U Temperature probes type Pt 100, Pt 1000, Ni 100, Ni 1000 and Cu 10, 2-, 3- or 4-wire Resistors 2-, 3- or 4-wire, 400 Ω or 4,000 Ω	
4 channels	8 channels
400 ms for 4 channels	400 ms for 8 channels
–	
16 bits	
Between channels: 750 V --- Between channels and bus: 1,400 V --- Between channels and ground: 750 V ---	
Via 40-way connector	Via two 40-way connectors
BMX FCW ●01S cordsets with one end with color-coded flying leads (3 or 5 m long)	
BMX ART 0414	BMX ART 0814

Page

2/31



Compatibility with Modicon® Telefast® ABE 7 pre-wired system	
Type of module	Connection sub-base
	Preformed cordsets (length 1.5, 3 or 5 m)

Sub-base with 4 channels for direct connection of 4 thermocouples plus connection and provision of cold-junction compensation	
ABE 7CPA412	
BMX FCA●●2	

Pages

5/11 and 2/31

Analog inputs



Analog outputs



Mixed analog I/O



Isolated high-level inputs
Voltage/current
± 10 V, 0...10 V, 0...5 V, 1...5 V, ± 5 V
0...20 mA, 4...20 mA, ± 20 mA
–
4 channels
Fast: 1 + (1 x no. of declared channels) ms By default, 5 ms for 4 channels
–
16 bits
Between channels: 300 V $\overline{\text{---}}$ Between channels and bus: 1,400 V $\overline{\text{---}}$ Between channels and ground: 1,400 V $\overline{\text{---}}$

Isolated high-level outputs
Voltage/current
± 10 V
0...20 mA, 4...20 mA
–
2 channels
–
≤ 1 ms
16 bits
Between channels: 750 V $\overline{\text{---}}$ Between channels and bus: 1,400 V $\overline{\text{---}}$ Between channels and ground: 1,400 V $\overline{\text{---}}$

Non-isolated high-level inputs	Non-isolated high-level outputs
Voltage/current	
± 10 V, 0...10 V, 0...5 V, 1...5 V	± 10 V
0...20 mA, 4...20 mA	0...20 mA, 4...20 mA
–	–
4 channels	2 channels
Fast: 1 + (1 x no. of declared channels) ms By default, 5 ms for 4 channels	–
–	≤ 1 ms
14...12 bits in U range 12 bits in I range	12 bits in U range 11 bits in I range
Between group of input channels and group of output channels: 750 V $\overline{\text{---}}$ Between channels and bus: 1,400 V $\overline{\text{---}}$ Between channels and ground: 1,400 V $\overline{\text{---}}$	

Via 20-way removable terminals (screw or spring-type)
 BMX FTW ●01S cordsets with one end with color-coded flying leads (3 or 5 m long)

BMX AMI 0410

BMX AMO 0210

BMX AMM 0600

2/31



4-channel sub-base for direct connection of 4 inputs, delivers and distributes 4 protected isolated power supplies

4-channel sub-base (only 2-channel used) for direct connection of 2 outputs

ABE 7CPA410

ABE 7CPA21

BMX FCA●●0

BMX FCA●●0

5/11 and 2/31

Introduction

The analog I/O module offer consists of:

- Three isolated analog input modules:
 - 4 analog high-speed channels (16 bits), voltage or current, **BMX AMI 0410**
 - 4 and 8 analog channels (15 bits + sign) for thermocouples, Pt, Ni or Cu temperature probes, **BMX ART 0414/0814**
- One analog output module with 2 voltage/current channels, **BMX AMO 0210**
- One mixed module (12 bits) with 4 analog input channels and 2 analog output channels, non-isolated, voltage or current, **BMX AMM 0600**

Analog I/O modules are equipped with a connector for a 20-way removable terminal block, except for **BMX ART 0414/0814** analog input modules with thermocouples/temperature probes that are equipped with a 40-way connector.

All analog modules occupy a single slot in the **BMX XBP ●●●** racks. These modules can be installed in any slot in the rack, except for the first two (PS and 00) which are reserved for the power supply module in the **BMX CPS ●●0** rack and the **BMX P34 ●●0** processor module respectively.

The power supply for the analog functions is supplied by the backplane bus (3.3 V and 24 V). Analog I/O modules are hot-swappable (see page 2/8).

In a Modicon M340 single-rack configuration, the maximum number of analog channels is limited by the number of slots available in the rack (11 slots maximum).

Description

BMX AM●/ART analog I/O modules are standard format (1 slot). They have a case that helps to ensure IP 20 protection of the electronics, and are locked into position by a captive screw.

I/O modules connected via 20-way removable terminal block

- 1 Rigid body providing support and protection for the electronic card
- 2 Module reference marking (a label is also visible on the right-hand side of the module)
- 3 Channel status display block
- 4 Connector taking the 20-way removable terminal block for connecting sensors or preactuators

To be ordered separately:

- 5 A **BMX FTB 20●0** 20-way removable terminal block (label supplied with each I/O module) or a preformed cordset with a 20-way removable terminal block at one end and flying leads at the other (see page 2/30).

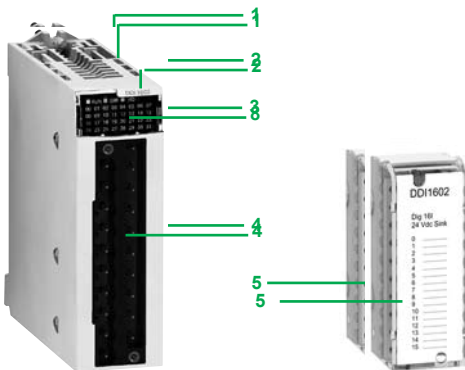

Module and 20-way removable terminal block

I/O modules connected via 40-way connector

- 1 Rigid body providing support and protection for the electronic card
- 2 Module reference marking (a label is also visible on the right-hand side of the module)
- 3 Channel status display block
- 4 One or two 40-way connectors (32 or 64 channels) (1) for connecting sensors or preactuators
- 5 With the 64-channel module, successive actuations of a pushbutton cause the display of the states of channels 0 ... 31 or 32 ... 64 on the block 3 (see page 2/31)

To be ordered separately, depending on the type of module:

One or two preformed cordset(s) with a 40-way connector (see page 2/30).

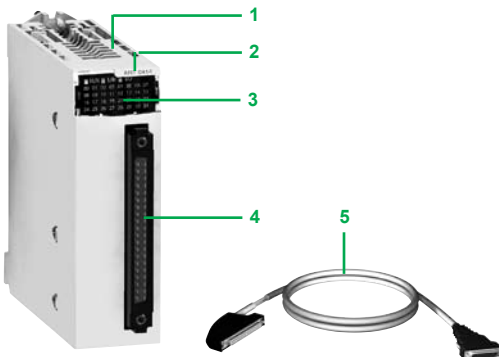

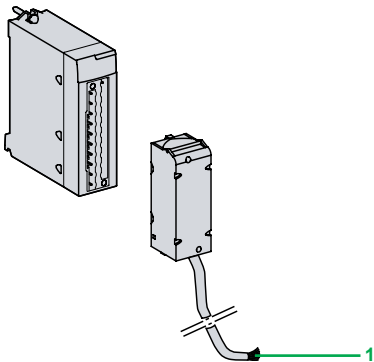

BMX FTW 01S cordset
(with 20-way removable terminal block at one end and flying leads at the other)

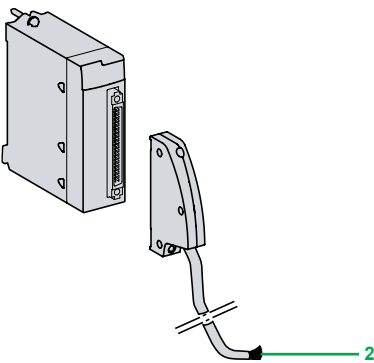

BMX FCW 01S cordset
(with 40-way connector at one end and flying leads at the other)

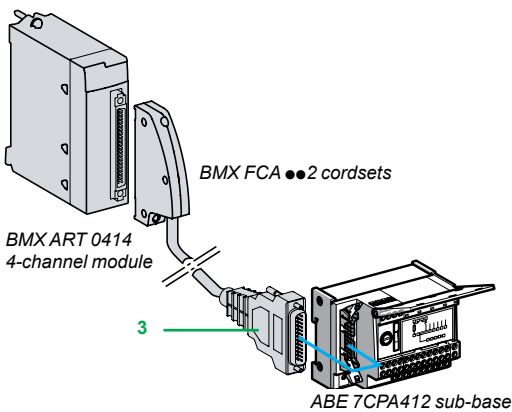

Connecting modules with removable terminal blocks

BMX AMI 0410/AMO 0210/AMM 0600 modules with 20-way terminal block

These 20-way removable terminal blocks are the same as those used for discrete I/O modules (screw clamp, cage clamp or spring-type). See page 2/7.

One version of the removable terminal block is equipped with a 3 or 5 m long cordset with color-coded flying leads (**BMX FTW 01S**). These preformed cordsets, with reinforced shielding have, at the other end **1**, color-coded flying leads.

Connecting modules with 40-way connectors

BMX ART 0014 modules with 40-way connectors

Two types of cordset are available:

- Preformed cordsets with reinforced shielding (**BMX FCW 01S**) have color-coded flying leads **2**. They are available in 3 or 5 m lengths, and provide easy direct wire-to-wire connection of the analog sensors via terminal blocks.
- Preformed cordsets with reinforced shielding (**BMX FCA 002**) that also have a 25-way SUB-D connector **3**. They are available in 1.5, 3 or 5 m lengths, and provide direct connection to the Modicon® Telefast® **ABE 7CPA412** sub-base (see below).

Use with Modicon Telefast ABE 7 sub-bases

Using the Modicon Telefast ABE 7 pre-wired system makes it easier to install the modules since the inputs (or outputs) can be accessed using screw terminals. Two special sub-bases are available:

Modicon Telefast ABE 7CPA410 sub-base

The Modicon Telefast **ABE 7CPA410** sub-base is mainly used in conjunction with the **BMX AMI 0410** voltage/current analog 4-input module. It is used to:

- Connect the four sensors directly
- Remotely locate the input terminals in voltage mode
- Power the 4...20 mA conditioners one channel at a time with a 24 V voltage, protected and limited to 25 mA, while maintaining isolation between channels
- Protect the current impedance matching resistors integrated in the sub-base against overvoltages

Connection is via the **BMX FCA 000** cordset (1.5, 3 or 5 m long).

Modicon Telefast ABE 7CPA412 sub-base

The Modicon Telefast **ABE 7CPA412** sub-base is specially designed as a wiring interface for the **BMX ART 0414** and **BMX ART 0814** thermocouple modules. It is used to:

- Connect the four thermocouple probes
- Provide external cold-junction compensation with a temperature probe integrated in the sub-base
- Help ensure continuity of the shielding

The **BMX ART 0814** module requires two Modicon Telefast **ABE 7CPA412** sub-bases. The connection with each sub-base is made via a **BMX FCA 002** cordset **3** (1.5, 3 or 5 m long).

Modicon Telefast ABE 7CPA21 sub-base

The Modicon Telefast **ABE 7CPA21** sub-base is compatible with the **BMX AMO** and **BMX ART 0210** voltage/current analog 2-output module. It is used to:

- Connect the two channels
- Help ensure continuity of the shielding

Connection is via the **BMX FCA 000** cordset (1.5, 3 or 5 m long).

BMX AMI 0410 analog input modules

The **BMX AMI 0410** module is a high-level analog input module with 4 isolated inputs (16 bits).

Used with sensors or transmitters, it performs monitoring, measurement and process control functions for continuous processes.

For each input, the **BMX AMI 0410** module offers the following ranges:

- Voltage $\pm 10\text{ V}$, $\pm 5\text{ V}$, $0\dots 10\text{ V}$, $0\dots 5\text{ V}$ and $1\dots 5\text{ V}$
- Current $0\dots 20\text{ mA}$, $4\dots 20\text{ mA}$ and $\pm 20\text{ mA}$, depending on the choice made during configuration

The module operates with voltage inputs. It includes four reading resistors connected to the terminal block to form the current inputs.

Functions

The **BMX AMI 0410** module includes the following functions:

- Adaptation and multiplexing:
 - Physical connection to the process
 - Protection of the module against overvoltages
 - Protection of the current reading resistors
 - Adaptation of input signals by analog filtering
 - Scanning of input channels by solid state multiplexing, by optical commutator switches
- Adaptation to input signals: Gain selection, drift compensation
- Conversion: 24-bit analog/digital converter
- Conversion of input measurements to a unit that is suitable for the user:
 - Taking account of the alignment coefficients to be applied to measurements, as well as the module autocalibration coefficients
 - Measurement filtering, depending on the configuration parameters
 - Measurement scaling, depending on the configuration parameters
- Interface and communication with the application:
 - Receipt of the configuration parameters for the module and its channels
 - Transmission of measured values to the application, as well as module status
- Module power supply
- Module monitoring and indication of any detected faults to the application:
 - Conversion circuit test
 - Channel range overshoot test and watchdog test.

BMX ART 0414/0814 analog input modules

BMX ART 0414/0814 modules are multirange input modules with 4 or 8 low-level isolated inputs (15 bits + sign) respectively.

Depending on the choice made during configuration, the modules offer for each of the inputs the following range:

- Temperature probe: Pt100, Pt1000, Cu10, Ni100 or Ni1000, with open-circuit detection
- Thermocouple: B, E, J, K, L, N, R, S, T or U, with broken wire detection
- Resistor: $0\dots 400$ or $0\dots 4000\ \Omega$, 2-, 3- or 4-wire
- Voltage: $\pm 40\text{ mV}$, $\pm 80\text{ mV}$, $\pm 160\text{ mV}$, $\pm 320\text{ mV}$, $\pm 640\text{ mV}$, $\pm 1.28\text{ V}$.

Functions

BMX ART 0414/0814 modules offer the following functions

- Adaptation and current source per channel:
 - Accepting an overload of $\pm 7.5\text{ V}$
 - Autocalibration of the analog module offset as close as possible to the input terminal
 - Selection of the cold-junction compensation sensor included in the Modicon® Telefast® **ABE 7CPA412** sub-base or externally by the Pt 100 probe
- Adaptation to input signals: Based on a low offset amplifier internal to the A/D converter
- Conversion: 16-bit converter
- Conversion of input measurements to a unit that is suitable for the user:
 - Taking account of the alignment coefficients to be applied to measurements, as well as the module autocalibration coefficients
 - Measurement filtering, depending on the configuration parameters
 - Measurement scaling, depending on the configuration parameters
- Interface and communication with the application:
 - Receipt of the configuration parameters for the module and its channels
 - Transmission of measured values to the application, as well as module status
- Module monitoring and indication of any detected faults to the application:
 - Conversion circuit test
 - Channel range overshoot test and watchdog test.

BMX AMO 0210 analog output module

The **BMX AMO 0210** module is a module with 2 high-level isolated outputs (15 bits + sign). It offers, for each of them, the ranges:

- Voltage: ± 10 V
- Current: 0...20 mA and 4...20 mA

The range is selected during configuration.

Functions

The **BMX AMO 210** module includes the following functions:

- Physical connection to the process
- Protection of the module against overvoltages
- Adaptation of the output signals:
 - Voltage or current adaptation by software configuration
 - Protection of the outputs against short-circuits and overloads
- Conversion to 15 bits with sign with redefinition of data
- Conversion of application values into data that can be used by the digital/analog converter:
 - Use of factory calibration parameters
- Interface and communication with the application:
 - Managing exchanges with the processor
 - Geographical addressing
 - Receipt of the configuration parameters for the module and its channels
 - Transmission of module status to the application
- Module monitoring and indication of any detected faults to the application:
 - Output power supply test
 - Channel range overshoot test
 - Detected output fault test
 - Watchdog test.

BMX AMM 0600 mixed analog I/O module

The **BMX AMM 0600** mixed module is a module with 4 inputs 14/12 bits and 2 outputs 12 bits non-isolated between one another. It offers, for each of them, the ranges:

- Voltage: ± 10 V, 0...10 V, 0...5 V and 1...5 V
- Current: 0...20 mA and 4...20 mA.

Functions

The **BMX AMM 0600** module has the following functions:

- Protection of the module against overvoltages
- Adaptation to the different actuators: voltage or current output
- Conversion of digital signals (11 bits or 12 bits depending on the range) to analog signals
- Conversion of application data into data that can be used by the digital/analog converter
- Module monitoring and detected fault indication to the application: Converter test, range overshoot test, watchdog test.

Specifications of BMX AMI 0410 analog input modules

Input module		BMX AMI 0410	
Input type		Isolated high-level inputs	
Number of channels		4	
Nature of inputs	Voltage	± 10 V, 0...10 V, 0...5 V, 1...5 V, ± 5 V	
	Current	0...20 mA, 4...20 mA, ± 20 mA (via protected internal 250 Ω resistors)	
Analog/digital conversion		Σ Δ 24 bits	
Voltage/current range		± 10 V	± 5 V 0...5 V 0...10 V 1...5 V 0...20 mA 4...20 mA ± 20 mA
Maximum conversion value		± 11.4 V ± 30 mA	
Resolution		0.35 mV 0.92 μA	
Input impedance	Typical	MΩ	10 (regardless of the input level)
Permitted overload on the inputs	Voltage range	V	± 30 ---
	Current range	mA	± 90 of short-circuit to + 24 V ---
Voltage/current internal conversion resistor		Ω	250
Precision of internal conversion resistor		0.1% - 15 ppm/°C	
Filtering		1 st order digital filtering	
Read cycle time	Fast	ms	1 + 1 x no. of channels used (periodic reading of no. of declared channels)
	Default	ms	5 for 4 channels (periodic reading of each channel)
Measurement tolerance (1)	At 25°C	%FS	0.075% 0.15% (2)
	Maximum at 0...60°C	%FS	0.1% 0.3% (2)
Temperature drift		15 ppm/°C 30 ppm/°C	
Recalibration		Internal	
Common mode between channels		dB	120
Digital value format		± 10,000 by default, ± 32,000 in user scale	
Isolation	Between channels	V	± 300 ---
	Between channels and bus	V	1,400 ---
	Between channels and ground	V	1,400 ---
Consumption	Typical	mA	See Power consumption table on page 6/13

Specifications of BMX ART 0414/0814 analog input modules

Input module		BMX ART 0414		BMX ART 0814	
Input type		Isolated inputs, low-level voltage, resistors, temperature probes, thermocouples			
Number of channels		4		8	
Nature of inputs		± 40 mV; ± 80 mV; ± 160 mV; ± 320 mV; ± 640 mV; ± 1.28 V			
Analog/digital conversion		Σ Δ 16 bits			
Resolution		mV	15 + sign		
Filtering		1 st order digital filtering			
Read cycle time			ms	400 with temperature probes (1...4)	400 with temperature probes (1...8)
				200 with thermocouples (1...4)	200 with thermocouples (1...8)
Permitted overload on the inputs		V ± 7.5 ---			
50/60 Hz rejection	Differential mode	Typical	dB	60	
	Common mode	Typical	dB	120	
Cold junction compensation	External compensation by Pt100 probe using		- the dedicated Modicon® Telefast® ABE 7CPA412 sub-base including the probe - a Pt 100 temperature probe 2-wire on channel 0 and/or 4 (thermocouple channel maintained) - a Pt 100 temperature probe 3-wired on channel 0 and/or 4 (thermocouple channel non maintained)		
Recalibration		Internal			
Isolation	Between channels	V	750 ---		
	Between channels and bus	V	1,400 ---		
	Between channels and ground	V	750 ---		
Consumption	Typical	mA	See Power consumption table on page 6/13		

(1) %FS: Tolerance as a% of full scale

Specifications of BMX ART 0414/0814 analog input modules

Input ranges for BMX ART 0414/0814 modules

Voltage range			± 40 mV	± 80 mV	± 160 mV	± 320 mV	± 640 mV	± 1.28 V
Typical input impedance		MΩ	10					
Maximum conversion value			± 102.5%					
Maximum resolution		mV	40/2 ¹⁴	80/2 ¹⁴	160/2 ¹⁴	320/2 ¹⁴	640/2 ¹⁴	1280/2 ¹⁴
Measurement tolerance (1)	At 25°C	%FS	0.05					
	Maximum at 0...60°C	%FS	0.15					
Temperature drift		ppm/°C	30					
Resistor range			400 Ω			4,000 Ω		
Type			2-, 3- or 4-wire					
Maximum conversion value			± 100%					
Maximum resolution		mV	400/2 ¹⁴			4,000/2 ¹⁴		
Measurement tolerance (1)	At 25°C	%FS	0.12					
	Maximum at 0...60°C	%FS	0.2					
Temperature drift		ppm/°C	25					
Temperature probe ranges			Pt100	Pt1000	Cu10	Ni100	Ni1000	
Measurement range		°C	According to IEC: -200...+850 According to US/JIS: -100...+450		-100...+260	-60...+180		
Resolution		°C	0.1					
Detection type			Open circuit (detection on each channel)					
Measurement tolerance (1)	At 25°C (2)	°C	± 2.1		± 4	± 2.1	0.7	
	Maximum at 0...60°C	°C	± 2		± 4	± 3.0	1.3	
Max. wiring resistance	4-wire	Ω	50	500	50	500		
	2/3-wire	Ω	20	200	20	200		
Temperature drift			30 ppm/°C					
Thermocouple ranges			B	E	J	K	L	
Measurement range		°C	+130...+1820	-270...+1000	-200...+760	-270...+1370	-200...+900	
Resolution		°C	0.1					
Detection type			Open circuit (detection on each channel)					
Measurement tolerance (1)	At 25°C	°C	± 3.5	± 3.7	± 2.8	± 3.7	± 3.0	
	Maximum at 0...60°C	°C	± 5	± 5	± 4.5	± 5	± 4.5	
Temperature drift		ppm/°C	25					
Thermocouple ranges (continued)			N	R	S	T	U	
Measurement range		°C	+270...+1300	-50...+1769	-50...+1769	-270...+400	-200...+600	
Resolution		°C	0.1					
Detection type			Open circuit (detection on each channel)					
Measurement tolerance (1)	At 25°C	°C	± 3.7	± 3.2	± 3.2	± 3.7	± 2.7	
	Maximum at 0...60°C	°C	± 5	± 4.5	± 4.5	± 5	± 4.5	
Temperature drift		ppm/°C	25					

(1) %FS: Tolerance as a% of full scale. ± 1°C with Pt100 temperature probe range, - 100...+ 200°C

Specifications of the BMX AMO 0210 analog output module

Module		BMX AMO 0210		
Output type		Isolated high-level outputs		
Number of channels		2		
Ranges	Voltage	± 10 V		
	Current	0...20 mA and 4...20 mA		
Resolution	bits	15 + sign		
Conversion time	ms	≤ 1		
Output power supply		Internal power supply via rack		
Output ranges		Voltage	Current	
Adjustment range	Nominal	V	± 10 V	0...20 mA, 4...20 mA
	Maximum	V	± 11.25 V	24 mA
Load impedance	Ω	≥ 1,000	≤ 600	
Detection type		Short-circuit	Open circuit	
Measurement tolerance (1)	At 25°C	%FS	0.10	
	Maximum at 0...60°C	%FS	0.25	
Temperature drift		40 ppm/°C		
Recalibration		None, factory-calibrated		
Fallback mode (2)		Default or configurable		
Isolation	Between channels	V	750 ---	
	Between channels and bus	V	1,400 ---	
	Between channels and ground	V	1,400 ---	
Consumption	Typical	mA	See Power consumption table on page 6/13	

Specifications of BMX AMM 0600 mixed analog I/O module

Module		BMX AMM 0600								
Channel type		Non-isolated high-level inputs					Non-isolated high-level outputs			
Number of channels		4					2			
Ranges		± 10 V	0...5 V	0...10 V	1...5 V	0...20 mA	4...20 mA	± 10 V	0...20 mA	4...20 mA
	Maximum conversion value	Voltage	V				± 11.25	–	± 11.25	–
	Current	mA				–	0...30	–	0...24 mA	
Resolution		bits		14	12	13	12	12	11	
Filtering		1 st order digital filtering by firmware								
Precision of internal conversion resistor		250 Ω, 0.2% - 25 ppm/°C								
Read cycle time	Fast	ms		1 + 1 x no. of channels used (periodic reading of no. of declared channels)					–	
	Default	ms		5 for 4 channels					–	
Conversion time		ms		≤ 1					≤ 2	
Permitted overload on the input channels	Voltage	V				± 30	–	± 11.25	–	
	Current	mA				–	± 30	–	0...24	
Measurement tolerance (1)	At 25°C	%FS		0.25	0.35		0.25	0.25		
	Maximum at 0...60°C	%FS		0.35	0.50		0.60	0.60		
Temperature drift		30 ppm/°C				50 ppm/°C		100 ppm/°C		
Recalibration		Internal					None, factory-calibrated			
Fallback mode (2)		–					Default or configurable			
Isolation	Between group of input channels and group of output channels	V	750 ---							
	Between channels and bus	V	1,400 ---							
	Between channels and ground	V	1,400 ---							
Consumption	Typical	mA	See Power consumption table on page 6/13							

(1) %FS: Error as a% of full scale

(2) Default: Output at 0 (V or mA). Configurable: Hold last value or set at predefined value for each channel.

Modicon® M340™ automation platform

Analog I/O modules



BMX AM 0000



BMX ART 0414



BMX FTB 2000



BMX FTW 01S



ABE 7CPA412/ ABE 7CPA21



BMX FCA 001



BMX FCA 002

References

Analog input modules

Input type	Input signal range	Resolution	Connection	No. of channels	Reference	Weight kg
Isolated high-level inputs	± 10 V, 0...10 V, 0...5 V, 1...5 V, ± 5 V 0...20 mA, 4...20 mA	16 bits	Via cage clamp, screw clamp or spring-type removable terminal block	4 fast channels	BMX AMI 0410	0.143
Isolated low-level inputs	Temperature probe, thermocouple ± 40 mV, ± 80 mV, ± 160 mV, ± 320 mV, ± 640 mV, ± 1.28 V 0...400 Ω, 0...4000 Ω	15 bits + sign	40-way connector	4 channels 8 channels	BMX ART 0414 BMX ART 0814	0.135 0.165

Analog output module

Output type	Output signal range	Resolution	Connection	No. of channels	Reference	Weight kg
Isolated high-level outputs	± 10 V, 0...20 mA, 4...20 mA	16 bits	Via cage clamp, screw clamp or spring-type removable terminal block	2 channels	BMX AMO 0210	0.144

Mixed analog I/O module

Channel type	Signal range	Resolution	Connection	No. of channels	Reference	Weight kg
Mixed I/O, non-isolated	± 10 V, 0...10 V, 0...5 V, 1...5 V, 0...20 mA, 4...20 mA	14 bits or 12 bits depending on the range	Via cage clamp, screw clamp or spring-type removable terminal block	I: 4 channels Q: 2 channels	BMX AMM 0600	0.155

Connection accessories for analog modules (1)

Description	For use with modules	Type, composition	Length	Reference	Weight kg
20-way removable terminal blocks	BMX AMI 0410	Cage clamp	–	BMX FTB 2000	0.093
	BMX AMO 0210	Screw clamp	–	BMX FTB 2010	0.075
	BMX AMM 0600	Spring-type	–	BMX FTB 2020	0.060
Preformed cordsets	BMX AMI 0410	One 20-way removable terminal block (BMX FTB 2020)	3 m	BMX FTW 301S	0.470
	BMX AMO 0210		5 m	BMX FTW 501S	0.700
	BMX ART 0414	One 40-way connector	3 m	BMX FCW 301S	0.480
	BMX ART 0814 (2)		5 m	BMX FCW 501S	0.710

Modicon® Telefast® ABE 7 pre-wired system

Modicon Telefast ABE 7 sub-bases	For use with modules	Type, composition	Length	Reference	Weight kg
BMX AMI 0410	BMX AMI 0410	Distribution of isolated power supplies Delivers 4 protected isolated power supplies for 4...20 mA inputs Direct connection of 4 inputs	–	ABE 7CPA410	0.180
BMX ART 0414 BMX ART 0814	BMX ART 0414 BMX ART 0814	Connection and provision of cold junction compensation for thermocouples Direct connection of 4 inputs	–	ABE 7CPA412	0.180
BMX AMO 0210	BMX AMO 0210	Direct connection of 2 outputs (2-channels of sub-bases are not used)	–	ABE 7CPA21	0.210
Preformed cordsets for ABE 7CPA sub-bases	BMX AMI 0410	One 20-way removable terminal block and one 25-way SUB-D connector for ABE 7CPA410/21 sub-base	1.5 m	BMX FCA150	0.320
	BMX AMO 0210		3 m	BMX FCA300	0.500
			5 m	BMX FCA500	0.730
	BMX ART 0414 BMX ART 0814	One 40-way connector and one 25-way SUB-D connector for ABE 7CPA412 sub-base	1.5 m 3 m 5 m	BMX FCA152 BMX FCA302 BMX FCA502	0.330 0.510 0.740

(1) The shielding on the cordsets carrying the analog signals must always be connected to the **BMX XSP000** shielding connection kit mounted under the rack holding the analog modules. See page 1/15.

(2) The **BMX ART 0814** 8-channel module requires two **ABE 7CPA412** sub-bases and two **BMX FCA002** cordsets.

Analog input/output modules

BMX AMI 0410/AMO 0210/AMM 0600

BMX ART 0414 (A) and BMX ART 0814 (A and B)

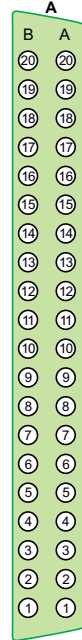
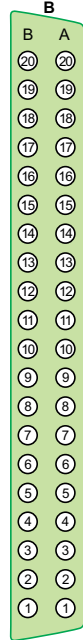
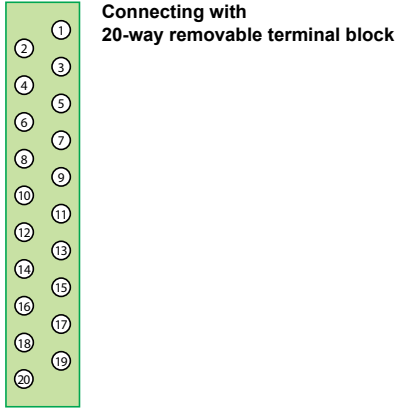

Connecting via one or two 40-way connector(s)

Correspondence of terminal block with the wire colors at the sheath end **BMX FTW 301S/501S** preformed cordsets. See table on page 2/33.

Correspondence of connector(s) 40-pin with the wire colors at the sheath end of **BMX FCW 301S/501S** preformed cordsets. See table on page 2/33.

Connecting example of 2, 3 or 4-wire temperature probes with cold-junction compensation

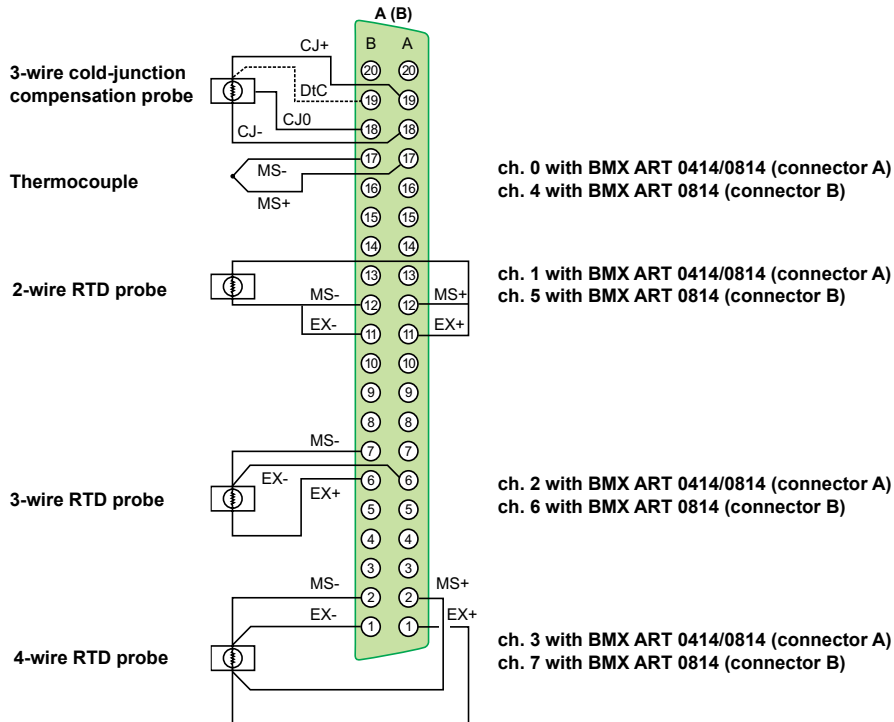

MS+: Input + RTD probe or thermocouple
 MS-: Input - RTD probe or thermocouple
 EX+: Output + RTD probe current generator
 EX-: Output - RTD probe current generator

BMX FCW 301S/501S preformed cordsets with 40-way connector and flying leads

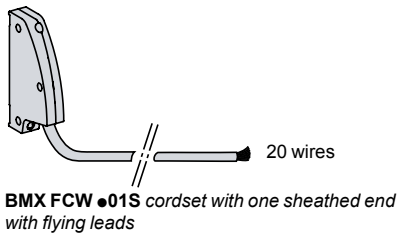

Connector pin No.	Color at sheath end	BMX ART 0414/0814 (A)	BMX ART 0814 (B)	Label
B20	N/C	–	–	
A20	N/C	–	–	
B19	White/blue	Cold-junction compensation	Cold-junction compensation	DTC
A19	White/amber			CJ+
B18	Blue/white			CJ0
A18	Amber/white			CJ-
B17	White/brown	Input - ch. 0	Input - ch. 4	MS-
A17	Brown/white	Input + ch. 0	Input + ch. 4	MS+
B16	White/green	I - generator ch. 0	I - generator ch. 4	EX-
A16	Green/white	I + generator ch. 0	I + generator ch. 4	EX+
B15	N/C	–	–	–
A15	N/C	–	–	–
B14	N/C	–	–	–
A14	N/C	–	–	–
B13	N/C	–	–	–
A13	N/C	–	–	–
B12	Red/blue	Input - ch. 1	Input - ch. 5	MS-
A12	Blue/red	Input + ch. 1	Input + ch. 5	MS+
B11	White/gray	I - generator ch. 1	I - generator ch. 5	EX-
A11	Gray/white	I + generator ch. 1	I + generator ch. 5	EX+
B10	N/C	–	–	–
A10	N/C	–	–	–
B9	N/C	–	–	–
A9	N/C	–	–	–
B8	N/C	–	–	–
A8	N/C	–	–	–
B7	Red/green	Input - ch. 2	Input - ch. 6	MS-
A7	Green/red	Input + ch. 2	Input+ ch. 6	MS+
B6	Red/amber	I - generator ch. 2	I - generator ch. 6	EX-
A6	Amber/red	I + generator ch. 2	I + generator ch. 6	EX+
B5	N/C	–	–	–
A5	N/C	–	–	–
B4	N/C	–	–	–
A4	N/C	–	–	–
B3	N/C	–	–	–
A3	N/C	–	–	–
B2	Red/gray	Input - ch. 3	Input - ch. 7	MS-
A2	Gray/red	Input + ch. 3	Input + ch. 7	MS+
B1	Red/brown	I - generator ch. 3	I - generator ch. 7	EX-
A1	Brown/red	I + generator ch. 3	I + generator ch. 7	EX+

BMX FTW 301S/501S preformed cordsets with 20-way terminal block at one and flying leads at the over

Correspondence between terminal block way and colored of wire

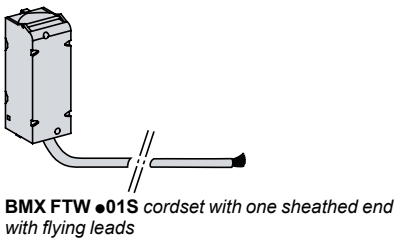

Terminal block way No.	Color at sheath end	BMX AMI 0410	BMX AMO 0210	BMX AMM 0600
1	Blue/white	V input ch. 0	–	V input ch. 0
2	White/blue	Common ch. 0	–	I input ch. 0
3	Amber/white	I input ch. 0	Output ch. 0	–
4	White/amber	–	Common ch. 0	–
5	Green/white	–	–	Common ch. 0
6	White/green	–	–	V input ch. 1
7	Brown/white	V input ch. 1	–	I input ch. 1
8	White/brown	Common ch. 1	–	Common ch. 1
9	Gray/white	I input ch. 1	–	V input ch. 2
10	White/gray	–	–	I input ch. 2
11	Blue/red	V input ch. 2	–	Common ch. 2
12	Red/blue	Common ch. 2	–	V input ch. 3
13	Amber/red	I input ch. 2	–	I input ch. 3
14	Red/amber	–	–	Common ch. 3
15	Green/red	–	–	–
16	Red/green	–	–	–
17	Red/brown	V input ch. 3	Output ch. 1	Output ch. 0
18	Brown/red	Common ch. 3	Common ch. 1	Common ch. 0
19	Gray/red	I input ch. 3	–	Output ch. 1
20	Red/gray	–	–	Common ch. 1

2

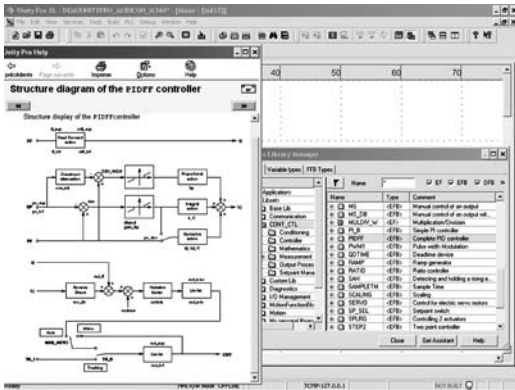

CONT_CTL, programmable process control integrated in Unity Pro

Process control in machines

Unity™ Pro contains CONT_CTL, a library of 36 function blocks used to create control loops for machine control.

Requirements for closed loop control functions in machines are met using Modicon® M340™/Premium™/Quantum™ platforms' wealth of library functions and flexibility. Function blocks can be linked together through programming. This solution eliminates the need for external controllers and simplifies the overall control architecture of the machine, as well as its design, roll-out and operation.

The function blocks, EF or EFB, can be used in any Unity Pro languages, such as LD, ST, IL and FBD. FBD is particularly suitable for accessing control processing operations in Unity Pro through its assistant for entering and viewing parameters and function block variables.

CONT_CTL library functions

The library consists of five function families:

- Input data conditioning
- Controllers
- Math functions
- Measurement processing
- Output value processing

Input data conditioning

DTIME	Pure delay
INTEGRATOR	Integrator with limiting
LAG_FILTER	First order time lag device
LDLG	PD device with smoothing
LEAD	Differentiator with smoothing
MFLOW	Mass flow calculation based on the measurement of differential pressure or flow speed with pressure and temperature compensation
QDTIME	Deadtime device
SCALING	Scaling
TOTALIZER	Integrator (typically of flow) until a limit (typically a volume) is reached, with automatic reset
VEL_LIM	Velocity limiter, with manipulated variable limiting

Controllers

PI_B	Simple PI controller: PI algorithm with a mixed structure (series/parallel)
PIDFF	Complete PID controller: PID algorithm with a parallel or mixed structure (series/parallel)
AUTOTUNE	Automatic tuner setting for the PIDFF (complete PID) controller or the PI_B (simple PI) controller <ul style="list-style-type: none"> □ Identification using Ziegler Nichols type method □ Modeling based on 1st order process □ Building of control parameters with criterion for prioritizing either the reaction time to disturbance (dynamic) or the stability of the process
IMC	Model corrector. The model is a first order model with delay. This corrector is useful: <ul style="list-style-type: none"> □ When there are serious delays compared with the main time constant of the process; this scenario cannot be satisfactorily resolved by standard PID process control □ For regulating a non-linear process IMC can handle any stable and aperiodic process of any order.
SAMPLETM	Control of controller startup and sampling
STEP2	Two-point controller
STEP3	Three-point controller for temperature regulation

Math functions

COMP_DB	Comparison of two values with dead zone and hysteresis
K_SQRT	Square root with weighting and threshold, useful for linearization of flow measurements
MULDIV_W	Weighted multiplication/division of 3 numerical values
SUM_W	Weighted summation of 3 numerical values

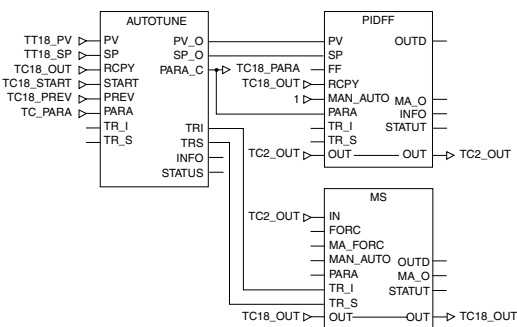

Example: PID controller with MS manual control

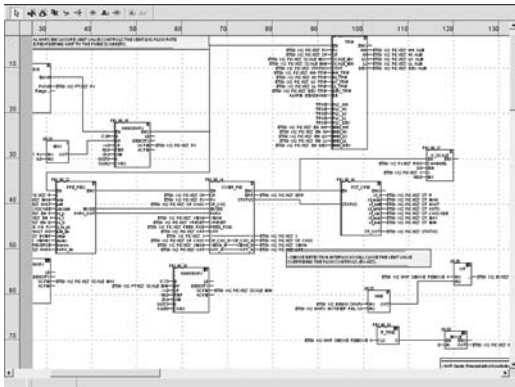

Programming in Unity™ Pro in offline mode

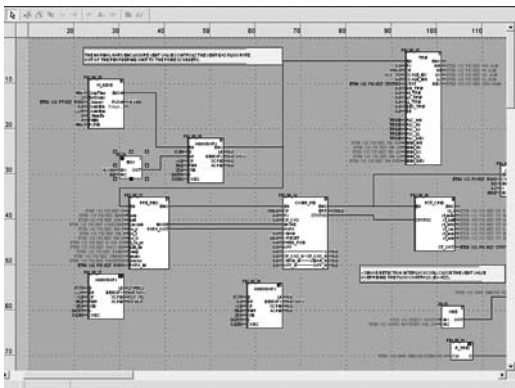

Programming in online mode

CONT_CTL library functions (continued)

Measurement processing

AVGMV	Moving average with fixed number of samples (50 max.)
AVGMV_K	Moving average with constant correction factor, 10,000 samples max.
DEAD_ZONE	Dead zone
LOOKUP_TABLE1	Linearization of characteristic curves using first-order interpolation
SAH	Detection of a rising edge
HYST_XXX	Detection of high threshold with hysteresis (1)
INDLIM_XXX	Detection of high and low thresholds with hysteresis (1)

Output value processing

MS	Manual control of an output
MS_DB	Manual control of an output with dead zone
PWM1	Control via pulse width modulation
SERVO	Control for servo motors
SPLRG	Control of two <i>Split Range</i> actuators

Setpoint management

RAMP	Ramp generator, with separate ascending and descending ramps
RATIO	Ratio controller
SP_SEL	Selection of setpoint value: local (operator) or <i>remote</i> (processing)

Setup

Setting up process control function blocks

Based on the sequencing of function blocks, the FBD language integrated into Unity Pro is a programming language particularly suitable for building control loops. Designers can use FBD to easily associate blocks from the CONT_CTL library with their own DFB blocks written in Unity Pro's ST, IL or LD language, or in C language.

Debugging, operation

Unity Pro's standard debugging services (see page 4/23) are available. In particular, the Modicon® M340™ processor simulator can be used to check correct execution of processing offline.

Compatibility

The CONT_CTL control function block library is available in any version of Unity Pro. It is compatible with processors in the Modicon M340, Premium™, Quantum™, and Atrium™ ranges.

Resources

The technical documentation provides many examples of how to setup programmable process control function blocks in FBD, LD, IL and ST languages.

The techniques for adjusting process control loops are described in the document "Process control, Unity V3.0" available on the www.schneider-electric.us/ website.

(1) XXX is dependent on the type of variable (such as, DINT, INT, UINT, UDINT, REAL).

Modicon® M340™ automation platform

Distributed I/O system

2

Splitter box and module type

Monobloc I/O splitter boxes
Modicon® FTB



Type of communication with Modicon® M340™ platform

CANopen

Max. number per connection points

1 monobloc splitter

Discrete inputs/outputs	Number of channels	Splitter of 16 I, 8 I + 8 O, 12 I + 4 O, 16 I/O or 8 I + 8 I/O
	Input voltage	≡ 24 V
	Output voltage	≡ 24 V

Splitter of 16 I, 8 I + 8 O, 12 I + 4 O, 16 I/O or 8 I + 8 I/O

≡ 24 V

≡ 24 V

Analog inputs/outputs

–

Counting

–

Type of input/output connectors

M12 connectors

Housing type

Plastic and metal

Module type



Pages

Consult our catalog pages at: www.schneider-electric.us/

Monobloc IP 20 distributed I/O

Modicon® Momentum™



Optimum IP 20 distributed I/O

Modicon® OTB



Modular IP 20 distributed I/O

Modicon® STB



Ethernet Modbus®/TCP
1 base with 1 communicator
Base of 16 I, 32 I, 8 O, 16 O, 32 O, 10 I/8 O, 16 I/8 O, 16 I/12 O and 16 I/16 O
⎓ 24 V, ~ 120 V and ~ 230 V
⎓ 24 V, ~ 120 V and ~ 230 V and relay
Bases 8 I, 16 I or 4 O voltage/current Base 4 I thermocouple or RTD
Base 2 channels 10 kHz/200 kHz
Base 6 I/3 O ~ 120 V with 1 Modbus port
Screw or spring terminal blocks
Plastic

Ethernet Modbus/TCP CANopen Modbus (RS 485)
1 interface module + 7 Twido® I/O extension modules
12 I/8 O (interface module) 8 I, 16 I, 32 I, 8 O, 16 O, 32 O, 4I/4O and 16 I/8 O (extension modules)
⎓ 24 V and ~ 120 V
⎓ 24 V and relay
2 I, 4 I, 8 I, 1 O, 2 O, 2 I/1 O and 4 I/2 O (extension modules) Voltage/current, Thermocouple or Temperature probe
Integrated in interface module: - 2 channels 5 kHz/20 kHz - 2 PWM function channels
Removable screw terminal blocks (interface module) Removable screw or non-removable spring terminal blocks or HE 10 connector (extension modules)

Ethernet Modbus/TCP CANopen
1 "NIM" interface module + 32 I/O modules
Module of 2 I, 4 I, 6 I, 16 I, 2 O, 4 O, 6 O or 16 O
⎓ 24 V, ~ 115 V and ~ 230 V
⎓ 24 V, ~ 115/230 V and relay
Modules 2 I and 2 O voltage/current Module 2 I thermocouple or RTD
Module 1 channel 40 kHz
Parallel interface module for TeSys® Quickfit® and TeSys U motor-starters Screw or spring connectors

Consult our catalog

"Modicon Momentum automation platform"

OTB 1•O DM9LP

Consult our catalog
"Modicon OTB distributed I/O"

Consult our catalog

"Modicon STB distributed I/O"

Modicon® M340™ automation platform

BMX EHC 0200/0800 counter modules

Introduction

BMX EHC 0200 and **BMX EHC 0800** counter modules for the Modicon® M340™ automation platform are used to count the pulses generated by a sensor or to process the signals from an incremental encoder.

The two modules differ in the number of counter channels, maximum input frequencies, functions and auxiliary input and output interfaces.

Counter module	No. of channels	Maximum frequency	Integrated functions	No. of physical inputs	No. of physical outputs
BMX EHC 0200	2	60 kHz	Upcounting Downcounting Period meter Frequency meter Frequency generator Axis control	6	2
BMX EHC 0800	8	10 kHz	Upcounting Downcounting Measurement	2	–

The sensors used on each channel:

- 2-wire 24 V proximity sensors
- 3-wire 24 V proximity sensors
- 10/30 V output signal incremental encoders with push-pull outputs

BMX EHC 0200 / 0800 counter modules are used to meet the demands of applications such as:

- Alarm generation on empty unwinder status using the ratio
- Sorting small parts using the period meter
- Single electronic cam using the dynamic setting thresholds
- Speed control using the period meter

These standard format modules can be installed in any available slot of a Modicon M340 PLC; and can be removed while powered up.

In a Modicon M340 PLC configuration, add the number of **BMX EHC 0200 / 0800** counter modules to the number of application-specific modules (communication). The function parameters are set by configuring the Unity™ Pro software.

Description

BMX EHC 0200 / 0800 counter I/O modules are standard format. They occupy a single slot in **BMX XBP ●●00** racks.

They come in a plastic case that helps to ensure IP 20 protection of the electronics, and locks into position with a screw.

BMX EHC 0200 module, 2 channels, 60 kHz

The **BMX EHC 0200** counter module has the following on the front panel:

- 1 Module and channel status LED array
- 2 16-way connector for wiring the sensors of counter 0
- 3 16-way connector for wiring the sensors of counter 1
- 4 10-way connector for wiring:
 - the auxiliary outputs
 - the sensor power supplies

To be ordered separately:

- A **BMX XTS HSC 20** kit containing two 16-pin connectors and one 10-pin connector
- A **BMX XSP 010** electromagnetic compatibility kit (see page 1/15).

BMX EHC 0800 module, 8 channels, 10 kHz

The **BMX EHC 0800** counter module has the following on the front panel:

- 1 Module and channel status LED array
- 2 Connector taking a **BMX FTB 20●0 3** removable terminal to lock (cage clamp, screw clamp or spring-type).

To be ordered separately:

- 3 A **BMX FTB 20●0 20**-way removable terminal block (cage clamp, screw clamp or spring-type)
- a **BMX XSP 010** electromagnetic compatibility kit (see page 1/15).

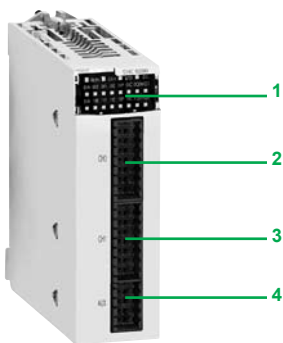

BMX EHC 0200

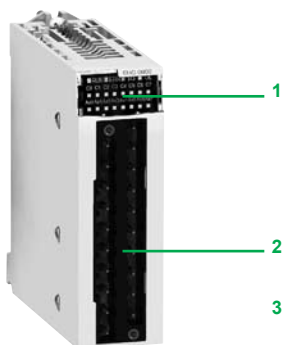

BMX EHC 0800



BMX FTB 20●0

Operation

Block diagram of a BMX EHC 0200 module counter channel

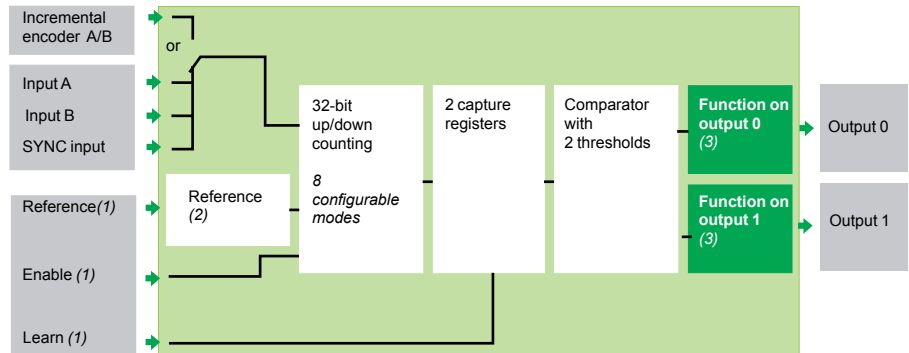

Block diagram of a BMX EHC 0800 module counter channel

Used in 16-bit (8 channels)

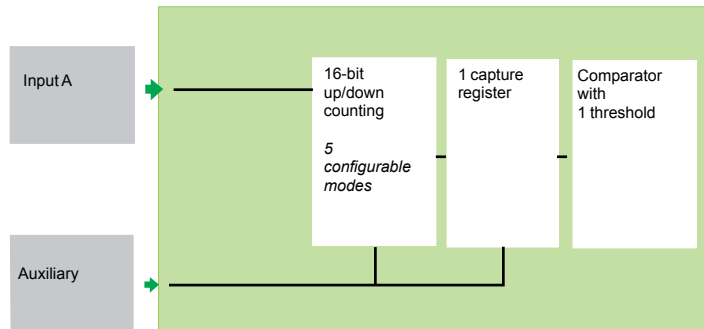

Used in 32-bit (4 channels)

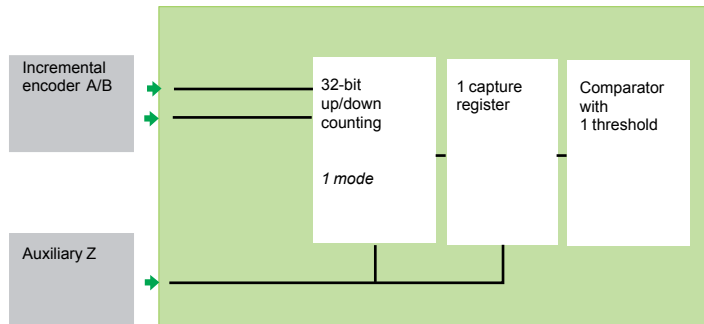

(1) Optional inputs.
 (2) Reference: 5 operating modes for IN_SYNC and IN_REF inputs.
 (3) Functions of inputs: 15 possible types of behavior.

Functional specifications of the BMX EHC 0200 module

8 configurable modes	Frequency meter	<p>This mode measures a frequency, speed, data rate or an event stream. As standard, this mode measures the frequency received on the IN A input. This frequency is always expressed in Hz (number of pulses per second), with a precision of 1 Hz.</p> <p>The maximum frequency on the IN A input is 60 kHz. The maximum cyclic ratio at 60 kHz is 60%.</p>
	Count events	<p>This mode is used to determine the number of events received intermittently. In this mode, the counter calculates the number of pulses applied to the IN_A input, at time intervals defined by the user.</p> <p>The module counts the pulses applied to the IN_A input each time the pulse for this input lasts longer than 5 µs (without anti-bounce filter).</p>
	Measure time periods	<p>This mode is used to:</p> <ul style="list-style-type: none"> ■ Determine how long an event lasts for ■ Determine the time that separates 2 events ■ Time and measure the execution time of a process <p>Measures the elapsed time during an event or between two events (IN_A input) according to a selectable time base of 1 µs, 100 µs or 1 ms. The IN_SYNC input can be used to enable or stop a measurement.</p> <p>The module can carry out a maximum of 1 measurement every 5 ms. The smallest measurable pulse is 100 µs, even if the unit defined by the user is 10 µs. The maximum measurable duration is 4,294,967,295 units (unit to be defined).</p>
	Ratio count	<p>The ratio count mode only uses the IN_A and IN_B inputs. This count mode consists of 2 modes:</p> <ul style="list-style-type: none"> ■ Ratio 1: used to divide 2 frequencies and useful in applications such as flowmeters and mixers, for example. ■ Ratio 2: used to subtract 2 frequencies and useful in the same applications but requiring more precise regulation (more similar frequencies). <p>Ratio 1 mode presents the results in thousandths to provide better accuracy (a display of 2000 corresponds to a value of 2) and ratio 2 mode presents the results in Hz.</p> <p>The maximum frequency that the module can measure on the IN_A and IN_B inputs is 60 kHz.</p>
	Downcounting	<p>This mode is used to list a group of operations. In this mode, activation of the synchronization function starts the counter. The counter starts with a preset value and decreases with each pulse applied to the IN_A input until it reaches the value 0. This downcounting is made possible when the enable function has been activated. The counting register is thus updated at intervals of 1 ms. One basic use of this mode is to signal, using an output, the end of a group of operations (when the counter reaches 0).</p> <p>The smallest pulse applied to the IN_SYNC input is 100 µs. The frequency applied to the IN_SYNC input is at maximum 1 pulse every 5 ms. The maximum value of the preset value is 4,294,967,295. The maximum count value is 4,294,967,295 units.</p>
	Loop (modulo) counting	<p>This mode is used in packaging and labeling applications where actions are repeated on series of moving objects.</p> <ul style="list-style-type: none"> ■ In the counting direction, the counter increases until it reaches the preset "modulo - 1" value. On the next pulse, the counter is reset to 0 and counting restarts. ■ In the downcounting direction, the counter decreases until it reaches the value 0. On the next pulse, the counter is reset to the preset "modulo - 1" value. Downcounting can then restart. <p>The maximum frequency applied to the IN_A and IN_B inputs is 60 kHz. The frequency of the modulo event is at maximum 1 every 5 ms. The maximum modulo value is 4,294,967,296 (possible with modulo adjust value is 0) .</p>
	32-bit counter counting	<p>This mode is used mainly in axis following.</p> <p>The maximum frequency applied simultaneously to the IN_A and IN_B inputs is 60 kHz. The frequency of the referencing event is at maximum 1 every 5 ms. The counter value is between - 2,147,483,648 and + 2,147,483,647.</p>
	Width modulation	<p>In this operating mode, the module uses an internal clock generator to supply a periodic signal on the module output Q0. Only the Q0 output is affected by this mode, the Q1 output being independent of this mode.</p> <p>The maximum output frequency value is 4 kHz. As the Q0 output is source type, a load resistor is needed for the Q0 output signal to change to 0 at the correct frequency. The cyclic ratio adjustment range varies according to the frequency of the Q0 output.</p>

Functional specifications of the BMX EHC 0800 module

5 configurable modes in 16-bit	Frequency meter	This mode measures a frequency, speed, rate or data stream control. As standard, this mode measures the frequency received on the IN A input. This frequency is always expressed in Hz (number of pulses per second), with a precision of 1 Hz. The maximum frequency on the IN A input is 10 kHz. The maximum cyclic ratio at 10 kHz is 60%.
	Count events	This function is used to determine the number of events received intermittently. In this mode, the counter calculates the number of pulses applied to the IN_A input, at time intervals defined by the user. As an option, it is possible to use the IN_AUX input during a period of time, provided that the enable bit has indeed been configured. The module counts the pulses applied to the IN_A input each time the pulse for this input lasts longer than 50 µs (without anti-bounce filter). Pulses with less than 100 ms synchronization are lost.
	Downcounting	This mode is used to list a group of operations. In this mode, when counting is enabled (software validation via the valid_sync command), a rising or falling edge on the IN_AUX input causes a value, defined by the user, to be loaded in the counter. The latter decreases on each pulse applied to the IN_A input, until it reaches the value 0. Downcounting is made possible when the force_enable command is high (software positioning). The smallest pulse applied to the IN_AUX input varies according to the selected filter level. The frequency applied to the IN_AUX input is at maximum 1 pulse every 25 ms.
	Loop (modulo) counting	This mode is used in packaging and labeling applications where actions are repeated on series of moving objects. The counter increases on each pulse applied to the IN_A input, until it reaches the preset "modulo - 1" value. On the next pulse in the upcounting direction, the counter is reset to 0 and upcounting restarts. The maximum frequency applied to the IN_A input is 10 kHz. The smallest pulse applied to the IN_AUX input varies according to the selected filter level. The frequency applied to the IN_AUX input is at maximum 1 pulse every 25 ms. The frequency of the modulo event is at maximum 1 every 25 ms. The maximum modulo value is 65,536 units.
	Up/down counter	This mode is used for an accumulation, upcounting or downcounting operation on a single input. Each pulse applied to the IN_A input produces: <ul style="list-style-type: none"> ■ Upcounting of pulses if the IN_AUX input is high ■ Downcounting of pulses if the IN_AUX input is low The counter values vary between the limits - 65,536 and + 65,535. The maximum frequency applied to the IN_A input is 10 kHz. Pulses applied to the IN_A input, after a change of direction, are only upcounted or downcounted after a period corresponding to the delay for taking account of the state of the IN_AUX input due to the programmable filter level on this input.
One mode in 32	32-bit counter counting	32-bit counter counting mode is available for channels 0, 2, 4, and 6 (channels 1, 3, 5 and 7 are now inactive). It behaves in the same way as the up/down counting mode using up to 3 physical inputs. It enables simultaneous upcounting and downcounting. The counter values vary between the limits -2,147,483,648 and +2,147,483,647 (31 bits +sign). The maximum frequency applied to the IN_A and IN_B inputs is 10 kHz. The smallest pulse applied to the IN_AUX input is defined according to the filtering applied to this input. The frequency of loading the preset value is at maximum 1 every 25 ms.

General specifications

Type of module		BMX EHC 0200	BMX EHC 0800
		32-bit	16-bit 32-bit
Modularity		2 channels	8 channels
Number of physical inputs per module		6 per channel	2 per channel 6 per channel
Number of physical outputs per module		2 per channel	–
Applications		Upcounting, downcounting, measurement, frequency meter, frequency generator, axis following	Upcounting, downcounting, measurement, interfacing
Configurable modes		8 modes	5 modes 1 mode (Dual phase)
Frequency on counter inputs	kHz	Max. 60	Max. 10
Module cycle time	ms	1	5
Encoder		10...30 V incremental encoder model with push-pull outputs	– 10...30 V incremental encoder model with push-pull outputs
Distribution of power to the sensors		Yes. Short-circuit and overload protection, 300 mA typical	–
Hot swapping		Yes, in certain conditions: the module can be removed and reinserted in its slot while the rack is powered up, but the counter may need to be re-enabled when it is reinserted in its base.	
Insulation voltage from the ground to the bus	V rms	1500 for 1 min	
Consumption	Typical	mA	See Power consumption table on page 6/13

Input specifications

Module type		BMX EHC 0200	BMX EHC 0800	
			16-bit 32-bit	
Input type	High-speed inputs per channel	IN_A, IN_B and IN_SYNC	IN_A and IN_AUX IN_A/IN_B and IN_AUX	
	Auxiliary inputs per channel	IN_EN, IN_REF and IN_CAP	–	
Number of inputs per channel		6	2	
Inputs	Voltage	V	24 ---	
	IEC/EN 61131-2 conformity		Type 3	
	At state 1	Voltage	V	11...30 ---
		Current	mA	5 up to 30 V
	At state 0	Voltage	V	< 5 ---
		Current	mA	< 1.5
Current at 11 V ---		mA	> 2	

Specifications of outputs

Output type		BMX EHC 0200	BMX EHC 0800
Number of outputs per channel		2	–
Voltages	Nominal	V	24 ---
	Limits	V	19.2...30 ---
Maximum load current	Each point	A	0.5
	Per module	A	1
Leakage current	At state 0	mA	≤ 0.1
	At state 1	V	≤ 3
Short-circuit output current	Each point	A	< 1.5
Short-circuit and overload		Protection for each channel	
Output logic	Default	Positive (source) on both channels	
	User configuration	Negative (sink) on one or two channel(s)	
Inductive load		H A Hz	–
		L = 0.5/I ² × F where: - L: load inductance - I: load current - F: switching frequency	

Modicon® M340™ automation platform

BMX EHC 0200/0800 counter modules



BMX EHC 0200



BMX EHC 0800

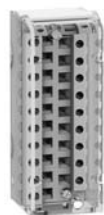

BMX FTB 2000

References

BMX EHC 0200/0800 counter modules

Description	No. of channels	Specifications	Reference	Weight kg
Counter modules for 2 and 3-wire 24 V \pm sensors and 10/30 V \pm incremental encoders with push-pull outputs	2	Counting at 60 kHz	BMX EHC 0200	0.112
	8	Counting at 10 kHz	BMX EHC 0800	0.113

Connection accessories (1)

Description	Composition Use	Unit reference	Weight kg
Connector kit	Two 16-pin connectors and one 10-pin connectors for BMX EHC 0200 module	BMX XTS HSC 20	0.021
20-way removable terminals blocks for BMH EHC 0800 module	Cage clamp	BMX FTB 2000	0,093
	Screw clamp	BMX FTB 2010	0,075
	Spring-type	BMX FTB 2020	0,060
Electromagnetic compatibility kits for BMX EHC 0200/0800 modules	Comprised of a metal bar and two sub-bases	See page 1/15	–

(1) The shielding on the cordsets carrying the analog signals must always be connected to the **BMX XSP●●00** shielding connection kit that is mounted under the rack holding BMX EHC 0200 modules. See page 1/15.

2

Connections

Connector pinout for BMX EHC 0200 module, 16-pin

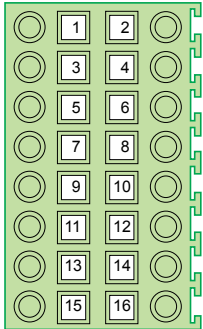

Pin number	Symbol	Description
1, 2, 7, 8	24V_SEN	+ 24 V $\overline{\text{---}}$ sensors
5, 6, 13, 14	GND_SEN	0 V $\overline{\text{---}}$ sensors
15, 16	FE	Functional earth ground
3	IN_A	Input A
4	IN_SYNC	Synchronization input
9	IN_B	Input B
10	IN_EN	Enable input
11	IN_REF	Referencing input
12	IN_CAP	Capture input

Connector pinout for BMX EHC 0200 module, 10-pin

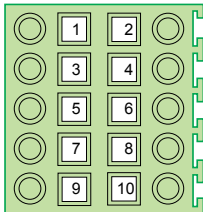

Pin number	Symbol	Description
1	24V_IN	24 V $\overline{\text{---}}$ input power supply
2	GND_IN	0 V $\overline{\text{---}}$ input power supply
5	Q0-1	Q1 output of counter channel 0
6	Q0-0	Q0 output of counter channel 0
7	Q1-1	Q1 output of counter channel 1
8	Q1-0	Q0 output of counter channel 1
9	24V_OUT	24 V $\overline{\text{---}}$ output power supply
10	GND_OUT	0 V $\overline{\text{---}}$ output power supply

Examples of connection to BMX EHC 0200 module

2-/3-way sensor

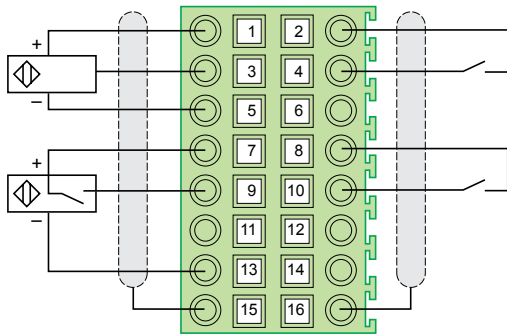

Incremental encoder

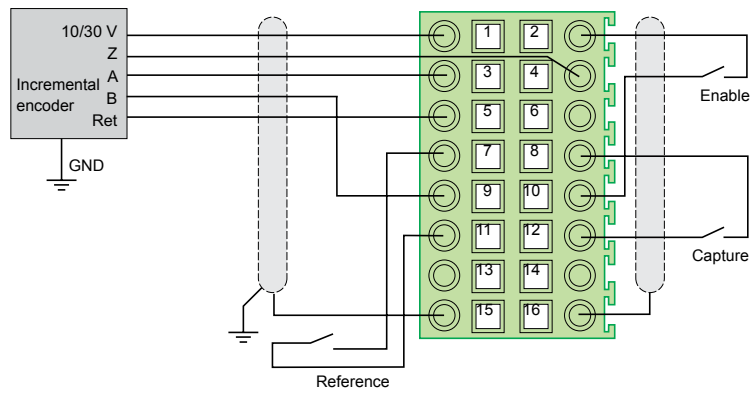

Power supplies and actuators

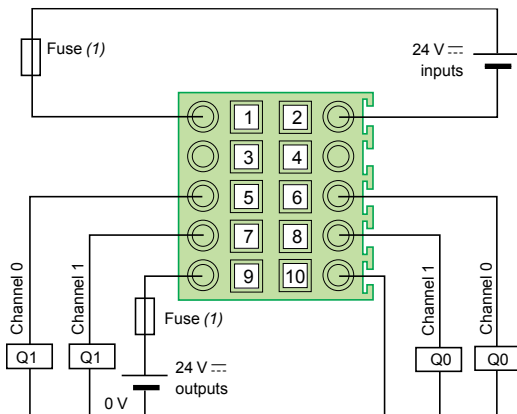

(1) A fast-blow fuse to protect the module electronics in the event of reversed polarity of the power supplies on I/O.

Connections (continued)

Connector pinout for BMX FTB 20•0, 20-way terminal block

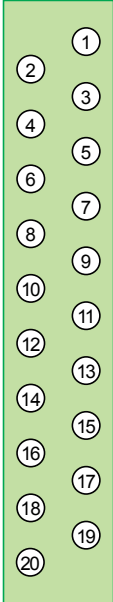

Pin number	Description
1	IN_AUX input of channel 0
2	IN_A input of channel 0
3	IN_AUX input of channel 1
4	IN_A input of channel 1 or IN_B input of channel 0
5	IN_AUX input of channel 2
6	IN_A input of channel 2
7	IN_AUX input of channel 3
8	IN_A input of channel 3 or IN_B input of channel 2
9	IN_AUX input of channel 4
10	IN_A input of channel 4
11	IN_AUX input of channel 5
12	IN_A input of channel 5 or IN_B input of channel 4
13	IN_AUX input of channel 6
14	IN_A input of channel 6
15	IN_AUX input of channel 7
16	IN_A input of channel 7 or IN_B input of channel 0
17	0 V --- sensors
18	+ 24 V --- sensors
19	Functional ground, for shielding connection
20	Functional ground, for shielding connection

Examples of connection to BMX EHC 0800 module

Connection of sensors (1) (2) (3)

Connection of an incremental encoder (1) (2) (3)

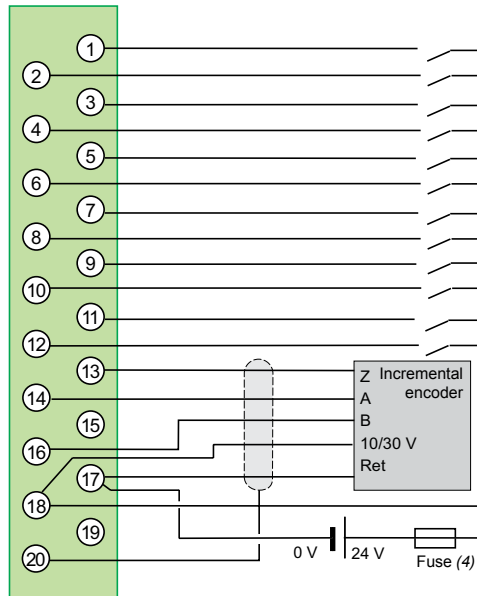
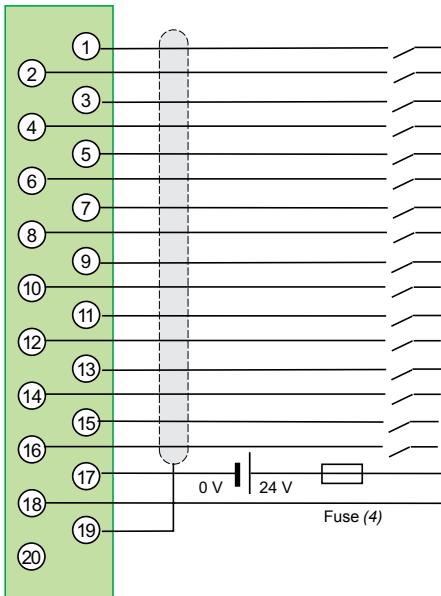

- (1) Program the filtering to the frequency applied to the inputs to eliminate the need to use a shielded cable.
- (2) If the encoder or a high-speed sensor does not have programmable filtering, use a shielded cable connected to 15 and 16 pin connectors.
- (3) In the case of a very disturbed environment without programmable filtering, use the **BMX XSP 010** electromagnetic protection kit to connect the shielding. In this case, use a 24 V --- power supply dedicated to the inputs and a shielded cable for connecting the power supply to the module.
- (4) A fast-blow fuse to protect the module electronics in the event of reversed polarity of the power supplies.

Modicon® M340™ automation platform

BMX MSP 0200 motion control module

2

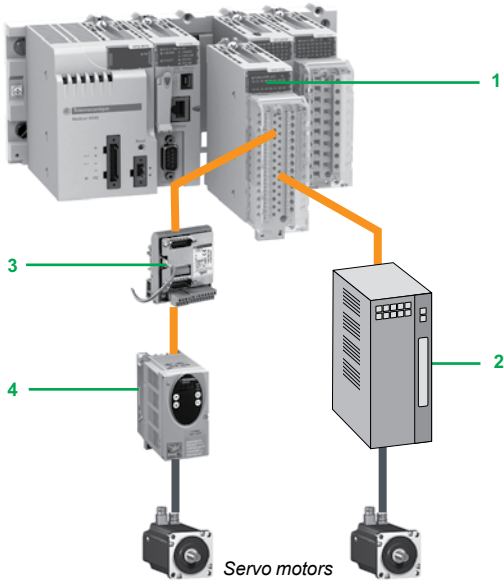

Introduction

The BMX MSP 0200 motion control pulse train output (PTO) module 1 for the Modicon® M340™ automation platform is used for controlling third-party servo drives 2 that have an integrated position loop and inputs that are compatible with open collector outputs.

By using the USIC converter, **VW3 M3 102, 3**, to adapt 24 V $\overline{\text{DC}}$ control signals to the RS 422 standard, the **BMX MSP 0200** control module is compatible with the Lexium® 05 servo drive range 4.

The **BMX MSP 0200** motion control PTO module has 2 independent PTO channels. Like any application-specific module, it is mounted in any available slot of the rack (labelled 01 to 11). The number of modules is limited by the maximum number of application-specific channels permitted according to the CPU type:

- Standard **BMX P34 1000**: maximum of 20 application-specific channels (1)
- Performance **BMX P34 2000**: maximum of 36 application-specific channels (1)

(1) Application-specific channels: counter **BMX EHC 0000**, motion control **BMX MSP 0200** and communication **BMX NOE 0100**.

Description

The **BMX MSP 0200** motion control module is standard format (1 slot). Its housing provides IP 20 protection of the electronics and is locked in each slot (01 to 11) by a captive screw.

The **BMX MSP 0200** motion control module front panel comprises:

- 1 A rigid body providing support and protection for the electronic card
- 2 A module reference marking (a label is also visible on the right-hand side of the module)
- 3 A LED array for displaying:
 - Module status, 4 LEDs (RUN, ERR, I/O and DL)
 - Status of the auxiliary inputs, 4 per channel
 - Status of the PTO outputs, 2 per channel
 - Status of the auxiliary outputs, 2 per channel
- 4 A connector for a 28-way terminal block, for connecting to a removable spring terminal block on sensors and preactuators

To be ordered separately:

- 5 A 28-way removable spring terminal block **BMX FTB 2820**, supplied with a channel identification label
 - A shielding connection kit to protect against electrostatic discharge, consisting of a metal bar and 2 base units for mounting on the rack: **BMX XSP 0000** (the reference depends on the number of slots in the rack)
 - A set of clamping rings DA573516.eps for the connection cable shielding braids (the reference depends on the cable \varnothing)

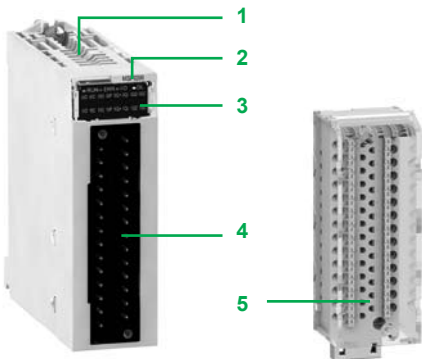

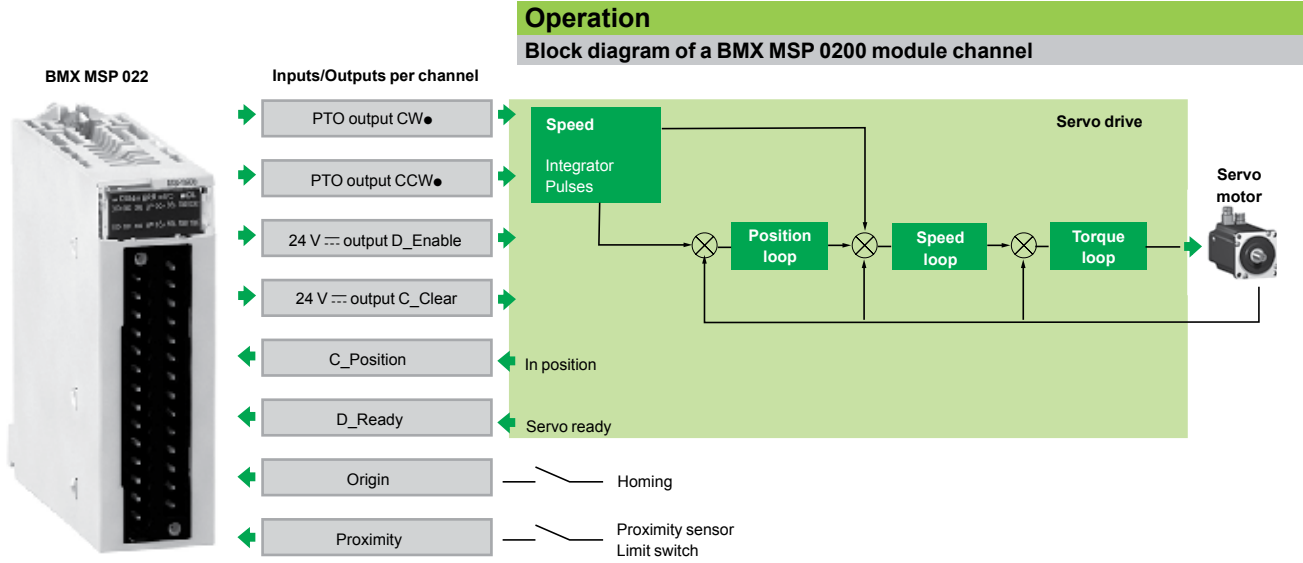

Operating specifications

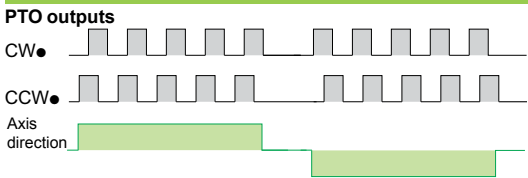

3 pulse train output modes can be configured:

- Clockwise pulses (CW●)/counter-clockwise pulses (CCW●)
- Pulses (CW●)/direction (CCW●)
- Shifted pulses: A/B phases (CW●/CCW●)

Each of these 3 modes has a corresponding inverse mode. The frequency of the PTO pulses defines the velocity of the axis and the number of PTO pulses determines the position of the axis.

Movement commands

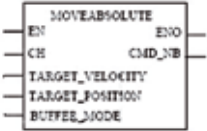

Movement commands with associated command parameters are sent from the Unity Pro user program in one of 2 ways:

- PTO-specific elementary functions (EFs)
- WRITE_CMD explicit exchange instruction

The family of PTO-specific elementary functions consists of the following 6 instruction types:



FrequencyGenerator Function enabling the PTO channel to supply a pulse train at a given frequency (0 to 200 kHz). A complex generator profile can be used by the same command to modify the target frequency.



MoveVelocity Function used for generating a pulse train at a specified frequency via an acceleration ramp. 4 complex movement velocity profiles are offered to achieve the following:

- Modify the target velocity to a higher or lower velocity
- Modify the target velocity during the acceleration or deceleration phase
- Define a deceleration ramp when the target velocity is lower than the previous velocity
- Abort the current command for a new movement command

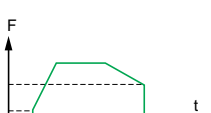

MoveAbsolute Function for defining a complete movement of the axis (trapezoidal profile with acceleration, velocity and deceleration) from the current position to a target position specified with respect to an origin.

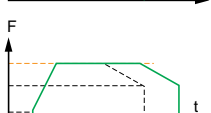

MoveRelative Function for defining a complete movement of the axis (trapezoidal profile with acceleration, velocity and deceleration) from the current position to a target position specified by its distance in pulses. This function is supplemented by the following functions:

- Modification on the fly of the target position (timing diagram opposite)
- Stopping and change of direction where the target position is overrun
- Management of the positioning buffer mode (abort, buffering, etc.)

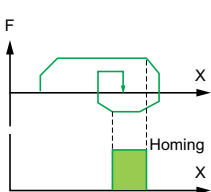

Homing Function enabling the axis to search for a reference point using 1 of 6 modes (short cam, positive/negative long cam, short cam with positive/negative limit, short cam with marker).

SetPosition Function defining an origin and reference position for the axis by assigning it an absolute coordinate at the current position (function without movement command).

Stop command

Function causing a smooth stop of the axis via a deceleration ramp regardless of the movement in progress or its current phase. Sent only by explicit exchange.

Modicon® M340™ automation platform

BMX MSP 0200 motion control module

2

General specifications

Module type		BMX MSP 0200	
Modularity		2 channels	
No. of inputs		4 per channel	
No. of outputs		2 PTO (<i>Pulse Train Output</i>) outputs and 2 "Discrete" outputs per channel	
Applications		Independent linear axis control for simple machines for: - Packaging, labeling - Material handling (simple hoist, grouping/ungrouping) - Assembly	
Movement commands		5 types representing a total of 23 different profiles, with a reference point command and a stop command	
PTO outputs	Frequency (1)	kHz	200 max. in clockwise/counter-clockwise pulse mode 200 max. in pulse/direction mode 100 max. in shifted pulse (A/B phases) mode
	Number of pulses		- 2,147,483,648 to 2,147,483,647 (32 bits)
	Accuracy		
Hot swapping		Yes, subject to certain conditions. The module can be unplugged from and plugged into its rack slot with the power on (with module enabling, if necessary)	
Insulation resistance		MΩ	> 10 at 500 V $\overline{\text{---}}$
Dielectric strength	Primary/secondary	V rms	1500 for 1 min.
	Between channel groups		–
Operating temperature		°C	- 25 to 70 without derating
Current required	Typical	mA	See the Power consumption table on page 6/13.

Input specifications

Inputs per channel		Drive_Ready, Counter_in_Position		Origin (2), Proximity&Limit Switch	
No. per channel		V	4		
Nominal values	Voltage	V	24 $\overline{\text{---}}$ (sensor power supply 19...30 V including ripple)		
	Current	mA	4.3		
IEC/EN 61131-2 conformity		Type 3			
Limit values	At state 1	Voltage	V	11...30 $\overline{\text{---}}$	
		Current	mA	> 2 for $U \geq 11$ V $\overline{\text{---}}$	
	At state 0	Voltage	V	< 5 $\overline{\text{---}}$	
		Current	mA	< 1.5	
Input logic		Positive or negative (<i>sink/source</i>)		Positive (<i>sink</i>)	
Response time	Without anti-bounce filter	μs	< 200		
	With programmable anti-bounce filter	ms	2.7 - 3.5 or 6.3		2.45 - 3.25 or 6.3 (3)
Reverse polarity		Protected			
Compatibility with 2-wire/3-wire sensors		IEC 947-5-2			
Paralleling of inputs		Yes			
Sensor voltage monitoring	Voltage OK	V	> 12		
	Voltage out of range	V	< 8		

Output specifications

Output type		PTO outputs		Auxiliary outputs	
No. per channel		2		2	
Nominal values	Voltage	V	24 $\overline{\text{---}}$		
	Current	mA	50		
	Output frequency	kHz	See PTO outputs above in the General Specifications section	6	
Limit values	Voltage	V	19...30 $\overline{\text{---}}$		
	Current	Per point	mA	100 with electronic tripping threshold at 130 mA	
		Per channel	mA	400	
Leakage current	At state 0	μA	≤ 50		
Residual voltage	At state 1	mV	≤ 150		
Load		Resistive, impedance 15 kΩ min., capacity 100 nF max.			
Built-in protection against	Overvoltage	No			
	Reverse polarity	Yes, by reverse-mounted diode			
	Short circuit and overload	Yes, by current limiter and electronic breaker per channel			
Preactuator voltage monitoring	Voltage OK	V	> 14		
	Voltage out of range	V	< 8		
	Response time	ms	1.2 < T < 1.5 on disappearance or appearance		
Servo drive compatibility		Compatible with any servo drive equipped with the following inputs: - 24 V $\overline{\text{---}}$ negative logic (<i>source</i>) or positive logic (<i>sink</i>) - 5 V $\overline{\text{---}}$ RS 422 or 24 V $\overline{\text{---}}$ polarization - "line driver" differential RS 422 using the 24 V/RS 422 USIC converter VW3 M3 102 (for Lexium 05, for example)			

1) Maximum frequency permitted with module/servo drive connection cable ≤ 10 m. Connection cable for module/USIC converter **VW3 M3 102** ≤ 0.5 m with Lexium® 05 servo drive (max. frequency 200 kHz).

2) Input to be used with the homing command.

3) In homing mode: 450 μs, 1.25 or 4.1 ms.

Modicon® M340™ automation platform

BMX MSP 0200 motion control module

References



BMX MSP 2820

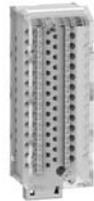

BMX MSP 0200



VW3 M3 102

Motion control modules

Designation	Number of channels	Description per channel	Reference	Weight kg
PTO module (PTO = Pulse Train Output)	2	2 x 200 kHz max. PTO outputs 2 x 24 V \pm 50 mA auxiliary outputs 4 x 24 V \pm auxiliary inputs	BMX MSP 0200	0.145

Connection accessories

Designation	Description, use	Length	Reference	Weight kg
28-way removable terminal block	Spring-type	–	BMX FTB 2820	0.080
RS 422 converter (USIC)	USIC = Universal Signal Interface Converter. Used to connect the PTO outputs of the BMX MSP 0200 module to the RS 422 interface of a servo drive (Lexium® 05, for example)	–	VW3 M3 102	–
Connection cables for USIC converter	From the BMX MSP 0200 module (screw terminal block) to the VW3 M3 102 USIC converter (15-way SUB-D connector) (cable with flying leads at one end and a 15-way SUB-D connector at the other)	0.5 m (1) (2)	VW3 M8 210 R05	–
		1.5 m	VW3 M8 209 R15	0.030
		3 m	VW3 M8 209 R30	0.040
	From the VW3 M3 102 USIC converter (15-way SUB-D connector) to the Lexium 05 servo drive (10-way Molex connector) (cable fitted with one 15-way SUB-D connector and one 10-way Molex connector)	5 m	VW3 M8 209 R50	0.050

(1) To maintain performance, limit the length of the cable connecting the **BMX MSP 0200** PTO module to the **VW3 M3 102** USIC converter to 0.5 m.

(2) Input to be used with the homing command.

Modicon® M340™ automation platform

BMX MSP 0200 motion control module

Connections

Pinout of the BMX FTB 2820 28-way terminal



Terminal no.		Terminal no.	
2	D_Ready + input, channel 0	1	D_Ready - input, channel 0
4	C_Position + input, channel 0	3	C_Position - input, channel 0
6	Origin input, channel 0	5	Proximity input, channel 0
8	CW output, channel 0	7	CCW0 output, channel 0
10	D_Enable output, channel 0	9	C_Clear output, channel 0
12	Power supply 0 V (GND)	11	Power supply 0 V (GND)
14	D_Ready + input, channel 1	13	D_Ready - input, channel 1
16	C_Position + input, channel 1	15	C_Position - input, channel 1
18	Origin input, channel 1	17	Proximity input, channel 1
20	CW output, channel 1	19	CCW0 output, channel 1
22	D_Enable output, channel 1	21	C_Clear output, channel 1
24	Power supply 0 V (GND)	23	Power supply 0 V (GND)
26	Power supply +24 V	25	Power supply +24 V
28	Functional ground, for shielding connection	27	Functional ground, for shielding connection

Channel 0 terminals Channel 1 terminals

Power supply 0 V terminals 11-12-23-24 are interconnected via the **BMX MSP 0200** module.
Power supply +24 V terminals 25-26 are interconnected via the **BMX MSP 0200** module.
Functional ground terminals 27-28 are interconnected via the **BMX MSP 0200** module.

Example of connecting channel 0 to a servo drive: negative logic 24 V ⋯ inputs (source) and negative logic 24 V ⋯ outputs (sink)

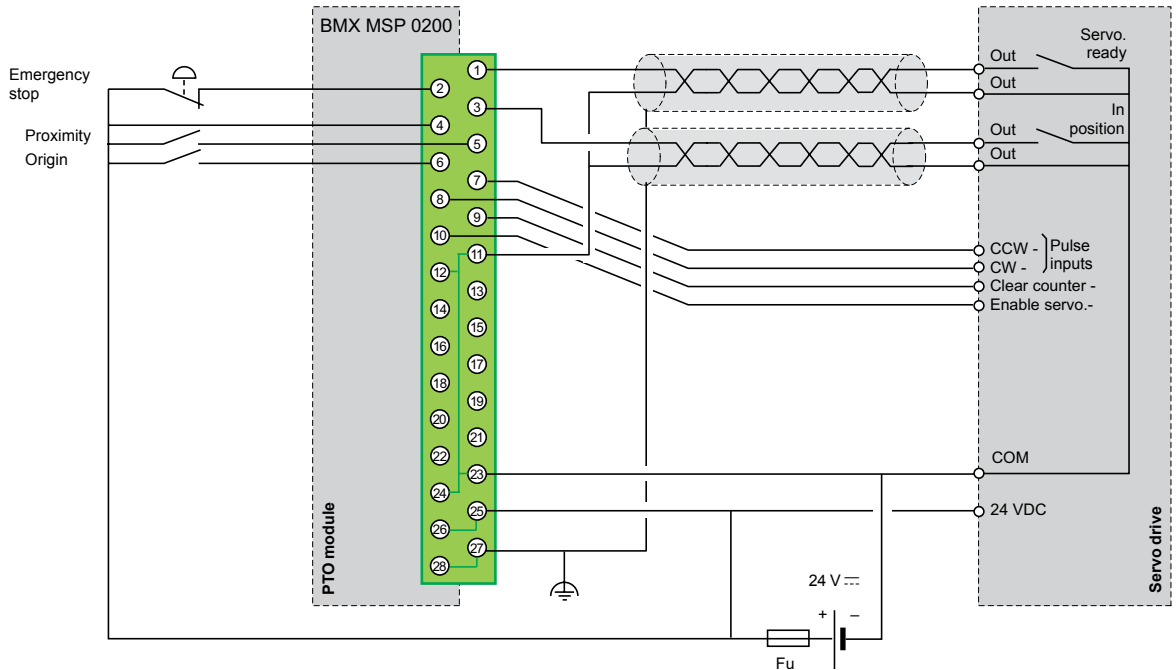

Connections (continued)

Example of connecting channel 0 to a servo drive thru RS 422 differential inputs

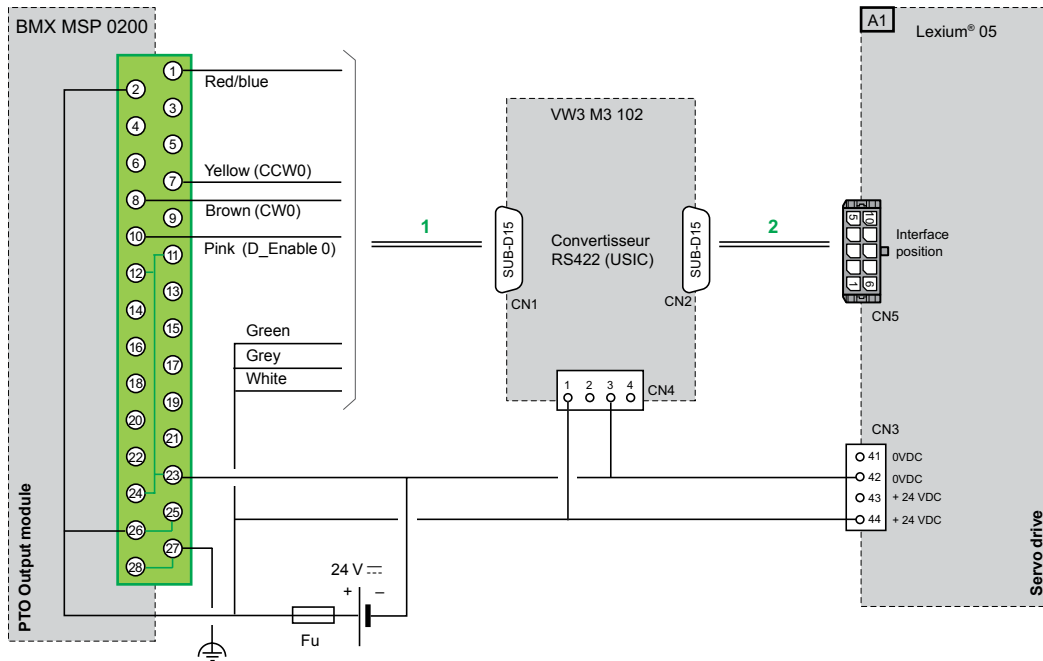

- 1 Cable VW3 M8 210 R05 equipped with flying leads at one end, length 0.5 m.
- 2 Cable VW3 M8 209 R15/R30/R50 equipped at both ends, length 1.5 m, 3 m and 5 m.

Connection with other compatible servo drives (for servo drive compatibility, see Specifications on page 2/48):
for other connections, please consult our website www.schneider-electric.us/

Dimensions

RS 422 (USIC) converter
VW3 M3 102

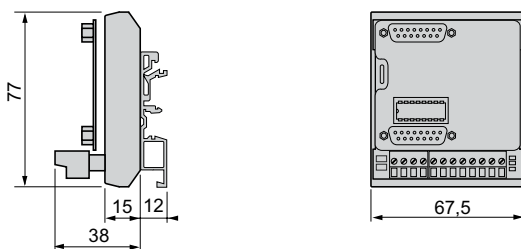

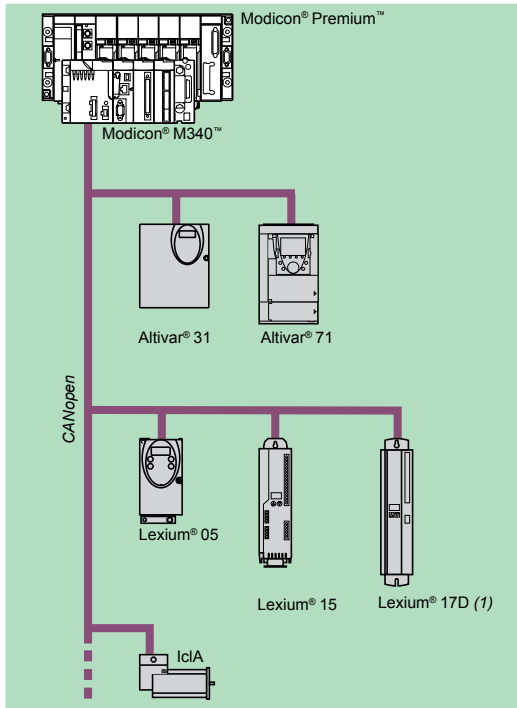

MFB: Motion control distributed over CANopen

Introduction

Motion Function Blocks (MFB) is a library of function blocks integrated in Unity™ Pro used to setup motion control in the architectures of drives and servo drives on CANopen buses:

- Altivar 31: For asynchronous motors from 0.18 to 15 kW
- Altivar 71: For asynchronous motors from 0.37 to 500 kW
- Lexium 05: For servo motors from 0.4 to 6 kW
- Lexium 15LP/MP/HP: For BSH and BDH servo motors from 0.9 to 42.5 kW
- Lexium 17D: For BPH, BPL and SER servo motors from 1.5 to 70 A rms (1)
- IclA IFA/IFE/IFS: For integrated motor drives from 0.05 to 0.25 kW

In compliance with PLCopen specifications, the MFB library allows both easy and flexible motion programming with Unity Pro, as well as axis diagnosis. In maintenance operations, drives can be replaced quickly using drive parameter download blocks.

Setting up drives on the CANopen network is facilitated through Motion Tree Manager organization in the Unity Pro browser, making it easy for users to access the application drives.

Applications

The features of the Motion Function Blocks library are particularly suitable for machines with independent axes. In the case of these modular/special machines, MFB function blocks are the perfect solution for controlling single axes. The following are typical applications for this type of architecture:

- Automatic storage/removal
- Material handling
- Palletizers/depalletizers
- Conveyors
- Packaging, simple label application
- Grouping/ungrouping
- Adjustment axes in flexible machines, etc.

Functions

The table below lists the function blocks of the MFB library and their compatible drives. The prefix indicates the block family:

- MC: Function block defined by the Motion Function Blocks PLCopen standard
- TE: Function block specific to Schneider Electric products
- Lxm: Function block specific to Lexium servo drives



Type	Function	Function block	Altivar 31	Altivar 71	Lexium 05	Lexium 15 HP/MP/LP	Lexium 17D (1)	IclA IFA/IFE/IFS
Management and motion	Read an internal parameter	MC_ReadParameter						
	Write an internal parameter	MC_WriteParameter						
	Read the current position	MC_ReadActualPosition						
	Read the instantaneous speed	MC_ReadActualVelocity						
	Acknowledge error messages	MC_Reset						
	Stop all active movement	MC_Stop						
	Axis coming to standstill	MC_Power						
	Movement to absolute position	MC_MoveAbsolute						
	Relative movement	MC_MoveRelative						
	Additional movement	MC_MoveAdditive						
	Homing	MC_Home						
	Movement at given speed	MC_MoveVelocity						
	Read diagnostic data	MC_ReadAxisError						
	Read servo drive status	MC_ReadStatus						
	Torque control command	MC_TorqueControl						
Reading of actual torque value command	MC_ReadActualTorque							
Manual move command	MC_Jog					Except 15LP		
Save and restore parameters (FDR)	Read all parameters and store in PLC memory	TE_UploadDriveParam						
	Write all parameters from the PLC memory	TE_DownloadDriveParam						
Advanced Lexium functions	Set the reduction ratio	Lxm_GearPos						
	Read a motion task	Lxm_UploadMTask						
	Write a motion task	Lxm_DownloadMTask						
	Start a motion task	Lxm_StartMTask						
	Set the reduction ratio, signed	Lxm_GearPosS						
System	Communication with the servo drive	TE_CAN_Handler						

Compatible

(1) Lexium 17D supported by MFB with Modicon® Premium™ platform only.

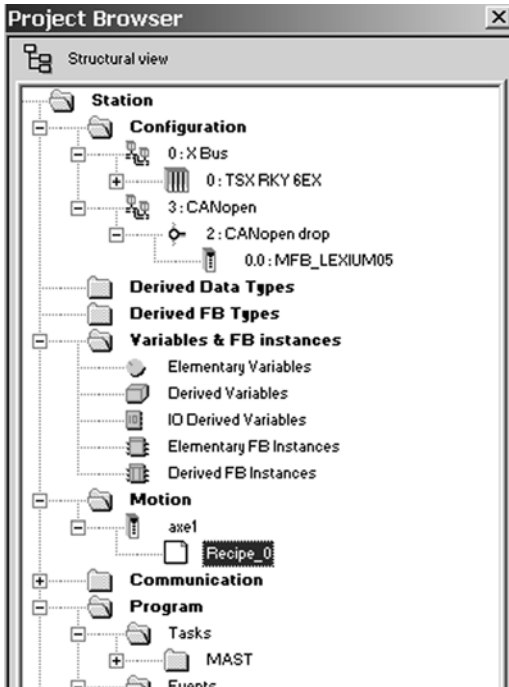

Motion Tree Manager integrated in the Unity™ Pro browser

Motion Tree Manager

Motion Tree Manager is associated with Unity™ Pro's MFB library and integrated in its browser. It provides specific assistance for:

- Axis object management
- Axis variable definition
- Drive parameter management

Motion Tree Manager automatically creates links between the CANopen bus configuration and the MFB function block data using a limited amount of configuration data.

General axis parameters

In this tab, the designer is prompted to define:

- The name of the axis that will identify it in the browser for the entire application
- The address of the drive on the CANopen bus

Axis parameters

The drop down lists in this tab are used to determine the exact type of drive (family, version).

Variable names

This last tab is used to identify data structures:

- **Axis_Reference:** Used by each instance of function blocks for the axis in question
- **CAN_Handler:** Used to manage communication with the drive via the CANopen network

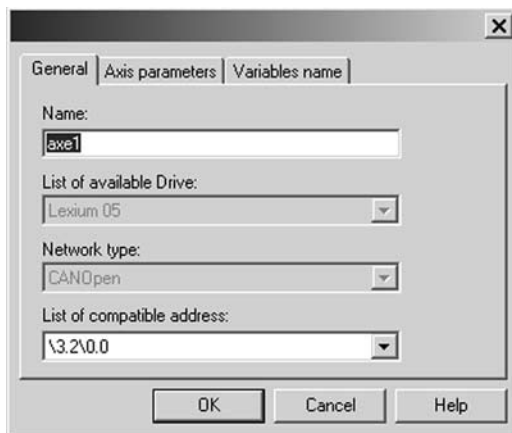

General parameters: Axis name and address

Recipe definition

The "recipes" attached to the axis are the data structures containing all the adjustment parameters of a given drive. This data is used when:

- Changing the drive with restoration of the context during "Faulty Device Replacement" (FDR) maintenance
- Changing the manufacturing program of the machine and calling up an appropriate set of parameters, such as servo control gains, limitations, and so on, adapted to the weight and size of the moving parts
- Saving parameters in the initial values of the PLC application

Programming, diagnostics and maintenance

Communication between the PLC and drive is automatically set up by the system as soon as a TE_CAN_Handler instance is declared in the Unity Pro task with which the axis is associated. Movements are then programmed by sequencing function blocks from the library in the user's chosen Unity Pro editor (LD, ST, FBD).

The two function blocks, MC_ReadStatus, and in some cases MC_ReadAxisError, are useful for determining the overall status of the axis, as well as the code of active warnings or detected errors.

The function blocks TE_UploadDriveParam and TE_DownloadDriveParam allow the application to save the parameters of a drive (recipe) and to then quickly reload them into another drive if the first one becomes inoperative.

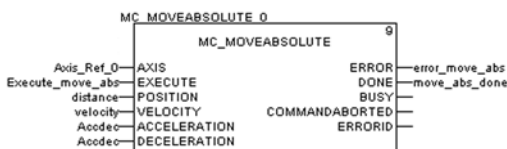

MFB: Programming a movement in absolute mode

Communication selection guide 3/2

3.1 - Ethernet Modbus®/TCP network

- Embedded Web services
 - Standard web server 3/4
 - FactoryCast™ web server 3/5
 - SOAP/XML Web services 3/6
- Ethernet Modbus/TCP communication services
 - Introduction 3/8
 - Ethernet universal services 3/9
 - Modbus communication protocol 3/11
 - I/O Scanning service 3/12
 - FDR replacement service for faulty devices 3/13
 - NTP time synchronization service 3/13
 - Global Data service 3/14
 - SNMP network management service 3/15
- Performance 3/16
- Description, specifications and references
 - Ethernet solutions with Modicon® platforms 3/21
 - Processors with integrated Ethernet port 3/21
 - Ethernet Modbus/TCP modules 3/21
- ConneXium™ cabling systems
 - Infrastructure 3/24
 - Connection components 3/26
 - Hub and transceiver 3/28
 - Unmanaged switches 3/30
 - Managed switches 3/33

3.2 - CANopen machine and installation bus

- Introduction 3/38
- Connectable devices 3/38
- Description 3/40
- Specifications 3/40
- References 3/41
- Wiring system 3/42

3.3 - Serial link

- Modbus and character mode serial link
 - Introduction, description 3/44
 - Specifications 3/45
 - References 3/45
- Wiring system 3/46



Modicon® M340™ automation platform

Communication, integrated ports and modules

Applications

Processors with integrated Ethernet Modbus®/TCP port

Ethernet Modbus/TCP modules



3

Type

Structure	Physical interface
	Connector type
	Access method
	Data rate

Medium

Configuration	Maximum number of devices
	Maximum length
	Number of links of the same type per station
	Other integrated port

Standard services

Conformity class

Embedded web server services	Standard services
	Configurable services

Transparent Ready communication services	I/O Scanning service
	Global Data service
	NTP time synchronization
	FDR service
	SMTP E-mail notification service
	SOAP/XML Web services
	SNMP network management service
	Bandwidth management

Compatibility with processor

Processor or module

Page

Ethernet Modbus/TCP

10BASE-T/100BASE-TX	
RJ45	
CSMA-CD	
10/100 Mbit/s	
Double twisted pair copper cable, category CAT 5E Optical fiber via ConneXium™ wiring system	
-	
100 m (copper cable), 4,000 m (multi-mode optical fiber), 32,500 m (single-mode optical fiber)	
1 (integrated port)	With BMX P34 1000 processor: 1 Ethernet module
	With BMX P34 2000/2010 processor: 2 Ethernet modules
	With BMX P34 2020/2030 processor: 2 Ethernet modules and 1 processor integrated port
Serial link	CANopen bus
	-
Modbus®/TCP messaging	
Transparent Ready® class B10	Transparent Ready class B30
	Transparent Ready class C30
"Rack viewer" PLC diagnostics "Data editor" access to PLC data and variables	
-	"Alarm viewer" "Graphic Data Editor"
	Hosting and display of user web pages (14 Mb)
-	Yes
-	Yes
-	Yes (version module ≥ 2.0)
Yes (client)	Yes (client/server)
Yes, via EF function block of Unity Pro ≥ 4.0	-
-	-
-	Server
Yes	Yes
Yes	Yes
-	Standard and Performance processors

BMX P34 2020

BMX P34 2030

BMX NOE 0100

BMX NOE 0110

3/22

3/23

Processors with integrated machine and installation bus

Processors with integrated serial link



CANopen

ISO 11898 (9-way SUB-D connector)	
9-way SUB-D	
CSMA/CA (multiple access)	
20 Kbit/s...1 Mbit/s depending on distance	
Double shielded twisted pair copper cable	
63 (1)	
20 m (1 Mbit/s)...2,500 m (20 Kbit/s)	
1	
Serial link	Ethernet Modbus/TCP
- PDO implicit exchange (application data)	
- SDO explicit exchange (service data)	
Class M20	
-	
-	
-	
-	
-	Yes, via EF function block of Unity™ Pro ≥ 4.0
-	
-	
-	

Modbus® and Character mode

Non-isolated, 4-wire RS 232/2-wire RS 485	
RJ45	
Master/slave with Modbus link, Half duplex (RS 485)/Full duplex (RS 232) in character mode	
0.3...19.2 Kbit/s	
Double shielded twisted pair copper cable	
32 per segment, 247 max.	
15 m (non-isolated), 1,000 m with insulating case	
1	
-	CANopen
-	Ethernet Modbus/TCP
Read/write bits and words, diagnostics with Modbus link	
Send and receive character string in character mode	
-	
-	
-	
-	
-	
-	
-	
-	
-	

BMX P34 2010

BMX P34 2030

**BMX P34 1000
BMX P34 2000**

BMX P34 2010

BMX P34 2020

3/41

3/45

(1) The maximum is 63, and depends on the type of the devices that are connected. It may be necessary to create a memory space table. See pages 6/8 and 6/9.

Overview of the web services

In conformity with Schneider Electric Ethernet products (processors and Ethernet modules on Modicon® automation platforms, distributed I/O modules, variable speed drives and gateways), standard web functions are integrated in **BMX P34 2020/2030** processors and the **BMX NOE 0100/110** Ethernet network modules on the Modicon® M340™ platform.

From a simple Internet browser, the standard web server authorizes the following “ready-to-use” functions:

- Remote diagnostics and maintenance of products
- Display and adjustment of products (read/write variables, status)

With the **BMX NOE 0110** Ethernet network module supplied as standard with **BMX RWS FC032M** memory card, the web server also offers the following functions:

- Management of PLC alarms (system and application) with partial or total acknowledgement (ready-to-use Alarm Viewer function pages).
- Hosting and display of web pages created by the user.

The embedded web server is a realtime data server. The data can be presented in the form of standard web pages in HTML format and can be accessed using any web browser that supports the embedded Java code. The standard functions provided by the web server are supplied “ready-to-use” and do not require any programming of either the PLC or the client PC device supporting a web browser.

Standard web server on the Modicon M340 platform

Rack Viewer PLC diagnostics function

The Rack Viewer function can be used for PLC system and I/O diagnostics. It displays the following in realtime:

- LED status on the front panel of the PLC
- The PLC type and version
- The hardware configuration of the PLC including the status of the system bits and words
- Detailed diagnostics of:
 - I/O module channels or application-specific channels in the configuration
 - equipment connected on the CANopen bus.

Data Editor read/write function for PLC data and variables

The Data Editor function can be used to create tables of animated variables for realtime read/write access to PLC data in the form of lists.

Various animation tables containing specific application variables to be monitored or modified can be created by the user and saved in the standard web server module.

In addition when using FactoryCast™ web server of the **BMX NOE 0110** module:

- The variables can be entered and displayed by their symbol (S_Pump 234)
- The write access option can be enable/disable for each variable using the FactoryCast software. The write access is protected by a dedicated password
- Dedicated data monitoring tool can be use on pocket PC or PDA terminal.

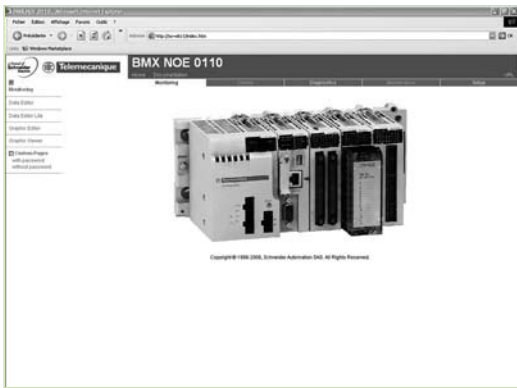

Modicon® M340™ hardware configuration



Data editor variables table

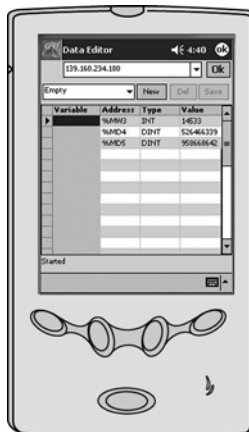



Alarm display from the diagnostic buffer

BMX NOE 0110 module FactoryCast™ web server

With the **BMX NOE 0110** Ethernet network module, the web server offers in addition to the standard web services, the functions below:

Alarm Viewer function

Alarm Viewer is a ready-to-use, password-protected function. This function can be used to process alarms (display, acknowledgment and deletion) managed at PLC level by the system or using diagnostic function blocks known as DFBs (system-specific diagnostic function blocks and application-specific diagnostic function blocks created by the user).

These alarms are stored in the diagnostic buffer managed by the Modicon M340 platform (special memory space for storing the diagnostics events).

The diagnostics viewer is a web page comprised of a list of messages that provide the following information for each alarm:

- Dates and times of the occurrence/removal of a detected fault
- Alarm message
- Alarm status
- Type of associated diagnostic function block (DFB)

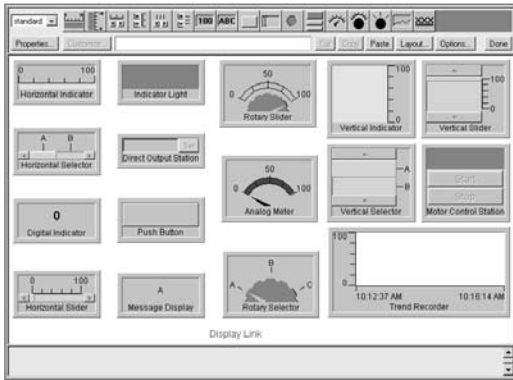

Library of predefined graphic objects

Graphic Data Editor function

This function is used to create the graphic views animated by the PLC variables that can be accessed via their address or their symbol (access to located data). The ready-to-use graphic editor is available online, connected to the **BMX NOE 0110** module.

These views are created from a library of predefined graphic objects by simple copy/paste operations. The objects are configured to suit the user's requirements (color, PLC variables, name, and so on).

List of proposed graphic objects:

- Analog and digital indicators
- Horizontal and vertical bar charts
- Boxes for displaying messages and entering values
- Push-button boxes
- Functions for recording trends
- Vats, valves, motors, and so on

Customized graphic objects can be added to this list. They can be reused in user web pages that have been created using standard software for editing HTML pages. The views created are saved in the **BMX NOE 0110** module and displayed using any web browser.

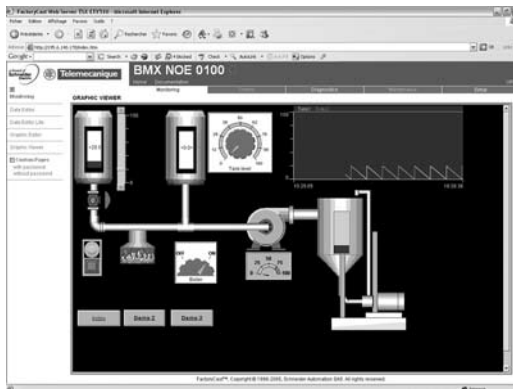

Realtime supervision graphic interface

User web page hosting and display function

The **BMX NOE 0110** Ethernet network module has a 16 Mbyte non-volatile memory (accessible as a hard disk). This allows hosting of web pages and any user-defined Word™ or Acrobat Reader™ document (for example, maintenance manuals, wiring diagrams, etc).

The web pages can be created using any standard tool for creation and editing in HTML format. These pages can be enhanced by inserting animated graphic objects linked to PLC variables. These animated objects are created using the Graphic Data Editor. They are then downloaded to the **BMX NOE 0110** module via configuration software of FactoryCast web server.

The web pages created can be used, for example, to:

- Display and modify PLC variables in real time
 - Create hyperlinks to other external web servers (documentation, suppliers)
- This function is particularly suitable for creating graphic interfaces used for the following purposes:
- Realtime display and supervision
 - Production monitoring
 - Diagnostics and help with maintenance
 - Operator guides

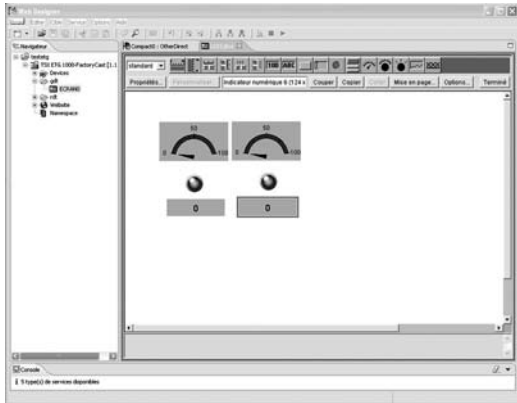

3

FactoryCast™ web server configuration software

The FactoryCast web server configuration software is supplied on CD-ROM with the **BMX NOE 0110** FactoryCast module.

This software is used for configuration and administration of the web server embedded in these modules. It is compatible with Microsoft® Windows 2000® and Windows XP® operating systems. It provides the following functions:

- Setting the parameters of the FactoryCast functions
- Definition of access security, passwords
- Importing of PLC symbol databases
- Definition of access to write-enabled variables
- Management of the web site:
 - Management of default web site pages
 - Management of user web site pages
 - Graphic object editor for animating web pages
 - Downloading of web pages between the PC and the module
 - Debugging of web pages in online mode or in simulation mode (including animations and Java™ beans)
- Simulation mode

The application and the web site (including the Java animations) can be set up in online mode or in simulation mode. Simulation mode is used to test the operation of the web application without a FactoryCast module (with no physical connection to a PLC) which simplifies debugging.

A graphics editor integrated in the configuration software can be used to easily customize graphic objects (bar charts, gauges, LEDs, curves, cursors, operator input fields, alphanumeric display fields, buttons, etc).

■ Creation of user web pages (1)

Web pages are created graphically using an external HTML editor (Microsoft® FrontPage® or similar, not supplied).

Web pages created in the FactoryCast environment are actual animated supervision screens used to monitor your process. Based on HTML and Java web technologies, they provide realtime access to PLC variables using the FactoryCast graphic object library (Java beans).



SOAP/XML web services

The **BMX NOE 0110** FactoryCast module incorporates a standard SOAP/XML data server that provides direct interoperability between automation devices and computer management applications (for example, MES, ERP, SAP, ●Net application).

SOAP/XML web Services embedded in the PLC

Communication between platforms or applications is now a necessity in a market where **e-manufacturing** and **e-business** are an essential fact of life for companies. web service technology currently represents the most successful strategy for helping to ensure interoperability of heterogeneous software applications via an Intranet or the Internet, independently of any platform, operating system and programming language.

The standardization of web services is a result of joint development between **Microsoft®** and **IBM®**, which was validated at the **W3C (World Wide Web Consortium)** as an open "standard". It now provides the tools, specifications and environments needed for each platform.

Web services are based on standards such as:

- **XML** (eXtensible Markup Language): the universal standard for data exchange
- **SOAP** (Single Object Access Protocol) protocol carried via the **HTTP** (Hyper Text Transfer Protocol) channel.
- **WSDL** (web Services Description Language) the web Services description language, in **XML** format.

SOAP is currently considered to be the reference protocol. It has been adopted by Microsoft (●NET, SQL Server, Office, etc), IBM (Java, web Sphere), Lotus, ORACLE, Sub, SAP, and others.

(1) FactoryCast includes a plug-in for Microsoft® FrontPage® 2000. This plug-in makes it easier to set up animations for realtime access to the PLC variables in user created HTML pages. Pages are created in the HTML editor by inserting customized graphic objects.

SOAP/XML web services (continued)

Embedded SOAP/XML web Services: ModbusXMLDa web services

This new Transparent Ready® service offers the previously unused (or uncommon) possibility of making an IT/e-business application interact directly with the control system levels using the same standards.

With the implementation of ModbusXMLDa (*Modbus® XML Data access*) web services in FactoryCast™ web servers, the IT engineer can easily create applications that will directly access the desired information in the PLC in real time. Data exchanges are made in XML standard format in response to a request using SOAP protocol.

The implementation of web services in control system equipment makes it easy to achieve vertical integration of the control level and the creation of even more collaborative architectures. These architectures can be used to link production systems to the corporate management systems. It brings simplified access to information, a reduction in the costs of training, development and deployments costs, plus an increase in productivity.

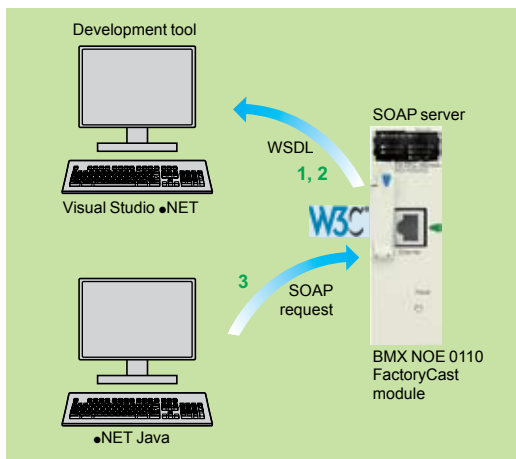

Implementation of the ModbusXMLDa web services: server interface

This implementation enables a SOAP client application (management level computer application, MES, ERP) to communicate directly with a FactoryCast web server module embedded in the PLC.

Exchanges are initiated by the SOAP client application and the server responds to these requests.

- **Step 1: Creation of the client application with web services training.** The development environment (for example, Visual Studio pNET) looks in the FactoryCast server for the list of available services and their WSDL standard interfaces provided by the module.
- **Step 2: Development of the client application.** The developer integrates the web service functions using the code retrieved during training.
- **Step 3: Execution of the client application.** The client application communicates in real time with the FactoryCast web server module using the SOAP protocol.

Requests implemented in the **BMX NOE 0110** FactoryCast module listed provide either physical or symbolic variables data access. They are defined in the table below.

	ModbusXMLDa functions implemented in each FactoryCast module
Access to data via physical address	ReadDeviceIdentification
	ReadMultipleRegisters
	WriteMultipleRegisters
	ReadCoils
	WriteMultipleCoils
	ReadDiscreteInputs
Access to data via symbol	Read, operation to read item list value
	Write, operation to write item list value
	Browse, operation to browse item list

Modicon® M340™ automation platform

Ethernet Modbus®/TCP network Ethernet Modbus/TCP communication services

Introduction

BMX P34 2020/2030 processors, via their integrated Ethernet port (class 10) and the **BMX NOE 0100/0110** network module (class 30) provide transparent communication on a single Ethernet Modbus®/TCP network.

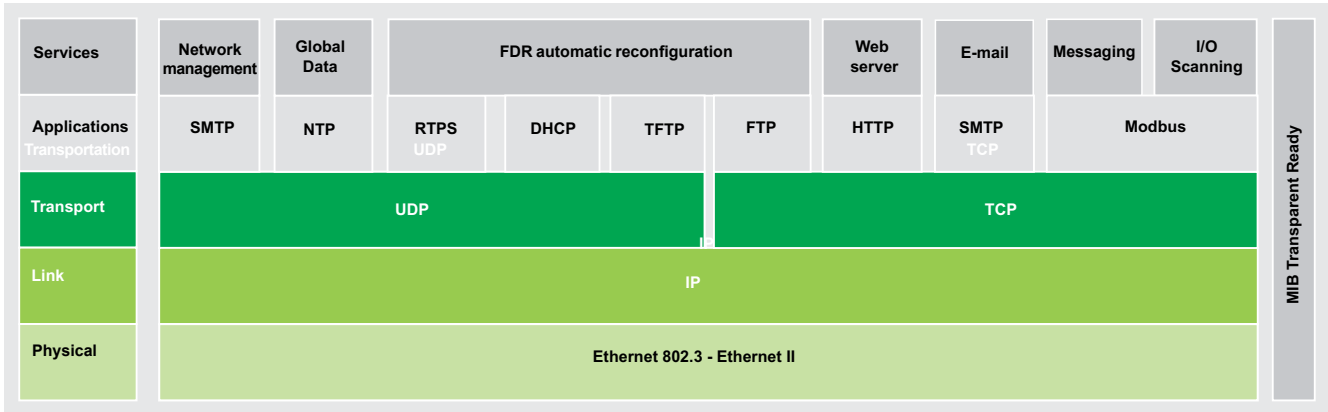

3

In addition to universal Ethernet services (HTTP, BOOTP/DHCP, and FTP) the Transparent Ready® device communication services designed for use in automation applications include:

- Modbus/TCP messaging for class 10 or 30 devices
- I/O Scanning service for class 30 devices
- FDR (Faulty Device Replacement) for class 10 or 30 devices
- SNMP (*Simple Network Management Protocol*) network management for class 10 or 30 devices
- Global Data, for class 30 devices
- Bandwidth management for class 10 or 30 devices
- NTP time synchronization (Network Time Protocol) for class 30 devices
- Electronic mail notification via SMTP server with function block of Unity Pro.

Note: The Ethernet Modbus/TCP communication services depends on the type of processor or Ethernet module. For details, see *Specifications of BMX P34 2020/2030* (page 3/22) or *BMX NOE 0100/0110 Ethernet modules* (page 3/23).

Pages 3/9 to 3/21 present the various options available through these services to facilitate the optimum choice of solutions when defining a system integrating Transparent Ready devices.

Functions

Ethernet universal services

HTTP "Hyper Text Transfer Protocol" (RFC1945)

The HTTP protocol (*HyperText Transfer Protocol*) is a protocol used to transmit Web pages between a server and a browser. HTTP has been used on the Web since 1990.

Web servers embedded in Transparent Ready® automation products provide easy access to products located anywhere in the world from a standard Internet browser such as Internet Explorer®.

BOOTP/DHCP (RFC1531)

BOOTP/DHCP is used to supply devices with IP parameters automatically. This avoids having to manage each device address individually by transferring this management to a dedicated IP address server.

The DHCP protocol (Dynamic Host Configuration Protocol) is used to assign configuration parameters to devices automatically. DHCP is an extension of BOOTP. The DHCP protocol consists of 2 components:

- One to supply the IP network address.
- One to supply the specific IP parameters to the device from a DHCP server.

Schneider Electric devices can be:

- BOOTP clients used to retrieve the IP address automatically from a server.
- BOOTP servers allowing the device to distribute IP addresses to the network stations.

Schneider Electric has used BOOTP/DHCP standard protocols to offer the FDR (Faulty Device Replacement) service.

FTP "File Transfer Protocol" (RFCs 959, 2228, and 2640)

File Transfer Protocol (FTP) provides the basic elements for file sharing. The FTP protocol is used by several systems to exchange files between devices.

TFTP "Trivial File Transfer Protocol" (updated firmware)

Trivial File Transfer Protocol (TFTP) is a network transfer protocol used to connect to a device and download code to it.

For example, it can be used to transfer a boot code to a workstation without a disk drive or to connect and download updates of network device firmware.

Note: *Transparent Ready devices implement FTP and TFTP to transfer certain information to or from products, in particular for downloads of firmware or user-defined Web pages.*

Functions (continued)

Ethernet universal services (continued)

SNMP "Simple Network Management Protocol" (RFCs 1155, 1156 and 1157)

The Internet community has developed the SNMP standard to manage the various network components via a single system. The network management system can exchange data with SNMP agent devices. This function allows the manager to display the status of the network and products, modify their configuration and feed back alarms in the event of a detected fault.

Note: Transparent Ready® products are compatible with SNMP and can be integrated naturally in a network administered via SNMP.

COM/DCOM "Distributed Component Object Model"

COM/DCOM (Distributed Component Object Model) or OLE (Object Linking and Embedding) is the name of the technology consisting of Microsoft® Windows® objects that enables transparent communication between Windows applications.

Note: These technologies are used in the OFS (OLE for Process Control Factory Server) data server software.

Modbus/TCP function codes		dec	hex
Bit access	Read n input bits	02	02
	Read n output bits	01	01
	Read exception status	07	07
	Write 1 output bit	05	05
	Write n output bits	15	0F
	Read 1 input word	04	04
	Read n input words	03	03
	Write 1 output word	06	06
	Write n output words	16	10
	Read device ID	43/14	2B/0E

Examples of Modbus/TCP function codes for accessing data and diagnostics.

Functions (continued)

Modbus® standard communication protocol

Modbus, the industry communication standard since 1979 has been brought together with Ethernet Modbus/TCP, the medium for the Internet revolution, to form Modbus/TCP, a totally open protocol on Ethernet. The development of a connection to Modbus/TCP does not require any proprietary component, nor purchase of a license.

This protocol can easily be combined with any product supporting a standard Modbus/TCP communication stack. The specifications can be obtained free of charge from the following web site: www.modbus-ida.org.

Modbus/TCP, simple and open

The Modbus application layer is very simple and universally familiar with its 9 million installed connections. Thousands of manufacturers are already using this protocol. Many have already developed a Modbus/TCP connection and numerous products are presently available.

The simplicity of Modbus/TCP enables a field device, such as an I/O module, to communicate on Ethernet without the need for a powerful microprocessor or a large amount of internal memory.

Modbus/TCP, high-performance

Due to the simplicity of its protocol and the fast speed of 100 Mbps Ethernet, the performance of Modbus/TCP is excellent. This allows this type of network to be used in realtime applications such as I/O scanning.

Modbus/TCP, a standard

The application protocol is identical on serial link Modbus, Modbus Plus or Modbus/TCP. This means that messages can be routed from one network to the other without converting protocol.

Since Modbus is implemented on top of the Modbus/TCP layer, users can also benefit from IP routing enabling devices located anywhere in the world to communicate without worrying about the distance between them.

Schneider Electric offers a complete range of gateways for connecting a Modbus/TCP network to existing Modbus Plus networks, a Modbus serial link or AS-Interface bus. Please consult your Regional Sales Office.

The IANA organization (Internet Assigned Numbers Authority) has allocated the fixed port TCP 502 ("Well known" port) to the Modbus protocol. Thus Modbus has become an Internet standard.

A study by the ARC Advisory Group, the market leader in analysis of the automation and software sectors, has shown that Modbus/TCP is the world-leading Ethernet industrial protocol in terms of units sold in 2004.

Modbus and Modbus/TCP are recognized by the IEC/EN 61158 international standard as a fieldbus. They are also compliant with the "Chinese National Standard" managed by ITEI.

Interfacing CANopen with Modbus/TCP

CiA DSP 309-2 provides standardized organization of CANopen data to be carried on a Modbus/TCP Ethernet network. The specification reserves the Modbus 43/13 function code for this purpose. This function code is reserved exclusively for CANopen.

Specifications of Modbus/TCP

Maximum size of data:

- Read: 125 words or registers
- Write: 100 words or registers

Functions (continued)
I/O Scanning service

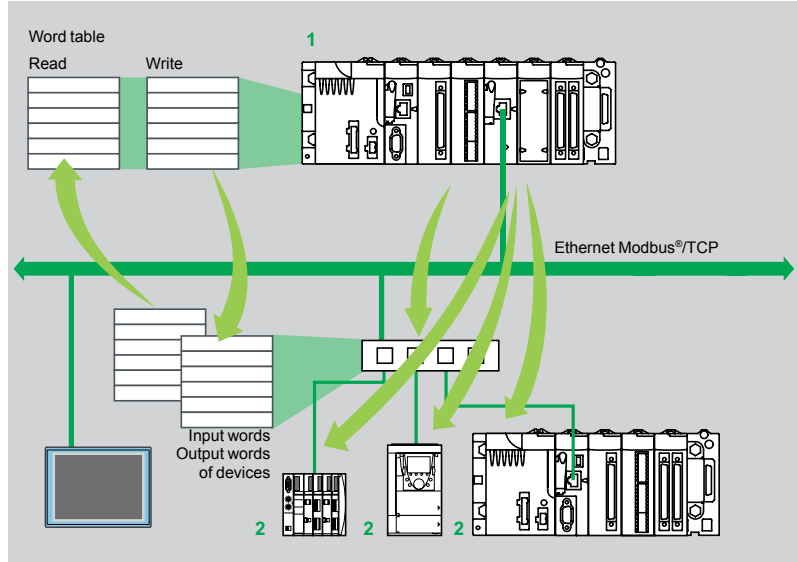

- 1 Modicon® M340™ equipment with I/O Scanning service supported by **BMX NOE 0100** Ethernet module.
- 2 Device supporting a modbus TCP messaging in server mode.

The I/O Scanning Service is used to manage the exchange of remote I/O states on the Ethernet network after simple configuration, without the need for any special programming.

I/O scanning is performed transparently by means of read/write requests according to the Modbus client/server protocol on the Modbus/TCP profile.

This scanning principle via a standard protocol is used to communicate between an equipment with the I/O Scanning service with any device supporting a Modbus TCP in mode server.

This service allows you to define:

- A%M word zone reserved for reading inputs.
- A%M word zone reserved for writing outputs.
- Refresh periods independent of the PLC scan.

During operation, the module:

- Manages Modbus/TCP connections for each remote device.
- Scans devices and copies the I/O to the configured %MW word zone .
- Feeds back status words used to check that the service is working correctly from the PLC application.
- Applies pre-configured fallback values if a communication problem occurs

An offer of hardware and software products used to implement the I/O Scanning protocol on any type of device that can be connected to the Ethernet network is available (please consult the Modbus-IDA web site: www.modbus-ida.org).

Specifications

- Each Modicon® M340™ station can exchange a maximum of:
 - 100 write words
 - 125 read words
- Maximum size in the Modicon M340 PLC that manages the service (64 stations max.) with **BMX NOE 0100/0110** network module, 2 %MW Kwords as inputs and 2 %MW Kwords as outputs.

Diagnostics of the I/O Scanning service

There are 5 ways to perform diagnostics on the I/O Scanning service:

- Via the application program from a specific PLC data zone.
- From the setup software debug screen.
- From the PLC system diagnostic function displayed by means of an internet browser on a PC station.
- From the ConneXium™ diagnostic software **TCS EAZ 01P SFE10**.
- From the standard SNMP manager software.

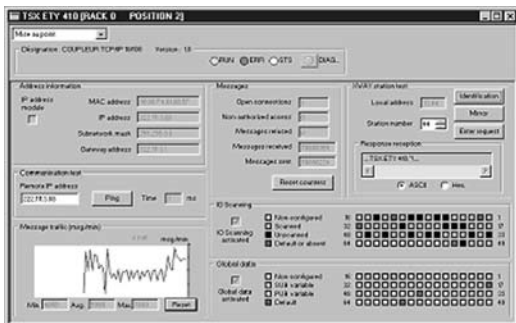

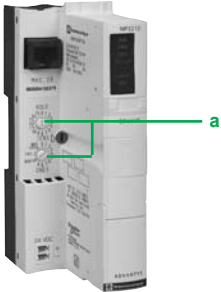

"NIM" network module for Modicon STB I/O

Functions (continued)

FDR (Faulty Device Replacement) service

The faulty device replacement service uses standard address management technologies (BOOTP, DHCP) and the TFTP (Trivial File Transfer Protocol) file management service, in the aim of simplifying maintenance of Ethernet products. It is used to replace an inoperative device with a new device that will be detected, reconfigured and automatically rebooted by the system.

The main steps in replacement are:

- 1 A device using the FDR service becomes inoperative.
- 2 Another similar device is taken from the maintenance store, preconfigured with the Device name for the inoperative device, then reinstalled on the network. Depending on the devices, addressing can be performed using spin buttons (for example, Modicon® STB distributed I/O, **a** or Modicon OTB) or can be given via the keypad integrated in the device (for example Altivar® variable speed drives).
- 3 The FDR server detects the new device, allocates it an IP address and transfers the configuration parameters to it.
- 4 The substituted device checks that these parameters are indeed compatible with its own specifications and switches to operational mode.

The FDR server can be a Ethernet module, **BMX NOE 0100/0110**.



NTP time synchronization service

Introduction

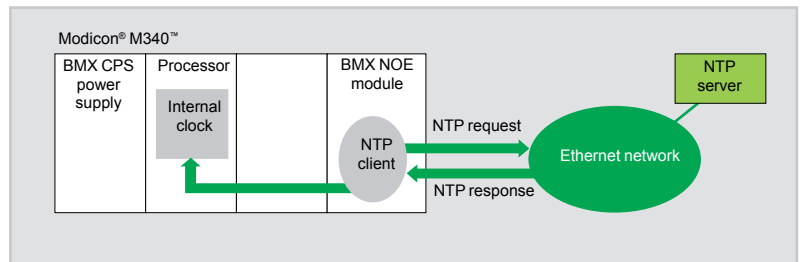

The time synchronization service is based on the NTP (*Network Time Protocol*) that is used to synchronize the time of a client or a server on Ethernet from a server or another reference time source (radio, satellite, etc).

Operation

BMX NOE 0100/0110 Ethernet communication modules have an NTP client component. These modules can connect to an NTP server using a client request (*Unicast*) to update their local time. The module clock is updated periodically (1 to 120 s) with a precision of 5 ms for processors. If the NTP server cannot be reached, the Ethernet module switches to a standby NTP server.

The Modicon M340 processor clock is updated with a precision of 5 ms. A function block is available for reading this clock. In each Unity Pro application, events or variables can be time-stamped.

The Ethernet module is configured via a Web page. The time zone can be configured. A time synchronization service (NTP) diagnostic Web page is also available.

Information on the time synchronization service (NTP) is also available in the Transparent Ready® private MIB that can be accessed via the SNMP network management service.

Functions (continued)

Global Data service

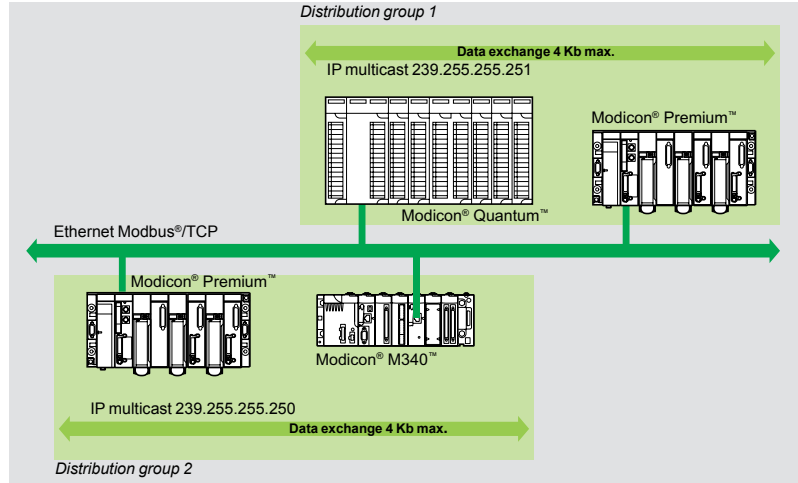

The Global Data service exchanges data in real time between stations belonging to the same distribution group. It is used to synchronize remote applications, or even to share a common database between a number of distributed applications. Exchanges are based on a producer/consumer type standard protocol, helping to guarantee optimum performances with a minimum load on the network. This RTPS (Real Time Publisher Subscriber) protocol is promoted by Modbus-IDA (Interface for Distributed Automation), and is already a standard adopted by several manufacturers.

Specifications

A maximum of 64 stations can participate in Global Data within a single distribution group.

Each station can:

- Publish 1 variable of 1024 bytes. The publication period can be configured from 1 to n processor master task (*Mast*) periods.
- Subscribe between 1 and 64 variables. The validity of each variable is controlled by status bits (*Health Status bits*) linked to a refresh timeout configurable between 50 ms and 1 s. Access to an element of the variable is not possible. The total size of subscribed variables amounts to 4 contiguous Kbytes.

To further optimize the performance of the Ethernet network, Global Data can be configured with the "multicast filtering" option enabled. This, when combined with switches in the ConneXium™ range, will distribute data only to Ethernet ports where there is a station subscribed to the Global Data service. If these switches are not used, Global Data is sent in "multicast" mode to each switch port.

Global Data service diagnostics

The diagnostic screens show the status of Global Data using a color code:

- Configured/not configured/detected fault
- Published/subscribed

There are 5 ways to perform diagnostics on the Global Data service:

- Via the application program from a specific PLC data zone.
- From the setup software debug screen.
- From the PLC system diagnostic function displayed by means of an internet browser on a PC station.
- From the ConneXium diagnostic software **TCS EAZ 01P SFE10**.
- From the standard SNMP manager software.

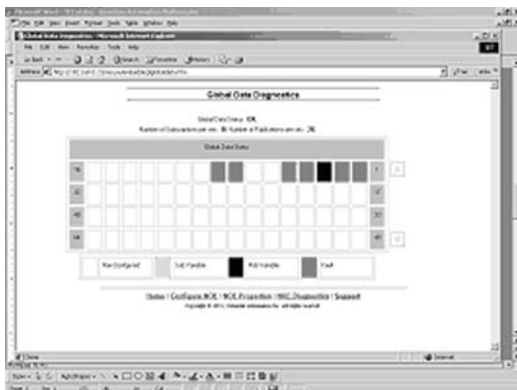

Modicon® M340™ automation platform

Ethernet Modbus®/TCP network
Ethernet Modbus/TCP communication services

Functions (continued)

SNMP network management service

From a network management station, the SNMP (Simple Network Management Protocol) protocol monitors and checks components of the Ethernet architecture and thus helps ensure quick diagnostics in the event of a problem.

It is used to:

- Interrogate network components such as computer stations, routers, switches, bridges or terminal devices to display their status.
- Obtain statistics about the network.

This network management software adheres to the conventional client/server model. However, to avoid confusion with other communication protocols that use this terminology, we talk instead about:

- ConneXview network diagnostics software, **TCS EAZ 01P SFE10**. For more information, please consult our "Machines & Installations with industrial communications" catalog.
- Network manager for the client application that operates on the computer station.
- SNMP agent for the network device server application

Transparent Ready® devices can be managed by any SNMP network manager, including HP Openview and IBM Netview.

The SNMP standard protocol is used to access the configuration and management objects that are contained in the device Management Information Base (MIB). MIBs must comply with certain standards to be accessed. Depending on the complexity of the products, manufacturers can add objects to customize databases.

The Transparent Ready private MIB presents management objects specific to the Schneider Electric offer. These objects simplify the installation, setup and maintenance of Transparent Ready devices in an open environment using standard network management tools.

Transparent Ready devices support 2 levels of SNMP network management:

- The Standard MIB II interface: An initial level of network management is accessible via this interface. It enables the manager to identify the devices making up the architecture and retrieve general information on the configuration and operation of Ethernet Modbus®/TCP interfaces.
- The Transparent Ready MIB interface: The management of Transparent Ready devices is improved via this interface. This MIB has a set of information enabling the network management system to supervise the Transparent Ready services. The Transparent Ready MIB can be downloaded from the FTP server of any Transparent Ready Ethernet module in a PLC.

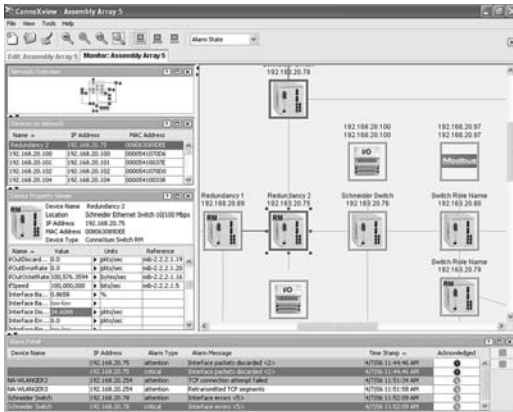

Automatic recognition of IP devices via the ConneXview diagnostic software for Ethernet industrial networks



Selecting the communication architecture

When choosing an architecture, make certain to determine the system requirements. The developer must:

- 1 Know exactly what he needs:
 - quantity and type of devices to be connected to one another
 - volume and type of exchanges
 - expected response times
 - environment
- 2 Compare his needs with the specifications of the available offers—being aware that the actual performance level between any 2 points in an architecture is dependent on the weakest link in the chain which could depend on:
 - hardware
 - the application's size, architecture, operating system, machine power rating and other parameters. These parameters are often vaguely defined at this stage of the project.
- 3 Determine from this information the most suitable architecture.

The next few pages will provide information and instructions to determine the user's network performance needs. Given that the performance of an Ethernet architecture is linked to several parameters, some of the information required to calculate the network performance will not be supplied on these pages. The following will be covered:

- **Instructions for calculating the network load** so as to design an Ethernet network that meets the demands of the applications.
- **Application response time** to be obtained depending on the configuration used. See page 3/17 to 3/19
- **Processing capacities of Modicon® M340™, Modicon® Premium™ and Modicon® Quantum™ platforms** used to select the processor and define the number of Ethernet connections required on the PLC depending on the application. See pages 3/20 and 3/21.

Calculating the network load

Introduction

When calculating the load on an Ethernet network, the communication services of the peripheral devices connected to the network need to be calculated. Because of the outstanding performance of the Ethernet network, the load is often less than the limits of the Ethernet network and does not affect the application response time. This is explained by the high speed of the Ethernet network: the network transaction time is 10% less than the application response time. To help ensure a low network load and avoid large theoretical calculations, it is highly advisable to separate the collision domain to limit the network load, using only the switched network (tree, star or daisy-chain topology).

Modicon® M340™ automation platform

Ethernet Modbus®/TCP network Performance

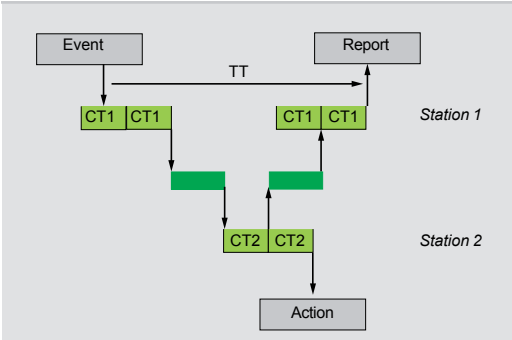

Application response time

Modbus® (or Uni-TE™) messaging service response time

Exchanges between the PLC processor and the Ethernet module are synchronous with the PLC scan time (CT), just like the I/O exchanges. On occurrence of the event (for example, an input set to state 1), a message can only be sent after this input has been taken into account (start of the next cycle) and execution of the PLC program (Modicon® M340™, Modicon® Premium™ or Modicon® Quantum™), are on average around 1.5 cycle times after occurrence of the event.

The network access time (NAT) appearing in the table below in ms, adds together the module transit time and the waiting time before the message can be sent on the network.

Processing Modbus/TCP message requests	Modicon M340		Modicon Premium		Modicon Quantum	
		BMX NOE 0100 BMX NOE 0110	BMX P34 2020 BMX P34 2030	TSX ETY 210 TSX ETY 110WS	TSX ETY 4103/5103 TSX WMY 100 TSX P57 10...57 60	140 NOE 771 01/111 140 CPU 113/311 ●● 140 CPU 434/534 1●
Network access time NAT	< 10 ms	< 10 ms	< 25 ms	< 10 ms	< 10 ms	< 10 ms



The transaction time TT integrates the delay between sending a message from a client station 1, its reception by the server station 2, processing the request, sending the response and it being taken into account by the station 1 (for example, updating an output).

As shown in the above block diagram:

- The transaction time TT should be between:

$$2 \times CT1 + 2 \times NAT < TT < 4 \times CT1 + CT2 + 2 \times NAT$$

- The average duration TT_{av} is equivalent to:

$$TT_{av} = 3 \times CT1 + 0.5 \times CT2 + 2 \times NAT$$

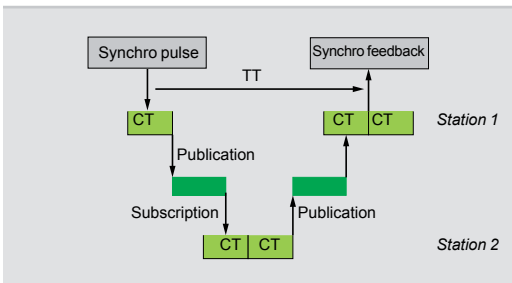

Global Data service response time

The transaction time TT integrates the delay between publication of a Global Data service by station 1, its reception and its processing by the remote station 2 and it being resent to the initial station 1:

For an exchanged variable:

- If $CT < 5$ ms, transaction time:

$$TT = 5 \text{ to } 6 \times CT$$

- If $CT \geq 10$ ms, transaction time:

$$TT = 3 \times CT$$

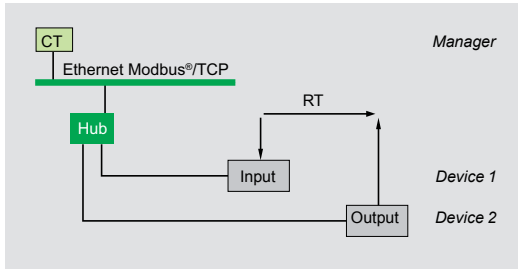

Application response time (continued)

I/O Scanning service response time

The response time RT includes the time between taking a remote input into account and updating the state of a remote output. It includes the processing time in the PLC.

This response time RT consists of the following parameters:

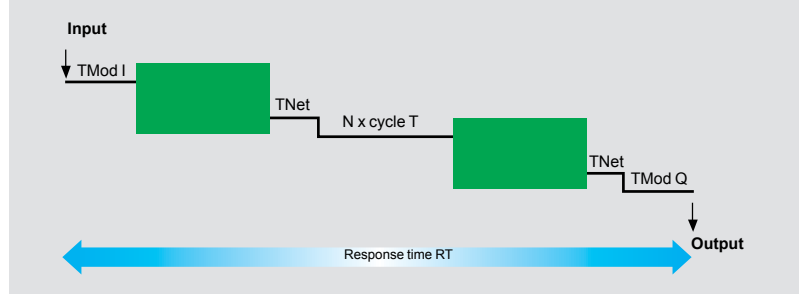

- TMod In and TMod Out: Response time of the read/written device, excluding the electrical transit time at the input/output (TMod depends on the device, usually between 1 and 8 ms)
- TIOS In and TIOS Out: Time between 2 read/write operations on the same device (0.3 ms x number of scanned devices), at least equivalent to the configured scan time
- As TIOS is executed in parallel with the PLC scan, it can be hidden with respect to the response time RT).
- Cycle T: PLC scan time.
- TNet : propagation time on the network (depends on the application, usually TNet = 0.05 ms at 10 Mbit/s and 0.005 ms at 100 Mbit/s).

The response time RT can be estimated with the following 3 formulas:

- **RT_{min}**: minimum response time with TIOS hidden and 1 PLC scan:

$$RT_{min} = (TMod In + 0) \times TIOS In + (Tnet + N) \times cycle T + (0 \times TIOS Out) + Tnet + TMod Out$$
- **RT_{typ}**: typical response time with 0.5 TIOS hidden:

$$RT_{typ} = (TMod In + 0,5) \times TIOS In + (Tnet + N) \times Cycle T + (0,5 \times TIOS Out) + Tnet + TMod Out$$
- **RT_{max}**: maximum response time with TIOS not hidden:

$$RT_{max} = TMod In + TIOS In + (Tnet + N) \times Cycle T + TIOS Out + Tnet + TMod Out$$

Modicon® M340™ automation platform

Ethernet Modbus®/TCP network Performance

Application response time (continued)

I/O Scanning service response time (continued)

Below are the TMod In and TMod Out response times:

Type of distributed I/O	Response time	Values		
		Min.	Typical	Max.
Momentum™ 170 ENT 110 02	TMod In	1 ms	1 ms	1 ms
	TMod Out	5 ms	5 ms	5 ms
Momentum 170 ENT 110 01	TMod In	4 ms	6 ms	8 ms
	TMod Out	4 ms	6 ms	8 ms
Modicon® STB STB NIP 2212	TMod In	2 ms	3 ms	4 ms
	TMod Out	2 ms	3 ms	4 ms

Below are the TIOS In/TIOS Out times measured between 2 scan cycles (Ethernet network with switches)

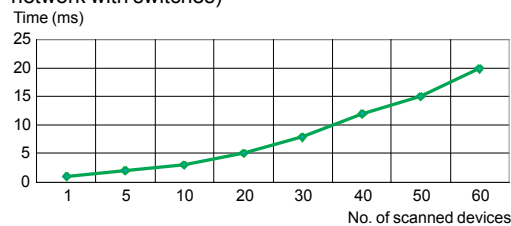

Below is the number of processor cycles N:

Type of Ethernet module or processor	No. of processor cycles N		
	Min.	Typical	Max.
Modicon® M340™ platform with Ethernet modules: BMX NOE 0100 and BMX NOE 0110	2	2.5	3
Modicon® Premium™ platform with Ethernet modules: TSX ETY 4103 and TSX ETY 5103			
Modicon® Quantum™ platform with Ethernet modules: 140 NOE 771 01 and 140 NOE 771 11			
Modicon M340 processors: BMX P34 2020 and BMX P34 2030			
Modicon Premium processors: TSX P57 26/3634M , TSX P57 26/2823M and TSX P57 36/4823AM	1	1	2
Modicon Premium processors: TSX P57 4634M/5634M/6634M			
Modicon Quantum processors: 140 CPU 651 50 and 140 CPU 651 60			



Modicon® M340™ automation platform

Ethernet Modbus®/TCP network Performance

Processing capacities of Modicon® platforms

Processing capacity

Use the table below to compare for each station, the total number of messages received on the Modbus® (or Uni-TE™) messaging service if used (value R1, R2 or Ri) with the station processor capacity.

Processing Modbus requests for each PLC scan

Modicon® M340™, Modicon® Premium™/Atrium™ platforms	Messages received
Total messages received by the PLC from each communication modules (1)	TSX 57 10 4 messages/cycle
	BMX P34 20/TSX 57 20 8 messages/cycle
	TSX 57 30 12 messages/cycle
	TSX 57 40 16 messages/cycle
	TSX 57 50/60 (2) 16/20 messages/cycle

Modicon® Quantum™ platform	Limitations of the integrated port		Limitations of the communication modules		Ethernet modules per PLC
	All types of communication request	Additional read/write 4x registers	All types of communication request	Additional read/write 4x registers	
140 CPU 113 (3)	–	–	1 message/cycle	4 messages/cycle	max. 2
140 CPU 311	–	–	1 message/cycle	4 messages/cycle	max. 2
140 CPU 434/534	–	–	4 messages/cycle	8 messages/cycle	max. 6
140 CPU 651	16 messages/cycle	16 messages/cycle	4 messages/cycle	8 messages/cycle	max. 6

messages/cycle: number of messages received per cycle from the PLC master task (typical cycle of 50 to 100 ms)

Example:

- Quantum 140 CPU 434 12● processor with 4 Ethernet 140 NOE 771 ●1 modules:
- 20 messages/cycle for all types of communication request, and
- 32 messages/cycle for the read/write 4x registers

Ethernet transaction processing capacity

Compare for each station the total number of messages received Σ [values Ri, Rj] and the total number of messages sent Σ [values Ei, Ej] (for example, for station N) with the Ethernet transaction processing capacity indicated below. Use the elements below for the Ethernet connection per PLC, rather than the number of transactions required by the application.

Ethernet transaction processing capacity	Modicon M340		Modicon Premium			Modicon Quantum	
	BMX NOE 0100 BMX NOE 0110	BMX P34 2020 BMX P34 2030	TSX ETY 210 TSX ETY 110WS	TSX ETY 4103/5103 TSX WMY 100 TSX P57 10/20/30/40	TSX P57 50 TSX P57 60	140 NOE 771 01 140 NOE 771 11 140 NWM 100 00	140 CPU 65 150 140 CPU 65 160 140 CPU 67 160
Modbus messaging	500 transactions/s	500 transactions/s	60 transactions/s	450 transactions/s	500 transactions/s	350 transactions/s	350 transactions/s
I/O Scanning service	2,000 transactions/s	Server mode (4)	Service not available	2,000 transactions/s (5)	2,000 transactions/s	2,000 transactions/s (5)	2,000 transactions/s
Subscription of Global Data	800	Service not available	Service not available	800	800	800	800

(1) A temporary overload, due for example to an adjustment terminal or the temporary connection of an Internet browser, on which a few PLC scans are permitted.

(2) Only with Unity™ Pro software.

(3) Only with Concept™/ProWORX™ software.

(4) BMX P34 20●0 processors having the Modbus®/TCP messaging in server mode can be scanned by a product having the I/O Scanning service.

(5) Modules TSX WMY 100 and 140 NWM 100 00: not featuring I/O Scanning and Global Data services.

Modicon® M340™ automation platform

Ethernet Modbus®/TCP network Performance

Processing capacities of Modicon® platforms (continued)

Maximum number of simultaneous Modbus®/TCP connections

The maximum number of simultaneous Modbus/TCP connections depends on the platform as well as the type of connection to the Ethernet network:

- The 10/100BASE-TX port in network modules.
- The 10/100BASE-TX port integrated in processors.

Number of simultaneous Modbus/TCP connections	Modicon® M340™		Modicon® Premium™		Modicon® Quantum™	
	BMX NOE 0100 BMX NOE 0110	BMX P34 2020 BMX P34 2030	TSX ETY 210 TSX ETY 110WS	TSX ETY 4103/5103 TSX WMY 100 TSX P57 10...57 60	140 NOE 771 01/11 140 CPU 113/311 ●● 140 CPU 434/534 14B	140 CPU 65 150 140 CPU 65 160
Client	16	16	32	16 (1)	16 (1)	16 (1)
Server	16	16		64 (1)	64 (1)	64 (1)

(1) With 64 simultaneous Modbus/TCP connections maximum (clients and servers).

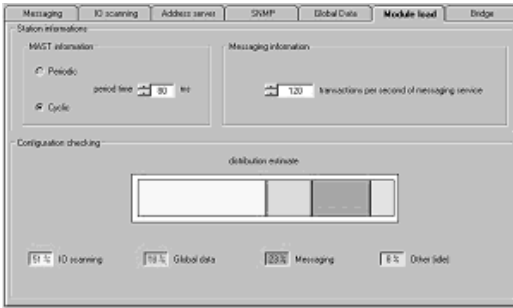

Managing the passband of Ethernet Modbus/TCP modules

The passband management service indicates the load level of the Ethernet network module. This allows the user to monitor any drift and anticipate any problems.

The Ethernet module load is indicated in 3 ways:

- Expected load in the Unity™ Pro/PL7 configuration screen.
- Actual load in the Unity Pro/PL7 diagnostics/debug screen, as well as in the diagnostics pages via the Web. It is displayed in the form of a bar chart animated in real time.
- In the SNMP interface for access by the SNMP network manager.



The passband is indicated as a percentage for each of the following services:

- Modbus (and Uni-TE) messaging
- I/O Scanning
- Global Data
- Other



Ethernet port integrated in processor, example with the BMX P34 2020/2030 Modicon M340

or

Ethernet dedicated module, example with the BMX NOE 0100/0110 Modicon M340

Ethernet solutions with the Modicon® platforms

The Modicon PLC has 2 types of connections to the Ethernet network:

- The 10/100BASE-TX port integrated in processor modules exchanges with other modules supported by the rack and other communication ports (CANopen bus, Modbus serial link, ...).
- The 10/100BASE-TX port in the dedicated network module where the resources are only allocated to Ethernet Modbus/TCP communication.

These fundamentally different hardware specifications result in equally different capacities in terms of services and performance:

- The integrated port is a low-cost way of satisfying applications that are not too demanding in terms of communication (≤ 500 useful messages/s) in environments seldom affected by interference.
- Where there are a large number of exchanges, or networks are heavily polluted, use of a dedicated module is unavoidable.

Modicon® M340™ automation platform

Processors with integrated Modbus®/TCP Ethernet port

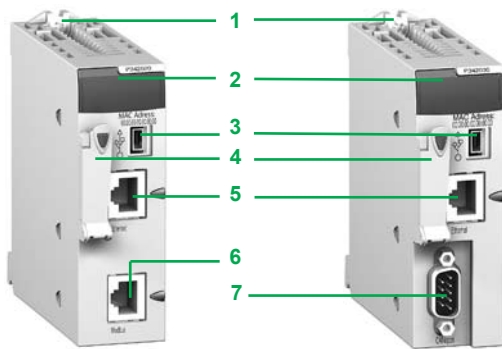

3

Description

BMX P34 2020 and **BMX P34 2030** Modicon® M340™ processors with integrated Ethernet port have the following on the front panel:

- 1 Screw for securing the module in its slot (marked 0) in the rack
- 2 A display unit including at minimum 3 LEDs relating to the Ethernet port:
 - ETH ACT LED (green): Activity on the Ethernet network
 - ETH STS LED (green): Ethernet TCP/IP network status
 - ETH 100 LED (red): Data rate on the Ethernet network (10 or 100 Mbit/s)
- 3 A mini B USB connector for a programming terminal (or Magelis XBT GT/GK/GTW operator interface)
- 4 A slot equipped with its Flash memory card for saving the application and activating the standard web server, Transparent Ready® class B10.
- 5 An RJ45 connector for connection to the 10BASE-T/100BASE-TX Ethernet network

Also included, depending on the model:

- 6 **BMX P34 2020** processor: An RJ45 connector for the Modbus® serial link or character mode link (RS 232C/RS 485, 2-wire, non-isolated)
- 7 **BMX P34 2030** processor: A 9-way SUB-D connector for the master CANopen machine and installation bus

On the back panel: 2 rotary switches for assigning the IP address in one of 3 modes:

- address set by the position of the two switches
- address set by the application parameters
- address set by the Ethernet BOOTP server

Specifications

Module type		BMX P34 2020	BMX P34 2030	
Transparent Ready services	Class	B10		
	Standard web server	Rack Viewer access to the product description and status and to the PLC diagnostics Data Editor access to the configuration functions and PLC variables		
	Ethernet Modbus®/TCP basic communication service	Modbus/TCP messaging (read/write data words)		
	Ethernet I/O Scanning	-		
	Modbus/TCP Global Data	-		
	advanced NTP time synchronization	-		
	communication FDR Client	Automatic assignment of IP address and network parameters		
	services SMTP E-mail notification	Yes, via EF function block (SEND_EMAIL) of Unity Pro ≥ 4.0		
Structure	Physical interface	10BASE-T/100BASE-TX (RJ45)		
	Data rate	10/100 Mbit/s with automatic recognition		
	Medium	Twisted pair		
	Modicon M340 processor	No. of discrete I/O	1024	
		No. of analog I/O	256	
		No. of application-specific channels	36	
		Max. no. of Ethernet Modbus/TCP connections	3 (integrated port and 2 BMX NOE 0100/0110 network modules)	
	Other integrated communication ports	Modbus serial link or character mode	CANopen bus	
Operating temperature	0...+ 60°C			
Relative humidity	10...95% non condensing during operation			
Degree of protection	IP 20			
Power supply	Via the power supply of the rack supporting the processor			
Conformity to standards	IEC/EN 61131-2, UL 508, CSA 22.2 n°142, CSA 22.2 n°213 Class 1 Division 2, CE			
LED indicators	Activity on the Ethernet TCP/IP network (ETH ACT, green) Status of the Ethernet TCP/IP network (ETH STS, green) Data rate on the 10 or 100 Mbit/s Ethernet TCP/IP network, (ETH 100, red) 4 LEDs specific to processor operation (RUN, ERR, I/O, CARD ERR) 1 or 2 LEDs specific to the other communication ports (1)			

References



BMX P34 2020

BMX P34 2030

Description	I/O capacity	Other integrated communication ports	Reference	Weight kg
Processors with integrated Ethernet link	1024 discrete I/O	Modbus® serial link or character mode	BMX P34 2020	0.205
	256 analog I/O	CANopen bus	BMX P34 2030	0.215
Transparent Ready® class B10	4096 Kb integrated			

(1) SER COM LED for serial link or CAN RUN and CAN ERR LEDs for CANopen bus.

Modicon® M340™ automation platform

Ethernet Modbus®/TCP network modules

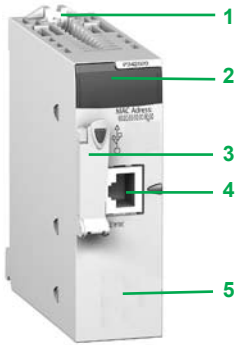

Introduction

The **BMX NOE 0100** and **BMX NOE 0110** modules are a standard module occupying a single slot in the rack of the Modicon® M340™ platform equipped with a Standard or Performance processor.

Description

The **BMX NOE 0100/NOE 0110** modules has the following on the front panel:

- 1 Screw for securing the module in its slot in the rack
 - 2 A display unit consisting of 6 LEDs, including 3 relating to the Ethernet port:
 - ETH ACT LED (green): Activity on the Ethernet network
 - ETH STS LED (green): Ethernet network status
 - ETH 100 LED (red): Data rate on the Ethernet network (10 or 100 Mbit/s)
 - 3 A slot equipped with a Flash memory card for application saving and activating the standard web server, Transparent Ready® class B30 or C30 depending on model
 - 4 An RJ45 connector for connection to the 10BASE-T/100BASE-TX Ethernet network
 - 5 A pencil-point RESET pushbutton for a cold restart of the module
- On the back panel: 2 rotary switches for assigning the IP address in one of 3 modes:
- address set by the position of the two switches
 - address set by the application parameters
 - address set by the Ethernet network BOOTP server.



Specifications

Module type		BMX NOE 0100	BMX NOE 0110
Transparent Class Ready services	Standard web server	B30	C30
	Configurable web server	Rack Viewer access to the product description and status and to the PLC diagnostics	
	User Web pages (available size)	Data Editor access to PLC variable via PC terminal	Data Editor access to PLC variable via PC terminal, pocket PC or PDA terminal
	Ethernet Modbus®/TCP communication service	–	Alarm viewer Graphic Data Editor
	Ethernet Modbus/TCP advanced communication services	–	User Web page hosting and display (14 Mb)
	I/O Scanning	Modbus/TCP messaging (read/write data words)	
	Global Data	Yes	
	NTP time synchronization	Yes, with version module ≥ 2.0	
	FDR server	Automatic assignment of IP address and network parameters	
	SMTPE-mail notification	–	
SOAP/XML Web services	–	Server	
SNMP network administrator	Yes		
Bandwidth management	Yes		
Structure	Physical interface	10BASE-T/100BASE-TX (RJ45)	
	Data rate	10/100 Mbit/s with automatic recognition	
	Medium	Twisted pair	
Ethernet module	No. of Ethernet modules per configuration	Max. 1 with BMX P34 1000 processor, max. 2 with BMX P34 2000 processor	
	Operating temperature	0...+ 60°C	
	Relative humidity	10...95% non condensing during operation	
	Degree of protection	IP 20	
	Power supply	Via the power supply of the rack supporting the processor	
	Conformity to standards	IEC/EN 61131-2, UL 508, CSA 22.2 n°142, CSA 22.2 n°213 Class 1 Division 2, CE	
	LED indicators	Activity on the Ethernet TCP/IP network (ETH ACT, green) State of the Ethernet TCP/IP network (ETH STS, green) Data rate on the 10 or 100 Mbit/s Ethernet TCP/IP network, (ETH 100, red) 3 LEDs specific to module operation (RUN, ERR, CARD ERR)	

References



Description	Data rate	Transparent Ready® class	Reference	Weight kg
Ethernet Modbus®/TCP network module	10/100 Mbit/s	B30	BMX NOE 0100	0.200
		C30	BMX NOE 0110	0.200

Replacement parts

Description	Size	Supplied as standard with	Reference	Weight kg
Flash memory cards	8 Mb	BMX NOE 0100	BMX RWS B000M	0.002
	32 Mb	BMX NOE 0110	BMX RWS FC032M	0.002

Modicon® M340™ automation platform

Ethernet network
Infrastructure

Introduction

Schneider Electric offers copper and fiber optic cables for connecting IP 20 and IP 67 Ethernet devices.

Examples

Mixed IP 20 and IP 67 wiring (copper)

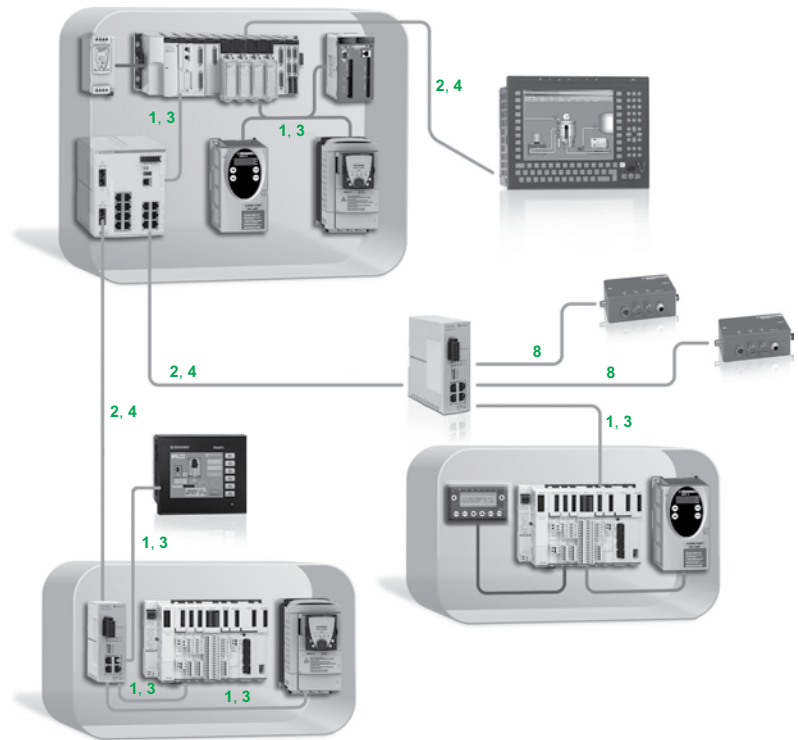

Key:

1, 3: Straight-through copper cables

2, 4: Crossed copper cables

8: Cables with IP 67 connector

See pages 3/26 and 3/27.

Examples (continued)

Mixed copper and fiber optic wiring

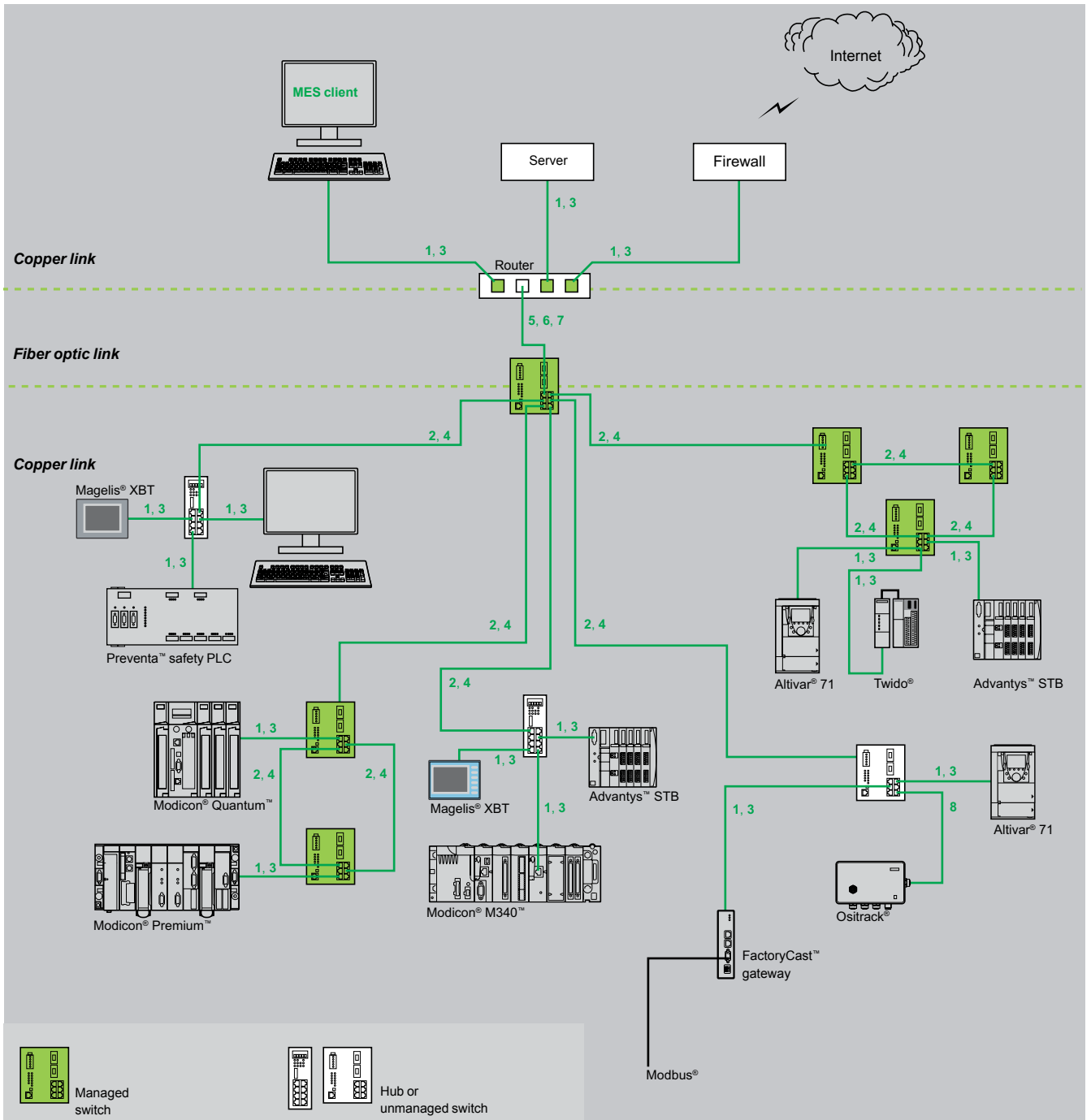

Key:
 1, 3: Straight cables
 2, 4: Crossed cord cables
 5, 6, 7: Fiber optic cables
 8: Cables with IP 67 connector
 See pages 3/26 and 3/27.

Modicon® M340™ automation platform

Ethernet network

Cabling system

ConneXium™ connection components

3



490 NT● 000 ●●

Shielded copper connection cables

ConneXium™ shielded connection cables are available in two versions to meet the various current standards and approvals:

■ EIA/TIA 568 shielded twisted pair cables for C€ market

These cables conform to:

- EIA/TIA-568, category CAT 5E
- IEC 11801/EN 50173-1, class D

Their fire resistance conforms to:

- NF C32-070, class C2
- IEC 322/1
- Low Smoke Zero Halogen (LSZH)

■ EIA/TIA 568 shielded twisted pair cables for UL market

The cable material is:

- CEC type FT-1
- NEC type CM

EIA/TIA 568 shielded twisted pair cables for C€ market

Description	Preformed at both ends	Rep.	Length m (ft)	Reference	Weight kg
Straight cables	2 RJ45 connectors For connection to terminal devices (DTE)	1	2 (6.6)	490 NTW 000 02	—
			5 (16.4)	490 NTW 000 05	—
			12 (39.4)	490 NTW 000 12	—
			40 (131.2)	490 NTW 000 40	—
			80 (262.5)	490 NTW 000 80	—
Crossed cord cables	2 RJ45 connectors For connections between hubs, switches and transceivers	2	5 (16.4)	490 NTC 000 05	—
			15 (49.2)	490 NTC 000 15	—
			40 (131.2)	490 NTC 000 40	—
			80 (262.5)	490 NTC 000 80	—

EIA/TIA 568 shielded twisted pair cables for UL market

Description	Preformed at both ends	Rep.	Length m (ft)	Reference	Weight kg
Straight cables	2 RJ45 connectors For connection to terminal devices (DTE)	3	2 (6.6)	490 NTW 000 02U	—
			5 (16.4)	490 NTW 000 05U	—
			12 (39.4)	490 NTW 000 12U	—
			40 (131.2)	490 NTW 000 40U	—
			80 (262.5)	490 NTW 000 80U	—
Crossed cord cables	2 RJ45 connectors For connections between hubs, switches and transceivers	4	5 (16.4)	490 NTC 000 05U	—
			40 (131.2)	490 NTC 000 40U	—
			80 (262.5)	490 NTC 000 80U	—

“Do it Yourself” cable and connectors

The “Do It Yourself” offer is comprised of 2 references for “field installable” connectors (M12 and RJ45) and one reference for spooled cable measuring 300 m. These products are intended for use in industrial Ethernet networks supporting transmission rates up to 100 Mbit/s over the combined maximum cable length up to 80 m.

Quick on the floor assembly with only a knife and pliers.

Description	According to	Length m (ft)	Reference	Weight kg
Ethernet copper cable 2 shielded twisted pairs 24 AWG	EIA/TIA-568 (80 m max. link length) UL 508-CM, e EN 50173 Class D	300 m (1000)	TCS ECN 300R2	—
RJ45 connector IP 20	EIA/TIA-568-D, category CAT 5E, C€	—	TCS EK3 MDS	—
M12 connector D-Code, IP 65/67	IEC 60176-2-101, EN 50173 Class D	—	TCS EK1 MDRS	—

(1) For Key to reference numbers, see pages 3/24 and 3/25.

Modicon® M340™ automation platform

Ethernet network
Cabling system

ConneXium™ connection components

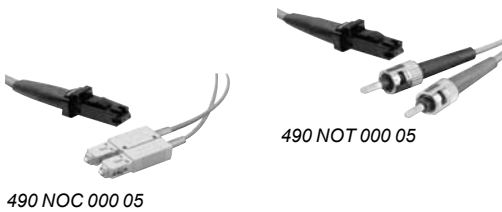

490 NOC 000 05



490 NOT 000 05



490 NOR 000 05



TCS EAA F1LF● 00

Glass fiber optic cables

These glass optical fibers are for making connections to:

- Terminal device (DTE)
- Between hubs, transceivers and switches

Description	Preformed at both ends	Rep.	Length m (ft)	Reference	Weight kg
Glass fiber optic cables	1 SC connector 1 MT-RJ connector	5	5 (16.4)	490 NOC 000 05	–
	1 ST (BFOC) connector 1 MT-RJ connector	6	5 (16.4)	490 NOT 000 05	–
	2 MT-RJ connectors	7	3 (9.8)	490 NOR 000 03	–
			5 (16.4)	490 NOR 000 05	–

Separate parts for TCS ESM switches

Description	Optical fiber	Type	Reference	Weight kg
Fiber optic modules for Gigabit ports with LC connector (1)	Multimode 50/125 μm or 62.5/125 μm	1000BASE-SX	TCS EAA F1LFU00	0.040
	Single mode 9/125 μm	1000BASE-LH	TCS EAA F1LFH00	0.040
	Multimode 50/125 μm or 62.5/125 μm Single mode 62.5/125 μm	1000BASE-LX	TCS EAA F1LFS00	0.040
Configuration backup key	Via the USB port on the front of the switch, used to: - Save and retrieve the switch configuration - Update the internal software		TCS EAM 0100	–

(1) Dimensions W x H x D = 20 x 18 x 50 mm

Connection components for IP 67 switch

Description	Preformed at both ends	Rep.	Length m (ft)	Reference	Weight kg
Copper cables	1 IP 67 4-way M12 connector and 1 RJ45 connector	8	1 (3.3)	TCS ECL 1M3M 1S2	–
			3 (9.8)	TCS ECL 1M3M 3S2	–
			10 (32.8)	TCS ECL 1M3M 10S2	–
			25 (82)	TCS ECL 1M3M 25S2	–
			40 (131.2)	TCS ECL 1M3M 40S2	–
	2 IP 67 4-way M12 connectors	–	1 (3.3)	TCS ECL 1M1M 1S2	–
			3 (9.8)	TCS ECL 1M1M 3S2	–
			10 (32.8)	TCS ECL 1M1M 10S2	–
			25 (82)	TCS ECL 1M1M 25S2	–
			40 (131.2)	TCS ECL 1M1M 40S2	–
Power cables	Female M12 straight connector	–	2 (6.6)	XZC P1164L2	–
			5 (16.4)	XZC P1164L5	–
	Female M12 elbowed connector	–	2.5 (8.2)	XZC P1264L2	–
			5 (16.4)	XZC P1264L5	–
Power connectors	Female M12 straight connector	–	–	XZC C12 FDM 50B	–
	Female M12 elbowed connector	–	–	XZC C12 FCM 50B	–
M12/RJ45 adaptor	IP 67 female 4-way M12 connector and female RJ45 connector	–	–	TCS EAA F11F13F00	–

Modicon® M340™ automation platform

Ethernet network
Cabling system
ConneXium™ hub

Introduction

Hubs (concentrators) are used for transmitting signals between several media (ports). Hubs are “plug and play” devices that do not need any configuration. The use of hubs makes it possible to create the following topologies:

- Star topology using hubs
- Tree topology using hubs

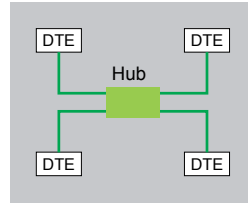

Star topology

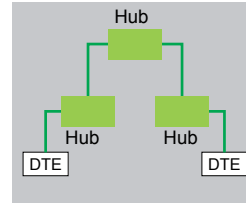

Tree topology

3

Specifications and reference



Hubs			
Interfaces	Copper cable ports	Number and type	4 x 10BASE-T ports
		Shielded connectors	RJ45
		Medium	Shielded twisted pair, category CAT 5E
		Total length of pair	100 m
Fiber optic ports	Number and type	-	
Topology	Number of cascaded hubs	Up to 4	
	Number of hubs in a ring	-	
Redundancy	P1 and P2 redundant power supplies		
Power supply	Voltage	24 V ~ (18...32), safety extra low voltage (SELV per IEC 61140)	
	Consumption	80 mA (130 max. at 24 V ~)	
	Removable terminal block	5-way	
Operating temperature	0...+60°C		
Relative humidity	10...95% non-condensing		
Degree of protection	IP 30		
Dimensions	W x H x D	40 x 125 x 80 mm	
Mounting	On symmetrical DIN rail, 35 mm wide		
Weight	0.530 kg		
Conforming to standards	cUL 60950, UL 508 and CSA 22.2 No. 142, UL 1604 and CSA 22.2 No. 213 Class 1 Division 2, C€, GL, C-Tick FM 3810, FM 3611 Class 1 Division 2		
LED indicators	Power supply, activity, link		
Alarm relay	Power supply detected fault, Ethernet network detected fault or communication port detected fault (volt-free contact 1 A max. at 24 V ~)		

Modicon® M340™ automation platform

Ethernet network

Cabling system

ConneXium™ transceiver

Introduction

The use of ConneXium™ transceivers makes it possible to perform the following:

- Creation of linear fiber optic bus topologies for products with twisted pair cable Ethernet connection
- Interfacing products with twisted pair cable Ethernet connection with a fiber optic cable

Transceivers are “plug and play” devices that do not need any configuration.

ConneXium transceivers provide fiber optic connections for transmission in areas subject to interference (high levels of electromagnetic interference) and for long distance communications.

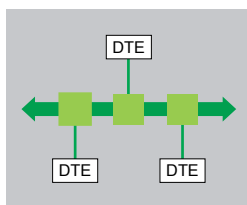

Linear topology on optical fiber

Specifications and reference

Transparent
Ready.



Transceivers			
Interfaces	Copper cable ports	Number and type	1 x 100BASE-TX port
		Shielded connectors	RJ45
		Medium	Shielded twisted pair, category CAT 5E
		Total length of pair	100 m
	Fiber optic ports	Number and type	1 x 100BASE-FX port
		Connectors	SC
		Medium	Multimode optical fiber
		Length of optical fiber	
		50/125 µm fiber	3000 m (1)
		62.2/125 µm fiber	3000 m (1)
Attenuation analysis			
	50/125 µm fiber	8 dB	
	62.2/125 µm fiber	11 dB	
Redundancy			P1 and P2 redundant power supplies
Power supply	Voltage		24 V $\overline{\text{---}}$ (18...32), safety extra low voltage (SELV per IEC 61140)
	Consumption		160 mA (190 max. at 24 V $\overline{\text{---}}$)
	Removable terminal block		5-way
Operating temperature			0...+60°C
Relative humidity			10...95% non-condensing
Degree of protection			IP 20
Dimensions		W x H x D	47 x 135 x 111 mm
Mounting			On symmetrical DIN rail, 35 mm wide
Weight			0.230 kg
Conforming to standards			cUL 60950, UL 508 and CSA 22.2 No. 142, UL 1604 and CSA 22.2 No. 213 Class 1 Division 2, CE, GL, C-Tick
LED indicators			P1 and P2 power supplies, Ethernet link/port status
Alarm relay			Power supply detected fault, Ethernet network detected fault or communication port detected fault (volt-free contact 1 A max. at 24 V $\overline{\text{---}}$)

(1) Length is dependent on the attenuation analysis and attenuation of the optical fiber (typical value: 2000 m).

Modicon® M340™ automation platform

Ethernet network
Cabling system

ConneXium™ unmanaged switches

Introduction

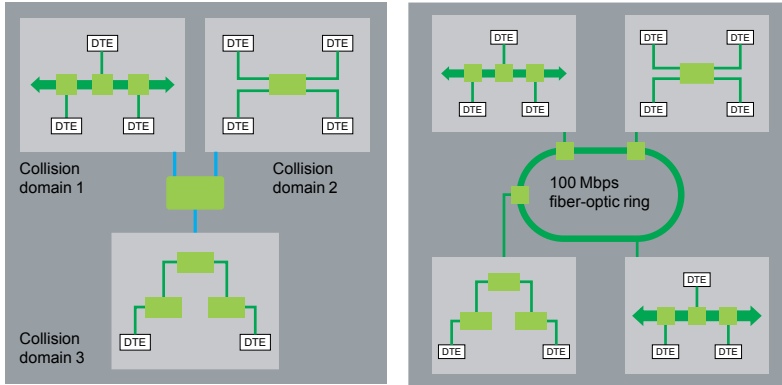

Switches are used to increase the limits of architectures based on hubs or transceivers by separating collision domains. Higher layer communication is provided between the ports and collisions at link layer are not propagated (filtering). The performance is improved by better allocation of the pass band due to the reduction of collisions and the network load. Certain ConneXium™ switch models enable redundant architectures to be created on twisted pair copper ring or fiber optic. Switches are “plug & play” devices that do not need any configuration. They can also be managed remotely via the SNMP or HTTP protocols for monitoring and diagnostics purposes.

3

Specifications and references: Twisted pair

Transparent Ready.



Switches		Copper twisted pair, unmanaged				
Interfaces	Copper cable ports	Number and type	5 x 10BASE-T/100BASE-TX ports		8 x 10BASE-T/100BASE-TX ports	
		Shielded connectors	M12 (type D)		RJ45	
		Medium	Shielded twisted pair, category CAT 5E			
		Total length of pair	100 m			
	Ethernet services	Storage and re-routing of received data, auto MDI/MDX, automatic negotiation of 10/100 Mbit/s and duplex mode (on each port), automatic change of polarity		-		
Topology	Number of switches	Cascaded	Unlimited			
		Redundant in a ring	-			
Redundancy			-			
Power supply	Voltage	24 V $\bar{\text{---}}$ (18...32), safety extra low voltage (SELV per IEC 61140)				
	Consumption	mA max.	100	125 (290 max.)		
	Removable terminal block		5-way, M12 (type A, male)	5-way		
Operating temperature		0...+60°C				
Relative humidity			-			
Degree of protection			IP 67	IP 20		
Dimensions		W x H x D	60 x 126 x 31 mm		47 x 135 x 111 mm	
Mounting		On symmetrical DIN rail, 35 mm wide				
Weight			0.210 kg		0.230 kg	
Conforming to standards			cUL 508 and CSA 22.2 No. 142		cUL 60950, UL 508 and CSA 22.2 No. 142, UL 1604 and CSA 22.2 No. 213 Class 1 Division 2, CE, GL, C-Tick	
LED indicators			Power supply, link status, line activity		P1 and P2 power supplies, Ethernet link/port status	
Alarm relay			-		Power supply detected fault, Ethernet network detected fault or communication port detected fault (volt-free contact 1 A max. at 24 V $\bar{\text{---}}$)	
Reference			TCS ESU 051F0		499 NES 181 00	
IP 67 cables						
Ethernet cables		Preformed with connectors at each end (see page 3/27)				
Power supply cables		Preformed with M12 female straight connectors at each end		Preformed with female M12 angled connectors at each end		
		Length 2 m	Length 2 m	Length 2 m	Length 2 m	
Reference		XZC P1164L2	XZC P1164L5	XZC P1264L2	XZC P1264L5	
Power supply connectors		Female M12 straight connector		Female M12 angled connector		
Reference		XZC C12 FDM 50B		XZC C12 FCM 50B		

Specifications and references: 3, 4 and 5 ports, twisted pair and fiber optic



Switches			Twisted pair, unmanaged		
Interfaces	Copper cable ports	Number and type	3 x 10BASE-T/ 100BASE-TX ports	4 x 10BASE-T/ 100BASE-TX ports	5 x 10BASE-T/ 100BASE-TX ports
		Shielded connectors	RJ45		
		Medium	Shielded twisted pair, category CAT 5E		
		Total length of pair	100 m		
	Fiber optic ports	Number and type	–	1 x 100BASE-FX port	–
		Connectors	–	Duplex SC	–
		Medium	–	Multimode optical fiber	–
		Length of optical fiber			
		50/125 µm fiber	–	5000 m (1)	–
		62.2/125 µm fiber	–	4000 m (1)	–
Attenuation analysis	50/125 µm fiber	–	8 dB	–	
	62.2/125 µm fiber	–	11 dB	–	
Ethernet services		Storage and re-routing of received data, auto MDI/MDX (automatic switching depending on whether cables are straight or crossed), automatic negotiation of 10/100 Mbit/s and duplex mode (on each port), automatic change of polarity			
Topology	Number of switches	Cascaded	Unlimited		
		Redundant in a ring	–		
Redundancy			–		
Power supply	Voltage, safety extra low voltage (SELV per IEC 61140)		24 V \pm (9.6...32 V \pm), safety extra low voltage (SELV)		
	Consumption		2.2 W max.	3.9 W max.	2.2 W max.
	Connector		3-way removable screw terminal block		
Operating temperature			0...+ 60°C		
Relative humidity			Max. 95% (non-condensing)		
Degree of protection			IP 30		
Dimensions		W x H x D	25 x 114 x 79 mm		
Weight			0.113 kg	0.120 kg	0.113 kg
Conforming to standards			UL 508 and CSA 22.2 No. 142 IEC/EN 61131-2, IEC 60825-1 class 1, CISPR 11A		
LED indicators			Power supply, copper port activity, 10 or 100 Mbps data rate		
Alarm relay			–	Fiber port activity and status	–
			–		
Reference			TCS ESU 033FN0	TCS ESU 043F1N0	TCS ESU 053FN0

(1) Length is dependent on the attenuation analysis and attenuation of the optical fiber (typical value: 2000 m).

Modicon® M340™ automation platform

Ethernet network
Cabling system
ConneXium™ unmanaged switches

Specifications and references: 5 ports, twisted pair and fiber optic

Transparent
Ready.



3

Switches			Copper twisted pair and fiber optic, unmanaged			
Interfaces	Copper cable ports	Number and type	4 x 10BASE-T/100BASE-TX ports	3 x 10BASE-T/100BASE-TX ports	4 x 10BASE-T/100BASE-TX ports	3 x 10BASE-T/100BASE-TX ports
		Shielded connectors	RJ45			
		Medium	Shielded twisted pair, category CAT 5E			
		Total length of pair	100 m			
	Fiber optic ports	Number and type	1 x 100BASE-FX port	2 x 100BASE-FX ports	1 x 100BASE-FX port	2 x 100BASE-FX ports
		Connectors	SC			
		Medium	Multimode optical fiber		Single mode optical fiber	
		Length of optical fiber				
		50/125 µm fiber	5000 m (1)		-	
		62.2/125 µm fiber	4000 m (1)		-	
9/125 µm fiber	-		32,500 m (2)			
Attenuation analysis						
50/125 µm fiber	8 dB		-			
62.2/125 µm fiber	11 dB		-			
9/125 µm fiber	-		16 dB			
Topology	Number of switches	Cascaded	Unlimited			
		Redundant in a ring	-			
Redundancy		P1 and P2 redundant power supplies				
Power supply	Voltage	24 V ~ (18...32), safety extra low voltage (SELV per IEC 61140)				
	Power consumption mA max.	200	240	200	240	
	Removable connector	5-way				
Operating temperature		- 40... + 70°C				
Relative humidity		10...95% non-condensing				
Degree of protection		IP 20				
Dimensions		W x H x D	47 x 135 x 111 mm			
Mounting		On symmetrical DIN rail, 35 mm wide				
Weight			0.330 kg	0.335 kg	0.330 kg	0.335 kg
Conforming to standards		cUL 60950, cUL 508 and CSA 22.2 No. 142, UL 1604 and CSA 22.2 No. 213 Class 1 Division 2, CE, GL, C-Tick				
LED indicators		P1 and P2 power supplies, Ethernet link status, transmission activity				
Alarm relay		Activity, power supply detected fault, Ethernet network detected fault or communication port detected fault (volt-free contact 1 A max. at 24 V ~)				
Reference		499 NMS 251 01	499 NMS 251 02	499 NSS 251 01	499 NSS 251 02	

(1) Length is dependent on the attenuation analysis and attenuation of the optical fiber (typical value: 2000 m).

(2) Length is dependent on the attenuation analysis and attenuation of the optical fiber (typical value: 15,000 m).

Modicon® M340™ automation platform

Ethernet network
Cabling system
ConneXium™ managed switches

Specifications and references: 4 ports, twisted pair and fiber optic

Transparent
Ready



Switches			Copper twisted pair and fiber optic, managed			
Interfaces	Copper cable ports	Number and type	3 x 10/100BASE-TX ports	2 x 10/100BASE-TX ports	3 x 10/100BASE-TX ports	2 x 10/100BASE-TX ports
		Shielded connectors	RJ45			
		Medium	Shielded twisted pair, category CAT 5E			
		Total length of pair	100 m			
	Fiber optic ports	Number and type	1 x 100BASE-FX port	2 x 100BASE-FX ports	1 x 100BASE-FX port	2 x 100BASE-FX ports
		Connectors	Duplex SC			
		Medium	Multimode optical fiber		Single mode optical fiber	
		Length of optical fiber				
		50/125 µm fiber	5000 m (1)		-	
		62.2/125 µm fiber	4000 m (1)		-	
9/125 µm fiber	-		32,500 m (2)			
Ethernet services	Attenuation analysis					
	50/125 µm fiber	8 dB		-		
	62.2/125 µm fiber	11 dB		-		
		9/125 µm fiber	-		16 dB	
Topology	Number of switches	Cascaded	Unlimited			
		Redundant in a ring	Up to 50			
Redundancy		Redundant power supplies, redundant single ring, ring coupling				
Power supply	Voltage	Operation	9.6...60 V ~/18...30 V ~, safety extra low voltage (SELV per IEC 61140)			
	Power consumption		6.5 W	7.3 W	6.5 W	7.3 W
	Removable connector		6-way			
Operating temperature		0...+ 60°C				
Relative humidity		10...90% non-condensing				
Degree of protection		IP 20				
Dimensions		W x H x D	47 x 131 x 111 mm			
Mounting		On symmetrical DIN rail, 35 mm wide				
Weight		0.400 kg				
Conforming to standards		IEC 61131-2, IEC 61850-3, UL 508, UL 1604 Class 1 Division 2, CSA 22.2 No. 142 (cUL), CSA 22.2 No. 213 Class 1 Division 2 (cUL), CE, GL, C-Tick				
LED indicators		Power supply status, alarm relay status, active redundancy, redundancy management, copper port status and copper port activity				
Alarm relay		Power supply detected fault, Ethernet network detected fault, communication port detected fault, redundancy detected fault (volt-free contact 1 A max. at 24 V ~)				
Reference		TCS ESM 043F1CU0	TCS ESM 043F2CU0	TCS ESM 043F1CS0	TCS ESM 043F2CS0	

(1) Length is dependent on the attenuation analysis and attenuation of the optical fiber (typical value: 2000 m).

(2) Length is dependent on the attenuation analysis and attenuation of the optical fiber (typical value: 15,000 m).

3

Modicon® M340™ automation platform

Ethernet network
Cabling system
ConneXium™ managed switches

Specifications and references: 4 and 8 ports, twisted pair

Transparent
Ready.



3

Switches			Copper twisted pair, managed	
Interfaces	Copper cable ports	Number and type	4 x 10/100BASE-TX ports	8 x 10/100BASE-TX ports
		Shielded connectors	RJ45	
		Medium	Shielded twisted pair, category CAT 5E	
		Total length of pair	100 m	
	Fiber optic ports	Number and type	–	
		Connectors	–	
		Medium	–	
		Length of optical fiber	–	
		50/125 µm fiber	–	
		62.2/125 µm fiber	–	
		9/125 µm fiber	–	
	Attenuation analysis	50/125 µm fiber	–	
		62.2/125 µm fiber	–	
9/125 µm fiber		–		
Ethernet services		FDR, SMTP V3, SNMP client, multicast filtering for optimization of the Global Data protocol, configuration via Web access VLAN, IGMP Snooping, RSTP (<i>Rapid Scanning Tree Protocol</i>), priority port, data stream control, secure port		
Topology	Number of switches	Cascaded	Unlimited	
		Redundant in a ring	Up to 50	
Redundancy			Redundant power supplies, redundant single ring, ring coupling	
Power supply	Voltage	Operation	9.6...60 V $\overline{\text{---}}$ /18...30 V \sim , safety extra low voltage (SELV per IEC 61140)	
	Power consumption		5.3 W	5.3 W
	Removable connector		6-way	
Operating temperature			0...+60°C	
Relative humidity			10...90% non-condensing	
Degree of protection			IP 20	
Dimensions		W x H x D	47 x 131 x 111 mm	74 x 131 x 111 mm
Mounting			On symmetrical DIN rail, 35 mm wide	
Weight			0.400 kg	0.410 kg
Conforming to standards			IEC/EN 61131-2, IEC 61850-3, UL 508, UL 1604 Class 1 Division 2, CSA 22.2 No. 214 (cUL), CSA 22.2 No. 213 Class 1 Division 2 (cUL), CE, GL, C-Tick	
LED indicators			Power supply status, alarm relay status, active redundancy, redundancy management, copper port status and copper port activity	Power supply status, alarm relay status, active redundancy, redundancy management, fiber port status and fiber port activity
Alarm relay			Power supply detected fault, Ethernet network detected fault or communication port detected fault (volt-free contact 1 A max. at 24 V $\overline{\text{---}}$)	
Reference			TCS ESM 043F23F0	TCS ESM 083F23F0

Modicon® M340™ automation platform

Ethernet network
Cabling system
ConneXium™ managed switches

Specifications and references: 8 ports, twisted pair and fiber optic

Transparent
Ready



Switches			Copper twisted pair and fiber optic, managed			
Interfaces	Copper cable ports	Number and type	7 x 10/100BASE-TX ports	6 x 10/100BASE-TX ports	7 x 10/100BASE-TX ports	6 x 10/100BASE-T ports
		Shielded connectors	RJ45			
		Medium	Shielded twisted pair, category CAT 5E			
		Total length of pair	100 m			
	Fiber optic ports	Number and type	1 x 100BASE-FX port	2 x 100BASE-FX ports	1 x 100BASE-FX port	2 x 100BASE-FX ports
		Connectors	Duplex SC			
		Medium	Multimode optical fiber		Single mode optical fiber	
		Length of optical fiber	50/125 µm fiber		–	
			62.2/125 µm fiber		–	
			9/125 µm fiber		32,500 m (2)	
Ethernet services	Attenuation analysis		50/125 µm fiber		8 dB	
			62.2/125 µm fiber		11 dB	
			9/125 µm fiber		–	
Ethernet services			FDR, SMTP V3, Sntp client, multicast filtering for optimization of the Global Data protocol, configuration via Web access VLAN, IGMP Snooping, RSTP (<i>Rapid Scanning Tree Protocol</i>), priority port, data stream control, secure port			
Topology	Number of switches	Cascaded	Unlimited			
		Redundant in a ring	Up to 50			
Redundancy			Redundant power supplies, redundant single ring, ring coupling			
Power supply	Voltage	Operation	9.6...60 V $\overline{\text{DC}}$ /18...30 V \sim , safety extra low voltage (SELV per IEC 61140)			
	Power consumption		6.5 W	7.3 W	6.5 W	7.3 W
	Removable connector		6-way			
Operating temperature			0...+ 60°C			
Relative humidity			10...90% non-condensing			
Degree of protection			IP 20			
Dimensions	W x H x D		74 x 131 x 111 mm			
Mounting			On symmetrical DIN rail, 35 mm wide			
Weight			0.410 kg			
Conforming to standards			IEC/EN 61131-2, IEC 61850-3, UL 508, UL 1604 Class 1 Division 2, CSA 22.2 No. 214 (cUL), CSA 22.2 No. 213 Class 1 Division 2 (cUL), CE, GL, C-Tick			
LED indicators			Power supply status, alarm relay status, active redundancy, redundancy management, fiber port status and fiber port activity			
Alarm relay			Power supply detected fault, Ethernet network detected fault or communication port detected fault (volt-free contact 1 A max. at 24 V $\overline{\text{DC}}$)			
Reference			TCS ESM 083F1CU0	TCS ESM 083F2CU0	TCS ESM 083F1CS0	TCS ESM 083F2CS0

(1) Length is dependent on the attenuation analysis and attenuation of the optical fiber (typical value: 2000 m).

(2) Length is dependent on the attenuation analysis and attenuation of the optical fiber (typical value: 15,000 m).

Modicon® M340™ automation platform

Ethernet network
Cabling system
ConneXium™ managed switches

Specifications and references: 16 and 24 ports, twisted pair and fiber optic

Transparent
Ready.



3

Switches			Copper twisted pair, managed	Copper twisted pair and fiber optic, managed			
Interfaces	Copper cable ports	Number and type	16 x 10/100BASE-TX ports	14 x 10/100BASE-TX ports	22 x 10/100BASE-TX ports		
		Shielded connectors	RJ45				
		Medium	Shielded twisted pair, category CAT 5E				
		Total length of pair	100 m				
	Fiber optic ports	Number and type	–	2 x 100BASE-FX ports			
		Connectors	–	Duplex SC			
		Medium	–	Multimode optical fiber			
		Length of optical fiber	50/125 µm fiber	–	5000 m (1)		
			62.2/125 µm fiber	–	4000 m (1)		
			9/125 µm fiber	–	–		
Attenuation analysis	50/125 µm fiber	–	8 dB				
	62.2/125 µm fiber	–	11 dB				
	9/125 µm fiber	–	–				
Ethernet services	FDR, SMTP V3, SNMP client, multicast filtering for optimization of the Global Data protocol, configuration via Web access VLAN, IGMP Snooping, RSTP (<i>Rapid Scanning Tree Protocol</i>), priority port, data stream control, secure port						
Topology	Number of switches	Cascaded	Unlimited				
		Redundant in a ring	Up to 50				
Redundancy			Redundant power supplies, redundant single ring, ring coupling				
Power supply	Voltage	Operation	9.6...60 V $\overline{\text{---}}$ /18...30 V \sim , safety extra low voltage (SELV per IEC 61140)				
	Power consumption		9.4 W	11.8 W	15.5 W		
	Removable connector		6-way				
Operating temperature			0...+60°C				
Relative humidity			10...90% non-condensing				
Degree of protection			IP 20				
Dimensions		W x H x D	111 x 131 x 111 mm				
Mounting			On symmetrical DIN rail, 35 mm wide				
Weight			0.600 kg	0.650 kg			
Conforming to standards			cUL 60950, UL 508 and CSA 22.2 No. 142, UL 1604 and CSA 22.2 No. 213 Class 1 Division 2, CE, GL, C-Tick				
LED indicators			Redundant power supplies, single ring	Redundant power supplies, single ring, double ring			
Alarm relay			Power supply detected fault, Ethernet network detected fault or communication port detected fault (volt-free contact 1 A max. at 24 V $\overline{\text{---}}$)				
Reference			TCS ESM 163F23F0	TCS ESM 163F2CU0	TCS ESM 243F2CU0		

(1) Length is dependent on the attenuation analysis and attenuation of the optical fiber (typical value: 2000 m).

Modicon® M340™ automation platform

Ethernet network
Cabling system
ConneXium™ managed switches

Specifications and references: 8 ports and 2 Gigabit ports, twisted pair, fiber optic

Transparent
Ready



Switches			Copper twisted pair and fiber optic, managed			Copper twisted pair, managed			
Interfaces	Copper cable ports	Number and type	8 x 10/100BASE-TX ports			8 x 10/100BASE-TX ports and 2 x 10/100/1000BASE-TX (Gigabit) ports			
		Shielded connectors	RJ45						
		Medium	Shielded twisted pair, category CAT 5E						
		Total length of pair	100 m						
	Fiber optic Gigabit ports (with SFP fiber module to be mounted on SFP connector)	Number and type	2 x 1000BASE-SX ports (1)	2 x 1000BASE-LH ports (2)	2 x 1000BASE-LX ports (3)	–			
		Connectors	LC						
		Medium	Multimode optical fiber	Single mode optical fiber	Single mode and multimode optical fiber	–			
		Length of optical fiber	50/125 µm fiber	550 m	–	550 m	–		
			62.2/125 µm fiber	275 m	–	550 m	–		
			9/125 µm fiber	–	8 - 72,000 m	20,000 m	–		
		Attenuation analysis	50/125 µm fiber	7.5 dB	–	11 dB	–		
			62.2/125 µm fiber	7.5 dB	–	11 dB	–		
	9/125 µm fiber		–	6 - 22 dB	11 dB	–			
	Ethernet services	FDR, SMTP V3, SNMP client, multicast filtering for optimization of the Global Data protocol, configuration via Web access VLAN, IGMP Snooping, RSTP (Rapid Scanning Tree Protocol), priority port, data stream control, secure port							
Topology	Number of switches	Cascaded	Unlimited						
		Redundant in a ring	Up to 50						
Redundancy	Redundant power supplies, redundant single ring, ring coupling								
Power supply	Voltage	Operation	9.6...60 V $\overline{\text{---}}$ /18...30 V \sim , safety extra low voltage (SELV per IEC 61140)						
	Power consumption		8.9 W + 1 W per SFP fiber module			8.3 W			
	Removable connector		6-way						
Operating temperature	0...+60°C								
Relative humidity	10...90% non-condensing								
Degree of protection	IP 20								
Dimensions	W x H x D	111 x 131 x 111 mm							
Mounting	On symmetrical DIN rail, 35 mm wide								
Weight	0.410 kg								
Conforming to standards	cUL 60950, UL 508 and CSA 22.2 No. 142, UL 1604 and CSA 22.2 No. 213 Class 1 Division 2, CE, GL								
LED indicators	Power supply status, alarm relay status, active redundancy, redundancy management, fiber port status and fiber port activity								
Alarm relay	Power supply detected fault, Ethernet network detected fault or communication port detected fault (volt-free contact 1 A max. at 24 V $\overline{\text{---}}$)								
Reference	TCS ESM 103F2LG0			TCS ESM 103F23G0					

- (1) With TCS EAA F1LFU00 fiber optic module to be ordered separately. See page 3/27.
 (2) With TCS EAA F1LFH00 fiber optic module to be ordered separately. See page 3/27.
 (3) With TCS EAA F1LFS00 fiber optic module to be ordered separately. See page 3/27.

Introduction

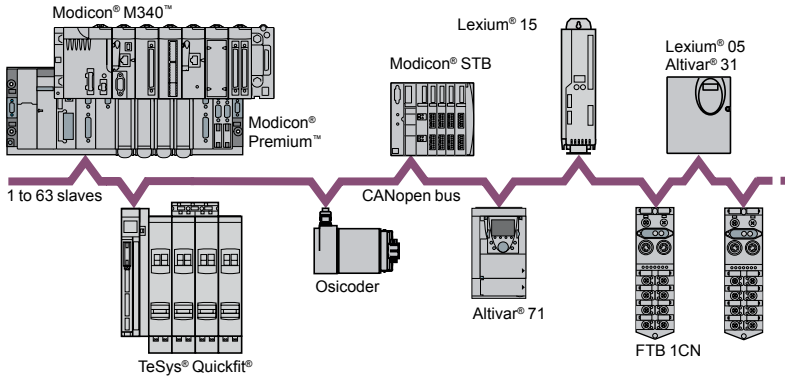

Schneider Electric has selected CANopen™ for its products and installations because of its functioning and how it benefits the automation industry. This decision was based on the general acceptance of CANopen, and the fact that CANopen products are increasingly used in control system architectures.

CANopen is an open network supported by more than 400 companies worldwide, and is manufactured by CAN in Automation. CANopen conforms to standards EN 50325-4 and ISO 15745-2.

Schneider Electric is heavily involved in working with numerous standards and certification groups. These groups are important for properly designing machine and installation architectures, systems and products.

CANopen brings transparency to Ethernet

CAN in Automation and Modbus®-IDA have worked together to create a standard that helps ensure total transparency between CANopen and Modbus/TCP. The result of this collaboration has been the CiA DSP309-2 specification, defining communication standards between a Ethernet Modbus/TCP network and a CANopen bus.

The specification defines mapping services enabling CANopen devices to communicate with a Modbus/TCP network through a gateway. The data in a CANopen device can be accessed in both read and write mode.

This specification is the first standard available for developing an open standard communication between Modbus/TCP and CANopen. It is driving Schneider Electric network solutions toward better integration, diagnostics and configuration of distributed applications. It allows machines and installations to be connected to an Ethernet network continuously, while combining the advantages of each network in its specific area.

The CANopen bus is a multi-master bus that helps to ensure reliable, deterministic access to real-time data in control system devices. The CSMA/CA protocol is based on broadcast exchanges, sent cyclically or on an event, to help ensure optimum use of the passband. A message handling channel can also be used to define slave parameters.

On the Modicon® M340™ platform, the bus uses a double twisted pair cable. Up to 63 devices can be connected by using a daisy-chain or tap junction architectures. The variable data rate between 20 Kbit/s and 1 Mbit/s depends on the length of the bus (between 20 m and 2,500 m). Each end of the bus must be fitted with a line terminator.

The CANopen bus is a set of profiles on CAN systems, possessing the following specifications:

- Open bus system
- Data exchanges in real time without overloading the protocol
- Modular design allowing modification of size
- Interconnection and interchangeability of devices
- Standardized configuration of networks
- Access to device parameters
- Synchronization and circulation of data from cyclic and/or event-controlled processes (short system response time)

Connectable devices

The Modicon M340 automation platform, via its **BMX P34 2010/2030** processors with integrated CANopen link, performs the role of master on the machine bus.

The following Telemecanique devices can be connected to the CANopen bus:

- Ø 58 mm Osicoder multi-turn absolute encoders:
 - **XCC 3510P/3515C S84CB**, version ≥ 1.0
- TeSys® U starter-controllers:
 - with **LUL C08** communication module, version ≥ 1.2
- TeSys T motor management system:
 - with LTM R●●C●● controllers, version ≥ 1.0
- TeSys D motor-starters, using the TeSys Quickfit installation help system:
 - with **APP 1CC00/O2** communication module, version ≥ 1.0



TeSys® Quickfit®

Connectable devices (continued)

- Modicon® OTB IP 20 Optimum distributed I/O (with Twido I/O extension modules):
 - with **OTB 1C0 DM9LP** interface module, version ≥ 2.03
- Modicon® STB IP 20 modular distributed I/O:
 - with NIM module **STB NCO 1010**, version ≥ 1.0 or **STB NCO 2212**, version ≥ 2.02
- Modicon® FTB/FTM IP 67 I/O splitter boxes:
 - **FTB 1CN●●●●●** monobloc, ver. ≥ 1.07 and FTM 1CN10 modular, all versions
- Preventa™ configurable safety controllers:
 - **XPS MC16ZC/32ZC**, version ≥ 1.10
- Altivar® 31 variable speed drives for asynchronous motors 0.18...15 kW:
 - **ATV 31H ●●●●●**, version ≥ 1.1 (1)
- Altivar® 71/61 variable speed drives for asynchronous motors 0.75...630 kW:
 - **ATV 61H /71H ●●●●●**, version ≥ 1.1 (1)
- Lexium® 05 servo drives (0.4...6 kW) for BSH servo motors:
 - **LXM 05A●D●●●●**, version ≥ 1.120 (2)
- Lexium® 15 servo drives (0.9...42.5 kW) for BDH or BSH servo motors:
 - **LXM 15L●**, version ≥ 1.45 (3) and **LXM 15MD/15HP**, version ≥ 6.64 (4)
- IclA intelligent compact motor-drives:
 - **IFA 6●**, ver. ≥ 1.105 (5), **IFE 71**, ver. ≥ 1.104 (5) and **IFS 6●/9●**, ver. ≥ 1.107 (5)

(1) Requires the PowerSuite software workshop **VW3 A8 104**, version ≥ 2.00.
 (2) Requires the PowerSuite software workshop for Lexium 05 **VW3 A8 104**, ver. 2.2.0 patch V2.B.
 (3) Requires the Unilink software, version ≥ 1.5.
 (4) Requires the Unilink software, version ≥ 4.0.
 (5) Requires the IclA Easy software, version ≥ 1.104.

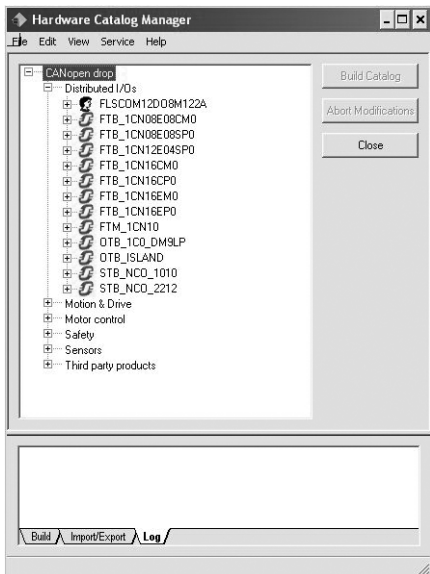

Hardware Catalog Manager for integration of third party devices

Software setup via Unity™ Pro

Third party devices integration

Unity Pro software, version ≥ 4.0, has a Hardware Catalog Manager tool for integration of third party devices of the same level as Schneider Electric devices. These third party devices, with its EDS file must be conform with the CIA standards (CAN In Automation). The Hardware Catalog Manager tool allows:

- Integrating third party devices into Unity Pro software.
- Minimizing the size of the **BMX P34 2010/2030** processor memory reserved for PDO process variables.
- Customizing the Unity Pro device parameters.

Configuration of bus

Configuration of the CANopen bus on the Modicon™ M340™ platform is fully integrated in the Unity Pro software. From the Unity Pro graphic editor, simply select the devices available in the catalog and assign them their CANopen slave address. Exchanges between the CANopen bus and the Modicon M340 processor can be assigned by configuration to the fast or master task.

Predefined profiles or functions are used to create the user interface automatically using process variables (PDO), in such a way that any subsequent modification to the mapping of these variables will have no impact on their topological addressing. Depending on the devices, dedicated configuration screens are used to assign the initial parameters.

The dedicated screens are available for CANopen specialists who wish to optimize the performance of the CANopen bus or to re-assign the Process Data Objects (PDO) differently.

A cyclical access to the Service Data Object (SDO) corresponding to any CANopen object of a particular device is possible using the application's standard communication functions READ_VAR and WRITE_VAR, or even from the Unity Pro diagnostic screens. These screens can be used to display the bus status graphically, as well as to access the diagnostics sent by an inoperative device with a single click of the mouse.

Note: The max. number (63) of slave equipments connected on CANopen bus depends on the type of devices. It is necessary to create an objects table (PDO/Cob Id) and occupation of memory table (%Mi and Mwi). The sheet on pages 6/8 and 6/9, can be used to calculate by column (or group of columns) and check that:
 $\Sigma (\text{objects} \times \text{nb of products}) \leq \text{max. capacity}$

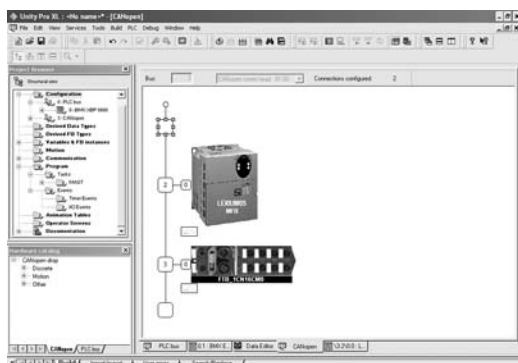

Example of Unity™ Pro configuration screen for Lexium® 05 servo drive and Modicon® FTB IP 67 I/O splitter box

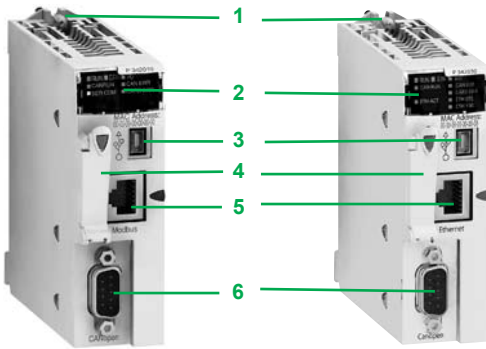

BMX P34 2010

BMX P34 2030

Description

Both of the performance processors on the Modicon® M340™ platform, **BMX P34 2010** and **BMX P34 2030**, have an integrated CANopen communication port. They have the following on the front panel:

- 1 Screw for securing the module in its slot (marked 0) in the rack
- 2 A display block comprised of at least:
 - CAN RUN LED (green): Integrated machine/installation bus operational
 - CAN ERR LED (red): Integrated machine/installation bus inoperative
- 3 A mini B USB connector for a programming terminal
- 4 A slot equipped with Flash memory card for backing up the application
- 5 An RJ45 connector for serial link (with **BMX P34 2010** model) or Ethernet Modbus®/TCP port (with **BMX P34 2030** model)
- 6 A 9-way SUB-D connector for the CANopen Master machine and installation bus

3

Specifications (1)

Type of bus		CANopen								
CANopen services	Conformity class	M20								
	Standard	DS 301 V 04.02, 303-2								
	Device profile	DS 405								
	Special	–								
Structure	Physical interface	9-way male SUB-D								
	Topology	Devices connected by daisy-chaining and/or tap junctions								
	Access method	CSMA/CA, carrier sense consumer/producer principle, collision detection and arbitration of message priorities								
	Application layer	Messages carrying objects: process data (PDO), service data (SDO), network management (NMT), special functions (SYNC, EMCY, TIME)								
Transmission	Data rate	20 Kbit/s...1 Mbit/s depending on bus length								
	Medium	Double shielded twisted pair								
CANopen physical configuration (1)	No. of slave devices	Max. 63								
	Data rate	1 Mbit/s	800 Kbit/s	500 Kbit/s	250 Kbit/s	125 Kbit/s	50 Kbit/s	20 Kbit/s		
	Maximum length of bus (2)	m	20	40	100	250	500	1000	2500	
	Maximum length of tap-offs on one tap junction (3)	m	0.6	6	10	10	10	120	300	
	Limitation per segment	No. of devices	64	32	16					
Maximum length of segment (4)		m	160	185	205					
Modicon® M340™ processor			BMX P34 2010				BMX P34 2030			
	No. of racks		4 (4, 6, 8 or 12 slots)							
	Maximum no. of slots		48 for processor and modules (excluding power supply module)							
	Maximum no. in rack	Discrete I/O	1,024							
		Analog I/O	256							
		Process control	Programmable loops (via CONT-CTL process control EFB library)							
		App. specific	36 channels (counter, motion control and serial link)							
	Integrated connections	Motion	Independent axes on CANopen bus (via MFB library)							
		Ethernet	–				1 RJ45 port, 10/100 Mbit/s			
		CANopen bus	1 master (9-way SUB-D)							
		Serial link	1 RJ45 port, Modbus master/slave or character mode				–			
Communication module	USB port	1 port, 12 Mbit/s								
	Ethernet Modbus®/TCP	Max. 2 modules of one RJ45 port, 10/100 Mbit/s with Transparent Ready server: - class B30 standard web server with BMX NOE 0100 module - class C30 configurable web server with BMX NOE 0110 module								
Internal RAM capacity		Kb	4,096 including 3,584 for the program, constants and symbols and 256 for data							

(1) For more information, please refer to the "Machines & Installations with industrial communications" catalog.

(2) Deduct 15 m per repeater from the length of the bus.

(3) For other restrictions, please refer to the CANopen hardware setup manual available at www.schneider-electric.us/.

(4) With the use of **TSX CAN C●50/100/300** CANopen cables and **TSX CAN C●DD03/1/3/5** preformed cordsets.

Modicon® M340™ Performance processors with integrated CANopen bus link



BMX P34 2010



BMX P34 2030

Modicon M340 processor modules are supplied with the **BMX RMS 008MP** Flash memory card. This card performs the following actions transparently:

- Backing up the application (program, symbols and constants) supported in the processor internal RAM that is not backed up
- Activation of the Transparent Ready® class B10 standard web server (with **BMX P34 2030** processor)

This card can be replaced by another card featuring a file storage option. See page 1/9.

I/O capacity	Memory capacity	Max. no. of network modules	Integrated communication ports	Reference	Weight kg
Performance BMX P340 20, 4 racks					
1,024 discrete I/O 256 analog I/O 36 app-sp. channels	4,096 Kb integrated	2 Ethernet Modbus/TCP network	CANopen bus Modbus® serial link	BMX P34 2010	0.210
			CANopen bus Ethernet Modbus/TCP network	BMX P34 2030	0.215



CANopen bus wiring system

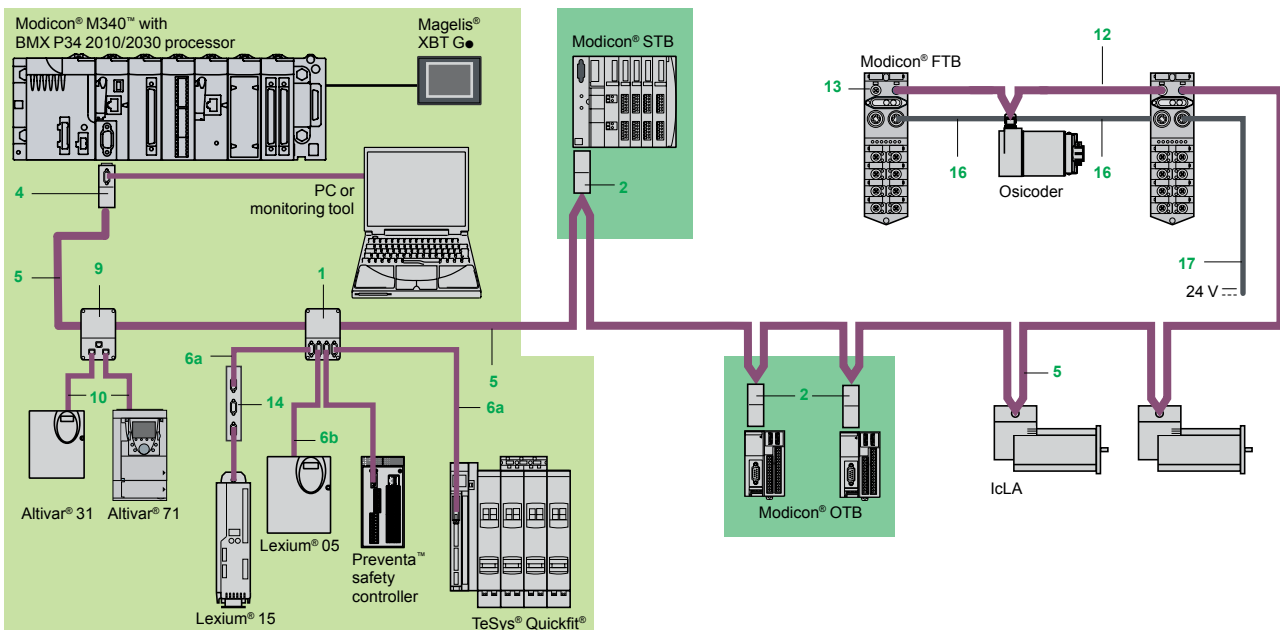

Note: For numbers and references 1 through 17, see pages 3/42 and 3/43.

Different types of cables are available, making it possible to create any type of application, including for harsh environments. For a definition of standard and harsh environments, see page 3/42.

Several connectors are available to meet any requirement: straight or 90° angled connectors, or angled connectors with the option of connecting a PC or diagnostic pocket PC.

Power can be supplied to the equipment by means of cables, cordsets and tap junctions: one AWG24 pair for the CAN signals, one AWG22 pair for the power supply and the ground.

In addition to the IP 20 wiring offer, there is also an IP 67 wiring offer.

Modicon® M340™ automation platform

CANopen machine and installation bus Wiring system



TSX CAN TDM4



VW3 CAN TAP2



TSX CAN KCD F90T



TSX CAN KCD F180T



TSX CAN KCD F90TP

Standard tap junctions and connectors

Designation	Description	No. (1)	Length	Reference	Weight kg
IP 20 CANopen tap junction	4 SUB-D ports. Screw terminal block for connection of trunk cables Line termination	1	–	TSX CAN TDM4	0.196
IP 20 connectors CANopen female	90° angled	2	–	TSX CAN KCDF 90T	0.046
	Straight (2)	–	–	TSX CAN KCDF 180T	0.049
	90° angled with 9-way SUB-D for connecting a PC or diagnostic tool	4	–	TSX CAN KCDF 90TP	0.051
IP 67 M12 connectors	Male	–	–	FTX CN 12M5	0.050
	Female	–	–	FTX CN 12F5	0.050
IP 20 CANopen tap junctions for Altivar® and Lexium® 05	2 RJ45 ports	9	–	VW3 CAN TAP2	–

IP 20 standard cables and preformed cordsets

Designation	Description	No. (1)	Length	Unit reference	Weight kg
CANopen cables (AWG 24)	Standard, CE marking: low smoke. Halogen-free. Flame-retardant (IEC 60332-1)	5	50 m	TSX CAN CA50	4.930
			100 m	TSX CAN CA100	8.800
			300 m	TSX CAN CA300	24.560
	Standard, UL certification, CE marking: flame-retardant (IEC 60332-2)	5	50 m	TSX CAN CB50	3.580
			100 m	TSX CAN CB100	7.840
			300 m	TSX CAN CB300	21.870
	For harsh environments (3) or mobile installation, CE marking: low smoke. Halogen-free. Flame-retardant (IEC 60332-1). Resistance to oils	5	50 m	TSX CAN CD50	3.510
			100 m	TSX CAN CD100	7.770
			300 m	TSX CAN CD300	21.700
CANopen preformed cordsets One 9-way female SUB-D connector at each end (AWG 24)	Standard, CE marking: low smoke. Halogen-free. Flame-retardant (IEC 60332-1)	6a	0.3 m	TSX CAN CADD03	0.091
			1 m	TSX CAN CADD1	0.143
			3 m	TSX CAN CADD3	0.295
			5 m	TSX CAN CADD5	0.440
			Standard, UL certification, CE marking: flame-retardant (IEC 60332-2)	6a	0.3 m
	1 m	TSX CAN CBDD1	0.131		
	3 m	TSX CAN CBDD3	0.268		
	5 m	TSX CAN CBDD5	0.400		
	One 9-way SUB-D connector, One RJ45 connector (AWG 24)	6b	0.5 m		TCS CCN 4F3M05T
			1 m	TCS CCN 4F3M1T	–
			VW3 M38 05 R010 (4)	–	
3 m			TCS CCN 4F3M3T	–	
CANopen preformed cordsets Two 9-way SUB-D connectors, one male and one female	–	0.5 m	TLA CD CBA 005	–	
		1.5 m	TLA CD CBA 015	–	
		3 m	TLA CD CBA 030	–	
		5 m	TLA CD CBA 050	–	

IP 67 standard preformed cordsets

Designation	Description	No. (1)	Length	Unit reference	Weight kg
CANopen preformed cordsets	Preformed cordsets of two 5-way M12 A-coded angled connectors (one male connector and one female connector)	12	0.3 m	FTX CN 3203	0.40
			0.6 m	FTX CN 3206	0.70
			1 m	FTX CN 3210	0.100
			2 m	FTX CN 3220	0.160
			3 m	FTX CN 3230	0.220
			5 m	FTX CN 3250	0.430

(1) For numbers, see page 3/41.

(2) For connection to Controller Inside programmable card, the VW3 CAN KCDF 180T connector can also be used.

(3) **Standard environment:**

- Without any particular environmental constraints
- Operating temperature between +5°C and +60°C
- Fixed installation

Harsh environment:

- Resistance to hydrocarbons, industrial oils, detergents, solder splashes
- Relative humidity up to 100%
- Saline atmosphere
- Significant temperature variations
- Operating temperature between -10°C and +70°C
- Mobile installation

(4) Cordset includes the line termination.

Modicon® M340™ automation platform

CANopen machine and installation bus Wiring system



VW3 CAN A71



AM0 2CA 001V000

IP 20 connection accessories

Designation	Description	No. (1)	Length	Unit reference	Weight kg
CANopen connector for Altivar® 71 drive (2)	9-way female SUB-D. Switch for line termination. Cables exit at 180°	–	–	VW3 CAN KCDF 180T	–
Adaptor for Altivar 71 drive	CANopen adaptor SUB-D to RJ45	–	–	VW3 CAN A71	–
Preformed CANopen cordsets for Altivar and Lexium® 05 drives	One RJ45 connector at each end	10	0.3 m 1 m	VW3 CAN CARR03 VW3 CAN CARR1	–
CANopen bus adaptor for Lexium 15 servo drive	Hardware interface for a link conforming to the CANopen standard + one connector for a PC terminal	14	–	AM0 2CA 001V000	0.110
Y-connector	CANopen/Modbus®	–	–	TCS CTN011M11F	–

IP 67 connection accessories

For Modicon® FTB monobloc I/O splitter boxes

Designation	Composition	No. (1)	Length m	Reference	Weight kg
IP 67 line terminator	Equipped with one M12 connector (for end of bus)	13	–	FTX CNTL12	0.010
24 V ~ power supply connection cables	Equipped with two 5-way 7/8 connectors	16	0.6	FTX DP2206 FTX DP2210 FTX DP2220 FTX DP2250	0.150 0.190 0.310 0.750
	Equipped with one 5-way 7/8 connector at one end and flying leads at the other end	17	1.5	FTX DP2115 FTX DP2130 FTX DP2150	0.240 0.430 0.700
T-junction box for power supply	Equipped with two 5-way 7/8 connectors	–	–	FTX CNCT1	0,100



FTX DP21

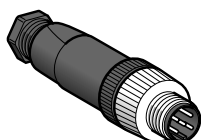

XZ CC12 DM50B

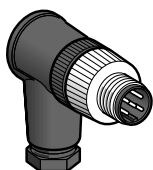

XZ CC12 CM50B



FTX CY1208

Separate parts

Designation	Composition	Sold in lot of	Reference	Weight kg	
Connectors	7/8 type, 5-way	Male	–	FTX C78M5	0.050
		Female	–	FTX C78F5	0.050
	Straight, M12 type, 5 screw terminals	Male	–	XZ CC12MDM50B	0.020
		Female	–	XZ CC12FDM50B	0.020
	Angled, M12 type, 5 screw terminals	Male	–	XZ CC12MCM50B	0.020
		Female	–	XZ CC12FCM50B	0.020
Sealing plugs	For M8 connector (sold in packs of 10)	–	FTX CM08B	0.100	
	For M12 connector (sold in packs of 10)	–	FTX CM12B	0.100	
	For 7/8 connector	–	FTX C78B	0.020	
Y-connector	Connection of two M8 connectors to M12 connector on splitter box	–	FTX CY1208	0.020	
	Connection of two M12 connectors to M12 connector on splitter box	–	FTX CY1212	0.030	
Diagnostics adaptor	Equipped with two M12 connectors	–	FTX DG12	0.020	
Marker labels	For plastic splitter boxes	10	FTX BLA10	0.010	
	For metal splitter boxes	10	FTX MLA10	0.010	

(1) For numbers, see page 3/41.

(2) For ATV 71H...M3, ATV 71HD11M3X, HD15M3X, ATV 71H075N4... HD18N4 drives, this connector can be replaced with the **TSX CAN KCDF 180T** connector.

Introduction

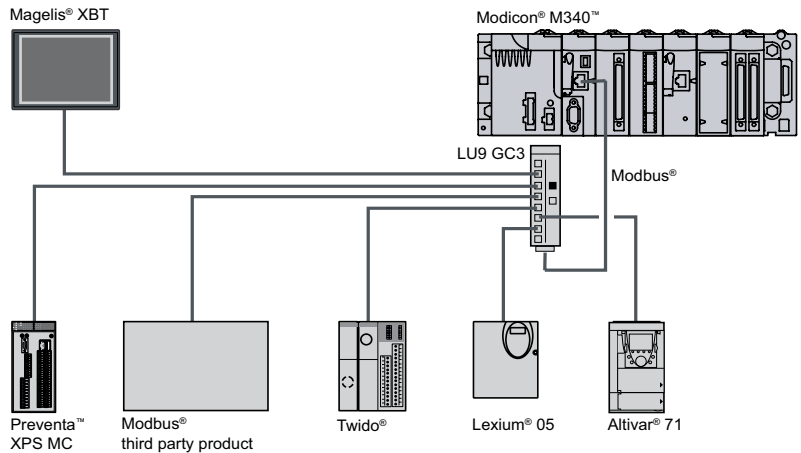

The Modbus® bus is used for master/slave architectures. It is necessary, however, to check that the Modbus services used by the application are implemented on the devices concerned.

The bus comprises one master station and several slave stations. Only the master station can initiate the exchange (direct communication between slave stations is not possible). Two exchange mechanisms are possible:

- Question/answer, where the requests from the master are addressed to a given slave. The master then waits for the response from the slave that was interrogated.
- Broadcasting, the master broadcasts a message to the slave stations on the bus. These stations execute the order without transmitting a response.

Description

The four **BMX P34 1000 / 2000 / 2010 / 2020** processors in the Modicon® M340™ automation platform range integrate a serial link that can operate under Modbus master/slave RTU/ASCII protocol or under character mode protocol.

For this serial port, these processors have the following on the front panel :

- 1 A display block comprised of among other LEDs:
 - SER COM LED (yellow): Activity on the Modbus serial link (lit) or failure on equipment present on the link (flashing).
- 2 An RJ45 connector for the Modbus serial link or character mode link (RS 232C/RS 485, non-isolated) and its black indicator 3.

Note: For complete processor descriptions, see page 1/6.

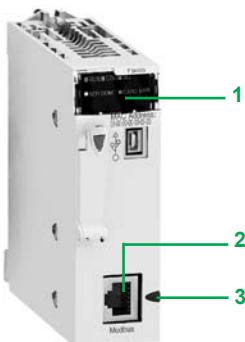

BMX P34 1000/2000

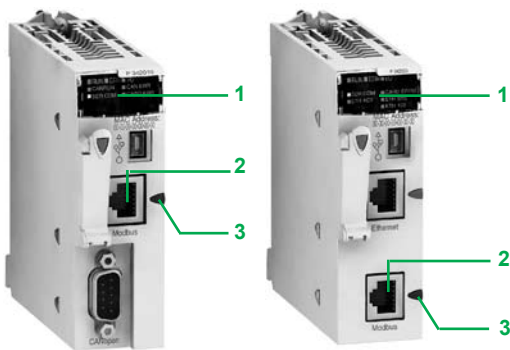

BMX P34 2010



BMX P34 2020

Specifications					
Protocol	Modbus			Character mode	
Structure	Type	Non isolated serial link (1)			
	Method of access	Master/slave type			–
	Physical Interface	RS 232, 2 wires	RS 485, 2 wires		RS 232, 4 wires RS 485, 2 wires
Transmission	Mode	Asynchronous in baseband			Asynchronous in baseband
	Frame	RTU/ASCII, Half duplex			Full duplex Half duplex
	Data rate	0.3...19.2 Kbit/s (default 19.2 Kbit/s)			0.3...19.2 Kbit/s (default 19.2 Kbit/s)
	Medium	Shielded twisted pair			Simple or double shielded twisted pair Shielded twisted pair
Configuration	Number of devices	2 (point-to-point)	32 max. per segment		2 (point-to-point) 32 max. per segment
	Maximum number of link addresses	248			248
	Maximum length of bus	15 m	10 m non isolated link 1000 m isolated link		15 m 10 m non isolated link 1000 m isolated link
	Maximum length of tap links	–	15 m non isolated link 40 m isolated link		– 15 m non isolated link 40 m isolated link
Services	Requests	252 data bytes per RTU request 504 data bytes per ASCII request			1 K data bytes per request
	Security, control parameters	One CRC on each frame (RTU) One LRC on each frame (ASCII)			One LRC on each frame (ASCII)
	Monitoring	Diagnostic counters, event counters			–

(1) For an isolated link, you must use the TWD XCA ISO terminal port cable connector.

Modbus® functions			
Modbus functions available on serial ports integrated to Modicon® M340™ processors	Code	Modbus slave (server)	Modbus master (client)
	01	Read n output bits	Read output bits
	02	Read n input bits	Read input bits
	03	Read n output words	Read words
	04	Read n input words	Read input words
	15	Write n output bits	Write n output bits
	16	Write n output words	Write n output words
	Other code	–	Access any Modbus functions via using a DFB user function block [DAT_EXCHG] (1)

(1) DFB user function block [DAT_EXCHG] can be used to send Modbus/TCP requests on Ethernet network.

References					
	I/O capacity	Memory capacity	Integrated communication ports	Reference	Masse kg
				Standard processor with integrated serial link BMX P34 10, 2 racks	
 BMX P34 1000/2000	512 discrete I/O 128 E/S analog I/O 20 application-specific channels	2,048 Kb integrated	Modbus serial link	BMX P34 1000	0.200
	Performance processors with integrated serial link BMX P34 20, 4 racks				
 BMX P34 2020	1024 discrete I/O 256 E/S analog I/O 36 application-specific channels	4,096 Kb integrated	Modbus serial link	BMX P34 2000	0.200
			Modbus serial link CANopen bus	BMX P34 2010	0.210
			Modbus serial link Ethernet Modbus/TCP network	BMX P34 2020	0.205

Serial link cabling system, see pages 3/46 and 3/47.



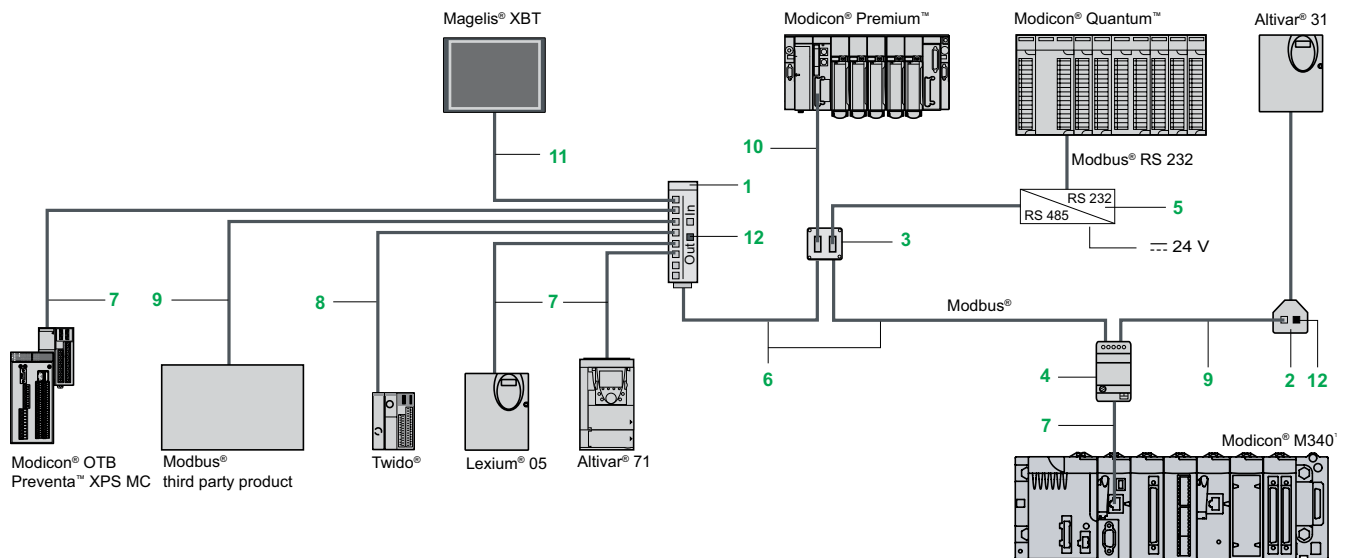

Modicon® M340™ automation platform

Modbus® and character mode serial link
Cabling system

Cabling system



Extension and adaptation elements for RS 485 serial link

	Designation	Description	No.	Length	Unit reference	Weight kg
	Modbus® splitter box	- 1 x screw terminal block for trunk cable: D(A), D(B), \pm and 0V - 8 x RJ45 connectors for derivation - 2 x RJ45 connectors for link in serial LU9 GC3 splitter Mounting on 35 mm DIN rail	1	-	LU9 GC3	0.500
	T-junction boxes dedicated for Altivar and Lexium	- 2 x RJ45 connectors - 1 x integrated cable with RJ45 connector	2	0.3 m 1 m	VW3 A8 306 TF03 VW3 A8 306 TF10	0.190 0.210
	Passive T-junction box	- Tap-off point, extension of trunk cable - Line termination adaptor	-	-	TSX SCA 50	0.520
	Passive 2-channel subscriber socket, 2 x	- 2-channel tap-off point and extension of trunk cable - Address coding - Line termination adaptor	3	-	TSX SCA 62	0.570
	T-junction box Screw terminals for main cable. 1 x RJ45 connector for derivation	- Insulation of the RS 485 serial line - Line termination adaptation (R = 120 Ω , C = 1 nF) - Line pre-polarized (2 x R = 620 Ω) (1) 24 V \pm power (2) Mounting on 35 mm DIN rail	4	-	TWD XCA ISO	0.100
	T-junction box 3 x RJ45 connectors	- Line termination adaptation (R = 120 Ω , C = 1 nF) - Line pre-polarized (2 x R = 620 Ω) (1) Mounting on 35 mm DIN rail	-	-	TWD XCA T3RJ	0.080
	Modbus / Bluetooth® adaptor	- 1 x Bluetooth® adaptor (10 m range, class 2) with 1 x RJ45 connector, - 1 x 0.1 m long cordset for PowerSuite with 2 x RJ45 connectors, - 1 x 0.1 m long cordset for TwidoSuite with 1 x RJ45 connector and 1 x mini-DIN connector, - 1 x RJ45/SUB-D male 9-way adaptor for Altivar speed drives	-	-	VW3 A8114	0.155
	RS 232C/RS 485 line adaptor without modem signals	24 V \pm /20 mA power supply, 19.2 kbit/s Mounting on 35 mm DIN rail	5	-	XGS Z24	0.100
	Line terminator	For RJ45 connector (R = 120 W, C = 1 nF)	12	Sold in lots of 2	VW3 A8 306RC	0.200

(1) Polarized terminals requires to connection of Twido® controller master.
(2) 24 V \pm power supply external or thru the serial port integrated to Modicon® M340™ processors.

Cables and connecting cordsets for RS 485 serial link

Designation	Description	No.	Length	Unit reference	Weight kg
RS 485 double shielded twisted pair trunk cables	Modbus® serial link, supplied without connector	6	100 m	TSX CSA 100	5.680
			200 m	TSX CSA 200	10.920
			500 m	TSX CSA 500	30.000
Modbus RS 485 cables	2 x RJ45 connectors	7	0.3 m	VW3 A8 306 R03	0.030
			1 m	VW3 A8 306 R10	0.050
			3 m	VW3 A8 306 R30	0.150
	1 x RJ45 connector and 1 x 15-way SUB-D connector	–	3 m	VW3 A8 306	0.150
	1 x mini-DIN connector for Twido controller and 1 x RJ45 connector	4	0.3 m	TWD XCA RJ003	0.040
1 m			TWD XCA RJ010	0.090	
3 m			TWD XCA RJ030	0.16	
	1 x RJ45 connector and 1 end with flying leads	5	3 m	VW3 A8 306 D30	0.150
	1 x miniature connector and 1 x 15-way SUB-D connector	9	3 m	TSX SCP CM 4530	0.180
Cordsets for Magelis® XBT display and terminal	1 x RJ45 connector and 1 x 25-way SUB-D connector for: - XBT N200/N400/NU400 - XBT R410/411 - XBT GT2...GT7 (COM1 port) (1)	11	2.5 m	XBT Z938	0.210
	2 x RJ45 connectors for : - XBT GT1 (COM1 port) - XBT GT2...GT7 (COM2 port)	11	3 m	VW3 A8 306 R30	0.150

Connecting cordsets for RS 232 serial link

Designation	Description	Length	Unit reference	Weight kg
Cordset for Data Terminal Equipment (DTE: printer...)	Serial link for Data Terminal Equipment (DTE) (2) 1 x RJ45 connector and 1 x 9-way SUB-D female connector	3 m	TCS MCN 3M4F3C2	0.150
Cordset for Data Communication Equipment (DCE: modem, converter...)	Serial link for point-to-point equipment (DCE) 1 x RJ45 connector and 1 x 9-way SUB-D male connector	3 m	TCS MCN 3M4M3S2	0.150

(1) Must be associated with an **XBT ZG909** adaptor.

(2) If the DTE is equipped with a 25-way SUB-D connector, a 25-way female / 9-way male SUB-D **TSX CTC 07** adaptor can be ordered.

4.1 - Unity™ software

Unity software selection guide 4/2

- Unity Pro software
 - Introduction, setup 4/6
 - Software structure 4/11
 - 5 IEC languages 4/14
 - Functions 4/20
 - Unity Pro XLS specific functions
 (Safety Modicon® Quantum™ PLC) 4/30
 - References 4/35
- Unity MFB motion control see 2/52
- Unity EFB Toolkit software 4/40
- Unity SFC View software 4/42
- Unity Dif application comparison software 4/46
- Unity Loader software 4/48
- Programmable process control see 2/34

4.2 - Vijeo® Citect® supervisory software

- Introduction 4/50
- Architectures 4/52
- References 4/54

4.3 - OPC® data server software

- Introduction 4/60
- Architectures supported 4/61
- Setup 4/63
- Functions 4/64
- References 4/65



Unity™ Pro programming software for Modicon® M340™ M, Premium™ P, Atrium™ A, Quantum™ Q and SIL3 Quantum™ S platforms



4

IEC 61131-3 languages	Instruction List (IL)	M	M - A - P
	Ladder (LD)	M	M - A - P
	Structured Text (ST)	M	M - A - P
	Function Block Diagram (FBD)	M	M - A - P
	Sequential Function Chart (SFC)/Grafcet™	M	M - A - P
Programming services	Multitask programming (Master, fast and event-triggered)	M	M - A - P
	Multitask programming (Master, fast and event-triggered)		
	Functional view and function modules	M	M - A - P
	DFB editor and instances	M	M - A - P
	DDT compound data editor	M	M - A - P
	Data structure instances and tables	M	M - A - P
	EF libraries and EFBs	M	M - A - P
	User-definable control loops		A (TSX PCI 2●) - P (TSX P57 2●)
	Programmable control loops (with process control function block library)	M	M - A - P
	Safety function block libraries		
	Motion function block (MFB) libraries	M	M - A - P
	Hot Standby PLC redundancy system		P (TSX H57 24M)
	System diagnostics	M	M - A - P
	Application diagnostics	M	M - A - P
	Diagnostics with location of detected error source	M	M - A - P
Debugging and display services	PLC simulator	M	M - A - P
	Hypertext link animations in graphic languages	M	M - A - P
	Step by step execution, breakpoint	M	M - A - P
	Watchpoint	M	M - A - P
	Operator screens	M	M - A - P
	Dagnostic viewer	M	M - A - P
Other services	Creation of hyperlinks	M	M - A - P
	XML import/export	M	M - A - P
	Application converters (Concept™, PL7™)		M - A - P
	Utilities for updating PLC operating systems	M	M - A - P
	Communication drivers for Windows 2000®/ Windows XP®	M	M - A - P
Unity™ Pro servers - Openness			
UDE support OFS exchanges	Dynamic exchange with 3rd party tools, OFS		
	Static exchange via XML/XVM export files	M	M - A - P
Compatible Modicon® platforms	Modicon® M340™ processors M	BMX P34 1000 BMX P34 20●0	BMX P34 1000 BMX P34 20●0/20●02
	Atrium™ slot-PLCs A	-	TSX PCI 57204M
	Premium™ CPUs P	-	TSX P57 C● 0244/0244M TSX P57 104/1634/154M TSX P57 204/2634/254M TSX H57 24M
	Quantum™ CPUs Q	-	-
	SIL3 Quantum™ CPUs S	-	-
Software name	Unity™ Pro Small	Unity™ Pro Medium	
Unity™ Pro software type	UNY SPU SF● CD41	UNY SPU MF● CD41	
Pages	4/36		

Unity™ Pro programming software for Modicon® M340™ M, Premium™ P, Atrium™ A, Quantum™ Q and SIL3 Quantum™ S platforms



M - A - P - Q	M - A - P - Q	M - A - P - Q
M - A - P - Q	M - A - P - Q	M - A - P - Q - S
M - A - P - Q	M - A - P - Q	M - A - P - Q
M - A - P - Q	M - A - P - Q	M - A - P - Q - S
M - A - P - Q	M - A - P - Q	M - A - P - Q
M - A - P - Q	M - A - P - Q	M - A - P - Q
	P (TSX P57 5●) - Q (140 CPU 651/671)	P (TSX P57 5●) - Q (140 CPU 651/671)
M - A - P - Q	M - A - P - Q	M - A - P - Q - S
M - A - P - Q	M - A - P - Q	M - A - P - Q
M - A - P - Q	M - A - P - Q	M - A - P - Q
M - A - P - Q	M - A - P - Q	M - A - P - Q
M - A - P - Q	M - A - P - Q	M - A - P - Q
A (TSX PCI 2●/3●) - P (TSX P57 2●/3●/4●)	P (TSX P57 2●/3●/4●/5●)	P (TSX P57 2●/3●/4●/5●)
M - A - P - Q	M - A - P - Q	M - A - P - Q
		S
M - A - P	M - A - P	M - A - P
P (TSX H57 24/44M)	P (TSX H57 24/44M) - Q (140 CPU 67 160)	P (TSX H57 24/44M) - Q (140 CPU 67 160) - S
M - A - P - Q	M - A - P - Q	M - A - P - Q - S
M - A - P - Q	M - A - P - Q	M - A - P - Q
M - A - P - Q	M - A - P - Q	M - A - P - Q
M - A - P - Q	M - A - P - Q	M - A - P - Q - S
M - A - P - Q	M - A - P - Q	M - A - P - Q - S
M - A - P - Q	M - A - P - Q	M - A - P - Q - S
M - A - P - Q	M - A - P - Q	M - A - P - Q - S
M - A - P - Q	M - A - P - Q	M - A - P - Q - S
M - A - P - Q	M - A - P - Q	M - A - P - Q - S
M - A - P - Q	M - A - P - Q	M - A - P - Q - S
M - A - P - Q	M - A - P - Q	M - A - P - Q - S
M - A - P - Q	M - A - P - Q	M - A - P - Q
M - A - P - Q	M - A - P - Q	M - A - P - Q
M - A - P - Q	M - A - P - Q	M - A - P - Q - S
	M - A - P - Q	M - A - P - Q - S
	M - A - P - Q	M - A - P - Q - S
M - A - P - Q	M - A - P - Q	M - A - P - Q - S

BMX P34 1000 BMX P34 20●0/20●02	BMX P34 1000 BMX P34 20●0/20●02	BMX P34 1000 BMX P34 20●0/20●02
TSX PCI 57204M TSX PCI 57354M	TSX PCI 57204M TSX PCI 57354M	TSX PCI 57204M TSX PCI 57354M
TSX P57 C● 0244/0244M TSX P57 104/1634/154M TSX P57 204/2634/254M TSX P57 304/3634/354M TSX P57 4634/454M TSX H57 24/44M	TSX P57 C● 0244/0244M TSX P57 104/1634/154M TSX P57 204/2634/254M TSX P57 304/3634/354M TSX P57 4634/454M TSX P57 5634/554M TSX P57 6634M TSX H57 24/44M	TSX P57 C● 0244/0244M TSX P57 104/1634/154M TSX P57 204/2634/254M TSX P57 304/3634/354M TSX P57 4634/454M TSX P57 5634/554M TSX P57 6634M TSX H57 24/44M
140 CPU 311 10 140 CPU 434 12U 140 CPU 534 14U	140 CPU 311 10 140 CPU 434 12U 140 CPU 534 14U	140 CPU 311 10 140 CPU 434 12U 140 CPU 534 14U 140 CPU 651 50/60 140 CPU 652 60 140 CPU 671 60
-	-	140 CPU 651 60S 140 CPU 671 60S

Unity™ Pro Large UNY SPU LF● CD41	Unity™ Pro Extra Large UNY SPU EF● CD41	Unity™ Pro XLS UNY SPU XF● CD41
--	--	--

Modicon® M340™ automation platform

Unity™ software

	<p>Unity™ EFB Toolkit Software for developing EFs/EFBs in C language</p>	<p>Unity™ SFC View Application diagnostics and monitoring software</p>
		
<p>Service</p>	<p>Enhancement of EF and EFB libraries:</p> <ul style="list-style-type: none"> ■ Creation of families ■ Development of functions in C language ■ Access to all data and variable types ■ Debugging functions (step by step, breakpoint) ■ Use of functions created in all languages <p>Supplied with:</p> <ul style="list-style-type: none"> ■ Microsoft® Visual C++® ■ GNU source code and compiler 	<p>Microsoft® ActiveX® control component for monitoring and diagnostics of chart status (SFC or Grafcet™) in sequential applications:</p> <ul style="list-style-type: none"> ■ Overview of charts and detailed views ■ Can be integrated in human/machine interface (HMI) applications ■ Access to PLC data via OFS (<i>OPC Factory Serveur</i>) <p>Includes EFB function block library for Unity™ Pro (for Modicon® M340™, Premium™, Atrium™ and Quantum™ CPUs)</p>
<p>Compatibility</p>	<p>Software: Unity Pro Small, Medium, Large and Extra Large</p> <p>CPUs:</p> <ul style="list-style-type: none"> ■ Modicon M340 ■ Atrium slot-PLCs ■ Premium Unity ■ Quantum Unity 	<p>Software: Unity Pro Extra Large</p> <p>CPUs:</p> <ul style="list-style-type: none"> ■ Modicon M340 ■ Atrium slot-PLCs ■ Premium Unity ■ Quantum Unity
<p>Software name Unity™ Pro software type Pages</p>	<p>Unity™ EFB Toolkit UNY SPU ZFU CD30E 4/41</p>	<p>Unity™ SFC View UNY SDU MFU CD20 4/45</p>

Comparison software for Unity™ Pro applications	Software for loading application and firmware components	Software for designing and generating batch/process applications	Pack for developing specific solutions
---	--	--	--



<p>Automatic comparison of two Modicon® M340™, Premium™, Atrium™ and Quantum™ applications with identification of the differences.</p>	<p>Simple and easy to use software to upgrade a Modicon M340 CPU when the user doesn't need to display/modify the application.</p> <p>Upload/download:</p> <ul style="list-style-type: none"> ■ CPU and Ethernet module firmware ■ PLC project, including: <ul style="list-style-type: none"> □ Program □ Located and unlocated data □ User files and user web pages 	<p>UAG specialist software for designing and generating batch/process applications in a "Collaborative Automation" environment.</p> <p>It provides the unique project database:</p> <ul style="list-style-type: none"> ■ Process and control (PLCs) ■ HMI user interface (Magelis) ■ SCADA (Vijeo Citect) <p>Based around re-usable objects (PID, valves, etc.) and complying with standard ISA S88, UAG generates the PLC code and the elements required for the HMI system.</p> <p>Complies with the GAMP standard (<i>Good Automation Manufacturing Practice</i>).</p>	<p>Specialist software for developing customized solutions (for example, interfaces with an electrical CAD system, automatic application generator, etc.):</p> <ul style="list-style-type: none"> ■ Access to Unity™ Pro object servers ■ Reserved for IT development engineers using Visual Basic or C++
--	--	--	---

<p>Software: Unity Pro Extra Large</p> <p>CPUs:</p> <ul style="list-style-type: none"> ■ Modicon M340 ■ Atrium slot-PLCs ■ Premium Unity ■ Quantum Unity 	<p>Software: Unity Pro Small, Medium, Large and Extra Large</p> <p>CPUs:</p> <ul style="list-style-type: none"> ■ Modicon M340 ■ Premium Unity ■ Quantum Unity 	<p>Software: Unity Pro Extra Large</p> <p>CPUs:</p> <ul style="list-style-type: none"> ■ Premium Unity: <ul style="list-style-type: none"> □ TSX P57 4634/454M □ TSX P57 5634/554M □ TSX P57 6634M ■ Quantum Unity 	<p>Software: Unity Pro Extra Large</p> <p>CPUs:</p> <ul style="list-style-type: none"> ■ Modicon M340 ■ Atrium slot-PLCs ■ Premium Unity ■ Quantum Unity
--	---	--	--

Unity™ Dif	Unity™ Loader	Unity™ Application Generator	Unity™ Developer's Edition
UNY SDU DFL CD21	UNY SMU ZU CD21	UNY SEW LF• CD30	UNY UDE VFU CD21E
4/47	4/49	–	4/34

User interface

Unity™ Pro's welcome screen provides access to available tools in a user-friendly format that has been redesigned on the basis of feedback received from users of Concept™ and PL7™ Junior/Pro application design software.

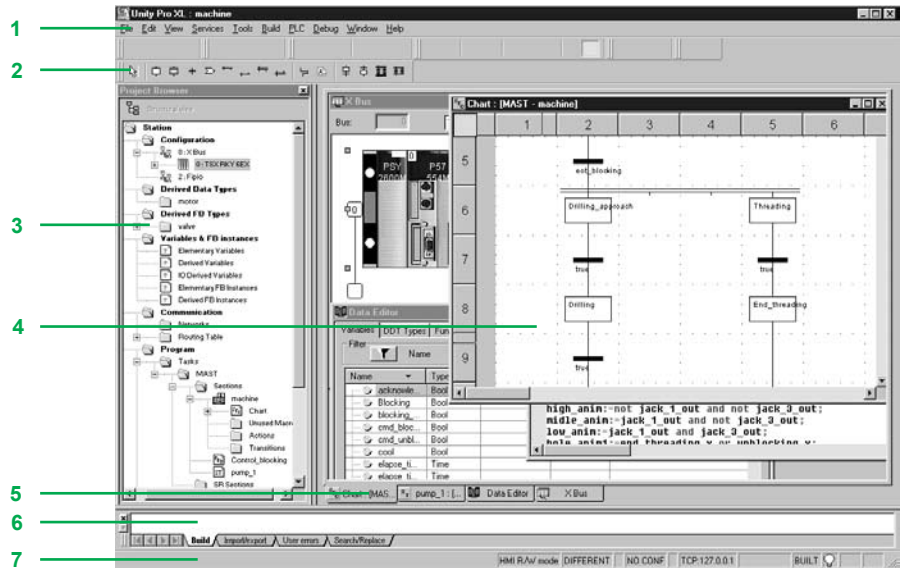

4

This welcome screen consists of a general view made up of a number of windows and toolbars that can be arranged as required on the screen:

- 1 Menu bar where functions can be accessed
- 2 Toolbar consisting of icons where the most frequently used functions can be accessed
- 3 Application browser that can be used to browse the application based on a conventional and/or a functional view
- 4 Editor windows that can be used to view a number of editors at the same time (configuration editor, Structured Text/Ladder etc. language editors, data editor)
- 5 Tabs for direct access to editor windows
- 6 Information window with tabs (User Errors, Import/Export, Search/Replace, etc.)
- 7 Status bar

Accessing functions

Functions can be accessed via drop-down menus from the menu bar. The toolbar icons provide faster access to the most frequently used functions. This toolbar is displayed by default, but it can be customized to meet the requirements associated with the various uses of Unity Pro software and is divided into three groups:

- Main toolbars are always visible
- Contextual toolbar is displayed when the corresponding editor is selected
- Toolbar with zoom functions (in and out), full-screen view for editor window

They are classified according to the category of functions available:

- File management (New Project, Open, Save, Print)
- Edit (Undo, Redo, Confirm, Go To)
- Application services (Analyze Project, Build Project, Browse, Find, Access Library)
- Automation platform operating mode (Upload/Download Project, Online/Offline, Run/Stop, Animate, PLC/Simulation Mode)
- Debug mode (Set/Remove Breakpoint, etc.)
- Window display (Cascade, Horizontal, Vertical)
- Online help (non-contextual or contextual)



"File/Edit" toolbar

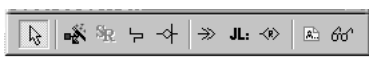

FBD language editor contextual toolbar



"PLC" toolbar for debug mode



Toolbar with zoom (in and out)

Project navigator

The project browser can be used:

- To display the content of a Modicon® M340™, Atrium™, Premium™, or Quantum™ PLC project
- To move between the different components of the application (configuration, program, variables, communication, DFB user function blocks, DDT derived function blocks) created by the user



The project can be displayed using two view types:

- **Structural view** provides an overall view of the various components of the application. This reintroduction provides a view of the order in which the program sections are processed in the PLC.
- **Functional view** provides a view of the project based on specific function modules. This reintroduction provides a breakdown according to consistent functions in relation to the process to be controlled. These two view types are available at any time and can be displayed separately or at the same time (with horizontal or vertical windows) by clicking on the icons on the toolbar.

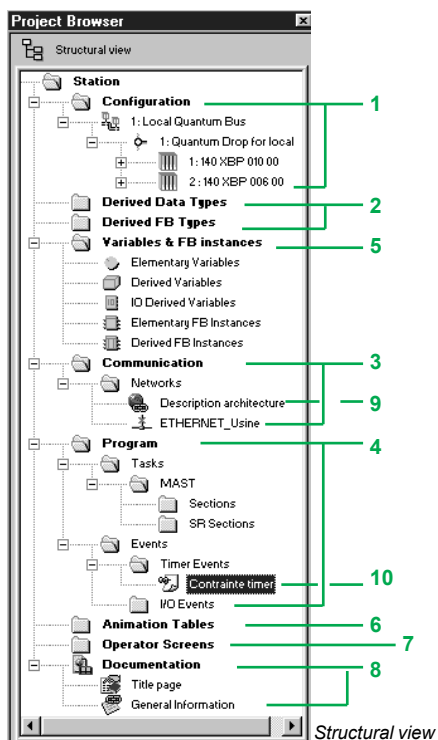

Structural view

This conventional view allows you to access the different components of the application (configuration, programming, function blocks, debugging, etc.) via the application browser.

The browser gives an overall view of the program and offers fast access to all application components.

- 1 Configuration editor
- 2 DFB (user function block) and DDT (Derived Data Type) editors
- 3 Communication networks editor
- 4 Program editor
- 5 Variables editor
- 6 Animation tables editor
- 7 Runtime screens editor
- 8 Documentation editor

From any level in the tree structure, you can:

- 9 Create a hyperlink to a comment or description
 - 10 Create a directory for storing hyperlinks used to access a set of user folders
- From this level, it is also possible to zoom in and only view the details for a component on this level.

Functional view

Unity™ Pro software applications support the creation of an application structure for Modicon® M340™, Atrium™, Premium™ and Quantum™ platforms based on function modules comprised of:

- Sections (program code)
- Animation tables
- Runtime screens

The designer can define a multi-level tree structure for the application, independently of the multitask structure of the PLC.

Program sections written in Ladder (LD), Structured Text (ST), Instruction List (IL), Function Block Diagram (FBD), or Sequential Function Chart (SFC) language can be associated with each level, along with animation tables and runtime screens

Exporting/importing function modules

All or part of the tree structure can be exported to functional modules. In this case, program sections on the various module levels are exported.

Utilities make it easy to reuse these modules in new applications by means of data and module name reassignment services.

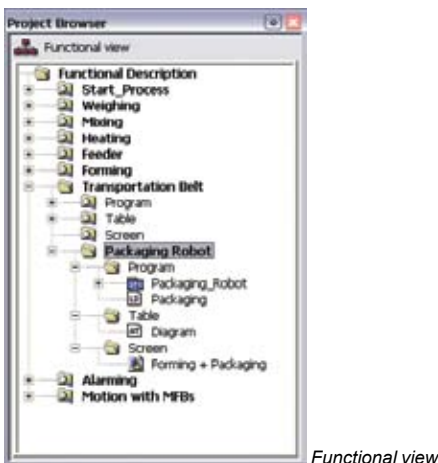

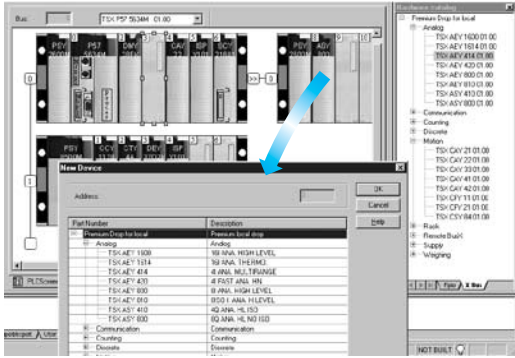

Hardware configuration

Configuration editor

Hardware configuration

The first step when creating an automation project based on a Modicon® M340™, Atrium™, Premium™, or Quantum™ platform is to select the processor. A rack and power supply are defined by default.

The configuration editor supports the intuitive and graphics-based modification and extension of this configuration with the following elements:

- Racks, power supply
- PCMCIA memory or communication cards (Atrium/Premium) on the processor
- Discrete I/O, analog I/O, or application-specific modules

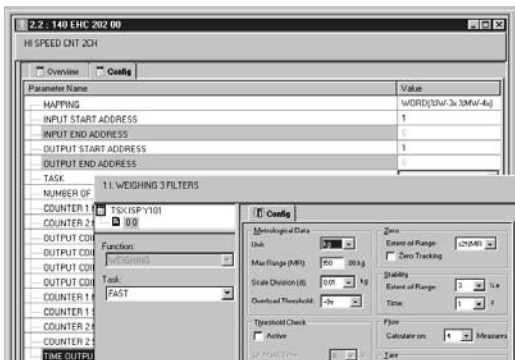

I/O module parameter setting

Configuration and parameter settings for I/O and application-specific modules

From the configuration screen for Modicon M340, Atrium, Premium, or Quantum racks, the parameters screen displayed for a specific module can be used to define the operating specifications and parameters for the selected application, for example:

- Filter values for discrete I/O
- Voltage or current range for analog I/O
- Threshold counter values
- Trajectory of axes for position control
- Weigher calibration for weighing
- Transmission speed for communication
- Presymbolization for variables associated with modules

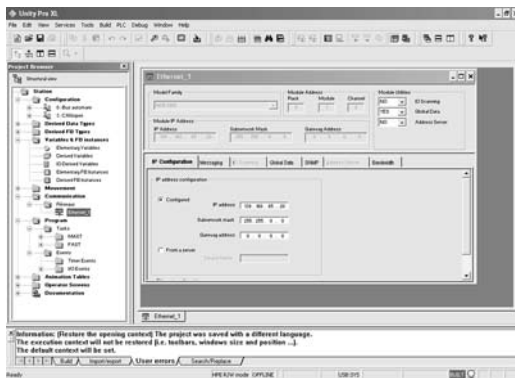

"Communication" folder with 2 networks declared

Configuration and parameter settings for communication networks

The "Communication" folder in the structural view can be used to define the list of networks connected to the PLC station. Then, the parameters for elements required for networks to function correctly can be set by:

- Creating a logical network to which comments can be associated
 - Configuring a logical network defining the various associated network services
- Once the network module has been created in the configuration, it must then be associated with one of the logical networks. Ethernet Modbus®/TCP, Modbus Plus™, and Fipway® network modules are configured in this way.

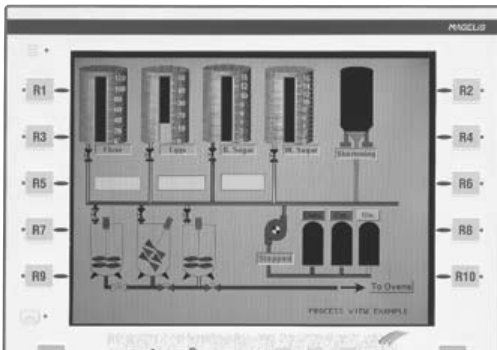

Power supply requirements analysis

Configuration editor (continued)

Configuration check

The following information can be accessed at any time during configuration:

- The power consumption statistics for the power supply in each of the racks in the PLC configuration, for the different voltages provided by each of these power supplies
- The number of inputs/outputs configured (with Modicon® M340™, Atrium™, or Premium™ platform)



Graphical configuration of devices on CANopen bus

Configuration of CANopen devices

In the same way as for in-rack modules, the configuration of devices on CANopen through a Modicon M340 processor is fully integrated into the Configuration Editor.

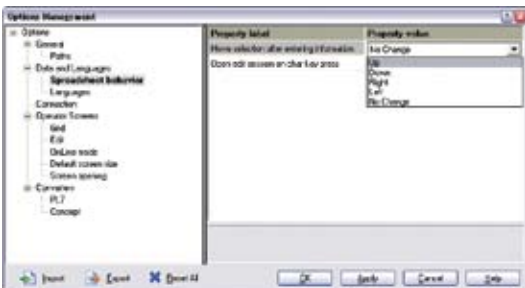

"Data & Languages" tab in the workstation options

Workstation and project configuration

Unity™ Pro can be used to configure both the working environment (workstation options) and the content of the project.

It is also possible to configure the toolbars and to run third-party applications from Unity Pro.

In addition, users can choose the working language from the list of languages selected when the software was installed.

Workstation options

The workstation options cover the specifications specific to a given workstation. They are applied when Unity Pro is used to develop any project on that station.

The following elements can be configured:

- The way information is edited and presented in the project being developed (for example: whether or not coils are positioned in the last column of the editor, or the position of the cursor after confirmation of the information entered)
- The application conversion strategy from PL7™, Concept™ IEC, and LL984 language
- The function library path
- The opening mode for Unity Pro (either programming or run mode)

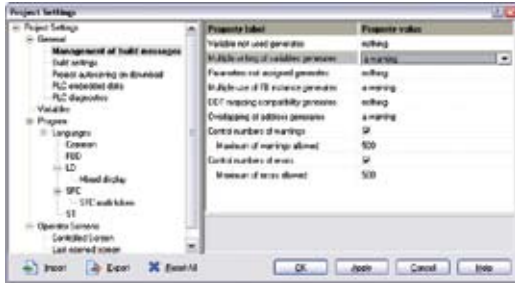

"Language extensions" tab in the workstation option

Workstation and project configuration (continued)

Project options

In contrast to the workstation options, project options cover specifications that have a direct impact on the programming and execution capacities offered by the program in the PLC. They are saved in the application and are attached to the project. They can be modified during the course of the project.

Project option configuration comprises the following elements:

- Project generation with all or part of the information enabling the project to be retrieved on a new terminal
- Use of diagnostic functions and language for messages
- Warnings generated during project analysis: overlapping of addresses, unused variables, etc.
- Language extension: If none of the boxes are checked, the program is compliant with IEC 61131-3. Extensions are possible in the five Unity™ Pro languages.
- Access management to runtime screens in online mode.

4



User-created toolbar containing all the debugging tools

Other possible options

Users can create their own toolbars by reusing the default icons provided on the toolbars.



Menu for adding and deleting tool access from Unity™ Pro

It is also possible to enhance the main Unity Pro menu bar by adding direct links to other software tools.

A utility in the Unity Pro program group can be used to change the working language. The change will take effect the next time the software is launched. Six languages are available: English, German, Spanish, French, Italian, and Chinese.

Software structure

The Modicon® M340™, Atrium™, Premium™, and Quantum™ platforms implemented by Unity™ Pro software support two types of application structure:

- **Single-task:** This is the more simple default structure that only executes a master task.
- **Multitask:** This structure is more suitable for high-performance, real-time events. It consists of a master task, a fast task, periodic tasks and high-priority event triggered tasks.

The master, fast, and periodic tasks are made up of sections and subroutines. These sections and subroutines can be programmed in any of the following languages: Structured Text (ST), Instruction List (IL), Ladder (LD) or Function Block Diagram (FBD). The event-triggered tasks use the same languages. Sequential Function Chart (SFC) or Grafcet language is reserved for master task sections.

The table below lists the possible program tasks for Modicon M340, Atrium, Premium, and Quantum type processors, respectively.

Platform	Modicon® M340™		Premium™			Atrium™	Quantum™	
	BMX P34 1000	BMX P34 20●0	TSX P 57 0244M TSX P 57 1●4M	TSX P 57 2●(3)4M TSX P 57 3●(3)4M TSX P 57 4●(3)4M	TSX P 57 554M TSX P 57 5634M TSX P 57 6634M	TSX PCI 57 204 M TSX PCI 57 454 M	140 CPU 31110 140 CPU 434 12U	140 CPU 651 ●0 140 CPU 671 60
Cyclic or periodic master task	Yes	Yes	Yes	Yes	Yes	Yes	Yes	Yes
Periodic fast task	Yes	Yes	Yes	Yes	Yes	Yes	Yes	Yes
Periodic auxiliary tasks	–	–	–	–	4	–	–	4
Event-triggered tasks								
From modules	32	64	32	64	128	64	64	128
From timers	32	64	–	–	32	–	16	32
Total	32	64	32	64	128	64	64	128

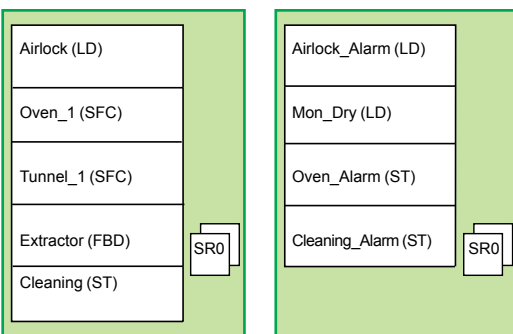

Master task

Fast task

Structure, modular, and portable programming

The tasks of a Unity Pro program for Modicon M340, Atrium, Premium, or Quantum platforms are composed of several parts called sections and subroutines. Each of these sections can be programmed in the most appropriate language for the process to be executed.

Such division into sections enables a structured program to be created and program modules to be generated or added with ease.

Subroutines can be called from any section of the task where they are located or from other subroutines in the same task.

Compatibility of languages compliant with IEC standard 61131-3: Unity Pro software can be configured (Tools/Project Settings/Language Extensions menu) to help ensure that applications generated are compliant with IEC standard 61131-3. Furthermore, as long as you use only the standard instruction libraries, you will be able to reuse programs created in this way on any Modicon M340, Atrium, Premium or Quantum platform.

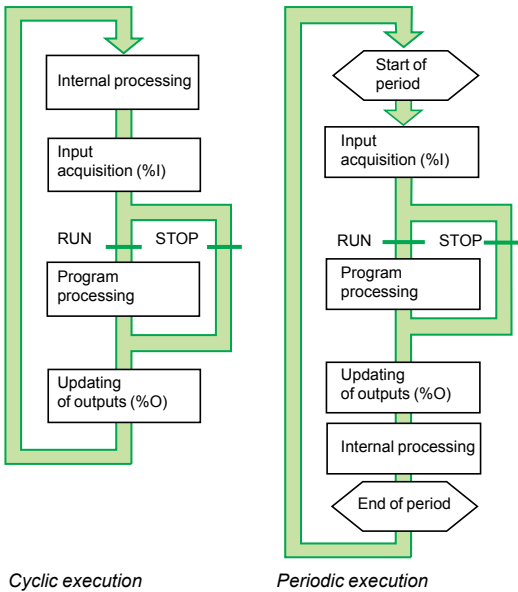

Cyclic execution

Periodic execution

4

Single-task software structure

Two types of cyclic execution are supported:

- Normal cyclic execution. This is the default option.
- Periodic execution. This type of execution, as well as the period, are selected by the user during programming when the task parameters are set (Mast task).

Normal execution (cyclic)

At the end of each scan, the PLC system launches a new scan. The execution time of each scan is monitored by a software watchdog whose value is defined by the user (1,500 ms, maximum).

In the event of an overrun, a detected fault will occur that will cause:

- The scan to stop immediately (STOP)
- A detected fault state to be displayed on the front panel of the processor
- The alarm relay for the main rack power supply to be set to 0

Periodic execution

A new scan is executed at the end of each period. The execution time of the scan must be less than the time of the period defined (255 ms, maximum). In the event of an overrun, the latter is stored in a system bit (%S19) that can be reset to 0 by the user (via the program or terminal).

A software watch can be configured by the user (1,500 ms, maximum) to monitor the scan time. In the event of an overrun, a detected execution fault is indicated (see Normal execution). The scan execution times (the last scan, the longest scan, and the shortest scan) are stored in system words %SW 30/31/32.

Multitask software structure

Modicon® M340™, Atrium™, Premium™, and Quantum™ platforms support a multitask structure comprised of:

- 1 master task (divided into several sections programmed in ST, IL, LD, FBD, and SFC languages)
- 1 fast task (divided into sections)
- 0 to 4 auxiliary tasks (divided into sections) (1).
- 1 or more event-triggered tasks (only one section per task). These tasks are independent and executed in parallel, with the PLC processor managing their execution priority. When an event occurs, or at the start of the fast task scan:
- If any lower-priority tasks are currently being executed, they are suspended.
- The event-triggered task or fast task is executed.
- The interrupted task resumes once execution of the priority task has been completed.

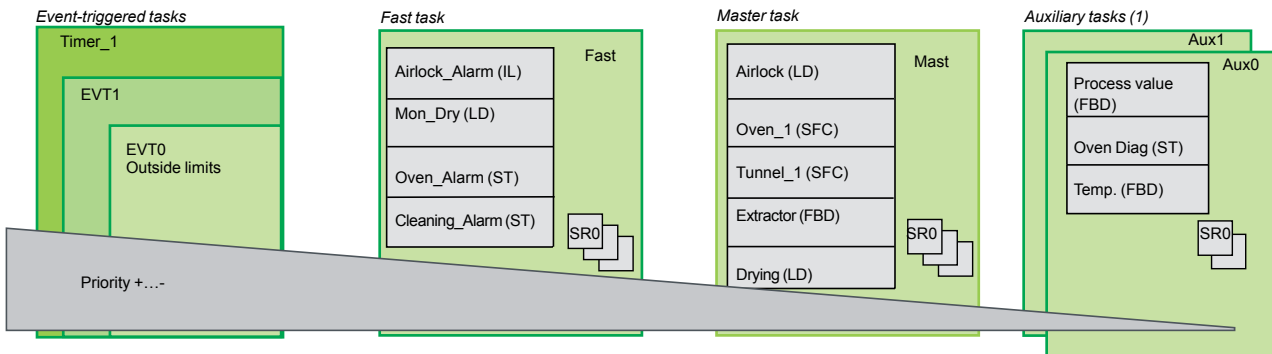

This structure optimizes the way processing power is employed and can be used to structure the application and simplify design and debugging, as each task can be written and debugged independently of the others.

(1) Tasks reserved for Premium TSX P57 5•4M/6634M and Quantum 140 CPU 651 •0/67160 high-end processors.

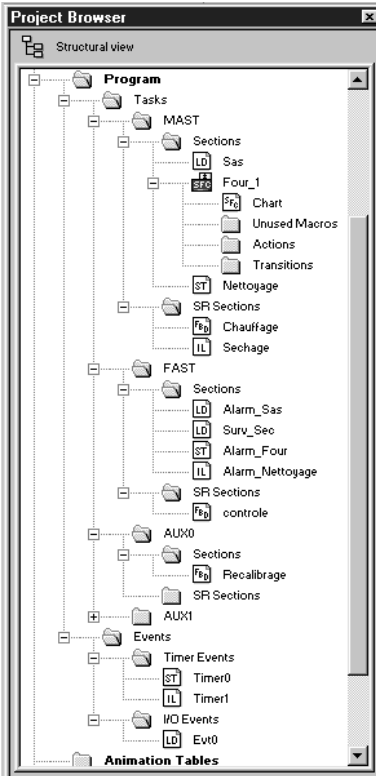

Application browser

Multitask software structure (continued)

Master task

This task can be periodic or cyclic and executes the main program. It is activated systematically. Each of its component sections and subroutines can be programmed in Ladder (LD), Function Block Diagram (FBD), Structured Text (ST), or Instruction List (IL) language. Several sections of the master task can be programmed in Sequential Function Chart (SFC) or Grafcet™ language.

Fast task

This task has a higher priority than the master task and is periodic to allow time for tasks with lower priorities to be executed. It should be used when fast periodic changes in discrete inputs need to be monitored and taken into account. The execution of the master task (lower priority) is suspended while the fast task is being executed. Processing operations in this task must be as short as possible in order to avoid adversely affecting master task processing operations. Each subroutine or section of an auxiliary task can be programmed in Instruction List, Structured Text, Ladder, or Function Block Diagram language (IL, ST, LD, or FBD).

Auxiliary tasks

These tasks are available with the Premium™ and Quantum™ TSX P57 5•4M/6634M and 140 CPU 651 •0/652 60/671 60 high-end processors and are intended for slower processing operations, such as measurement, process control, HMI, application diagnostics, etc.

Periodic type auxiliary tasks have the lowest priority and are executed once the higher-priority periodic tasks (master and fast) have completed their scan. Each subroutine or section of an auxiliary task can be programmed in Instruction List, Structured Text, Ladder, or Function Block Diagram language (IL, ST, LD, or FBD).

Event-triggered tasks

Unlike the tasks described above, these tasks are not linked to one period.

The asynchronous execution of these tasks is triggered by:

An event from certain application-specific modules (for example: overrun of a counter threshold, change of state of a discrete input)

An event from the event timers.

These tasks are processed with priority over the other tasks and are thus suitable for processing requiring very short response times in comparison to the arrival of the event.

Modicon® M340™, Atrium™, Premium™, and Quantum™ platforms have 3 priority levels (these are, in descending order, EVT0 module event, EVTi module events, and Timeri timer events).

These tasks, each comprised of a single section, can be programmed in Instruction List, Structured Text, Ladder, or Function Block Diagram language (IL, ST, LD or FBD).

Assignment of I/O channels to tasks

The master, fast, and event-triggered tasks read (at the start of the scan) and write to (at the end of the scan) the inputs/outputs assigned to them. By default, they are assigned to the master task.

For the Quantum platform, the remote inputs/outputs (RIO) are assigned only to the master task (these assignments can be made per station or for each of the component sections of the task); the distributed inputs/outputs (DIO) are assigned to the master task (with no assignment to its component task).

For event-triggered tasks, it is possible to assign input/output channels (1) other than those relating to the event. Exchanges are then performed implicitly at the start of processing for inputs and at the end of processing for outputs.

(1) These channel assignments are made per I/O modules for Quantum and per channel for Atrium/Premium inputs/outputs.

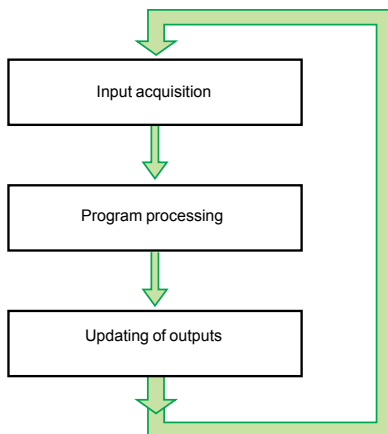

Program execution

The five IEC languages

The five graphical or textual languages available in Unity™ Pro are used for programming Modicon® M340™, Atrium™, Premium™, and Quantum™ automation platforms.

The 3 graphical languages are:

- Ladder (LD)
- Function Block Diagram (FBD)
- Sequential Function Chart (SFC) or Grafcet™

The 2 textual languages are:

- Structured Text (ST)
- Instruction List (IL)

For these 5 languages, you can use the standard set of instructions compliant with IEC standard 61131-3 to create applications that can be transferred from one platform to another. Unity Pro software also provides extensions to this standard set of instructions. As they are specific to Modicon M340, Atrium/Premium, and Quantum PLCs, these extensions support the development of more complex applications to maximize the potential of the specific features of each of these platforms.

Functionalities common to the five language editors

The editors for each of the 5 languages provide a number of common tools used for writing, reading, and analyzing programs in a user-friendly manner:

■ The text editors for Instruction List (IL) and Structured Text (ST) languages feature:

- Text entry in insert or overwrite mode
- The use of dialog boxes for the assisted entry of variables, functions, function blocks, or assignment instructions
- Checks on data entry to detect syntax or semantics errors. The results of these checks are indicated by red “wavy” underlining or by a change in the color of the text containing the incorrect information.
- A set of colors that facilitate reading by distinguishing text (black) from operators (red), language key words (blue) and program comments (green)

■ The graphics editors for Ladder (LD), Function Block Diagram (FBD) and Sequential Function Chart (SFC) languages feature:

- A set of graphics elements for direct access to the various graphic symbols in the language via the mouse or keyboard
- A pop-up menu that can be accessed simply by right-clicking the mouse

■ Unlimited number and length of comments. These comments can be positioned as text objects in any cell (graphical languages) or at any point in expressions (textual languages).

■ Assisted data entry functions via:

- Access to DFB function libraries, to the variable selector, and to the text object for entering comments
- Initialization of a variable reference
- Initialization of the animation table on selected variables
- Display and modification of the properties of the selected variable
- Creation of variables in real time without having to use the data editor

■ “Cut”, “Copy”, “Paste”, “Delete”, “Move”, etc.

■ The use of bookmarks on lines of text or in the margin so that you can:

- Easily locate lines in important program sections
- Browse in an editor by bookmark, label, or line and column number

Ladder (LD) language

Each section or subroutine using Ladder language consists of a series of rungs that are executed sequentially by the PLC. Each rung consists of graphic objects (placed in cells arranged in columns and lines) corresponding to contacts, links, coils, operation blocks, EF/EFB/DFB function blocks, jumps, sub-routine calls, etc.

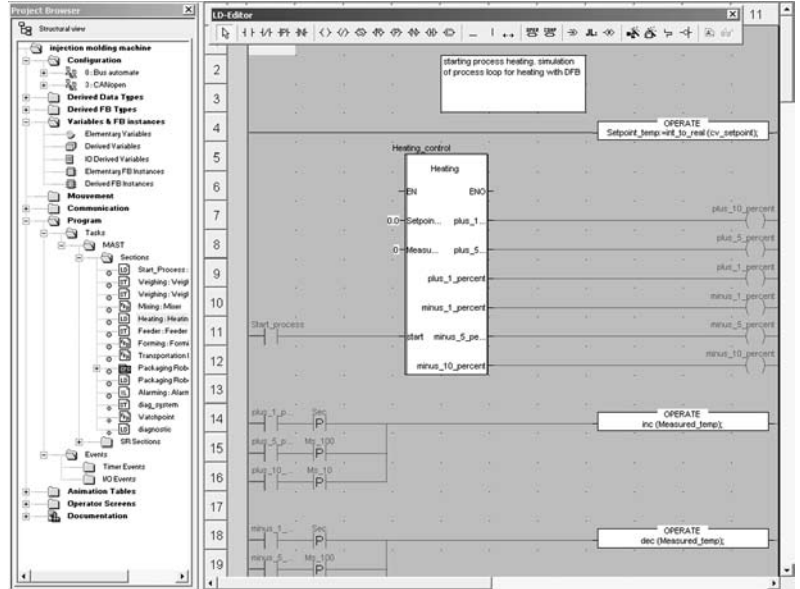

Program structure (section or subroutine)

Each Ladder language section can contain:

- Between 11 and 64 columns (number set by user)
- Up to 2,000 lines (for rungs in the section)



Graphics palette in the Ladder language editor

“Mixed Display” mode supports the unrestricted display of comments, addresses, and symbols for the variables used for rungs.

Function Block Diagram (FBD) language

Function Block Diagram language is a graphical language based on function blocks associated with variables or parameters that are linked together. This language is particularly well suited for process control applications.

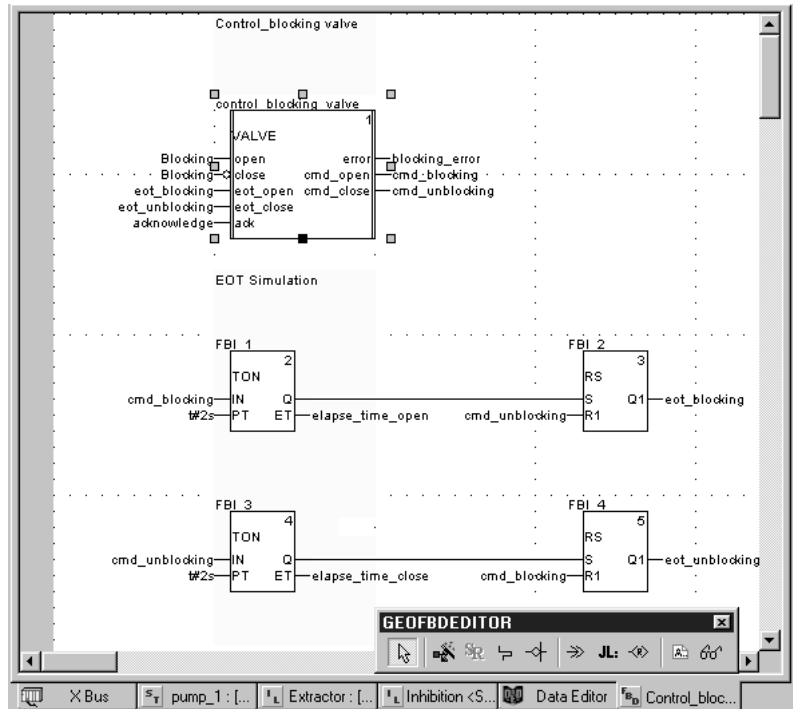

4



Function Block Assistant

Program structure (section or subroutine)

The FBD graphical language consists of three types of function block:

- Elementary blocks (EFs)
- Elementary Function Blocks (EFBs) that are sorted into different libraries depending on their type of use
- Derived Function Blocks (DFBs) have a structure identical to that of EFBs but are created by the user with the ST, IL, LD, or FBD programming languages

Within the same section, subroutines can be called using a specific block. Program jumps to a block instance can also be programmed.

A section programmed in FBD language contains the equivalent of a grid with 30 columns and 23 rows. This can be extended to a wider page.

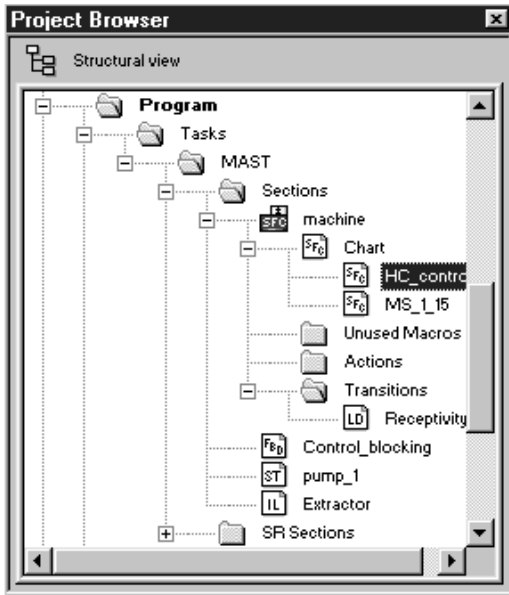

SFC structure in the browser

Sequential Function Chart (SFC) and Grafcet™ language

Sequential Function Chart (and Grafcet) language can be used to describe the sequential part of an automation system in simple graphical format using steps and transitions.

SFC language does not process charts in the same way as Grafcet language:

- SFC only authorizes one token in a single chart.
 - Grafcet language authorizes several tokens in a single chart.
- Unity™ Pro software has one single editor for both of these languages with the option of defining Behavior in the application settings (Tools/Project Settings/Language extensions menu).

Program structure (master task section)

SFC language is only used in sections belonging to the master task. Each SFC section consists of a main chart sub-section (CHART) and sub-sections for each of the macro-steps. Charts consist of:

- Macro-steps are the unique reintroduction of a set of steps and transitions (used to setup a hierarchical chart structure)
 - Steps
 - Transitions and directed links between steps and transitions
- Associated with steps and transitions, respectively, the actions and transition conditions can be:
- Integrated into the CHART or macro-step charts and the actions or transition conditions are defined by a single variable
 - Processed in specific sections that require dedicated processing (programmed in Ladder, Function Block Diagram, Structured Text or Instruction list language).
- To check that machine scans have been completed successfully, activity times (minimum, maximum) can be associated with each step. These times are set by the user.

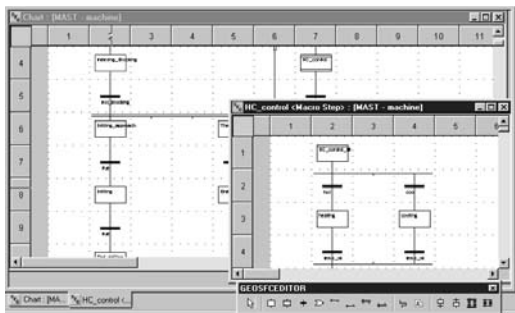

SFC charts

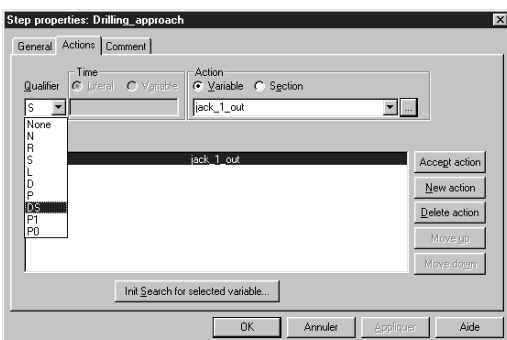

Step properties

Program structure (section in master task)

For each SFC section, the graphics editor provides a maximum of:

- One grid containing 32 columns and 200 rows, or 6,400 cells. Steps, transitions, or jumps need one cell, respectively.
- 1,024 steps (macro-steps and steps in macro-steps)
- 20 actions assigned to the same step
- 100 steps activated at the same time
- 100 actions activated at the same time

To help you to create basic charts, graphic screens can be used to create “n” steps in series and “m” steps in parallel in a single operation.

Dialog boxes can be used to assign associated properties to steps (activity time, actions), transitions (variable linked to transition condition), etc.

Structured Text (ST) language

Structured Text language is a sophisticated algorithmic type language that is particularly well suited for programming complex arithmetic functions, table operations, message handling, etc.

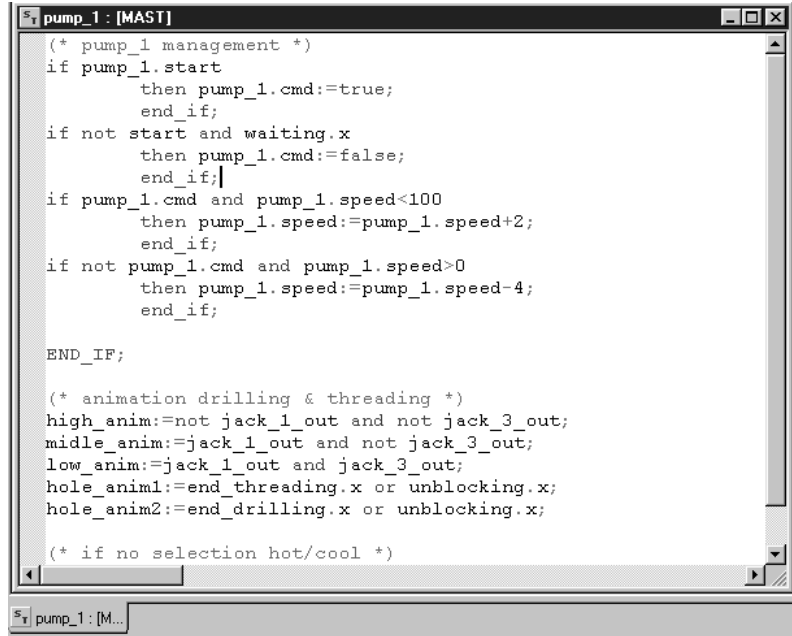

```

pump_1 : [MAST]
(* pump_1 management *)
if pump_1.start
  then pump_1.cmd:=true;
  end_if;
if not start and waiting.x
  then pump_1.cmd:=false;
  end_if;
if pump_1.cmd and pump_1.speed<100
  then pump_1.speed:=pump_1.speed+2;
  end_if;
if not pump_1.cmd and pump_1.speed>0
  then pump_1.speed:=pump_1.speed-4;
  end_if;

END_IF;

(* animation drilling & threading *)
high_anim:=not jack_1_out and not jack_3_out;
middle_anim:=jack_1_out and not jack_3_out;
low_anim:=jack_1_out and jack_3_out;
hole_anim1:=end_threading.x or unblocking.x;
hole_anim2:=end_drilling.x or unblocking.x;

(* if no selection hot/cool *)

```

Program structure (section or subroutine)

Structured Text language can be used to directly transcribe an analysis based on an organization chart and is structured into expressions composed of a series of instructions organized in lines.

There is no limit to the number of characters an instruction line may contain (the only limit is the program memory available for the Modicon® M340™, Premium™, and Quantum™ platforms, except on TSX P57 10 to 40 processors, where the limit is 64 kbytes). The length of the section is only limited by the size of the application memory.

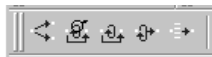

Four preformatted expression structures can be called up directly from the toolbar:

- **Conditional action:** *IF...THEN...ELSIF...THEN...ELSE...END-IF*
- **Iterative conditional action:** *WHILE...DO...END_WHILE;*
REPEAT...UNTIL...END_REPEAT
- **Repetitive action:** *FOR...TO...BY...DO...END_FOR*
- **Selective action:** *CASE...OF...ELSE...END_CASE*

The operands used in the expressions are bit variables, word variables, or variables linked to function blocks.

To make the expressions easier to read, different colors are used to identify objects, language key words, and program comments.

Instruction List (IL) language

Instruction List language represents the equivalent of a Ladder diagram in text form. It can be used to write Boolean and arithmetic equations using the functions available in the Unity™ Pro language (calling of functions and function blocks, assignment of variables, creation of program jumps, branching to subroutines within a program section, etc.).

```

(* Simple example *)
LD t#5s
ST delay

(* fault motor *)
LD overspeed
AND hot_temp
ST fault_motor

(* Start the motor after delay (in seconds) *)
CAL MOTOR_TIMER (PT := Delay, IN := start_motor)
LD motor_timer.q
ST motor_run

(* Stop the motor after ten seconds in running *)
cal stop_timer(motor_run,t#10s)
LDN stop_timer.q
ST start_motor

```

The screenshot shows a window titled 'pump_1 : [...]' with a toolbar containing icons for 'Extractor : [...]', 'Inhibition <S...', 'Data Editor', and 'Bus'. The main area displays the IL code with a cursor on the 'cal stop_timer' line.

Program structure (section or subroutine)

A program in Instruction List language comprises a sequence of instructions classified into the following different families:

- Bit instructions, for example, read input: *LD overspeed*
- Function block instructions, for example, call timer: *CALL MOTOR_TIMER*
- Numerical instructions using single, double, and floating-point integers, for example, add: *LD Result ADD Surplus ST Archive*
- Word table or character string instructions, for example, make assignment: *LD Result:10:=Setpoint:10*
- Program instructions, for example, SR call: *CALL SR10*

The operands used in the expressions are bit variables, word variables, or variables linked to function blocks.

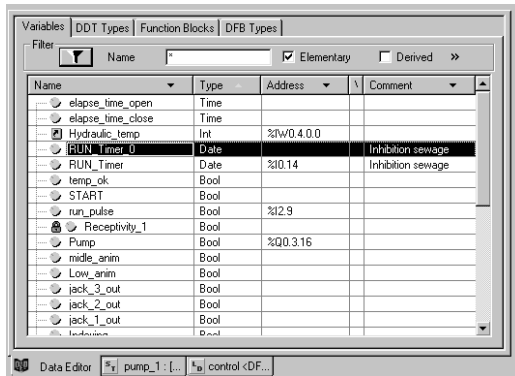

Data editor

Data editor

The data editor can be accessed from the structural view of the project and provides a single tool for performing the following editing tasks:

- Declaration of data including variables and function blocks (declaration of their type, instances, and attributes)
- Use and archiving of function block data types in different libraries
- Hierarchical view of data structures
- Searching, sorting, and filtering of data
- Creation of a hyperlink in the comments of any variable to access a description

The data are displayed on four tabs:

- “Variables” tab for the creation and management of the following data instances: bits, words, double words, inputs/outputs, tables, and structures
- “DDT Types” tab for the creation of derived data types (tables and structures)
- “Function Blocks” tabs for the declaration of EFB and DFB function blocks
- “DFB Types” for the creation of DFB user function block data types

Each data element has several attributes including the following guidelines:

- The name and type of the variable are mandatory
- The comment, physical address in the memory, and initial values are optional

The data editor columns can be configured (number of columns, order). The attributes associated with a variable can be displayed in a properties window.

This editor can be accessed at any time during programming by selecting variables for data modification or creation.

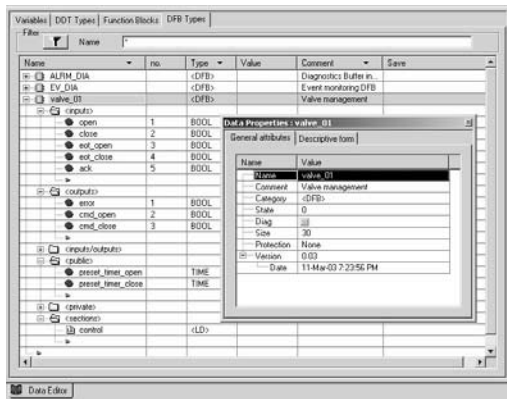

Variable attributes

4

DFB user function blocks

With Unity™ Pro software, users can create their own function blocks for specific application requirements on Modicon® M340™, Atrium™, Premium™, and Quantum™ platforms.

Once created and saved in the library, these user function blocks can be reused as easily as EFBs (Elementary Function Blocks).

The user function blocks can be used to structure an application. They are used when a program sequence is repeated several times in the application or for mounting a standard programming routine. They can be read-only protected or read/write-protected. They can be exported to all other Unity Pro applications.

Using a DFB function block in one or more applications:

- Simplifies program design and entry
- Improves program readability and understanding
- Facilitates program debugging (variables handled by the DFB block function are identified in the data editor)
- Enables the use of private variables specific to the DFBs that are independent of the application.

A DFB function block is setup in several phases:

- The DFB is designed by assigning a name, a set of parameters (inputs, outputs, public and private internal variables) and a comment to it via the data editor.
- The code is created in one or more sections of the program, with the following languages selected according to requirements: Structured Text, Instruction List, Ladder, or Function Block Diagram (ST, IL, LD, or FBD).
- The DFB may be stored in a library with an associated version number.
- A DFB instance is created in the data editor or when the function is called in the program editor.
- This instance is used in the program in the same way as an EFB (Elementary Function Block). The instance can be created from within the program.

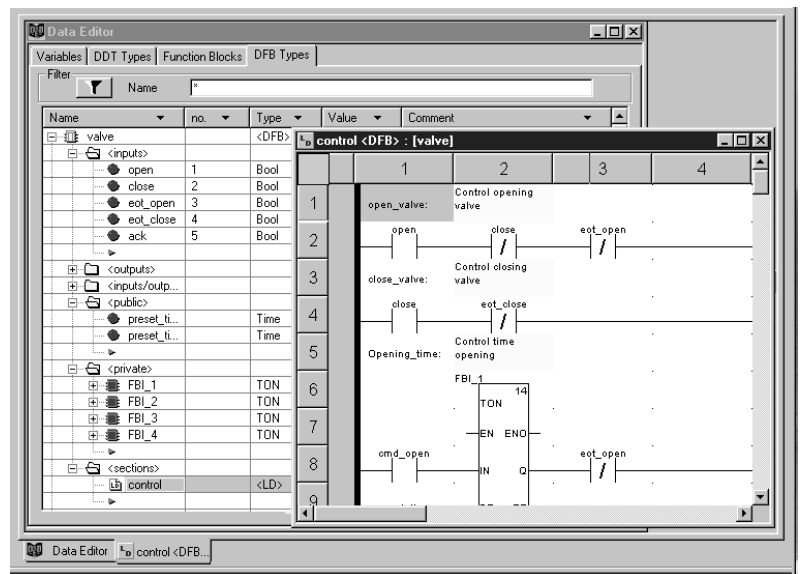

Main specifications

Inputs	32, maximum (1)
Outputs	32, maximum (2)
Inputs/outputs	32, maximum (1) (2)
Public internal variables	Unlimited (3), can be accessed via the application program
Private internal variables	Unlimited (3), cannot be accessed via the application program
Comments	1,024 characters, maximum
Program sections	Unlimited, each section can be programmed independently in one of the 4 languages (IL, ST, LD, and FBD).

(1) The maximum cumulative total of inputs and inputs/outputs is 32.

(2) The maximum cumulative total of outputs and inputs/outputs is 32.

(3) For Premium processors, see page 43400-EN/5: specifications, memory capacity, maximum size of object areas, unlocated internal data, and DFB and EFB function blocks.

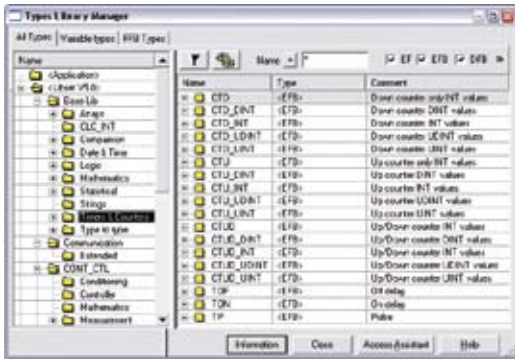

Standard function block libraries

Function block libraries

The function and function block libraries manager contains the elements provided with Unity Pro software. The functions and function blocks are organized into libraries. Each library consists of families of functions and function blocks. Depending on the type of PLC selected and the processor model, users will have a sub-set of these libraries available to write their applications. However, the “Base Lib” library contains a set of functions and function blocks that are compatible with all platforms. In particular, it contains the blocks compliant with IEC 61131-3.

The “Base Lib” library is structured into families:

- Timers and counters
- Process control on integers
- Array management
- Comparison
- Date and time management
- Logic processing
- Mathematical processing
- Statistical processing
- Character string processing
- Type-to-type data conversion

The “Base Lib” library covers standard automation functions and is supplemented by other, more application-specific libraries and platform-specific functions:

- **Communication library**, providing an easy means of integrating communication programs from PLCs with those used by HMIs from the PLC application program. Like other function blocks, these EFBs can be used in all languages to exchange data among PLCs or to deliver data to be displayed on an HMI.
- **Process control library**. The CONT_CTL library can be used to setup process-specific control loops. It offers controller, derivative, and integral control functions, and additional algorithms such as: EFBs for calculating mean values, selecting a maximum value, detecting edges, or assigning a hysteresis to process values, etc.
- **Diagnostics library** can be used to monitor actuators and contains EFBs for active diagnostics, reactive diagnostics, interlocking diagnostics, permanent process condition diagnostics, dynamic diagnostics, monitoring of signal groups, etc.
- **I/O management library**, providing services to handle information exchanged with hardware modules (formatting data, scaling, etc.)
- **Motion Function Blocks library**, containing a set of predefined functions and structures to manage motion controlled by drives and servo drives connected on CANopen
- **Motion library** for motion control and fast counting
- **“System” library** provides EFBs for the execution of system functions, including: evaluation of scan time, availability of several different system clocks, SFC section monitoring, display of system state, management of files on the memory cartridge of the Modicon® M340™ processor, etc.
- Finally, a library named “obsolete” containing function blocks used by legacy programming software needed to perform application conversions

Management of user standards

Users may create libraries and families to store their own DFB function blocks and DDT data structures. This enhancement allows users to take advantage of programming standards adapted to their needs, along with version management. This means that it is possible to:

- Check the version of the elements used in an application program against those stored in the library
- Perform an upgrade, if necessary

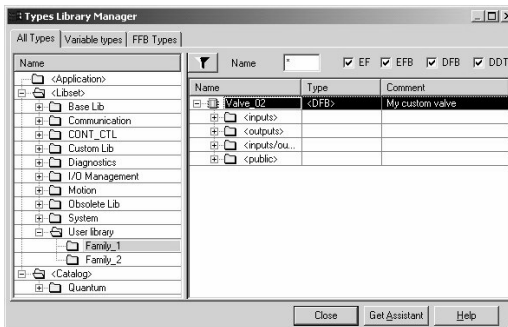

User-defined libraries



Insertion/deletion of watchpoint

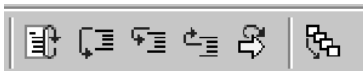

Execution: step-by-step command

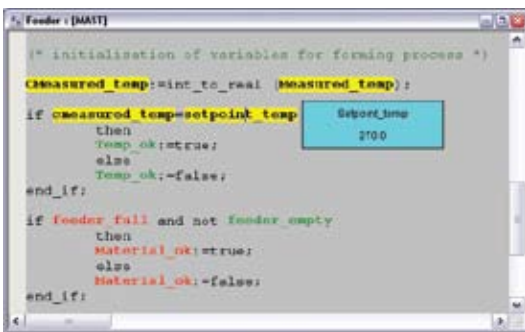

Animation of ST program

Name	Value	Set Value	Type	Comment
Flag	0		TP	Flag to stop
PI	0		BOOL	Flagge pulse
PII	0		BOOL	Feed pulse duration
PIII	0		BOOL	Pulse output
PIIIII	0		TIME	Interval time
Weighting_material_A	0	1	INT	Weighting material A in progress
valve_A_closed	0		BOOL	Material valve A closed
weight_empty	0		BOOL	Weight empty
max_material_dismount	0		BOOL	Max material for feeder dismount
Start_process	0	1	BOOL	Internal variable for process start
Flagge_open	0		BOOL	Flagge open
Flagge_A	0		BOOL	Internal variable (Flagge Material B)
Flagge_s	0		BOOL	Internal variable (Flagge Material A)
max_ready	0	1	BOOL	Max ready

Animation table

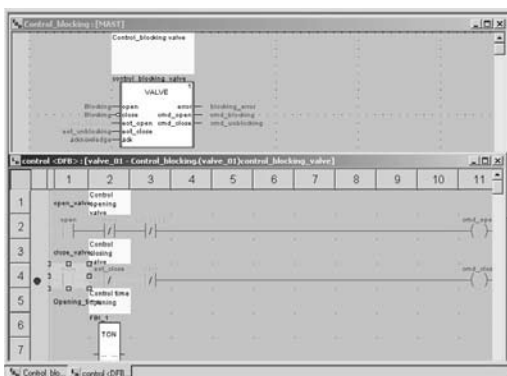

Debugging tools

Unity™ Pro software offers a complete set of tools for debugging Modicon® M340™, Atrium™, Premium™, and Quantum™ applications. A tool palette provides direct access to the main functions:

- Dynamic program animation
- Setting of watchpoints or breakpoints (not authorized in event-triggered tasks)
- Step-by-step program execution. A function in this mode enables section-by-section execution. Instruction-by-instruction execution can be launched from the previous breakpoint. Three execution commands are therefore possible when the element to be executed is a subroutine (SR) or DFB user block instance:
 - Detailed step-by-step, or “Step Into”. This command is used to move to the first element of the SR or DFB.
 - Overall step-by-step, or “Step Over”. This command is used to execute the entire SR or DFB.
 - Outgoing step-by-step, or “Step Out”. This command is used to move to the next instruction after the SR or DFB element.
- Independent execution of the master (MAST), fast (FAST), auxiliary (AUX) and event-triggered (EVTi) tasks

Animation of program elements

Dynamic animation is managed by program section. A button on the toolbar is used to activate or deactivate animation for each section.

When the PLC is in RUN, this mode can be used to view, simultaneously:

- The animation of a program section, regardless of the language used
- The variables window containing the application objects created automatically from the section viewed
- Several windows can be displayed and animated simultaneously. The “Tool tip” function uses help balloons and can be used to view a variable or its content simultaneously when the object is selected with the mouse (or other pointing device). Users can add inspection windows to display program variables.

Two types of animation are supported:

- Standard: The variables of the active section are refreshed at the end of the master task (MAST).
- Synchronized: The watchpoint can be used to synchronize the display of animated variables with a program element to determine their value at that precise point in the program.

Animation table

Tables containing the variables of the application to be monitored or modified can be created by data entry or initialized automatically from the selected program section.

In addition to data animation it is possible to:

- Modify bit variables or force them to 0 or 1
- Change the display format
- Copy or move variables
- Search by cross-reference
- Display the list of forced bits

These tables can be stored in the application and retrieved from there at a later time.

Debugging of DFB user function blocks

The parameters and public variables of these blocks are displayed and animated in real time using animation tables with the option of modifying and forcing the required objects.

In exactly the same way as with other program elements, the watchpoint, breakpoint, step-by-step execution, and program code diagnostics functions can be used to analyze the behavior of DFBs. Setting a breakpoint in a DFB user function block instance stops the execution of the task containing this block.



SFC control panel

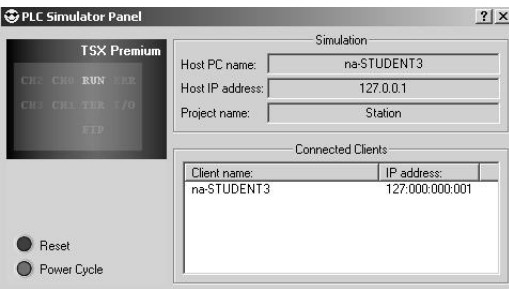

Simulator control panel

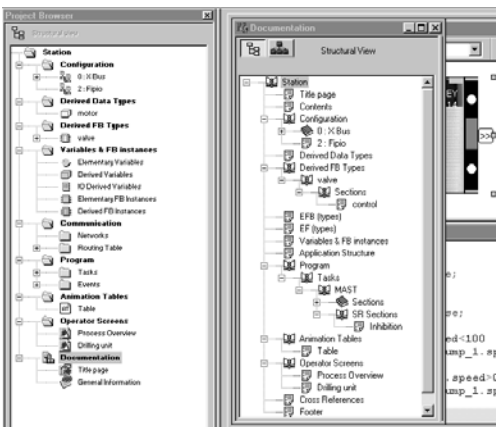

Access to documentation editor

Debugging tools (continued)

Debugging in Sequential Function Chart (SFC) language

The various debugging tools are also available in SFC language. However, unlike other sections (IL, ST, LD, or FBD) an SFC section executed step-by-step does not stop execution of the task but instead freezes the SFC chart. Several breakpoints can be declared simultaneously within a single SFC section.

Numerous commands are available in this debugging mode via the control panel:

- Deactivate active step(s)
- Activate initial step(s)
- Disable step execution times
- Freeze chart regardless of transition conditions
- Stop processing of steps
- Move to the next step taking account of the transition conditions
- Enable transition and move to next step(s) (detailed step-by-step command: "Step Into")
- Enable transition to execute the end of the macro-step (outgoing step-by-step command: "Step Out")
- Pre-position chart on steps where markers have been set, etc.

PLC simulator

The simulator integrated into Unity™ Pro can be used to test the application program for Modicon® M340™, Atrium™, Premium™, or Quantum™ PLCs from the PC terminal without having to connect to the PLC processor. The functions provided by the debugging tools are available for debugging the master, fast, and auxiliary tasks. Because the simulator does not manage the PLC I/O, animation tables can be used to simulate the state of inputs by forcing them to 0 or 1.

The simulator can be connected to third-party applications via an OPC server with OFS (OPC Factory Server) software.

Documentation editor

The documentation editor is based on the Documentation Browser that shows the file structure in tree form.

It allows all or part of the application file to be printed on any graphics printer accessible under Windows® and using True Type technology, in A4 or US letter print format.

The documentation editor supports the creation of user-specific files using the following headings:

- Title page
- Contents
- General information
- Footer
- Configuration
- EF, EFB, and DFB type function blocks
- User variables
- Communication
- Project structure
- Program
- Animation tables and cross references
- Runtime screens

The documentation editor can generate the documentation file based on two different structures:

- Structural view: The objects in the project are associated with their corresponding headings.
- Functional view: The objects in the project are associated with the function modules to which they belong.

The documentation file can be created and saved as the project progresses, from one Unity Pro session to another.

Introduction

Diagnostics integrated into Modicon® M340™, Atrium™, Premium™, and Quantum™ automation platforms

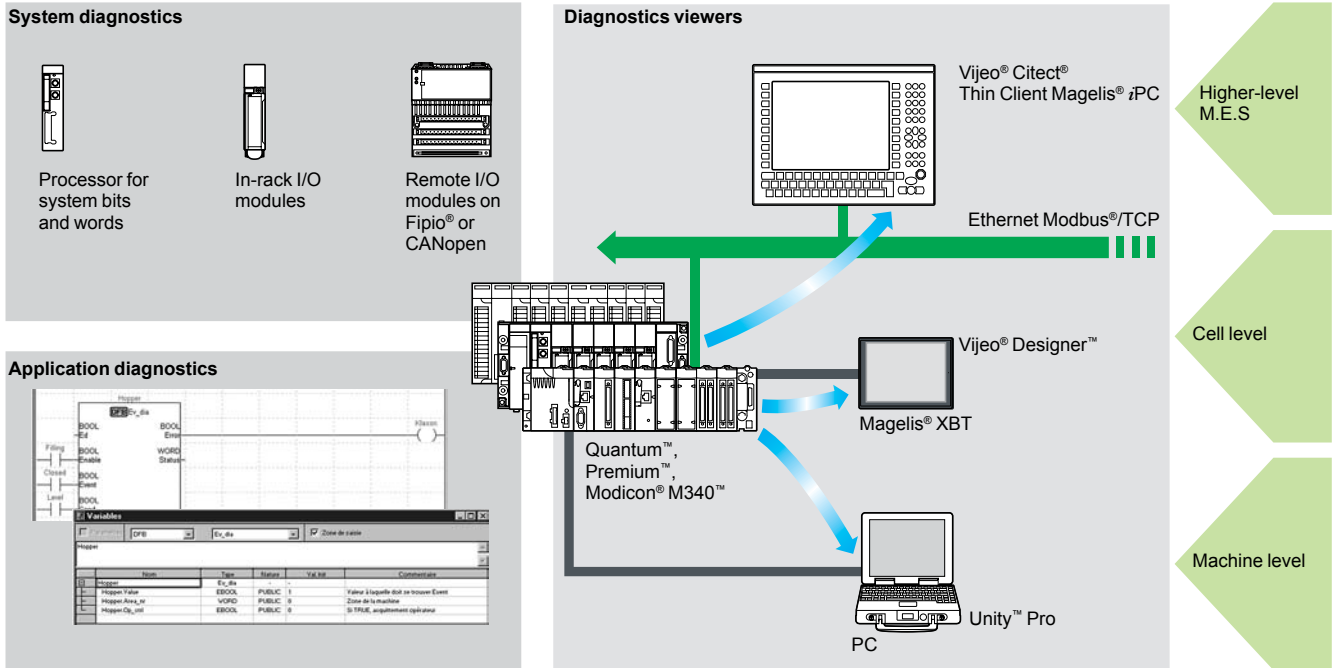

The diagnostics offer for Modicon® M340™, Atrium™, Premium™, and Quantum™ is based on three components:

- System diagnostics
- DFB and EFB diagnostic function blocks (for system and application diagnostics)
- Error message display systems, called viewers, supplied as a standard component of Magelis® XBT terminals, Vijeo® Citect® supervisory software, and Unity™ Pro setup software

Functions

System diagnostics

The system diagnostics for the Modicon M340, Atrium, Premium, and Quantum platforms support the monitoring of system bits/words, I/O modules, and activity times (minimum/maximum) of SFC steps. By simply choosing the relevant option during application configuration, any event will generate time-stamped messages logged in the diagnostic buffer of the PLC. These events are displayed automatically on a diagnostics viewer (1) without requiring any additional programming.

With Unity Pro integrated diagnostics, this function can be used to perform 1st level diagnostics of the elements in the configuration, up to and including each I/O module channel.

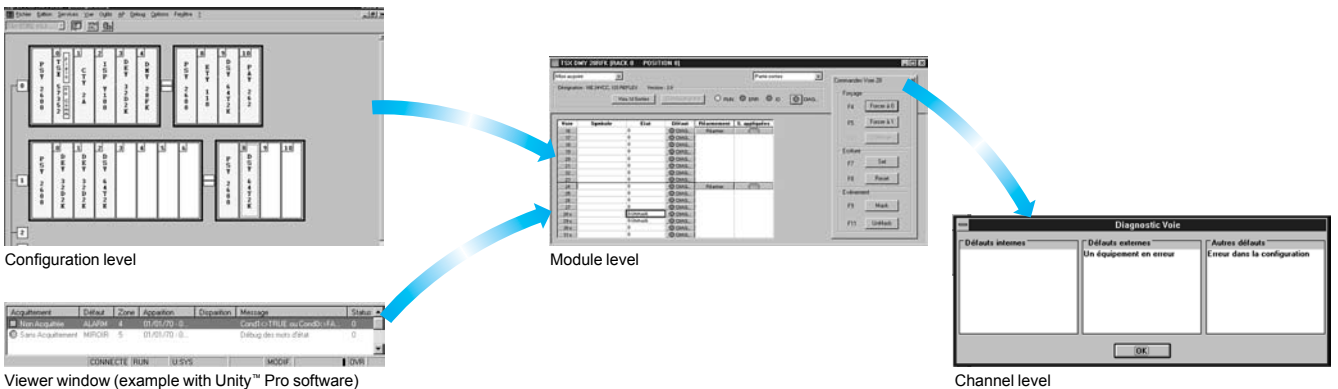

(1) Diagnostics viewers are tools used to display and acknowledge diagnostic error messages. They are supplied as a standard component of Unity™ Pro and Vijeo Designer™ software with Magelis® terminals, and with the PLC web server that can be accessed via a Magelis iPC™ thin client.

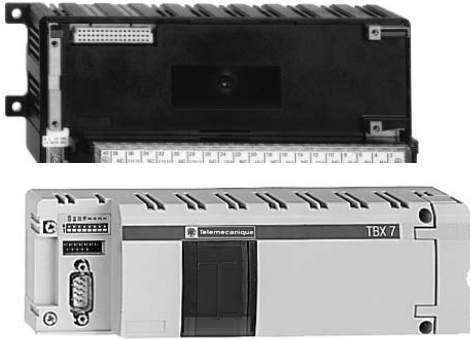

Functions (continued)

Application diagnostics

Unity™ Pro software features a library of function blocks for monitoring called diagnostic DFBs and EFBs. The library of diagnostic function blocks comprises:

■ Manufacturer blocks for system diagnostics

- IO_DIA input/output detected fault that is used to monitor the I/O states
- ASI_DIA monitors whether a communication error has occurred on the AS-i bus (module or bus detected fault, no slave, slave not configured or inoperative)

■ Manufacturer blocks for application diagnostics

- EV_DIA monitors that an event (bit status) assumes the correct value at a specific time (no notion of timing)
- MV_DIA, D_GRP, D_REA monitor whether an event (change of bit status) occurs according to predefined time conditions
- ALRM_DIA monitors the combination of the status of 2 bits
- NEPO_DIA and TEPO_DIA are used to check, control, and perform diagnostics on elements of the operative part consisting of a combination of 2 preactuators and 2 sensors

■ Open diagnostic blocks

These blocks allow users to create their own diagnostic function blocks customized to their specific applications, and supplementing the manufacturer DFBs and EFBs presented above. Open diagnostic blocks are created from 2 model blocks that must be written either in Ladder (LD) language, or in Structured Text (ST), Function Block Diagram (FBD), or Instruction List (IL).

4

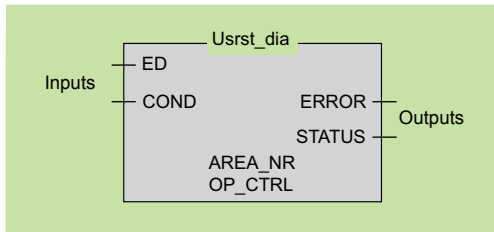

Diagnostics with detected fault cause analysis

When a detected fault occurs, Unity Pro analyzes the relevant program sections and displays the probable causes and sources of the detected fault in a second window.

The user or process operator is guided through the detected fault analysis process and will be able to reduce machine downtime as a result.

With the diagnostics viewer integrated into Unity Pro, the instruction or module that caused the detected fault can be accessed directly from the alarm displayed in the viewer display window. See page 4/25.

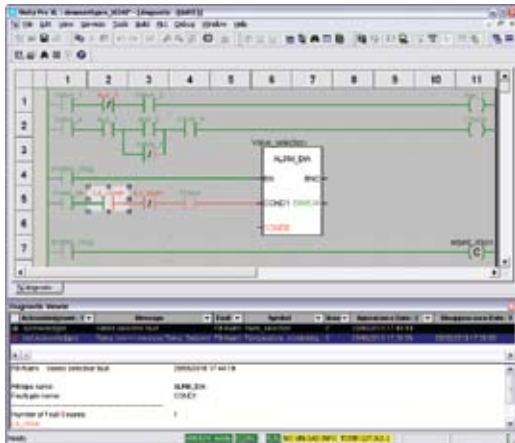

Diagnostics with detected fault cause analysis



Viewer

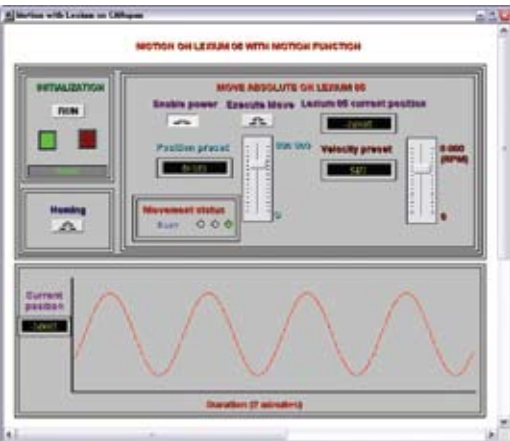

Functions (continued)

Diagnostics viewers

The diagnostic events processed by the Modicon® M340™, Atrium™, Premium™, and Quantum™ platforms via diagnostic DFBs/EFBs are stored in a buffer (specific data memory area of the PLC). The information contained in this buffer is sent (transparently for the user) to viewers for automatic display and for management of detected faults and alarms. The view function is supplied as a standard component for:

- Vijeo® Designer™ configuration software
- Unity™ Pro programming software
- Magelis® XBT GT and Magelis iPC™ graphic display terminals

The viewer integrated into Unity Pro can also be used to access the instruction or module that is the source of the detected fault. See "Diagnostics with detected fault case analysis" on page 4/60.

The Modicon M340, Atrium, Premium, and Quantum platforms have multiviewer capability (and can be connected to up to 15 viewers). A PC-compatible station with the viewer function can have multi-PLC capability (and can be connected to up to 15 Modicon M340/Atrium/Premium/Quantum platforms).

The buffer/viewer structure supports:

- A single point for detected fault management in each application
- Time-stamping of the occurrence of detected faults at the source
- Storage of intermittent detected faults in memory
- Independence with regard to the viewer functionality. The frame sent from the PLC buffer is identical for all viewers.
- Automatic archiving of detected error messages

Display window

The diagnostics viewer takes the form of a display window divided into 2 sections:

- A message list area containing, for each alarm: state, DFB type, geographical zone, dates and times of appearance/disappearance, associated message, and status
- An area for additional information about the selected message: type, comments, date of appearance, specific data, variables in incorrect state, etc.

Runtime screens

The runtime screens tool is integrated into Unity Pro software. Runtime screens are designed to facilitate running automated processes during debugging, startup, and maintenance. Runtime screens provide a range of information (explanatory texts, display of dynamic values, control buttons, and views), enabling users to act quickly and easily to modify and dynamically monitor PLC variables.

The runtime screens editor provides the HMI (*Human/Machine Interface*) elements needed for the animated design and viewing of processes. It enables these screens to be designed using specific tools:

- Screen: creation of runtime screens that can be classified according to family
- Message: creation of messages to be displayed
- Objects: creation of a graphic objects libraries based on:
 - Geometrical elements (line, rectangle, ellipse, incorporation of images, controller front panels, etc.)
 - Control elements (buttons, data entry fields, screen browsing controls, etc.)
 - Animation elements (colors, flashing elements, bar graphs, etc)

When the installed Unity Pro station is connected to the PLC, users can obtain a dynamic screen display based on the process state. Depending on the assigned priority, screens can be sequenced via a keyboard command or a PLC request. In online mode, the Unity Pro application program can be directly accessed via the runtime screens simply by clicking the selected object in a screen view. It is also possible to activate the animation-table or cross-reference functions after selecting one or more variables on the screen. To make the display easier to read, the views can be displayed in full screen mode. Because it is possible to create or modify a runtime screen when the PLC is in Run mode, this service increases productivity during installation and maintenance phases.

Modifying the program with the PLC in RUN mode

With Unity™ Pro, changes can be made to the program when the PLC connected to the programming terminal is in RUN mode. These modifications are performed with the following operations:

- The application contained in the PLC is transferred to the PC terminal running Unity Pro (if necessary).
- Make program changes. These program modifications can be of any type and in any language (IL, ST, LD, FBD, and SFC), for example, addition or deletion of SFC steps or actions. The code of a DFB user function block can also be modified. (However, modifications of its interface are not permitted.)
- These program changes are updated in the PLC (in RUN mode).

This function makes it possible to add or modify program code and data in different parts of the application in a single modification session which results in a unified, consistent modification. This increased flexibility requires additional program memory.

Cross-reference function

The Unity Pro cross reference function is available in standalone mode (offline) and when connected to the PLC in Run (online). It allows users to view all the elements of a PLC application when searching for any type of variable. This view indicates where the declared variable is used, as well as how it is used (writing, reading, etc.).

This function also provides access to the Search/Replace function used for variable names.

The variable search can be initialized from any editor (language, data, runtime screen, animation table, etc.).

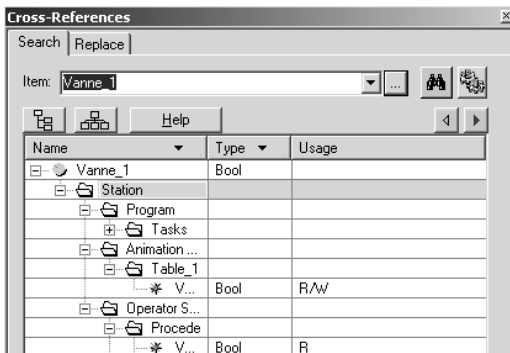

Import/export function

The import/export function available in Unity Pro supports the following operations from the structural and functional project views:

- The import function allows you to reuse any portion of a project previously created in the current project
- The export function allows you to copy any portion of the current project to a file for subsequent reuse

The files generated during export are generally in XML format (1). However, in addition to XML, variables can be exported and imported in the following formats:

- .xvm format compatible with OFS data server software
- Source format, in an .scy file compatible with the PL7 programming software
- Text format with separator (TAB) in a .txt file for compatibility with other systems

During an import, a wizard is used to reassign data to new instances of:

- DFB function blocks
- DDT data structures
- Simple data

In addition, when a functional module is imported, the data associated with animation tables and runtime screens are also reassigned.

The XML import function also supports the transfer of a Modicon® M340™, Atrium™, Premium™, or Quantum™ PLC configuration prepared in the SIS Pro costing and configuration tool for use in Unity Pro projects.

This import function eliminates the need for the user to redefine the PLC configuration when the PLC has already been configured with the SIS Pro tool.

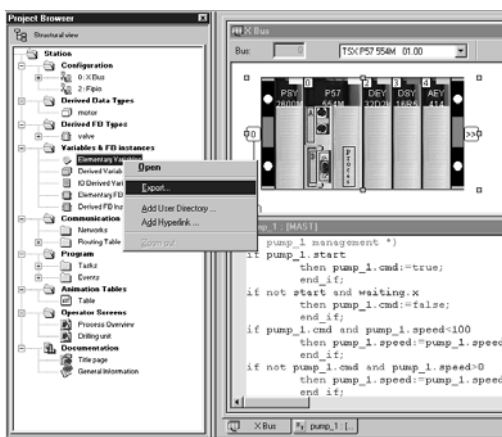

(1) XML language is an open, text-based language that provides structural and semantic information.

Application converters

Unity™ Pro integrated conversion tools can be used to convert PLC applications created with Concept™ and PL7™ programming software into Unity Pro applications.

Concept™/Unity™ Pro converter (Quantum™ PLC)

This conversion is performed with a Concept application V2.5 or later (V2.11 or later, with an update to V2.5). To perform the conversion, the application must be exported to an ASCII file in Concept.

The export file is converted to a Unity Pro source file automatically. This source file is then analyzed by Unity Pro. At the end of the procedure, a conversion report is generated, and an output window displays any conversion errors and provides direct access to the part of the program to be modified. The Concept application converter converts the application to Unity Pro. It is recommended that the application is tested or debugged to verify that it operates correctly.

PL7™/Unity™ Pro converter (Premium™ PLC and Atrium™ slot PLC)

This conversion is performed with a PL7 application V4 or later (Premium PLC or Atrium slot PLC). To perform the conversion, the complete application or user function block source files must be exported in PL7.

The conversion procedure is similar to the Concept conversion described above.

Note: Applications created with Concept™, Modsoft®, and ProWorx™ software can be converted to LL984. Please consult your Regional Sales Office for more information.

Operating system update utilities

The OS-Loader software designed for updating operating systems on Atrium™, Premium™, and Quantum™ platforms is supplied with Unity™ Pro software. It is used to upgrade processors and modules in PL7™ or Concept™ for compatibility with Unity Pro:

- Premium **TSX P57 2●3M/2623M** and **TSX P57 3●3M/3623M** processors
- Quantum **140 CPU 434 12A** and **140 CPU 534 14A** processors (requires version PV 04 or later)
- Ethernet **TSX ETY ●102** and **140 NOE 771 ●1** communication modules
- EtherNet/IP **TSX ETC 100** and **140 NOC 77100** communication modules

The following operating system updates are performed for the various processor types:

- Uni-Telway™ RS 485 terminal link for Premium processors
- Modbus® or Modbus Plus™ terminal link for Quantum processors
- Ethernet Modbus/TCP network for integrated Ethernet port on Premium processors and Ethernet Premium and Quantum modules(1)

Note: For Modicon® M340™, this service is provided by Unity™ Loader.

(1) The operating system of the Quantum 140 CPU 671 60 processor is updated over an Ethernet network using its MT-RJ type fiber-optic connector (via a ConneXium™ transceiver or switch for a copper wire/fiber-optic interface).

Unity™ Pro XLS

In addition to the functions of Unity™ Pro Extra Large, Unity™ Pro XLS provides a set of function blocks of specific checks and protections to facilitate the creation and debugging of SIL3 Quantum™ PLC projects.
For a description of these specifications, setups, and the functional limitations provided for within the framework of SIL3-certifiable safety projects according to IEC 61508, refer to the “*Quantum Safety PLC, Safety Reference Manual*” 11/2007, n° 3303879.00, approved by TÜV Rheinland and available at www.schneider-electric.us/.

The Unity Pro XLS programming tool is certified compliant with the requirements of IEC 61508 for the management of safety applications with Quantum **140 CPU 651 60S/671 60S** PLCs.

It offers the complete range of functions required to program a safety project:

- In-depth error diagnostics
- Project protection

During project creation, the Quantum processor selects and determines whether the project created will be a safety project.

Unity Pro XLS is capable of processing all Unity Pro application types. No other programming tool is needed on the computer.

To program a safety project, Unity Pro XLS provides two IEC 61131-3 programming languages:

- Function Block Diagram (FBD)
- Ladder language (LD)

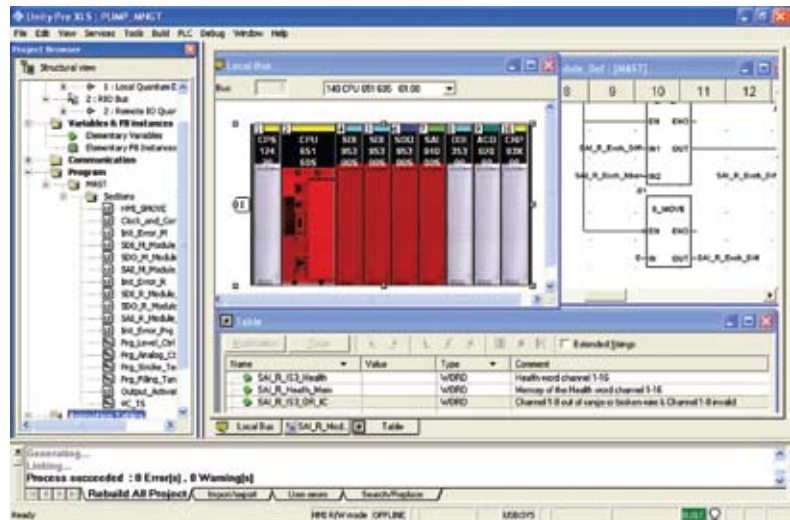

Unity™ Pro XLS (continued)

Safety program structure

A safety project must be programmed entirely in a master task (MAST).

It is not possible to:

- Program FAST, TIMER, INTERRUPT, or AUX tasks
- Use subroutines (SR sections)

Language elements

Unity™ Pro XLS provides a set of specific, certified functions and function blocks. These are available in the “Unity Pro safety function block library”.

Most of the language elements are available:

- Elementary data types (EDTs): BOOL, EBOOL, BYTE, WORD, DWORD, INT, UINT, DINT, UDINT, and TIME
- Simple arrays used exclusively for Ethernet Global Data communication
- Direct addressing, for example, writing%MW to memory via a coil in Ladder Logic (LD)
- Located variables

Project checking options

Unity Pro XLS provides the following different options for the checks performed by the language analyzer:

- Unused variables
- Variables written multiple times
- Unassigned parameters
- FB instances used multiple times
- Address overlapping

It is advisable to enable all options when checking a safety project.

Unity™ Pro XLS (continued)

Protecting the project

Unity™ Pro XLS provides protective functions against unauthorized access to safety projects, to the SIL3 Quantum™ PLC, and to Unity Pro XLS.

- The application password, defined when the safety project was created is requested:
 - When the safety application file is opened
 - Upon connection to the SIL3 Quantum PLC



- The safety editor integrated into Unity Pro XLS is used to define the access permissions and the list of authorized functions for each user, in particular:
 - Creation and modification of the application password
 - Activation of maintenance mode
 - Adjustment of the auto-lock period

Functions and function blocks for safety applications

Unity Pro XLS provides a set of elementary functions (EFs) and elementary function blocks (EFBs) certified for use in safety applications:

- Standard functions certified for safety applications:
 - Mathematical functions and functions for manipulating data from the unrestricted memory area in the safety logic
 - Comparison functions
 - Logical functions, rotations, offsets
 - Statistical functions
 - Timer and counter setup
 - Type conversions
- Specific functions for safety architectures:
 - Setup of high availability: Choose between two discrete I/O module inputs or redundant analog inputs
 - Setup of hot standby PLC redundancy: To cause the two processors involved in a hot standby configuration to change roles from primary to standby and standby to primary, respectively. The objective is to verify the capacity of each processor to take over in case the other processor becomes inoperative. With Unity Pro XLS, this function can easily be programmed in the application by implementing the S_HSBY_SWAP elementary function from the library.

Distinctive features and specific procedures

Auto-testing software tools

Unity™ Pro XLS provides the option of performing an auto-test to verify that the software components installed have not been corrupted, for example, due to a hard disk failure. This auto-test is based on a CRC calculation.

Unity Pro XLS checks the version and CRC of:

- DLLs
- Library database of the safety FFB
- Catalog database of hardware products

Unity Pro XLS auto-tests are performed upon request by the user, for example:

- After installing or uninstalling any program on the computer
- Before loading the final application program onto the SIL3 Quantum™ PLC
- Before modifying the application program executed on the SIL3 Quantum PLC

Time-stamping binary files

With Unity Pro XLS, every binary file generated for a safety project features a version management field that provides the date and time when it was generated. This information is useful for checking the project.

Downloading a project to Unity Pro XLS

It is possible to download a safety project from the PLC to Unity Pro XLS under the following conditions:

- This must have been defined as an option for the safety project.
- The user must know the application password to establish a connection to the safety PLC.
- The safety PLC must be placed in maintenance mode to perform the download.

Unrestricted memory

The unrestricted memory area contains bits and words that are not protected against write operations from external equipment such as HMI terminals, PLCs, etc.

- It is located at the beginning of the memory.
- Its size can be configured with Unity Pro XLS.
- Values cannot be used directly in the unrestricted memory area and can only be used in conjunction with specific function blocks: S_MOVE_BIT and S_MOVE_WORD.

Unity Pro XLS checks in the edit phase and then in the generation phase to make sure that only data from the unrestricted memory area are used at the input of the function blocks S_MOVE_BIT and S_MOVE_WORD.

Unity Pro XLS provides a list of useful cross references, which allows easy identification of how variables are used and verification of the application.

Note: For safety applications, it is common practice to verify the correct transfer of data by writing the data twice (to two different variables) and then comparing them.

Modicon® M340™ automation platform

Unity™ Pro software

Small / Medium / Large / Extra Large / XLS

Communication drivers

The drivers used most frequently with the Atrium™, Premium™, and Quantum™ platforms are installed at the same time as the Unity™ Pro software.

Unity Pro also includes the following communication drivers that can be installed as required (1):

Driver type	Windows XP® Windows 2000®	Windows NT®	Windows 98 Millenium®	Windows 95®
Uni-Telway™ COM port	V1.9 IE20	V1.9 IE17	V1.7 IE18	V7.8 IE18
Uni-Telway™ TSX SCP 114	V1.2 IE05			
Modbus® COM port	V1.6 IE29			
Fip ISA TSX FPC10 card	V1.4 IE06	V1.3 IE08	V1.4 IE06	V2.4 IE08
Fip PCMCIA TSX FPC20 card	V1.2 IE03	V1.1 IE08	V1.2 IE04	
Ethway™	V1.4 IE05	V1.1 IE03	V2.6 IE06	
ISAway™ PCX 57, ISA card	V1.2 IE04	V1.5 IE06	V1.2 IE04	V1.2 IE09
PClway™ Atrium, PCI card	V1.1 IE09	-		
XIP X-Way on TCP	V1.10 IE22			
USB for USB terminal port	V1.2 IE17	-		

4

Unity™ Developer's Edition, advanced open access

Advanced open access, intended for experienced IT engineers, supports the development of interfaces between Unity™ and expert tools, as well as specific user-defined functions.

This type of development requires experience in the following IT areas:

- C++ or Microsoft® Visual Basic® languages
- Client/server architectures
- XML and COM/DCOM technologies
- Database synchronization

As a supplement to the Unity™ Pro Extra Large software (2), the UDE (Unity Developer's Edition) development kit **UNY UDE VFU CD21E** enables the development of customized solutions. In addition to the development kit, the Unity servers and accompanying documentation are also provided.

Unity Developer's Edition is compatible with:

- Unity™ Pro Extra Large
- Modicon® M340™ processors
- Atrium™ slot-PLCs
- Premium™ Unity processors
- Quantum™ Unity processors

(1) Also available separately under reference **TLX CD DRV 20M**.

(2) Only the Unity™ Pro Extra Large version enables dynamic database management for data to be exchanged with the OFS data server or a third-party tool.

Modicon® M340™ automation platform

Unity™ Pro software

Small / Medium / Large / Extra Large / XLS

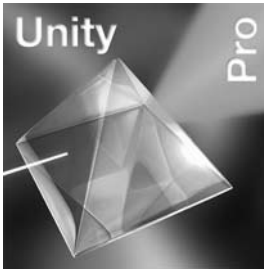

References

Unity™ Pro Small, Medium, Large, Extra Large, and XLS software packages

The software is available in 5 versions:

- **Unity Pro Small** for programming and configuring Unity automation platforms:
 - Modicon® M340™ BMX P34 1000 and BMX P34 20●0
- **Unity Pro Medium** for programming and configuring Unity automation platforms:
 - Modicon M340 BMX P34 1000 and BMX P34 20●0
 - Atrium™ TSX PCI 57 20
 - Premium™ TSX 57 0●, 57 10, and 57 20
- **Unity Pro Large** for programming and configuring Unity automation platforms:
 - Modicon M340 BMX P34 1000 and BMX P34 20●0
 - Atrium TSX PCI 57 20 and 57 30
 - Premium TSX 57 0●, 57 10, 57 20, 57 30, and 57 40
 - Quantum™ with processors 140 CPU 311 10, 434 12U, and 534 14U
- **Unity Pro Extra Large** for programming and configuring all Unity automation platforms:
 - Modicon M340 BMX P34 1000 and BMX P34 20●0
 - Atrium TSX PCI 57 20 and 57 30
 - Premium TSX 57 0●, 57 10, 57 20, 57 30, 57 40, 57 50, and 57 60
 - Quantum with processors 140 CPU 311 10, 434 12U, 534 14U, 651 50, 651 60, 652 60, and Hot Standby 140 CPU 671 60
- **Unity Pro XLS** for programming and configuring all Unity and SIL3 Quantum automation platforms:
 - Modicon M340 BMX P34 1000 and BMX P34 20●0
 - Atrium TSX PCI 57 20 and 57 30
 - Premium TSX 57 0●, 57 10, 57 20, 57 30, 57 40, 57 50, and 57 60
 - Quantum with processors 140 CPU 311 10, 434 12U, 534 14U, 651 50, 651 60, 652 60, and Hot Standby 140 CPU 671 60
 - Quantum with safety processors 140 CPU 651 60S and Hot Standby 140 CPU 671 60S

Upgrade kits for Concept™, PL7™ Pro, and ProWORX™ software

These upgrade kits allow users who already have these software programs installed and who have a **current subscription** to obtain Unity™ Pro version V4.0 software at a reduced price. These upgrades are only available for licenses of the same type (from Concept™ XL license group to Unity Pro Extra Large license group).

Composition and Windows® OS compatibility

Unity Pro multilingual software packages are compatible with Windows 2000® Professional and Windows XP® operating systems.

They comprise the following elements:

- Documentation in electronic format in 6 languages (English, German, Chinese, Spanish, French, and Italian)
- Converters for converting applications created with Concept™ and PL7™ Pro programming software
- PLC simulator

Cables for connecting the processor to the programming PC must be ordered separately.

Modicon® M340™ automation platform

Unity™ Pro software
Small / Medium

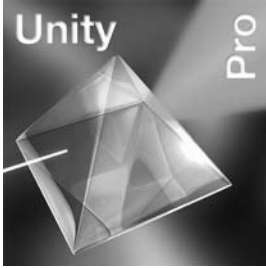

Unity™ Pro Small version 4.0 software

For PLCs: **BMX P34 1000** **BMX P34 20●0**

Unity™ Pro Small version 4.0 software packages

Description	License type	Reference	Weight kg
Unity™ Pro Medium software packages	Single (1 station)	UNY SPU SFU CD 40	–
	Group (3 stations)	UNY SPU SFG CD 40	–
	Team (10 stations)	UNY SPU SFT CD 40	–
Software upgrades from: - Concept™ S - PL7™ Micro - ProWORX™ NxT/32 Lite	Single (1 station)	UNY SPU SZU CD 40	–
	Group (3 stations)	UNY SPU SZG CD 40	–
	Team (10 stations)	UNY SPU SZT CD 40	–

License type extension for Unity Pro Small software

From	To	Reference	Weight kg
Single (1 station)	Group (3 stations)	UNY SPU SZUG CD 40	–
Group (3 stations)	Team (10 stations)	UNY SPU SZGT CD 40	–

Unity™ Pro Medium version 4.0 software

For PLCs: **BMX P34 1000** **TSX 57 0●...57 20**
BMX P34 20●0 **TSX PCI 57 20**

Unity™ Pro Medium version 4.0 software packages

Description	License type	Reference	Weight kg
Unity Pro Medium software packages	Single (1 station)	UNY SPU MFU CD 40	–
	Group (3 stations)	UNY SPU MFG CD 40	–
	Team (10 stations)	UNY SPU MFT CD 40	–
Software upgrades from: - Concept S, M - PL7 Micro, Junior - ProWORX NxT/32 Lite	Single (1 station)	UNY SPU MZU CD 40	–
	Group (3 stations)	UNY SPU MZG CD 40	–
	Team (10 stations)	UNY SPU MZT CD 40	–

License type extension for Unity Pro Medium software

From	To	Reference	Weight kg
Single (1 station)	Group (3 stations)	UNY SPU MZUG CD 40	–
Group (3 stations)	Team (10 stations)	UNY SPU MZGT CD 40	–

Software upgrade from Unity Pro Small to Unity Pro Medium software

License type	Reference	Weight kg
Single (1 station)	UNY SPU MZSU CD 40	–
Group (3 stations)	UNY SPU MZSG CD 40	–
Team (10 stations)	UNY SPU MZST CD 40	–

Modicon® M340™ automation platform

Unity™ Pro software
Large / Extra Large



Unity™ Pro Large version 4.0 software

For PLCs:	BMX P34 1000	140 CPU 311 10
	BMX P34 20●0	140 CPU 434 12U
	TSX 57 0●...57 40	140 CPU 534 14U
	TSX PCI 57 20/30	

Unity™ Pro Large version 4.0 software packages

Description	License type	Reference	Weight kg
Unity™ Pro Large software packages	Single (1 station)	UNY SPU LFU CD 40	–
	Group (3 stations)	UNY SPU LFG CD 40	–
	Team (10 stations)	UNY SPU LFT CD 40	–
	Site (≤ 100 users)	UNY SPU LFF CD 40	–
Software upgrades from: - Concept™ S, M - PL7™ Micro, Junior, Pro - ProWORX™ NxT/32 Lite	Single (1 station)	UNY SPU LZU CD 40	–
	Group (3 stations)	UNY SPU LZG CD 40	–
	Team (10 stations)	UNY SPU LZT CD 40	–
	Site (≤ 100 users)	UNY SPU LZF CD 40	–

License type extension for Unity Pro Large software

From	To	Reference	Weight kg
Single (1 station)	Group (3 stations)	UNY SPU LZUG CD 40	–
Group (3 stations)	Team (10 stations)	UNY SPU LZGT CD 40	–

Software upgrade from Unity Pro Medium to Unity Pro Large software

License type	Reference	Weight kg
Single (1 station)	UNY SPU LZSU CD 40	–
Group (3 stations)	UNY SPU LZSG CD 40	–
Team (10 stations)	UNY SPU LZST CD 40	–

Unity™ Pro Extra Large version 4.0 software

For PLCs:	BMX P34 1000	140 CPU 434 12U
	BMX P34 20●0	140 CPU 534 14U
	TSX 57 0●...57 60	140 CPU 651 50/60
	TSX PCI 57 20/30	140 CPU 652 60
	140 CPU 311 10	140 CPU 671 60

Unity™ Pro Extra Large version 4.0 software packages

Description	License type	Reference	Weight kg
Unity Pro Extra Large software packages	Single (1 station)	UNY SPU EFU CD 40	–
	Group (3 stations)	UNY SPU EFG CD 40	–
	Team (10 stations)	UNY SPU EFT CD 40	–
	Site (≤ 100 users)	UNY SPU EFF CD 40	–
Software upgrades from: - Concept S, M, XL - PL7 Micro, Junior, Pro - ProWORX NxT Lite, Full - ProWORX 32 Lite, Full	Single (1 station)	UNY SPU EZU CD 40	–
	Group (3 stations)	UNY SPU EZG CD 40	–
	Team (10 stations)	UNY SPU EZT CD 40	–
	Site (≤ 100 users)	UNY SPU EZF CD 40	–

License type extension for Unity Pro Extra Large software

From	To	Reference	Weight kg
Single (1 station)	Group (3 stations)	UNY SPU EZUG CD 40	–
Group (3 stations)	Team (10 stations)	UNY SPU EZGT CD 40	–

Software upgrade from Unity Pro Large to Unity Pro Extra Large software

License type	Reference	Weight kg
Single (1 station)	UNY SPU EZSU CD 40	–
Group (3 stations)	UNY SPU EZSG CD 40	–
Team (10 stations)	UNY SPU EZST CD 40	–

Modicon® M340™ automation platform

Unity™ Pro software
XLS

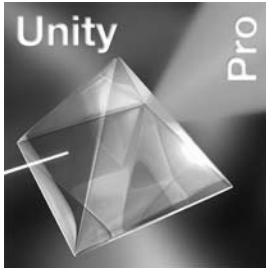

Unity™ Pro XLS version 3.1 software

For PLCs:	BMX P34 1000	140 CPU 534 14U
	BMX P34 20●0	140 CPU 651 50/60
	TSX 57 0●...57 60	140 CPU 652 60
	TSX PCI 57 20/30	140 CPU 671 60
	140 CPU 311 10	140 CPU 651 60S
	140 CPU 434 12U	140 CPU 671 60S

Unity™ Pro XLS version 3.1 software packages

Description	License type	Reference	Weight kg
Unity™ Pro XLS software packages	Single (1 station)	UNY SPU XFU CD 31	–
	Group (3 stations)	UNY SPU XFG CD 31	–
	Team (10 stations)	UNY SPU XFT CD 31	–
	Site (≤ 100 users)	UNY SPU XFF CD 31	–
Software upgrades from:	Single (1 station)	UNY SPU XZU CD 31	–
	Group (3 stations)	UNY SPU XZG CD 31	–
	Team (10 stations)	UNY SPU XZT CD 31	–
	Site (≤ 100 users)	UNY SPU XZF CD 31	–
	- Concept™ S, M, XL - PL7™ Micro, Junior, Pro - ProWORX™ NxT Lite, Full - ProWORX™ 32 Lite, Full		

4

Software for Unity™ Pro version 3.1

Unity™ Developer's Edition

For PLCs:	BMX P34 1000	140 CPU 534 14U
	BMX P34 20●0	140 CPU 652 60
	TSX 57 0●...57 60	140 CPU 671 60
	TSX PCI 57 20/30	140 CPU 651 60S
	140 CPU 311 10	140 CPU 671 60S
	140 CPU 434 12U	

Description	License type	Reference	Weight kg
UDE Unity™ Developer's Edition, Requires Unity™ Pro Extra Large or Unity™ Pro XLS	Single (1 station)	UNY UDE VFU CD21E	–

References (continued)

Documentation for Unity™ Pro version 3.1

For PLCs	Description	License type	Reference	Weight kg
Hardware and software manuals (on DVD)	Platform setup for: - Modicon® M340™ - Atrium™/Premium™ - Quantum™ - Momentum™ - Compatible platforms Electromagnetic compatibility of networks and fieldbuses Software setup for: - Unity™ Pro - Function block library	Multilingual: English, German, Chinese, Spanish, French	UNY USE 909 CD M	–

Separate parts

Description	From Processor	To PC port	Length	Reference	Weight kg
PC terminal connection cables	USB mini B port BMX P34 1000/20●0	USB port	1.8 m	BMX XCA USB H018	0.065
			4.5 m	BMX XCA USB H045	0.110
	Mini-DIN port Premium™ TSx 57 1●/2●/3●/4● Atrium™ TSX PCI 57	RS 232D (9-pin D-SUB connector)	2.5 m	TSX PCX 1031	0.170
			0.4 m	TSX CUSB 485 (1)	0.144
			2.5 m	TSX CRJMD 25 (1)	0.150
	Modbus® port 15-pin D-SUB Quantum 140 CPU 311 10 140 CPU 434 12A 140 CPU 534 14A	RS 232D (15-pin D-SUB connector)	3.7 m	990 NAA 263 20	0.300
			15 m	990 NAA 263 50	0.180
	USB port Premium TSX 57 5●/6● Quantum 140 CPU 6●1	USB port	3.3 m	UNY XCA USB 033	–
	Modbus® port, RJ45 connector Quantum 140 CPU 6●1	RJ45 connector	1 m	110 XCA 282 01	–
			3 m	110 XCA 282 02	–
			6 m	110 XCA 282 03	–

(1) Use the TSX CRJMD 25 mini-DIN/RJ45 cordset with the TSX CUSB 485 converter.



BMX XCA USB H0●●



TSX PCX 1031



TSX CUSB 485

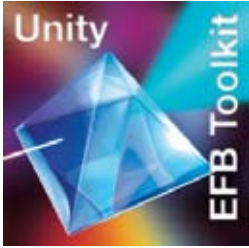

Introduction

Unity™ EFB Toolkit is the software for developing EFs and EFBs in C language and is optional software for Unity Pro. It can be used to develop new functions (internal code is written in C language) to extend and complete the set of functions proposed as standard in Unity Pro. This software comes with *Microsoft Visual-C++ @.Net* that can be used to debug the functions used on the Unity Pro PLC simulator. Unity EFB Toolkit also includes a service for creating and managing families of functions, with a view to their integration in the Unity Pro function libraries.

Setup

C language development software is a proper tool for managing the whole function while it is being performed:

- A user-friendly creation interface, integrated in Unity Pro, with automatic file organization
- Powerful tools for testing and debugging
- Management of compatibilities and software versions of created functions
- Generation of files for subsequent installation of functions on other development stations

Managing function families

The software can be used to define different function families. These functions, also known as EFs/EFBs, are stored in families, making it possible to create an organized library of functions written in C language.

Once created, these families can be distributed and integrated in the Unity Pro libraries.

They are:

- Arranged in families/functions
- Used in each languages with the same flexibility as standard functions (data entry wizard)
- Managed by the Unity Pro library tool (version management)

Editing functions

The various tabs in the EFB Toolkit software editor allow the user to create the function by:

- Declaring the interface; all data types are possible (elementary, structures, tables)
- Supporting public and private variables

Writing the source code file in C language

A function written in C language can access numerous internal PLC services such as the real-time clock, PLC variables, system words and math functions. In particular, it is possible to perform numerical processing in floating point format.

4

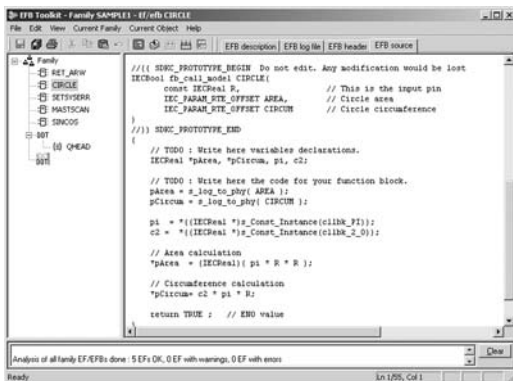
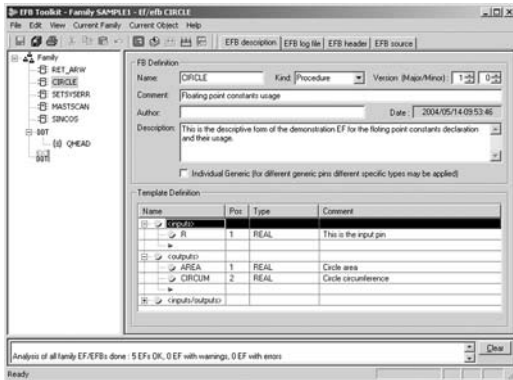

Setup (continued)

Debugging functions

The created function can be tested after it has been inserted in an application and loaded into the Unity™ Pro PLC simulator.

The Microsoft® Visual C++® tool is used to debug the function and to:

- Insert breakpoints
- Perform step-by-step execution
- Display the code with the breakpoints visible
- Display manipulated data

Note: To generate the code for a Modicon® M340™ platform, a specific GNU compiler is used. It is supplied with the Unity EFB Toolkit.

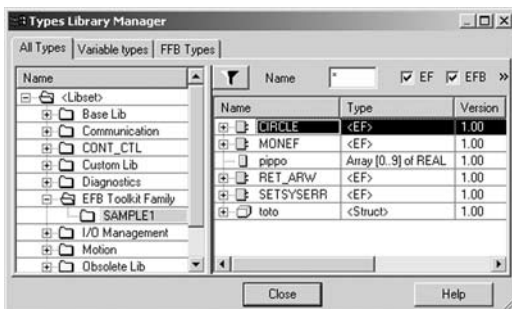

Enhancing the function library

After the function has been debugged, it can be generated and distributed and the updating tool supplied with Unity Pro can be used to enhance the libraries on a user station.

Version management means that the user knows the level of functions installed on a station and can update the application with the most recent versions.

Compatibility

Unity EFB Toolkit is compatible with Unity Pro Small, Medium, Large and Extra Large.

EFs and EFBs can be developed for the Modicon® M340™, Premium™, Atrium™ and Quantum™ platforms.

Reference

Unity EFB Toolkit is "companion" software for Unity Pro and is used to create EFs and EFBs. These are developed in Visual C++ language and are integrated in Unity Pro function block libraries.

The Unity EFB Toolkit software and its documentation are supplied in electronic form on CD-ROM in English.

Description	License type	Language	Reference	Weight kg
Unity™ EFB Toolkit for developing EFs and EFBs	Single (1 station)	English (software and electronic documentation)	UNY SPU ZFU CD 30E	–

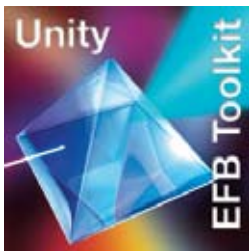

Modicon® M340™ automation platform

Unity™ software

Unity SFC View software

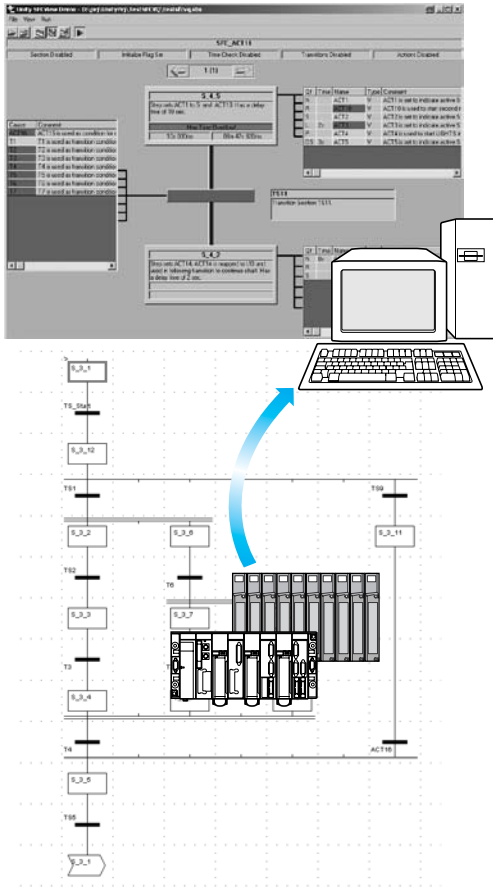

Introduction

Unity™ SFC View is integrated in human/machine interface (HMI) applications for monitoring Unity Pro sequential applications written in sequential function chart language (SFC or Grafset™) executed by a PLC.

Set up in the same way as a Microsoft® ActiveX® control component, Unity SFC View is used to display status information relating to SFC charts executed by a Modicon® M340™, a Premium™ or a Quantum™ PLC. Installed on an HMI station, Unity SFC View monitors and controls the status of SFC charts in real time, supplying detailed diagnostic data.

Unity SFC View reads the necessary data from the Unity project database in offline mode. The PLC data is accessed online via the OFS (OPC Factory Server).

Without needing to recreate SFC charts in the HMI environment, Unity SFC View reads the structure of the SFC charts directly from the Unity project database. Modifications made to the SFC application are detected and updated at any time. In online mode, Unity SFC View accesses the PLC diagnostic data, which enables awareness and tracks the occurrence of the first detected fault and subsequent detected faults. System downtime is reduced since Unity SFC View enables maintenance staff to locate the source of the problem more quickly.

Unity SFC View is designed for end users and system designers who wish to integrate this control into their HMI system. Unity SFC View is compatible with most HMI platforms handling ActiveX Control components such as Vijeo® Designer™ control software (on PC platform) or in a programming environment such as Microsoft® Visual Basic®.

The 3 Unity™ SFC View views

Unity™ SFC View offers 3 views:

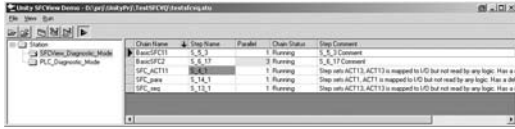

Overview

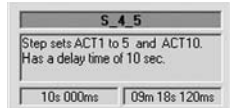

Simple detailed view

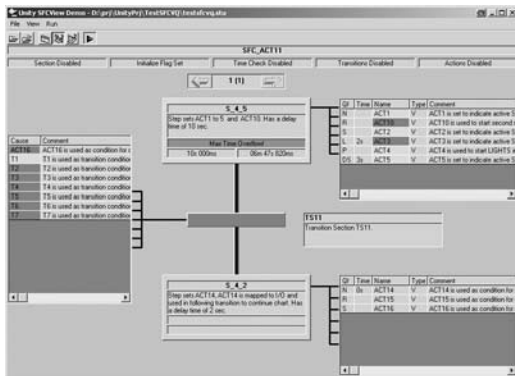

Detailed view

■ **The overview** provides a general view of the SFC charts in a Unity project. It contains real-time data such as current step, simultaneous steps, chart detected error with indication of the SFC chart status. The overview makes it easy to browse through SFC charts and switch quickly to the detailed view of the desired SFC chart in the Unity Pro application.

■ **The simple detailed view** shows the elementary data on the active step (or selected step) of the SFC chart in real time. The data displayed may include the name, comment, chart and step status, as well as the activity times (min, max, actual). You can also enable the chart navigation option.

Because of the compact size of the simple detailed view, it is possible to place several instances of it on a single HMI screen relating to a certain part of the process. From this simple detailed mode, you can navigate between HMI screens with SFC View controls and display the detailed view of SFC charts.

■ **The detailed view** illustrates the details of an SFC chart in real time. The display indicates the current step, the transition awaiting activation and the next step. The actions associated with the steps are displayed along with sequence selections or parallel branches. The detailed diagnostic data includes analysis of the causes of the fault at transition level. Depending on the diagnostic mode, the error grid contains the causes of detected fault or the variables assigned to the transition logic. The current state of the various variables and selected error entries are identified by different colors.

Diagnostic mode

Transition logic diagnostics is a key function of Unity SFC View. It minimizes system downtimes in the event of a detected fault.

Two different diagnostic modes are available:

■ Unity SFC View reads the data in the Unity PLC diagnostic buffer. It provides information about incorrect or missing events that are preventing the transition from being enabled. This mode does not require any configuration or additional programming in the PLC program.

■ Unity SFC View monitors the internal logic of the transition conditions “back to front”. This mode provides diagnostic data concerning the inputs connected to the transition (not limited to inoperative inputs). In this mode, for Premium™, Atrium™ and Quantum™ platforms, Unity SFC View uses specific EFB function blocks linked to the transition conditions. The library for these blocks is supplied with the Unity SFC View software.

Customization

Unity SFC View offers a programming interface that can be used to integrate the Microsoft® ActiveX® Control component in an HMI application and customize its functions and its operator interface.

The ActiveX Control component in Unity SFC View can be customized. It accepts properties, methods and events (the properties have a default value). The properties pages simplify configuration. Unity SFC View accepts scripts with methods such as browsing through charts, status control of charts, and also events such as detected error notification or chart selection. This data can be used to launch programs or operator screens.

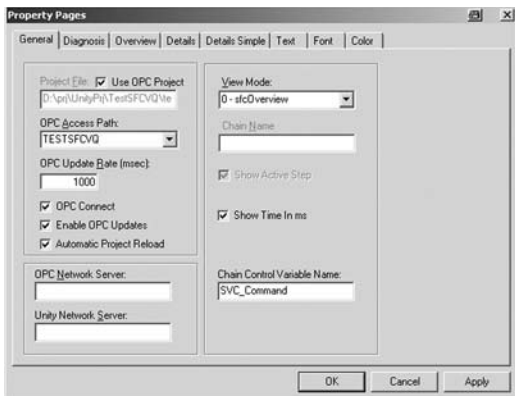

SFC View properties page



Modicon® M340™ automation platform

Unity™ software

Unity SFC View software

Possible architectures

Basic architecture

Unity™ SFC View is used in a configuration where the OFS and Unity Pro software reside on the same PC platform as the HMI application.

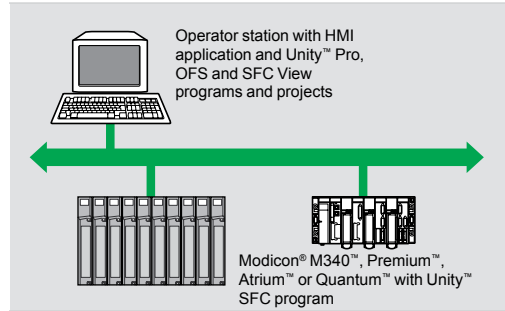

Distributed architecture

In a distributed configuration, the OFS and Unity Pro software can be installed on different servers.

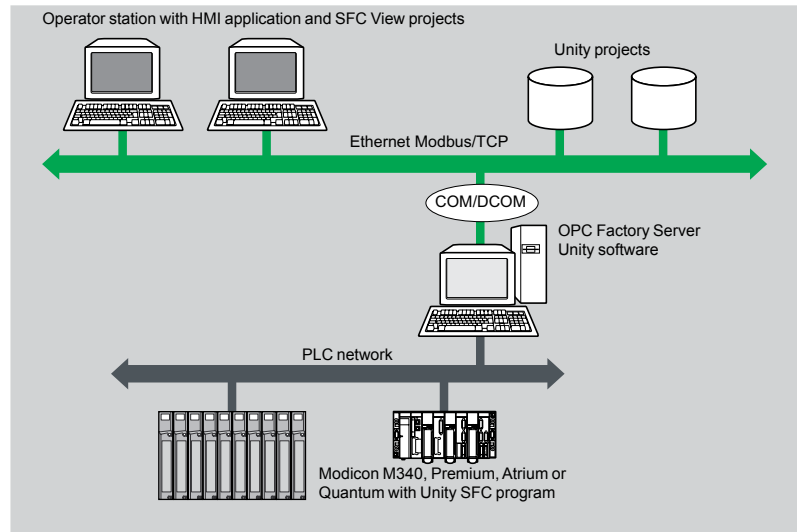

Modicon® M340™ automation platform

Unity™ software

Unity SFC View software



References

When integrated in an HMI application, Unity™ SFC View can be used to monitor and control charts in applications developed in Sequential Function Chart (SFC) language running on Premium™/Quantum™ Unity PLCs.

The HMI station, compatible with Microsoft® Windows 2000® or Windows XP® Professional operating systems, must support Microsoft® ActiveX® Control components. Unity SFC View V2.0 requires:

- Unity Pro V3.● XL, to be ordered separately
- OFS V3.3 data server software, to be ordered separately

Unity SFC View multilingual software, supplied on a CD-ROM, includes:

- The SFC View ActiveX Control component
- The EFB function block library for Unity Pro V3.●
- An example of how to integrate SFC View in Unity Pro projects
- The electronic documentation (English, French and German)

The Unity SFC View integration example illustrates the main possibilities offered by Unity SFC View. This is an executable program that does not need HMI software to run. It helps the user understand how to configure and use the Unity SFC View ActiveX Control component.

Description	Type of license	Reference	Weight kg
Unity™ SFC View software packages (version V2.0)	Single (1 station)	UNY SDU MFU CD20	–
	Team (10 stations)	UNY SDU MFT CD20	–
	Site (100 stations)	UNY SDU MFF CD20	–

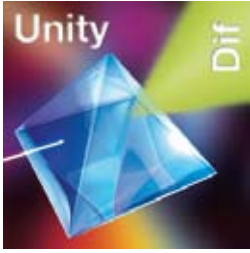

Introduction

Unity™ Dif application comparison software for Modicon® M340™/Premium™/Atrium™/Quantum™ platforms is an optional program that complements the Unity Pro Extra Large programming software. It is used to compare two Unity applications generated by Unity Pro and automatically provide an exhaustive list of the differences between them.

The Unity Dif program increases productivity in the main life phases of a control system based on Modicon M340/Premium/Atrium/Quantum platforms:

- Application development and debugging
- Starting up installations and processes
- Operation and maintenance of installations and processes

Unity Dif software is an efficient tool for handling Unity applications for:

- Control system design offices
- Operation and maintenance managers
- Installers and systems integrators

Software setup

Unity Dif software can be used in one of two modes:

- Interactive mode, when the comparison is launched in Unity Pro Extra Large by an operator command (double-click on the Unity Dif software icon)
- Automatic mode, when it is launched by a previously established call command

These comparison commands locate the differences between two applications in terms of:

- The hardware configuration (Modicon M340/Premium/Atrium/Quantum)
- The network configuration (Ethernet TCP/IP network, CANopen bus and RIO remote I/O (1))
- The entire set of variables and function block instances
- The application structure and its content (regardless of the language(s) used)
- The function modules
- The code for the DFBs and DDTs
- The project options

The result of the comparison between the two applications can be:

- Displayed
- Printed
- Saved in .txt format in a report listing the differences

Comparison

The end of the comparison operation is signalled by the appearance of the application browser with its two tabs:



1 Identification tab for accessing the specifications of the two applications being compared. The differences are marked by the # sign.

2 Browser tab for accessing the application multilevel tree structure.

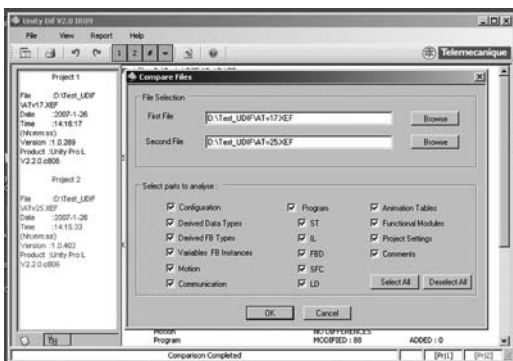

(1) Remote I/O for Modicon® Quantum™ platform

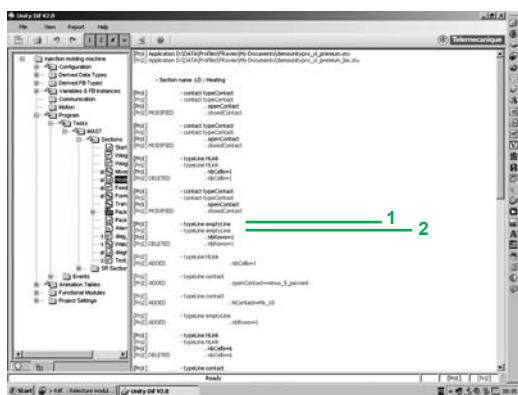

Setup (continued)

Displaying results

The reintroduction of the application multilevel tree structure can be accessed via the browser tab after launching a comparison and is annotated by 4 symbols. The information associated with application 1 will appear in blue and the information associated with application 2 will appear in red:



This branch, found in this level of the tree structure, contains at least one difference



This block contains at least one difference



This section is only present in application 1



This section is only present in application 2

In the example to the left, a difference on the rung causing changeover to manual mode is detected:

1 The line displayed in blue belongs to application 1 [Prj1]

2 The line displayed in red belongs to application 2 [Prj2]

The source code extracts of both applications can be used to locate the differences precisely.

Generating the differences report

The "Report" command is used to generate the report file (.txt):

```
Compared Files:
[Prj1] D:\Test_UDIF\ATV17.XEF
[Prj2] D:\Test_UDIF\ATV25.XEF

Date/Time of ReportGeneration: 26/03/2007 10:16:13
Machine Name : so-Fravier
Windows Username : FR.ACC\Fravier

First file : D:\Test_UDIF\ATV17.XEF
Name : OA604
Size : 4163,72 KB
Date : 2007-1-26 (yyyy-mm-dd)
Time : 14:16:17 (hh:mm:ss)
Version : 1.0.289
Product : Unity Pro L V2.2.0.c806
Company : Schneider Automation
PLC Address : {2.0}SVS, XIP01

Second file : D:\Test_UDIF\ATV25.XEF
Name : OA604
Size : 4183,58 KB
Date : 2007-1-26 (yyyy-mm-dd)
Time : 14:15:33 (hh:mm:ss)
Version : 1.0.403
Product : Unity Pro L V2.2.0.c806
Company : Schneider Automation
PLC Address : {2.0}SVS, XIP01

Compared Part(s):
Configuration MODIFIED : 0 ADDED : 21 DELETED : 21
Derived Data Types NO DIFFERENCES
Derived FB Types MODIFIED : 51 ADDED : 27 DELETED : 24 MOVED : 0
Variables & FB Instances MODIFIED : 29 ADDED : 71 DELETED : 2
Communication MODIFIED : 0 ADDED : 0 DELETED : 2
Motion NO DIFFERENCES
Program NO DIFFERENCES
Function Block Diagram ADDED : 0 DELETED : 0 MOVED : 0
Ladder Diagram MODIFIED : 48 ADDED : 93 DELETED : 70
Structured Text MODIFIED : 276 ADDED : 383 DELETED : 446
Instruction List MODIFIED : 433 ADDED : 4291 DELETED : 4195 MOVED : 0
Sequential Function Chart NO DIFFERENCES
Animation Tables MODIFIED : 0 ADDED : 60 DELETED : 24 MOVED : 0
Functional Modules MODIFIED : 23 ADDED : 0 DELETED : 0 MOVED : 0
Project Settings NO DIFFERENCES

Non compared part(s) :

Filters :
Shown : 1, 2, #
Hidden : =

Report in Tree View:
( )OA604
|--( #)Configuration
|   |--( #)0: XBus
|   |   |--( #)1: TSXRY12
|   |   |--( #)2: TSXPS74634M
|   |   |--( #)3: TSXETV4103
|   |--( #)Derived Data Types
|   |--( #)Derived FB Types
|   |--( #)RESS_DE_3F_TEST
|   |--( #)Regulation
```



References

This software extension used to compare two PL7 applications generated by Unity™ Pro software version ≥ V2.1

Function	Target extension PLC target	Type of device	Reference	Weight kg
Unity Dif™ application comparison software extension	Unity™ Pro Extra Large Modicon® M340™	Single (1 station)	UNYSDU DFU CD20	–
CD-ROM containing software atnd electronic documentation (English-French)	Premium™/Atrium™ Quantum™			



Introduction

Unity Loader™ is companion software to Unity Pro and is used to perform maintenance operations on automation applications. Its easy setup and the small size of its executable make it an essential tool for updating Modicon® M340™ PLC projects when it is not necessary to read or modify the program. It is also essential software for updating the embedded software on the M340 PLC. It performs the following two main functions:

- Transfer of automation project components from the PC to the PLC or from the PLC to the PC, such as the program, data, files and user Web pages stored in the memory cartridge.
- Transfer of embedded software (firmware) from the PC to Modicon M340 modules.

Software graphic interface

The software is designed for use by people with limited automation expertise. The interface consists of four tabs, with buttons within each of the tabs to perform different operations.

- The “Project” tab is used for project transfers: program, data and user files. The three exchange operations between the PC and the processor can be sequenced together in a single command.
- The “Operating System” tab is used to update the embedded software in the PLC. The screen displays the detailed content of the PLC firmware versions, and, when a file is selected on the PC, the specifications of that file are displayed.
- The “Options” tab is used to configure the working environment, including the location of files on the PLC, selection of one of six languages (English, French, German, Italian, Spanish, Chinese) for the interface and online help, etc.
- The “About” tab is used to display information about the software.

Note: The connection status with the PLC is displayed on each tab, with commands for connection/disconnection and changing the PLC operating mode.

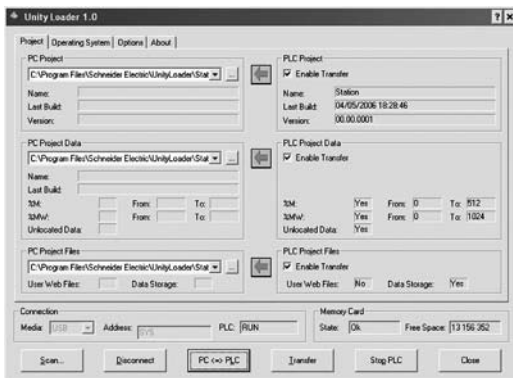

Unity™ Loader “Project” tab

Modicon® M340™ PLC project transfer

Exchanges between the PC and the PLC processor

The software can be used to transfer the components of a project in either direction:

- Program: binary and source, if the application has been built using the source format
- Data file: located and unlocated data
- Data on **BMX RMS ●●8MFP** memory cartridge: user files.

Unity™ Pro can be used to transfer the application from either the application file .stu, or the archive file .sta. The program file and data formats, together with the functions performed by Unity Loader, are identical to those built and used by Unity Pro.

When the cartridge-based user files are transferred from the PLC to the PC, a private file specific to Unity Loader is created. The operation is then possible in the other direction. Unity Pro cannot be used to perform this type of transfer.

To simplify project management, Unity Loader defaults to store the three files read in the PLC in the same directory with an identical file name (the project name by default), but with a different file extension. The default choice suggested can be modified by the user.

Once connected to the PLC, Unity Loader displays the specifications of the data read in the PLC. Similarly, when the files are selected on the PC, the corresponding specifications are also displayed. The data necessary to decide on the action required is displayed on a single screen. The three components of the project are selected by default, provided that they are valid for the chosen direction of transfer. Transfer of one or two of the components can be disabled. The transfers are performed in a single command.

Exchanges to remote PLC via Flash memory card

Unity Loader software also permits downloads on a flash memory card (slotted in the processor) the components of a project (program, located and unlocated data and/or user files) and one firmware of Modicon M340 modules (processor, analog, counter, motion control or communication).

This firmware download allows updates to a remote PLC configuration at a later time.

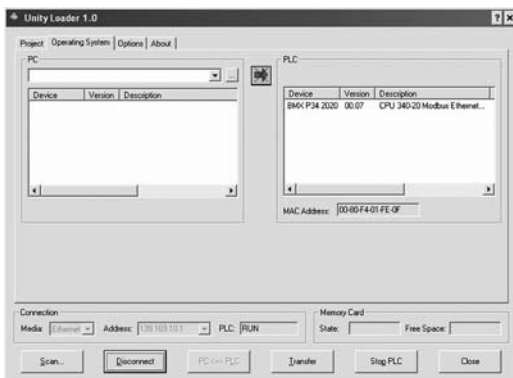

Unity Loader “Operating System” tab

Modicon® M340™ PLC project transfer (continued)

Transfer of user Web pages of Ethernet network module

The **BMX NOE 0110** Ethernet module contains a Flash memory card that can store user Web pages. When Unity™ Loader is connected to the communication module, web pages can be transferred from the module to the PC or vice versa. The operating mode is identical to that available for exchanges with the processor.

Firmware updating of Modicon® M340™ modules

Firmware of Modicon® M340™ modules (processor, analog, counter, motion control and communication) can be updated by following the same principle as that used to manage projects.

Once connected to the PLC, Unity Loader displays the specifications of the firmware read in the PLC. Similarly, when a file that fits to a valid firmware file is selected on the PC, the corresponding specifications are displayed. The necessary data to decide whether the update should be performed are displayed on a single screen.

Communication between the PC and the PLC

Unity Loader uses two communication means, USB and Ethernet:

- USB is always available for exchanges with the PLC module.
- Ethernet is essential for exchanges with the Ethernet modules and can also be used for exchanges with processors that have an integrated Ethernet port.

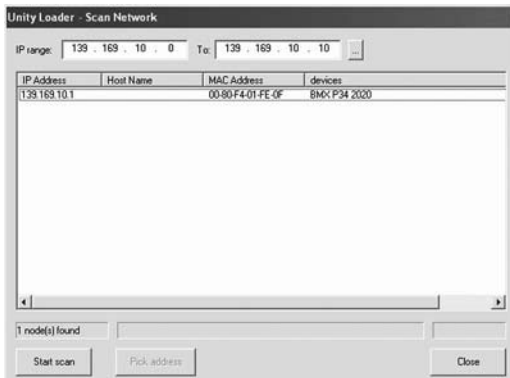

Unity™ Loader Network scanning

Reference	Type of module	Ethernet port	USB port
BMX P34 1000	Processor with Modbus®		
BMX P34 2000			
BMX P34 2010	Processor with CANopen		
BMX P34 2020	Processor with integrated Ethernet port		
BMX P34 2030			
BMX NOE 0100/0110	Ethernet Modbus/TCP		
BMX AMI/ART/AMO/AMM	Analog I/O		
BMX EHC 0200/0800	Counter		
BMX MSP 0200	Motion control		

Supported Supported if processor with integrated Ethernet port

When Unity Loader is connected to an Ethernet network, it is possible to define a range of addresses to be scanned and to display the devices recognized on the network. By selecting the Modicon M340 PLC, the transfer operations can be performed.

Connection, transfer operations, and any detected errors are recorded in a trace file stored in the PC.

Automation of Unity™ Loader controls

Project download/upload between a PLC and a PC equipped with a supervisory software and Unity Loader software is possible through a batch file managed by the supervisory application.

Reference

Unity Loader is available in two formats. It is automatically provided with all versions of Unity™ Pro Small, Medium, Large and Extra Large. It can be ordered separately using the unit reference provided below.

Compatibility

Unity Loader is compatible with Modicon M340 PLCs. Its use is totally independent of Unity Pro.

Program files and PLC data are compatible between Unity Pro and Unity Loader.

Description	Type	Reference	Weight kg
Unity™ Loader	Single license	UNY SMU ZUCD20	–



Modicon® M340™ automation platform

Vijeo® Citect® supervisory software

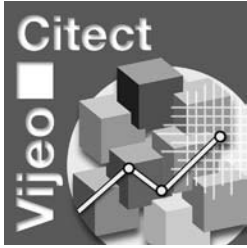

Web-enabled Power & Control
Transparent
Ready®

Introduction

The flexibility of Vijeo® Citect® supervisory software enables users to achieve the solution that best suits their supervision requirements for installations.

Vijeo Citect offers the functions of a modern supervisor. Its distributed client-server architecture is applicable to a multitude of applications in the varied segments:

- Oil and Gas
- MMM, Mining, Metals and Minerals
- WWW, Water and Washwater treatment
- Power
- Food and Beverage

The Vijeo Citect flexibility allows it to meet the requirements in many other applications like tunnels and airports.

A unique development tool enabling the development of any supervision application, from small stand-alone systems to large distributed redundant systems.

Application designers and users benefit from the competence of Schneider Electric for its mastery of system integration. Moreover, the offer is continuously updated to make the latest technologies available to the customers.

Redundancy

Vijeo Citect offers total redundancy. The redundancy functions are fully integrated within the system and intuitive to configure.

Server license

Vijeo Citect exists in a:

- Client-Server** architecture and ranges from 75 Points to an unlimited number of Points
- Stand-alone** version called **Vijeo Citect Lite** that can manage 300, 600 or 1200 Points. See page 4/55.

Vijeo Citect automatically installs OFS, the OPC server of Schneider Electric. This does not require registration. This component can only be used with Vijeo Citect software.

OFS software provides access to any of the PLC variables: Elementary Data type, Derived Data type and Function Blocks. Furthermore OFS periodically checks the consistency between the PLC applications and the SCADA one. This is one of major benefits provided by Schneider Electric integration.

Server licenses **VJC 1011 ●●** are purchased by number of Points that are required for processing, not I/O (1). An upgrade offer to the **VJC 1011 1●●●** is available for increasing the number of Client and Server Points, if required at a later date (2).

(1) Vijeo Citect counts the variables exchanged with external devices, such as PLCs.

(2) If the Server or Client is upgraded, the keys must be reprogrammed

Client license

Client licenses are generally purchased using the same Points Count as the Server to which they are connected. Four types of Clients are available:

- **Display Client, VJC 1020 ●●**: used by operators accessing the Vijeo® Citect® Server through a local connection,
- **Manager Client, VJC 1030 ●●**: for users needing to view the Vijeo Citect application via a local connection, but not needing to control the system,
- **Web Display Client, VJC 1022 ●●**: similar to Display Client but through a Web connection,
- **Web Manager Client, VJC 1032 ●●**: similar to Manager Client but via the Web.

Static, Floating and Redundancy Client license

According to requirements, a Client license can either be Static, Floating or Redundant:

- **Static Client license**: For operators that must have immediate access to the system, regardless of the number of connections already established by other Clients.
A Static Client license provides permanent access to the control system—since the system physically resides in the key plugged into the Client PC.
- **Floating Client license**: Users who need to occasionally use a Client for operator tasks can purchase Floating licenses. Connections will be allowed provided that the number of valid licenses is not exceeded. Floating Client licenses are stored on the key plugged into the Server.
- **Redundant Client license**: Redundant Client licenses **VJC 10●● 88** are solely intended for the Standby Server in a Redundant configuration. They are used to verify that the number of Client licenses purchased are available.

Development workshop

Development workshop **VJC 1099 ●2** comprises the physical items such as the CD-ROM, hardware keys, installation guide and storage boxes.

Setup:

- Each Server requires a hardware key (USB or parallel) to operate.
- The Server key is used to store the Floating Client licenses.
- The key controls the number of Points that can be used.
- The key is programmed to operate up to the predetermined version.

Promotional and Evaluation License

A development workshop Promotional License **VJC 1095 ●●** is available. It is only available for teaching purposes and meets the requirements for demonstrations and testing.

With an Evaluation License it is possible to develop an application and test it for 10 minutes in stand-alone mode.

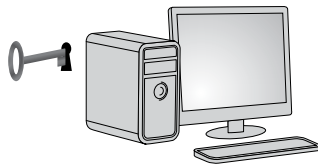

Single station architecture

Architectures

SCADA system stand-alone single station, 5000 Points

Development workshop

- 1 x **VJC 1099 22**, physical delivery of the CD with USB key.

Server license

- 1 x **VJC 1011 14**, Server license for 5000 Points (includes Server Client).

Client license

- Not required. Included in the Server license.

4



Single server architecture with Web Manager Client access

Remote server system with remote access via the web

Development workshop

- 1 x **VJC 1099 22**, physical delivery of the CD with USB key.

Server license

- 1 x **VJC 1011 15**, server license for 15000 Points (includes Server Client).

Client license

- 1 x **VJC 1032 15**, Web Manager client license for 15000 Points.

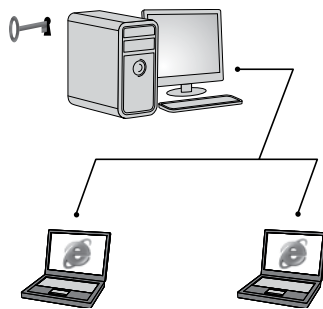

Single server architecture with 1 Web Display Client and 1 Web Manager Client

Networked server system with remote web clients

Example: Networked Server system, 500 Points, with 2 remote Clients via the Web: one Web Display and one Web Manager.

Development workshop

- 1 x **VJC 1099 22**, physical delivery of the CD with USB key.

Server license

- 1 x **VJC 1011 12**, server license for 500 Points (includes Server Client).

Client licenses

- 1 x **VJC 1022 12**, Web Display client license for 500 Points.
- 1 x **VJC 1032 12**, Web Manager client license for 500 Points.

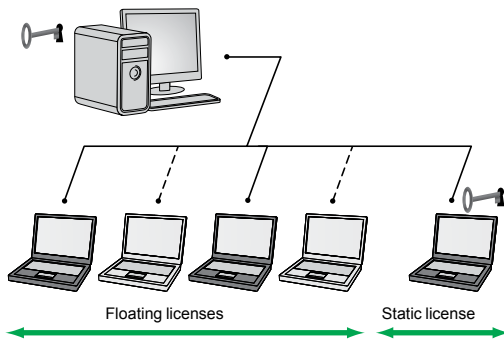

Single server architecture with 2 Floating Display Client licenses and 1 Static license

Architectures (continued)

Networked server system with floating and static access

Example: Networked Server system, 5000 Points, with 5 Client PCs and 3 Client licenses, including 2 Floating licenses and 1 Static license.

Development workshop

- 1 x **VJC 1099 22**, physical delivery of the CD with USB key.
- 1 x **VJC 1099 21**, additional USB key for Static Client.

Server license

- 1 x **VJC 1011 14**, Server license for 5000 Points, includes Client Server (local Display Client type on the Server PC).

Client licenses

- 3 x **VJC 1020 14**, Display Client licenses for 5000 Points.

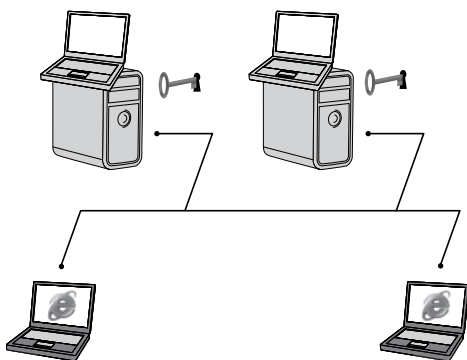

Redundant architecture with 2 Display Clients on servers and 2 Web Manager Clients

Redundant server with Server Display Clients and Web Manager Clients

Example: Redundant server, 1500 Points, with 2 Display Clients on the Servers and 2 Web Manager Clients.

Development workshop

- 1 x **VJC 1099 22**, physical delivery of the CD with USB key: Primary server key.
- 1 x **VJC 1099 21**, additional USB key for Standby Server (rule: 1 key per Server).

Server licenses

- 2 x **VJC 1011 13**, Server licenses for 1500 Points (includes Server Client).
 - The first Server acts as the Primary Server,
 - The second Server acts as the Standby Server,
 - The license will be placed on each key (Primary and Standby).

Client licenses

- 2 x **VJC 1032 13**, Web Manager Client licenses for 1500 Points.
 - These 2 licenses will be placed on the Primary Server key.

Redundant Client license:

- 2 x **VJC 1032 88**, Redundant Web Manager Client licenses
 - Floating Redundant licenses for Web Manager Client licenses,
 - These 2 licenses will be placed on the Standby Server key.

Modicon® M340™ automation platform

Vijeo® Citect® supervisory software



VJC 1099 22/12



VJC 1099 21

VJC 1099 11



Development workshop - Vijeo® Citect® Box and key(s)

Vijeo Citect Box VJC 1099 ●2 includes:

- 1 CD-Rom with Vijeo Citect software
- Schneider Electric drivers pack
- an installation guide
- a hardware key

Additional keys are also delivered in the Vijeo Citect Box.

Development workshop - Vijeo® Citect® Box

Description	Type of key included	Reference	Weight kg
Vijeo® Citect® Box USB key	USB	VJC 1099 22	0.410
Vijeo Citect Box Parallel key	Parallel	VJC 1099 12	0.420

Additional Vijeo Citect keys

Description	Target license	Reference	Weight kg
Additional Vijeo Citect USB key Delivered in Vijeo Citect Box	Redundant Server and Static (non-floating) licenses.	VJC 1099 21	-
Additional Vijeo Citect parallel key Delivered in Vijeo Citect Box	Redundant Server, Static (non-floating) and demonstration licenses.	VJC 1099 11	-

Vijeo® Citect® Lite, stand-alone

The Vijeo® Citect® Lite stand-alone license, for 300, 600 or 1200 Points, includes:

- 1 CD-Rom with Vijeo Citect software
- Schneider Electric drivers pack
- an installation guide
- a hardware key

A simple solution for stand-alone applications, a Vijeo Citect Lite license is used for connecting a single client to a single sector. It cannot be made redundant.

A Vijeo Citect Lite license can be upgraded to a full Vijeo Citect license (1).

Vijeo Citect Lite license

Description	Number of Points	Reference	Weight kg
Vijeo Citect Lite	300	VJC 3011 27	-
Stand-alone: no connectivity	600	VJC 3011 59	-
Key to be ordered separately	1200	VJC 3011 50	-

Vijeo Citect Lite upgrades

The references indicated below are for upgrading the number of Vijeo Citect Lite Points:

- Regarding the number of Points in the Lite version,
- From Vijeo Citect Lite to the full Vijeo Citect Server version (see below).

Description	Number of Points	Reference	Weight kg
Vijeo Citect Lite number of Points upgrade	300 to 600	VJC L27 F59	-
	600 (2) to 1200	VJC L59 L50	-
Vijeo Citect Lite to Vijeo Citect Server upgrade	300 Lite to 600 Server	VJC L27 F12	-
	600 Lite (2) to 1500 Server	VJC L59 F13	-
	1200 Lite to 1500 Server	VJC L50 F13	-

(1) Requires reprogramming of key VJC 1094 00.

(2) Also for existing Lite 500 Point versions installed.

Modicon® M340™ automation platform

Vijeo® Citect® supervisory software



Vijeo® Citect® Server

Vijeo® Citect® Server licenses (complete system), graded by the number of points Points, include:

- 1 CD-Rom with Vijeo Citect including OFS and SpeedLink
- Schneider Electric drivers pack
- an installation guide
- a hardware key

Redundant system

For a redundant system order 2 Server licenses.

No other option is required regarding the Servers.

The programmed key (USB or parallel) must be ordered separately.

Vijeo® Citect® Server license

Description	Number of Points	Reference	Weight kg
Vijeo® Citect® Server	75	VJC 1011 10	–
Full version.	150	VJC 1011 11	–
Key to be ordered separately.	500	VJC 1011 12	–
	1500	VJC 1011 13	–
	5000	VJC 1011 14	–
	15000	VJC 1011 15	–
	Unlimited	VJC 1011 99	–

Vijeo Citect Server upgrade

The references indicated below are for upgrading the number of Points on the Server.

Description	Number of Points	Reference	Weight kg
Vijeo Citect Server upgrade	75 to 150	VJC 1011 10 11	–
	150 to 500	VJC 1011 11 12	–
	500 to 1500	VJC 1011 12 13	–
	1500 to 5000	VJC 1011 13 14	–
	5000 to 15000	VJC 1011 14 15	–
	15000 to Unlimited	VJC 1011 15 99	–

Modicon® M340™ automation platform

Vijeo® Citect® supervisory software

Vijeo® Citect® Display Client

Vijeo® Citect® Display Client licenses are intended for operators. Licenses for these Clients are graded according to the number of Points to be displayed. They can use either a:

- Floating license, residing on the Server key
- Static license: requiring a separate key on the Client PC

Redundant system

- The number of Floating Clients ordered is added to the Primary Server key,
- For the Standby Server, the same number of Redundant Display Client licenses **VJC 1020 88** must be ordered.

Vijeo® Citect® Display Client license

Description	Number of Points	Reference	Weight kg
Vijeo® Citect® Display Client license	75	VJC 1020 10	–
	150	VJC 1020 11	–
	500	VJC 1020 12	–
	1500	VJC 1020 13	–
	5000	VJC 1020 14	–
	15000	VJC 1020 15	–
	Unlimited	VJC 1020 99	–

Description	Details	Reference	Weight kg
Vijeo Citect Redundant Display Client license	Floating license only	VJC 1020 88	–

Vijeo® Citect® Manager Client

Vijeo® Citect® Manager Client licenses are available for users who need to view the application without controlling it. Licenses for these Clients are graded according to the number of Points to be displayed. They can use either a:

- Floating license, residing on the Server key
- Static license, the hardware key being plugged into the Client station

Redundant system

- The number of Floating Clients ordered is added to the Primary Server key,
- For the Standby Server, the same number of Redundant Manager Client licenses **VJC 1030 88** must be ordered.

Vijeo Citect Manager Client license

Description	Number of Points	Reference	Weight kg
Vijeo Citect Manager Client license	75	VJC 1030 10	–
	150...unlimited	VJC 1030 99	–

Description	Details	Reference	Weight kg
Vijeo Citect Redundant Manager Client license	Floating license only	VJC 1030 88	–

Modicon® M340™ automation platform

Vijeo® Citect® supervisory software



Vijeo® Citect® Web Display Client

Vijeo® Citect® Web Display Client licenses are intended for users who need full control of the application but prefer the flexibility of access via a Web connection. These Client licenses are graded according to the number of Points displayed and must be of the floating type (residing on the key plugged into the Server).

Redundant system

- The number of floating Clients ordered is added to the Primary Server key
- For the Standby Server, the same number of Redundant Web Display Client licenses **VJC 1030 88** must be ordered

Vijeo® Citect® Web Display Client license

Description	Number of Points	Reference	Weight kg
Vijeo® Citect®	75	VJC 1022 10	–
Web Display Client license	150	VJC 1022 11	–
	500	VJC 1022 12	–
	1500	VJC 1022 13	–
	5000	VJC 1022 14	–
	15000	VJC 1022 15	–
	Unlimited	VJC 1022 99	–

Description	Details	Reference	Weight kg
Vijeo Citect Redundant Web Display Client license	Floating license only	VJC 1022 88	–

Vijeo® Citect® Web Manager Client

Vijeo® Citect® Web Manager Client licenses are intended for users who need to view the application via a Web connection, but do not need to control the system. These Client licenses are graded according to the number of Points displayed and must be of the floating type (residing on the key plugged into the Server).

Redundant system

- The number of Floating Clients ordered is added to the Primary Server key,
- For the associated Standby server, the same number of Manager Client Redundant licenses **VJC 1032 88** must be ordered.

Vijeo Citect Web Manager Client license

Description	Number of Points	Reference	Weight kg
Vijeo Citect	75	VJC 1032 10	–
Web Manager Client license	150...unlimited	VJC 1032 99	–

Description	Details	Reference	Weight kg
Vijeo Citect Redundant Web Manager Client license	Floating license only	VJC 1032 88	–

Modicon® M340™ automation platform

Vijeo® Citect® supervisory software

Display Client upgrade

The references indicated below are for upgrading the number of Points on the:

- Server where the hardware key is plugged, for floating licenses
- Client where the hardware key is plugged, for static licenses

Vijeo® Citect® Display Client upgrade (1)

Description	Number of Points	Reference	Weight kg
Vijeo® Citect® Display Client upgrade	75 to 150	VJC 1020 10 11	–
	150 to 500	VJC 1020 11 12	–
	500 to 1500	VJC 1020 12 13	–
	1500 to 5000	VJC 1020 13 14	–
	5000 to 15000	VJC 1020 14 15	–
	15000 to Unlimited	VJC 1020 15 99	–

Manager Client upgrade

The references indicated below are for upgrading the number of Points on the:

- Server where the hardware key is plugged, for floating licenses
- Client where the hardware key is plugged, for static licenses

Vijeo Citect Manager Client upgrade (1)

Description	Number of Points	Reference	Weight kg
Citect Manager Client upgrade	75 to 150	VJC 1030 10 11	–
	150 to 500	VJC 1030 11 12	–
	500 to 1500	VJC 1030 12 13	–
	1500 to 5000	VJC 1030 13 14	–
	5000 to 15000	VJC 1030 14 15	–
	15000 to Unlimited	VJC 1030 15 99	–

Web Display Client upgrade

The references indicated below are for upgrading the number of Points on the Server where the hardware key is plugged.

Vijeo Citect Web Display Client upgrade (1)

Description	Number of Points	Reference	Weight kg
Vijeo Citect Web Display Client upgrade	75 to 150	VJC 1022 10 11	–
	150 to 500	VJC 1022 11 12	–
	500 to 1500	VJC 1022 12 13	–
	1500 to 5000	VJC 1022 13 14	–
	5000 to 15000	VJC 1022 14 15	–
	15000 to Unlimited	VJC 1022 15 99	–

Web Manager Client upgrade

The references indicated below are for upgrading the number of Points on the Server where the hardware key is plugged.

Vijeo Citect Web Manager Client upgrade (1)

Description	Number of Points	Reference	Weight kg
Vijeo Citect Web Manager Client upgrade	75 to 150	VJC 1032 10 11	–
	150 to 500	VJC 1032 11 12	–
	500 to 1500	VJC 1032 12 13	–
	1500 to 5000	VJC 1032 13 14	–
	5000 to 15000	VJC 1032 14 15	–
	15000 to Unlimited	VJC 1032 15 99	–

(1) The reprogramming fee, VJC 1094 00, is applicable for any key upgrade.

Modicon® M340™ automation platform

Vijeo® Citect® supervisory software

Vijeo® Citect® - Specific drivers

The Vijeo® Citect® offer includes an extensive number of drivers as standard. However, for copyright reasons, some drivers have a specific reference and they must be ordered separately. Purchasing a specific driver includes access to the appropriate technical support for the driver for one year.

Description	Protocol	Reference	Weight kg
Vijeo® Citect® specific driver	IEC 60870-5-104	VJC 3051 41	–
	PSDirect ETH	VJC 3051 40	–
	PSDirect MPI	VJC 3051 42	–
	Bailey	VJC 3051 44	–
	SEMAPI	VJC 3051 48	–
	MOSCAD	VJC 3051 49	–

Note: Before ordering a Vijeo Citect specific driver, please consult your Schneider Electric Regional Sales Office.

Vijeo® Citect® - Key reprogramming

Any reprogramming of the Vijeo Citect key is subject to order reference **VJC 1094 00**:

- upgrading the number of Points
- adding Clients
- upgrading a Vijeo Citect Lite license to a full Vijeo Citect license
- exchanging a parallel key for a USB key

Note: If a new key is required, an additional Vijeo Citect key must be purchased. See page 4/54.

Description	Reference	Weight kg
Vijeo Citect Key reprogramming	VJC 1094 00	–

Vijeo® Citect® Support

From the second year of ownership of one or more Vijeo Citect licenses, Vijeo Citect Support enables the user to continue receiving the benefits of full support for the installed base. One of the services included in this offer is to receive the latest version updates.

Description	Details	Reference	Weight kg
Support	For Vijeo Citect software and licenses	VJC 1091 01	–
	For Vijeo Citect specific drivers	VJC 1091 01D3	–

Third-party applications converter

Switch 2 Vijeo Citect is a conversion tool that helps to convert legacy SCADA to Vijeo Citect. It allows the tag database and graphic information to be reproduced inside Vijeo Citect. The conversion rate depends upon the complexity of the application and can vary from 15% to 80%.

Description	Details	Reference	Weight kg
Switch 2 Vijeo Citect	Third-party applications converter	VJC 1090 88	–

Vijeo® Citect® Loan key

Description	Details	Reference	Weight kg
Vijeo Citect Loan key USB key only (1)	Provides temporary access to a key (2). 8 days continuous usage. The hardware key must be returned at the end of the loan period.	VJC 1095 03	–

(1) Also requires an additional USB key, **VJC 1099 21**.

(2) The quantity ordered equals the number of months of the required loan period.

Modicon® M340™ automation platform

OPC® data server software

OPC Factory Server (OFS)

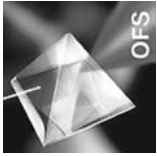

Web-enabled Power & Control
Transparent
Ready®

Introduction

Based on the OLE for Process Control (OPC®) standard, Schneider Electric's OPC Factory Server (OFS) software allows "client" software applications, such as supervisors/SCADA and customized interfaces, to access the data of Schneider Electric automation system and electrical distribution devices connected to networks or fieldbus in real-time.

It also allows communication with third party devices supporting Modbus® and Modbus/TCP protocols.

At the heart of the Transparent Ready® offer, OFS enables simpler, more open and transparent communication between your software applications and your devices. These are just some of the advantages that help ensure a complete interoperability solution that is central to your process.

In version V3.3, the OFS data server integrates the most recent specifications of the OPC Foundation:

- **OPC-DA** (OPC Data Access)
- **.NET API interface**
- **OPC XML-DA V1.0** (OPC XML Data Access)

The OFS V3.3 offer is available in two levels:

- **OFS Small:** data server for 1000 items (1) that does not support the OPC XML-DA protocol
- **OFS Large:** complete server data

Devices and protocols supported

OFS software is a multi-device data server. It allows simultaneous use of several communication protocols, and it provides client applications with a set of services for accessing automation system items that may be local or remote, via physical address or via symbol.

Devices supported:

- Modicon® Quantum™, Premium™, TSX Micro™, Compact™ and Momentum™ PLCs
- TSX Series 7 and April Series 1000 Schneider Electric PLCs
- Serial Modbus® devices connected via Schneider Electric gateways: TSX ETG 10●●, EGX ●●● ranges, etc.
- Serial Uni-Telway™ devices connected via Schneider Electric gateways (TSX ETG 1010)

Networks and protocols supported:

- Modbus®: Modbus® serial, Modbus Plus™, Modbus®/TCP.
- X-Way™, UNI-TE™, Uni-telway™, Fipway®, Ethway™, ISAWay™, PCIway™.

Openness

The development of specialized interfaces is simpler with OFS V3.3 software that is designed in particular for two types of users:

■ **End users** who either want to interface their supervision or human/machine interface applications with Schneider Electric equipment or to develop applications on a PC (supervisory control screens, Excel tables, etc.) requiring access to automation system data.

■ **Suppliers of automation system or industrial data processing software** (supervision, human/machine interfaces, etc.) seeking to develop, within their standard products, an OPC Client interface capable of accessing data in Schneider Electric equipment via the OFS server.

(1) Items include variables, structures, tables, etc. of the Unity™ Pro application.

Modicon® M340™ automation platform

OPC® data server software

OPC Factory Server (OFS)



OPC Factory Server home page

Architectures supported

The OFS server allows four access modes:

- a purely local mode
- remote access from an OPC-DA client
- remote access from an OPC .NET client
- remote access from an OPC XML-DA client

Local access

The client application and the OFS server are on the same PC.

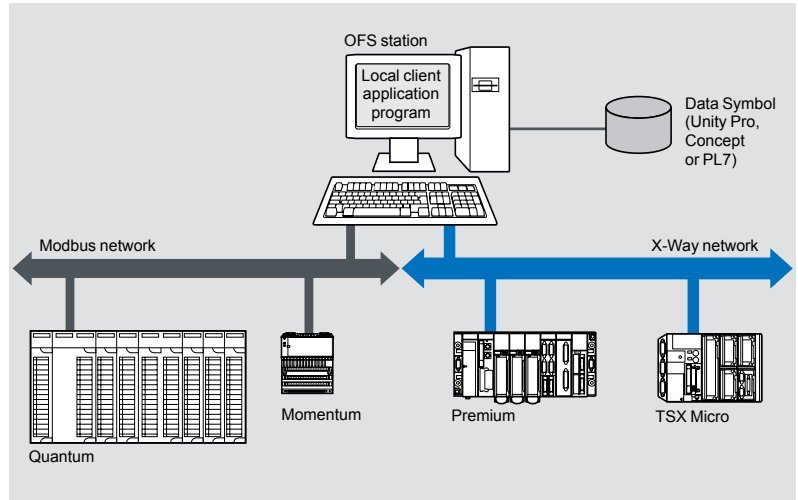

4

Remote access from an OPC-DA client

The client application and the OFS data server are on remote stations.

Communication between the client station and the OFS server is conducted through the DCOM layer (Microsoft®) via the OPC-DA protocol.

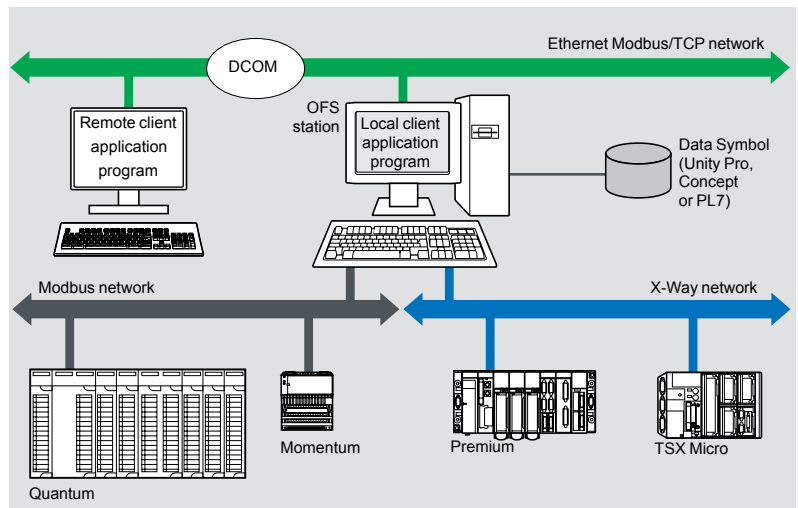

Modicon® M340™ automation platform

OPC® data server software

OPC Factory Server (OFS)

Supported architectures (continued)

Remote access from an OPC .NET client

The .NET client application program and the OFS data server are on remote stations. Communication between the client station and the OFS server is conducted through the DCOM layer (Microsoft®) via the OPC-DA protocol.

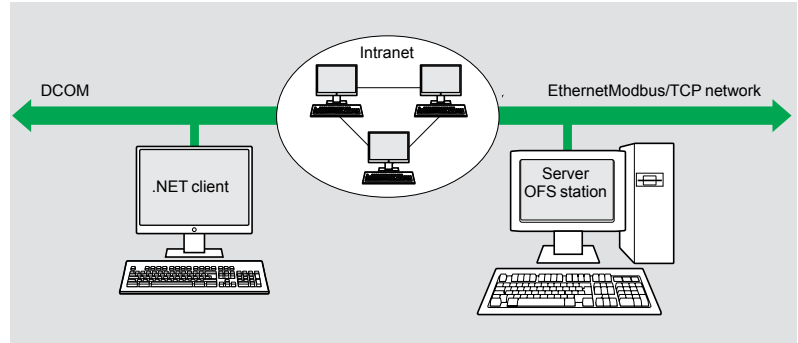

The .NET Microsoft compatibility of the OFS server has been developed to allow an OPC .NET client to access OFS server items on an Intranet network via the OPC .NET API interface.

This interface helps to ensure interoperability between existing OPC applications and applications developed in the native .NET environment

Remote access from an OPC XML-DA client via HTTP

The client application program and the OFS server are on remote stations, using the SOAP protocol to communicate via the Internet in conformity with the OPC XML-DA V1.01 specification of the OPC Foundation. The OFS data server is based on an HTTP server installed on the same station.

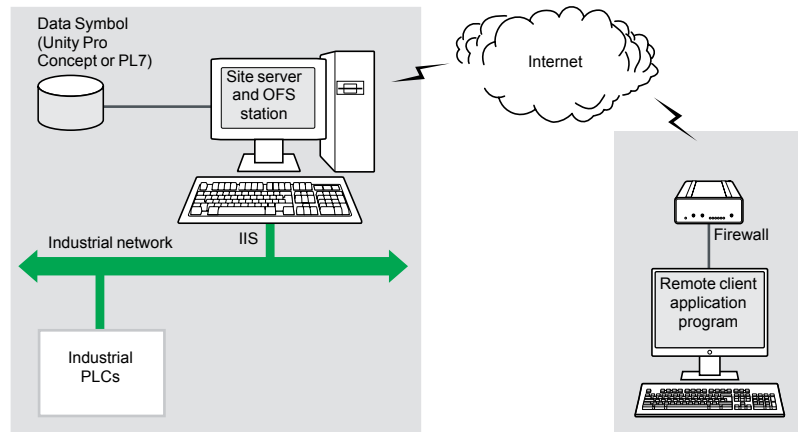

The OPC XML-DA V1.0 specifications are designed to overcome the limitations of COM/DCOM by providing:

- An OPC interface for Windows® and non-Windows client applications
- Beyond the Intranet perimeter, remote access via the Internet through firewalls

The OPC XML-DA specification is based on “Web Services” standards such as SOAP, XML, WSDL (1). A SOAP client can access data on the OFS server via Intranet or Internet using the SOAP protocol in conformity with the OPC XML DA V1.01 specification of the OPC foundation.

(1) SOAP: Simple Object Access Protocol
XML: Extended Markup Language
WSDL: Web Services Description Language

Modicon® M340™ automation platform

OPC® data server software OPC Factory Server (OFS)

Setup

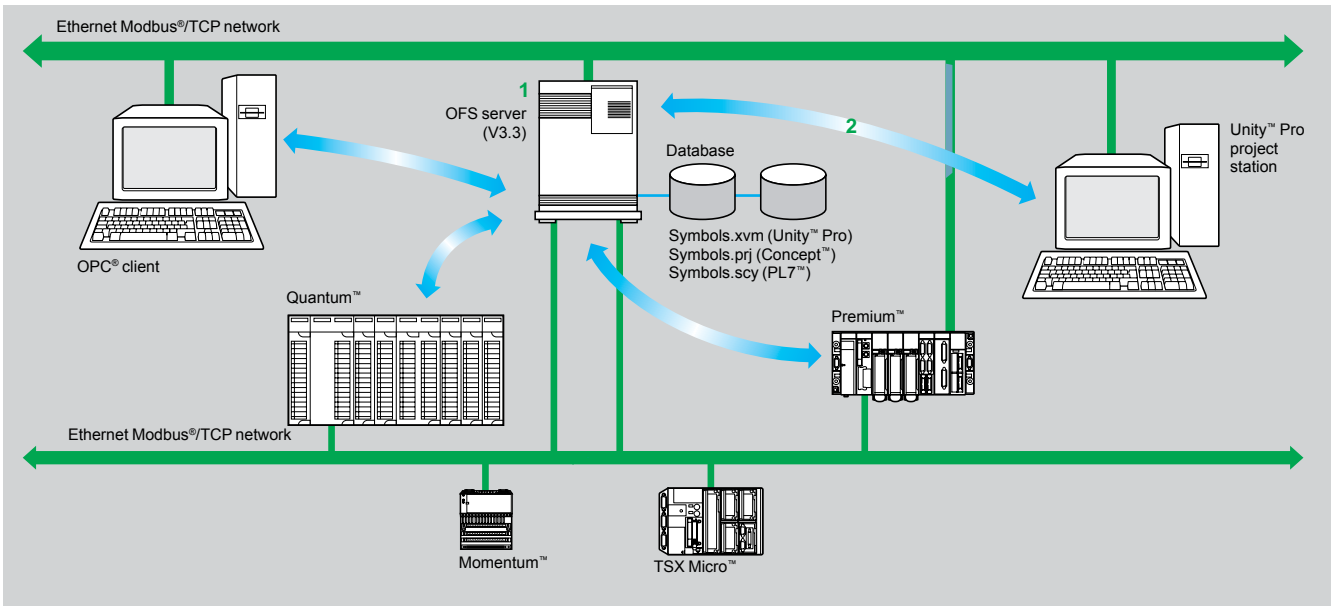

The OFS server **1** is the center of the data exchanges. The direct and dynamic link **2** between the OFS server and the Unity™ Pro project station results in productivity gains for designers and users of the devices. Effectively, OFS has direct access to the items in the Unity Pro project. In addition, it performs a consistency check between these items and those of the Premium™ and Quantum™ PLCs.

Note: Depending on the software used for configuring Modicon® PLCs:

- PL7™ software generates PLC variable symbol export files. These export files (symbols.scy) must be integrated in the OPC server.
- Concept™: the variables can be accessed directly in the project (file.prj) of the Concept application. This direct link requires Concept (version > 2.0) to be installed on the OFS station **1**
- If the Unity™ Pro project development station is not accessible via the OFS station, the PLC variable symbol export files (symbols.xvm) generated by Unity Pro must be integrated in the OPC server.

Functions

Development of client applications

OFS software has 4 types of interface:

■ **OLE Automation interface (OPC-DA)**

Particularly suitable for end users, it enables the development of OPC® client applications in Microsoft® Visual Basic®, in Visual Basic for Excel, and in C++.

■ **OLE Custom interface (OPC-DA)**

Used primarily by suppliers of automation system or industrial IT products, it enables the development of applications in C++ to access the OFS software OPC server. This interface is particularly aimed at software development experts, so that they can integrate the client application in their standard products. This is the interface with the highest performance, in terms of access time to data stored in the OPC server. It requires extensive knowledge of C++ programming to setup.

■ **OPC .NET API wrapper interface**

The .NET Microsoft® compatibility of the OFS data server gives an OPC .NET client native access to items of the OFS server via an Intranet network, thus helping to ensure greater interoperability with native .NET environments.

Note: In this case, communication between the OPC .NET client and the OFS server is conducted through the DCOM layer (or COM layer in a local configuration) via the OPC-DA protocol.

■ **OPC XML-DA interface (1)**

The OPC XML-DA V1.0 specifications are designed to overcome the limitations of the OPC-DA specification and COM/DCOM by providing:

- An interface for Microsoft® Windows® and non-Windows client applications
- Remote access via the Internet through firewalls (beyond the Intranet perimeter)

The OPC XML-DA specification is based on Web Services standards such as SOAP, XML, WSDL. A SOAP client can access data on the OFS server via Intranet or Internet using the SOAP protocol in conformity with the OPC XML-DA V1.01 specification of the OPC Foundation.

(1) Only available with the Large version of OPC Factory Server V3.3

Modicon® M340™ automation platform

OPC® data server software

OPC Factory Server (OFS)

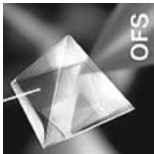

References

OFS V3.3 software for PC compatible stations (minimum configuration: Pentium 566 MHz processor, 128 MB RAM) running Windows 2000® Professional (1) or Windows XP® Professional.

The OFS V3.3 offer is comprised of:

- OPC server software
- OPC server simulator (for debugging the application when no PLC is present)
- OFS server configuration software
- An example of OPC client for configuring applications
- The setup documentation on CD-ROM

Supplied on CD-ROM, the software operates independently on a PC. It interfaces with the variables export files generated by PL7™, ProWORX™, Concept™ and Unity™ Pro software. It also provides a direct and dynamic link to the Unity Pro and Concept applications (2).

OFS V3.3 software is available in two versions:

■ **Small version TLX CD S●OFS 33**

- Maximum of 1000 items
- Protocols are supported with the exception of OPC XML-DA
- Single station and 10-station site licenses

■ **Large version TLX CD L●OFS 33**

- Full version
- Single station, 10-station and 200-station site licenses

OPC® Factory Server V3.3 Small

Description	Type of license	Reference	Weight kg
OPC® Factory Server V3.3 Small software	Single station	TLX CD SUOFS 33	–
	10 stations	TLX CD STOFS 33	–

OPC Factory Server V3.3 Large

Description	Type of license	Reference	Weight kg
OPC Factory Server V3.3 Large Full version	Single station	TLX CD LUOFS 33	–
	10 stations	TLX CD LTOFS 33	–
	200 stations	TLX CD LFOFS 33	–

(1) Must be updated with Service Pack 1 or higher.

(2) Requires Concept version > 2.0 software to be installed on the same station.

Connection interfaces, regulated switch power supplies and Human/Machine Interfaces

5.1 - Modicon® Telefast® ABE 7 pre-wired system

Modicon Telefast ABE 7 selection guide	5/2
■ Introduction, combinations	5/6
■ References	
□ Passive connection sub-bases	5/8
□ Adaptation sub-bases with soldered relays and removable terminal blocks	5/9
□ Adaptation sub-bases for plug-in relays	5/10
□ Connection sub-bases for analog channels	5/11
□ Plug-in relays	5/12
□ Accessories for connection sub-bases	5/13
■ Dimensions	5/14

5.2 - Power supplies for DC control circuits

Phaseo® power supplies selection guide	5/16
■ Universal range of regulated switch mode power supplies	
□ Introduction, description	5/18
□ Specifications	5/20
□ References	5/25
□ Dimensions	5/26
□ Connections	5/27

5.3 - Human/Machine Interfaces

Selection guides

□ Magelis® Small Panels	5/30
□ Magelis Advanced Panels	5/30
□ Vijeo® Designer™ HMI software	5/30



Modicon® M340™ automation platform

Connection interfaces

Modicon® Telefast® ABE 7 pre-wired system

Sub-bases for Modicon M340 I/O modules

Applications	Discrete inputs or outputs		
	Optimum "Low cost"	Optimum "Miniature"	Universal



Sub-base type	Passive connection sub-bases			
Equipped with relay	-			
Control voltage	~ 24V			
Output voltage	~ 24V			
Output current per channel	0,5 A			
Modularity	16	8 -16		
No. of terminals per channel	1	1 to 3	1	2
Type of connection terminals	Signal	Signal, common (configurable ~ 24 V or 0 V)	Signal	Signal, common (configurable ~ 24V or 0 V)
Connector	20-way HE 10 connector			
Terminal block	Removable	No	No	
	Terminal type	Screw	Screw or spring	
Additional function ★	Low cost version fitted with cordset	Miniature sub-bases	Compact size ★	Type 2 input ★ Isolator ★
Device type	ABE 7H34E●00	ABE 7H16C●●	ABE 7H●●R1● ABE 7H●●R50	ABE 7H●●R21● ABE 7H●●S21
Pages	5/8			

Discrete inputs or outputs (continued)	Discrete inputs	Discrete outputs
Universal		Miniature



–		Solid state, fixed	Solid state, plug-in	Plug-in electromechanical or solid state	
–		Yes	No	No	Yes
~ 24 V		From ~ 24 V to ~ 230 V	From ~ 5 V TTL to ~ 230 V	~ 24V	
~ 24 V (solid state) ~ 5... 24V, ~ 230 V (electromechanical)					
0,5 A	125 mA	12 mA		5 A (E.M.), 2 A (solid state)	5 A (I th)
16			16 8 passive inputs 8 relay outputs		
3	2		1		
Signal ~ 24 V and 0 V	Signal can be isolated, Protected common	Signal	Signal and common	1 N/O contact and common, 4 output channels 2 input connection points	
20-way HE 10 connectors					
No		Yes	No		
Screw		Screw or spring		Screw	
3-wire proximity sensor	Isolator and fuse (indicator)	–		Common per 4 channels	
ABE 7H16R3●	ABE 7H16S43	ABE 7S16E2●●	ABE 7P16F31	ABE 7P16M111	ABE 7R16M111
5/8	5/9	5/10	5/11	5/10	

5

Modicon® M340™ automation platform

Connection interfaces

Modicon® Telefast® ABE 7 pre-wired system

Sub-bases for Modicon M340 I/O modules

Applications	Discrete outputs (continued)			
	Optimum	Universal	Optimum	Universal



Sub-base type	Electromechanical, fixed		Electromechanical or solid state		
Equipped with relay	Yes		Yes	No, to be ordered separately	
Control voltage	≍ 24 V				
Output voltage	≍ 5 V... 30 V ~ 230 V		≍ 5 V... 150 V ~ 230 V	≍ 24 V (solid state) ≍ 5 V... 24 V, ~ 230 V (E.M.)	≍ 5 V... 150 V ~ 230 V
Output current per channel	2 A (l th)	3 A (l th)	5 A (l th)	2 A (solid state), 6 A (electromechanical)	Depends on relay mounted 0,5 to 10 A
Modularity	8	8 - 16		16	8 or 16
No. of terminals per channel	2	1	2	1	2 to 3
Type of connection terminals	1 N/O contact and common Free-voltage	1 N/O contact	1 N/O contact and common	1 N/O contact	Signal, Polarities
Connector	20-way HE 10 connector				
Terminal block	Removable Terminal type	Yes	Yes	Yes	No
		Screw or spring		Screw	Screw or spring
Additional function	Miniature sub-base Latching relay	Volt-free or common per 8 channels		Miniature sub-bases Common per 4 channels	Isolator and fuse
Device type	ABE 7R08S216●	ABE 7R●●S1●●	ABE 7R●●S2●●	ABE 7R16T111	ABE 7P16T111
					ABE 7P16T2●●● ABE 7P08T3●●●
Pages	5/9		5/10	5/11	

5

Discrete outputs (continued)	Analog inputs/outputs		
Universal	Input modules BMX ART 0414/0814	BMX AMI 0410	Output module BMX AMO 0210



Electromecanical , plug-in		Solid state, fixed		Passive		–							
Yes		Yes		–		–							
≡ 24 V				≡ 24 V		–							
≡ 5 V... 150 V ~ 230 V		≡ 24 V		–		–							
5A (I th)	8 A (I th)	from 0,5 to 2 A	125 mA	–									
16				4		2 (+ 2 not used)							
2 to 3	2 to 6	2		3									
1 C/O contact or 1 N/O contact and common		1 C/O contact or 2 N/O contact and common		Signal and 0 V									
20-way HE 10 connector				25-way SUB-D connector									
No		Yes		No		No							
Screw		Screw or spring		Screw		Screw							
Volt-free or common per:		Detected fault signal		Isolator and fuse (indicator)		Direct connection of 4 thermocouples Connection and provision of cold-junction compensation		Direct connection of 4 channels Delivered and distributes 4 protected isolated power supplies		Direct connection of 2 channels			
8 channels		4 channels											
ABE 7R16T2●●		ABE 7R16T3●●		ABE 7S●●S2B●		ABE 7H16F43		ABE 7CPA412		ABE 7CPA410		ABE 7CPA21	
5/10		5/9		5/8		2/31 and 5/11							

Modicon® M340™ automation platform

Connection interfaces

Modicon® Telefast® ABE 7 pre-wired system Sub-bases for Modicon M340 I/O modules

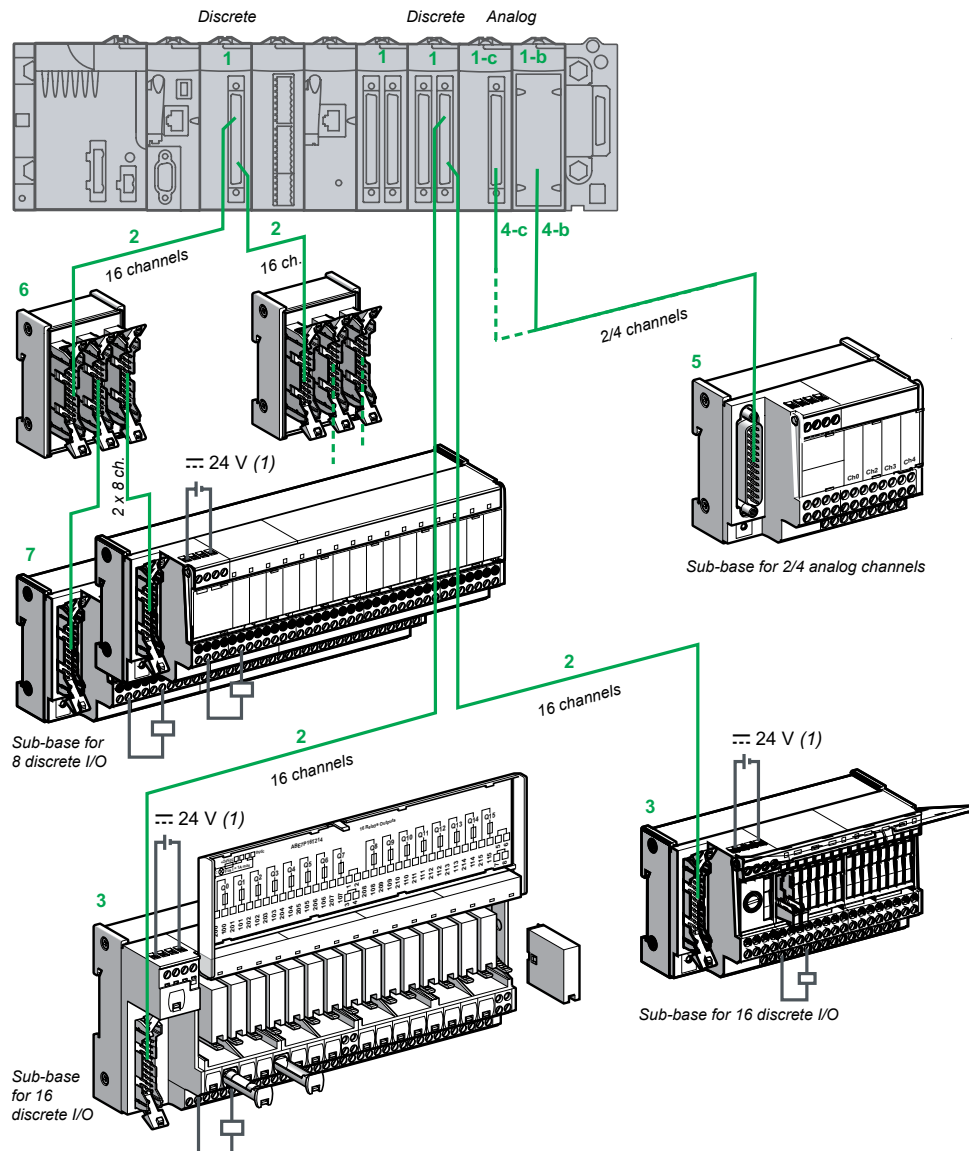

- 1 Discrete **BMX DDI ●●02K** input modules, **BMX DDO ●●02K** output modules and **BMX DDM 3202K** mixed I/O modules equipped with one or two 40-way connectors. The module modularity (●●) is 32 or 64 channels.
- 1 Analog **BMX AMI 0410 1-b** (4 channels), **BMX ART 0414 1-c** (4 channels), **BMX ART 0814 1-c** (4 channels) inputs modules and **BMX AMO 0210 1-b** (2 channels) output module
- 2 Cordset equipped with connectors (one 40-way connector with one or two 20-way HE 10s). 2 models are available: cordsets with one or two 20-wire sheaths (AWG 22) equipped with an HE 10 moulded connector, **BMX FCC ●●1/●●3**. These cordsets are available in 0.5, 1, 2, 3, 5 or 10 m lengths.
- 3 16-channel Optimum™ or Universal Modicon® Telefast® ABE 7 passive connection sub-bases or adaptor sub-bases.
- 4 Cordset equipped with connectors (including one 25-way SUB-D type on the sub-base end). 2 models are available, depending on the type of connections on the analog module side:
 - **4-c** 40-way connector, **BMX FCA●●2** cordset for **ABE 7CPA412** analog input module
 - **4-b** 20-way screw terminal block, **BMX FCA●●0** cordset for **ABE 7CPA410/CPA21** sub-bases
 These cordsets are available in 1.5, 3 or 5 m lengths.
- 5 Sub-bases for analog input/output modules:
 - **ABE 7CPA410** for connection on a screw terminal block of 4 current/voltage inputs of the **BMX AMI 0410** analog module, with supply of 4 isolated protected power supplies for the current loop inputs.
 - **ABE 7CPA412** for connection on a screw terminal block of 4 thermocouple inputs for the **BMX ART 0414/0814** analog module, with supply of cold-junction compensation for these inputs.
 - **ABE 7CPA21** for connection on a screw terminal block of 2 current/voltage outputs of the **BMX AMO 0210** analog module.
- 6 **ABE 7ACC02** sub-base for splitting 16 into 2 x 8 channels, allows connection to an 8-channel sub-base.
- 7 8-channel Optimum or Universal Modicon Telefast ABE 7 passive connection sub-bases or adaptor sub-bases.

(1) Connection of the 24 V $\overline{\text{---}}$ power supply is only possible using Modicon Telefast ABE 7 sub-bases. Equipotentiality of the 0 V $\overline{\text{---}}$ supplies is compulsory.

I/O modules on the Modicon® M340™ platform			1 Discrete 24 V ---					1-b and 1-c Analog				
			Inputs		Outputs		Inputs/outputs	Inputs			Outputs	
			2 x 16 I	4 x 16 I	2 x 16 Q	4 x 16 Q	1 x 16 I 1 x 16 Q	4 I	4 I	2 x 4 I	2 Q	
BMX			DDI 3202K	DDI 6402K	DDO 3202K	DDO 6402K	DDM 3202K	AMI 0410	ART 0414	ART 0814	AMO 0210	
Preformed cordsets (at both ends)	References	BMX	FCC●●1/FCC●●3					FCC●●3	FCA●●0	FCA●●2	FCA●●0	
	Quantity to order		1	2	1	2	1	1	1	2	1	
	Cordset reference to be complete		See page 2/17						See page 2/31			
Passive connection sub-bases												
Optimum	ABE 7H34E●00 "low cost"											
16 channels	ABE 7H16C●● "miniature"											
3												
Universal	ABE 7H08R●●											
8 channels	ABE 7H08S21											
7												
Universal	ABE 7H16R1●●											
16 channels	ABE 7H16R50●											
3	ABE 7H16R2●●											
	ABE 7H16S21●											
	ABE 7H16R3●											
	ABE 7H16R23											
	ABE 7H16S43											
	ABE 7H16F43											
Input adaptor sub-bases with solid state relays												
Universal	ABE 7S16E2●●											
16 channels	Welded solid state relays, removable terminal blocks											
3	ABE 7P16F31●											
	Removable solid state relays											
Output adaptor sub-bases with welded relays, removable terminal blocks												
Optimum & Universal	ABE 7S08S2B●●											
8 channels	Solid state relays											
7	ABE 7R08S111● / 7R08S21●●											
	Electromechanical relays											
Optimum & Universal	ABE 7S16S●B●●											
16 channels	Solid state relays											
3	ABE 7R16S111● / 7R16S21●●											
	Electromechanical relays											
Output adaptor sub-bases with removable relays												
Universal	ABE 7P08T330●											
8 channels	Solid state relays											
7	ABE 7R16T●●● / 7R16M111											
Optimum & Universal	Electromechanical relays											
16 channels	ABE 7P16T●●● / 7P16M111											
3	Solid state and or electromechanical relays											
5 Sub-bases for analog I/O												
4 channels	ABE 7CPA410											
3	ABE 7CPA412											
2 chann. 3	ABE 7CPA21											

Preformed cordsets
(1) Via the ABE 7ACC02 6 splitter sub-base used to separate 16 channels into 2 x 8 channels.

Modicon® M340™ automation platform

Connection interfaces

Modicon® Telefast® ABE 7 pre-wired system

Passive connection sub-bases



ABE 7H34E●●●

Passive connection sub-base for discrete inputs/outputs

Optimum "Low cost" sub-bases

Function	No. of channels	No. of terminals per on row channel number	For PLCs	Length of PLC connection cable	Type of connection	Reference	Weight	
Inputs or outputs	16	1	2	Modicon® M340™	1 m	Screw	ABE 7H34E100	0.330
					2 m	Screw	ABE 7H34E200	0.410
					3 m	Screw	ABE 7H34E300	0.480

Optimum "Miniature" sub-bases

Function	No. of channels	No. of terminals per on row channel number	LED per channel	Polarity distribution	Type of connection	Reference	Weight	
Inputs or outputs	16	1	1	No	No	Screw	ABE 7H16C10	0.160
				Yes	No	Screw	ABE 7H16C11	0.160
		2	2	Yes	0 or 24 V	Screw	ABE 7H16C21	0.205
				3	3	Yes	0 or 24 V	Screw



ABE 7H16C21

Universal sub-bases

Function	No. of channels	No. of terminals per on row channel number	LED per channel	Polarity distribution	Isolator (I) Fuse (F) per channel	Type of connection	Reference	Weight		
Inputs or outputs	8	1	1	No	No	–	Screw	ABE 7H08R10	0.187	
				Yes	No	–	Screw	ABE 7H08R11	0.187	
		2	2	Yes	0 or 24 V	–	Screw	ABE 7H08R21	0.218	
						I	Screw	ABE 7H08S21	0.245	
		16	1	1	No	No	–	Screw	ABE 7H16R10	0.274
					Yes	No	–	Screw	ABE 7H16R11	0.274
	2		2	No	No	–	Screw	ABE 7H16R50	0.196	
						Spring	ABE 7H16R50E	0.196		
	2		2	No	0 or 24 V	–	Screw	ABE 7H16R20	0.300	
				Yes	0 or 24 V	–	Screw	ABE 7H16R21	0.300	
						I	Screw	ABE 7H16S21	0.375	
						Spring	ABE 7H16S21E	0.375		
Inputs	16	2	1	Yes	24 V	I, F (1)	Screw	ABE 7H16S43	0.640	
				Yes	0 V	I, F (1)	Screw	ABE 7H16F43	0.640	



ABE 7H16R50



ABE 7H16R31

(1) LED indicates a blown fuse.

Modicon® M340™ automation platform

Connection interfaces

Modicon® Telefast® ABE 7 pre-wired system

Adaptation sub-bases for Modicon M340 I/O modules

Adaptation sub-bases with soldered relays, removable terminal blocks

Input Universal sub-bases with solid state relays

No. of channels	No. of terminals per channel	Isolation PLC/ Operative part	Voltage	Type of connection	Reference	Weight kg
16	2	Yes	≡ 24 V	Screw	ABE 7S16E2B1	0.370
				Spring	ABE 7S16E2B1E	0.370
			≡ 48 V	Screw	ABE 7S16E2E1	0.370
				Spring	ABE 7S16E2E1E	0.370
			~ 48 V	Screw	ABE 7S16E2E0	0.386
				Spring	ABE 7S16E2E0E	0.386
			~ 110 V	Screw	ABE 7S16E2F0	0.397
				Spring	ABE 7S16E2F0E	0.397
			~ 230 V	Screw	ABE 7S16E2M0	0.407
				Spring	ABE 7S16E2M0E	0.407

Output Universal sub-bases with solid state relays

No. of channels	Isolation API/ Operative part	Output voltage	Output current	Fault detection report (1)	Type of connection	Reference	Weight
8	No	≡ 24 V	0.5 A	Yes (2)	Screw	ABE 7S08S2B0	0.252
					Spring	ABE 7S08S2B0E	0.252
			2 A	Yes (2)	Screw	ABE 7S08S2B1	0.448
					Spring	ABE 7S08S2B1E	0.448
16	No	≡ 24 V	0.5 A	Yes (2)	Screw	ABE 7S16S2B0	0.405
					Spring	ABE 7S16S2B0E	0.405
			Non		Screw	ABE 7S16S1B2	0.400
					Spring	ABE 7S16S1B2E	0.400

Output Optimum & Universal sub-bases with electromechanical relays

No. of channels	Relay width	Number of contacts	Output current	Polarity distribution/ operative part	Type of connection	Reference	Weight kg	
8	5 mm	1 N/O	2 A	Contact common per group of 4 channels	Screw	ABE 7R08S111	0.252	
					Spring	ABE 7R08S111E	0.252	
		Latching	2 A	Volt-free	Screw	ABE 7R08S216	0.448	
					Spring	ABE 7R08S216E	0.448	
	10 mm	1 N/O	5 A	Volt-free	Screw	ABE 7R08S210	0.448	
					Spring	ABE 7R08S210E	0.448	
16	5 mm	1 N/O	2 A	Contact common per group of 8 channels	Screw	ABE 7R16S111	0.405	
					Spring	ABE 7R16S111E	0.405	
		10 mm	1 N/O	5 A	Volt-free	Screw	ABE 7R16S210	0.405
						Spring	ABE 7R16S210E	0.405
	Common per group of 8 channels on both poles				Screw	ABE 7R16S212	0.400	
					Spring	ABE 7R16S212E	0.400	



ABE 7R08S216

(1) A detected fault on a sub-base output Qn will set PLC output Qn to safety mode that will be detected by the PLC.

(2) Can only be used with modules with protected outputs.

Modicon® M340™ automation platform

Connection interfaces

Modicon® Telefast® ABE 7 pre-wired system

Adaptation sub-bases for Modicon M340 I/O modules

Adaptation sub-bases, for plug-in relays

Input Universal sub-bases for solid state relays (1)

No. of channels	No. of terminals per channel	For relay type	Isolation PLC/Operative part	Input connection	Type of connection	Reference	Weight kg
16	2	ABS 7E ABR 7 ABS 7S33E	Yes	Volt-free	Screw	ABE 7P16F310	0.850
					Spring	ABE 7P16F310E	0.850
					Polarity distribution	Screw	ABE 7P16F312

Output Optimum & Universal sub-bases with electromechanical relays (2)

No. of channels	Relay width	For relay type	Number and type of contacts	Polarity distribution/operative part	Reference	Weight kg
16	5 mm	ABR 7S11	1 "F"	Contact common per group of 4 channels	ABE 7R16T111	0,600
				Contact common per group of 4 output channels and 2 common input terminals	ABE 7R16M111 (3)	0,600
	10 mm	ABR 7S21	1 "F"	Volt-free	ABE 7R16T210	0,735
				Common on both poles (4)	ABE 7R16T212	0,730
	12 mm	ABR 7S23	1 "OF"	Volt-free	ABE 7R16T230	0,775
				Common contact (4)	ABE 7R16T231	0,730
12 mm	ABR 7S33	1 "OF"	Volt-free	ABE 7R16T330	1,300	
			Common on both poles (5)	ABE 7R16T332	1,200	
	ABR 7S37	2 "OF"	Volt-free	ABE 7R16T370	1,300	

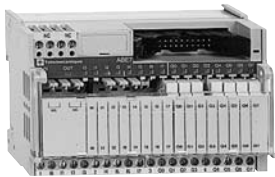

ABE 7R16M111



ABE 7R16T210

(1) Not equipped with relays.

(2) Both technologies (electromechanical and solid state) may be combined on the same sub-base.

(3) 2 connection methods are available, enabling inputs and outputs to be connected to the same sub-base at the same time.

(4) Per group of 8 channels.

(5) Per group of 4 channels.

Modicon® M340™ automation platform

Connection interfaces

Modicon® Telefast® ABE 7 pre-wired system

Sub-bases for Modicon M340 I/O modules

Adaptation sub-bases for plug-in relays

Output Optimum & Universal sub-bases for solid state and/or with electromechanical relays (1)

No. of channels	Relay width	For relay type	Isolator per channel	Fuse per channel	Polarity distribution/operative part	Type of connection	Reference	Weight kg					
16	5 mm	ABR 7S11 ABS 7SC1B	No	No	Contact common per group of 4 channels		ABE 7P16T111	0.550					
							ABE 7P16M111 (2)	0.550					
16	10 mm	ABR 7S2● ABS 7SA2● ABS 7SC2● ABE 7ACC20	No	No	Volt-free	Screw	ABE 7P16T210 (3)	0.615					
							ABE 7P16T230 (3)	0.655					
						Spring	ABE 7P16T230E (3)	0.655					
							Yes	Volt-free	Screw	ABE 7P16T214	0.675		
							No	Common on both poles (4)	Screw	ABE 7P16T212	0.615		
Yes	Common on both poles (4)	Screw	ABE 7P16T215	0.670									
8	12 mm	ABR 7S33 ABS 7A3● ABS 7SC3●● ABE 7ACC21	No	No	Volt-free	Screw	ABE 7P08T330	0.450					
						Spring	ABE 7P08T330E	0.450					
16	12 mm	ABR 7S33 ABS 7A3● ABS 7SC3●● ABE 7ACC21	No	No	Volt-free	Screw	ABE 7P16T330	0.900					
						Spring	ABE 7P16T330E	0.900					
						Screw	Common on both poles (5)	ABE 7P16T332	0.900				
							ABR 7S33 ABS 7A3M	No	Yes	Volt-free	Screw	ABE 7P16T334	0.900
							Yes	Yes	Common on both poles (5)	Screw	ABE 7P16T318	1.000	
Spring	ABE 7P16T318E	1.000											



ABE 7P16T2●●

Connection sub-bases for analog channels

Functions	Compatible modules	Type of connection Modicon® Telefast® ABE 7 side	Type of connection	Reference	Weight kg
Direct connection of 4 thermocouples with cold-junction compensation	BMX ART 0414 BMX ART 0814	25-way SUB-D	Screw	ABE 7CPA412	0,180
Direct connection of 4 analog channels Delivered and distributes 4 protected isolated power supplies	BMX AMI 0410	25-way SUB-D	Screw	ABE 7CPA410	0,180
Direct connection of 2 voltage/current outputs	BMX AMO 0210	25-way SUB-D	Screw	ABE 7CPA21	0,210



ABE 7 CPA 41●/21

(1) Not equipped with relays.

(2) 2 connection methods are available, enabling inputs and outputs to be connected to the same sub-base at the same time.

(3) With relay ABR 7S21 for sub-base ABE 7P16T210, with relay ABR 7S23 for sub-base ABE 7P16T230●.

(4) Per group of 8 channels.

(5) Per group of 4 channels.

Modicon® M340™ automation platform

Connection interfaces

Modicon® Telefast® ABE 7 pre-wired system

Plug-in relays for connection sub-bases

Plug-in solid state relays

Relay width	Functions	Input circuit		Output circuit		Unit reference	Weight kg	
		Current	Nominal voltage	Current (1)	Nominal voltage			
5 mm	Output	---	24 V	2 A	--- 24 V	ABS 7SC1B	0.010	
10 mm	Output	---	24 V	0.5 A	--- 5...48 V	ABS 7SC2E	0.016	
					~ 24...240 V	ABS 7SA2M	0.016	
12 mm	Input	---	5 V TTL	–	--- 24 V	ABS 7EC3AL	0.014	
			24 V Type 2	–	--- 24 V	ABS 7EC3B2	0.014	
			48 V Type 2	–	--- 24 V	ABS 7EC3E2	0.014	
			~ 50 Hz	48 V	–	--- 24 V	ABS 7EA3E5	0.014
			~ 60 Hz	110...130 V	–	--- 24 V	ABS 7EA3F5	0.014
			~ 50 Hz	230...240 V	–	--- 24 V	ABS 7EA3M5	0.014
			Output	---	24 V	2 A Self-protected	--- 24 V	ABS 7SC3BA
			1.5 A	--- 5...48 V	ABS 7SC3E	0.016		
				~ 24...240 V	ABS 7SA3MA	0.016		



ABS 7SC1B

Plug-in electromechanical relays

Relay width	Control voltage	Output current (1)	Number of contacts	Order in multiples of	Unit reference	Weight kg
5 mm	--- 24 V	5 A (lth)	1 N/O	4	ABR 7S11	0.005
10 mm	--- 24 V	5 A (lth)	1 N/O	4	ABR 7S21	0.008
			1 C/O	4	ABR 7S23	0.008
12 mm	--- 24 V	10 A (lth)	1 C/O	4	ABR 7S33	0.017
		8 A (lth)	2 C/O	4	ABR 7S37	0.017
		8 A (lth)	1 C/O	4	ABR 7S33E	0.017
	--- 48 V	8 A (lth)	1 C/O	4	ABR 7S33E	0.017

Accessories

Description	Reference	Weight kg
Extractor for 5 mm miniature relays	ABE 7ACC12	0.010



ABR 7S21



ABR 7S33

Modicon® M340™ automation platform

Connection interfaces

Modicon® Telefast® ABE 7 pre-wired system

Accessories for connection sub-bases

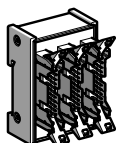

ABE 7ACC02

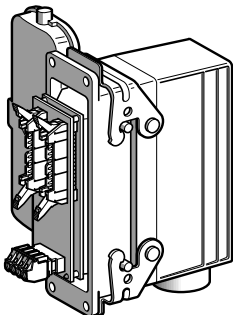

ABE 7ACC80 + ABE 7ACC81

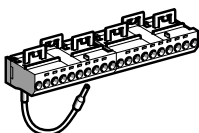

ABE 7BV20

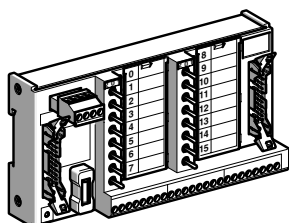

ABE 7TES160

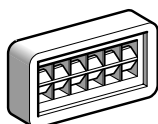

AR1 SB3

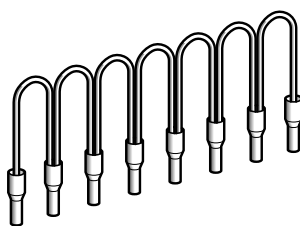

ABE C08R...●●●

Software

Description	Reference	Weight kg
Software for marking customer labels	ABE 7LOGV10	0.350
Pack of 25 pre-cut label sheets (160 labels)	ABE 7LOGF25	0.200

Accessories

Description	No. of channels	Specifications	Order in multiples of	Unit reference	Weight kg
Kit for mounting on solid plate	–	–	10	ABE 7ACC01	0.008
Splitter sub-base	–	16 as 2 x 8 channels	1	ABE 7ACC02	0.075
Plug-in continuity blocks	–	Width 10 mm	4	ABE 7ACC20	0.007
		Width 12 mm	4	ABE 7ACC21	0.010
Locating device for removable terminal block	–	–	100	ABE 7ACC30	0.100
Enclosure feedthrough with industrial connector	32	40-way	1	ABE 7ACC80	0.300
Plug-in 40-way male connector	32	For mounting on ABE 7ACC80	1	ABE 7ACC81	0.370
Enclosure feedthrough with CNOMO M23 connector (1 x 20-way HE 10 connector, PLC end)	16	8 and 12	1	ABE 7ACC82	0.150
		19-way	1	ABE 7ACC83	0.150
Impedance adaptor for Type 2 compatibility	–	Used with ABE 7ACC82 and ABE 7ACC83	1	ABE 7ACC85	0.012
IP 65 cable gland	–	For 3 cables	5	ABE 7ACC84	0.300
Additional snap-on terminal blocks (shunted terminals)	8	10 screw terminals	5	ABE 7BV10	0.030
		10 spring terminals	5	ABE 7BV10E	0.030
	16	20 screw terminals	5	ABE 7BV20	0.060
		20 spring terminals	5	ABE 7BV20E	0.060
I/O simulator sub-base	16	Display, forcing inhibition, continuity	1	ABE 7TES160	0.350
Self-adhesive marker tag holder	–	For 6 characters	50	AR1 SB3	0.001
Quick-blow fuses 5 x 20, 250 V, UL	–	0.125 A	10	ABE 7FU012	0.010
		0.5 A	10	ABE 7FU050	0.010
		1 A	10	ABE 7FU100	0.010
		2 A	10	ABE 7FU200	0.010
		4 A	10	ABE 7FU400	0.010
		6.3 A	10	ABE 7FU630	0.010

Modicon® M340™ automation platform

Connection interfaces

Modicon® Telefast® ABE 7 pre-wired system

Common side view

ABE 7H20E●●●/34E●●●
ABE 7H32E●●●

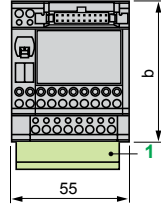
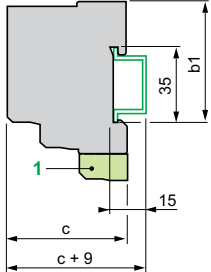

ABE 7H16C●●/ABE 7H16CM●●,
ABE 7●16M111/ABE 7●16T111

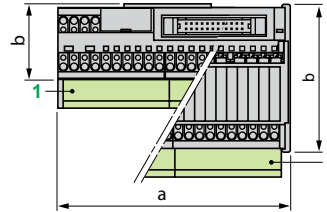

ABE 7H16R50, ABE 7H12R50,
ABE 7H08R1●, ABE 7H08R21,
ABE 7R08S111/S111E,
ABE 7H08S21, ABE 7CPA21/410/412

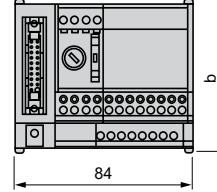

ABE	7H20E/7H32E●●●
b	67
b1	56
c	59

ABE	7H16C●●, 7●16M111, 7H16CM●● 7●16T111
a	106 110
b	49 89
b1	41.5 58
c	60 54

ABE	7H16/12/08●●● 7R08S111● 7CPA21/410/412
b	70 77
b1	58 58
c	58 58

1 Additional shunt terminal block ABE 7BV10/7BV20

Common side view

ABE 7H16R2●, ABE 7H12R2●, ABE 7H16R3●,
ABE 7H16R1●, ABE 7H12R1●, ABE 7H12S21,
ABE 7H16S2●, ABE 7R16S11●, ABE 7R08S210,
ABE 7S08S2B0, ABE 7CPA02, ABE 7CPA03
ABE 7S16S1B2, ABE 7R08S216

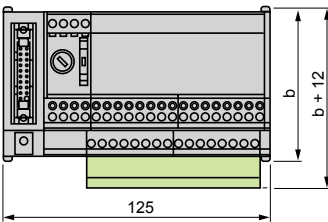
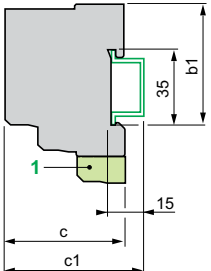

ABE 7R16S21●, ABE 7S16S2B0/S2B02E,
ABE 7S16E2●●/S16E2●●E,
ABE 7S08S2B1/S08S2B1E
ABE 7CPA31

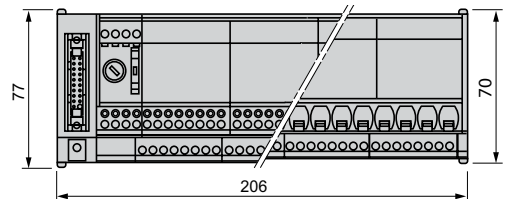

ABE	7●●●●●	7●R08S210●, 7S16S1B2●, 7R08S216
b	70	77
b1	58	58
c	58	58

Sub-bases	
b1	58
c	58

1 Additional shunt terminal block ABE 7BV10/7BV20

ABE 7R16T2●●, ABE 7P16T2●●

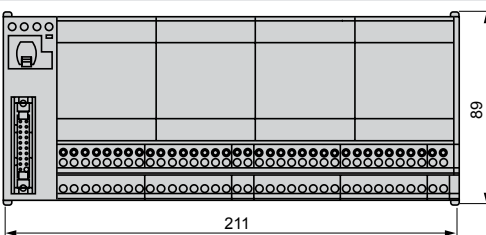
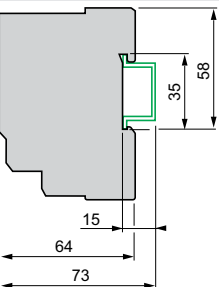

ABE 7CPA01, ABE 7CPA11/CPA12/CPA13

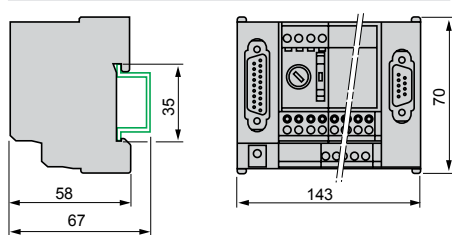

Note : details of the front view are the same as for the ABE 7CPA01.

ABE 7R16T3●●, ABE 7P16T3●●, ABE 7P16F31●

Common side view

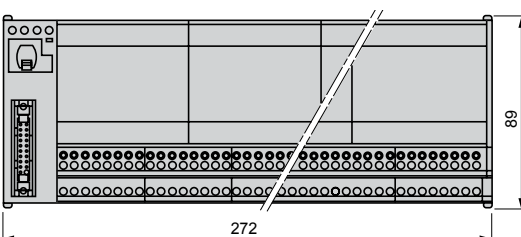
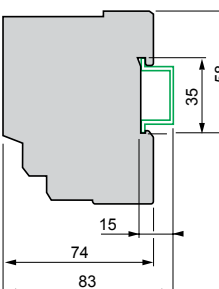

ABE 7P08T330

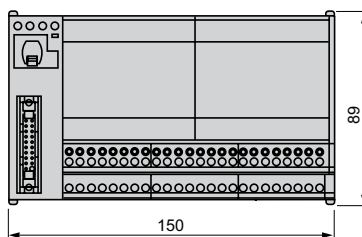

Modicon® M340™ automation platform

Connection interfaces

Modicon® Telefast® ABE 7 pre-wired system

ABE 7ACC02

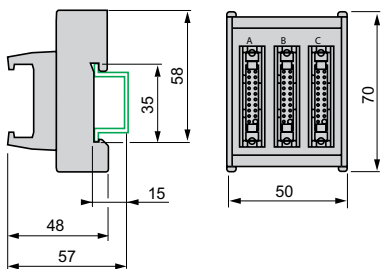

ABE 7ACC03

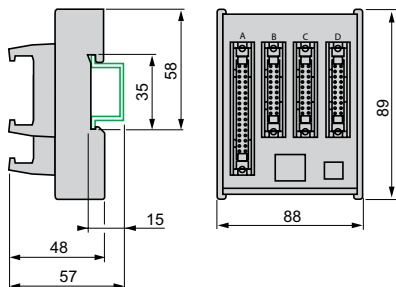

ABE 7ACC04, ABE 7ACC05
ABE 7ACC10, ABE 7ACC11

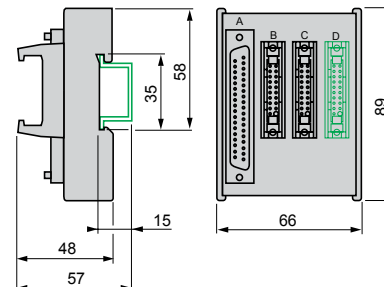

Note: Drawing also represents ABE 7ACC04/05.

ABE 7ACC80

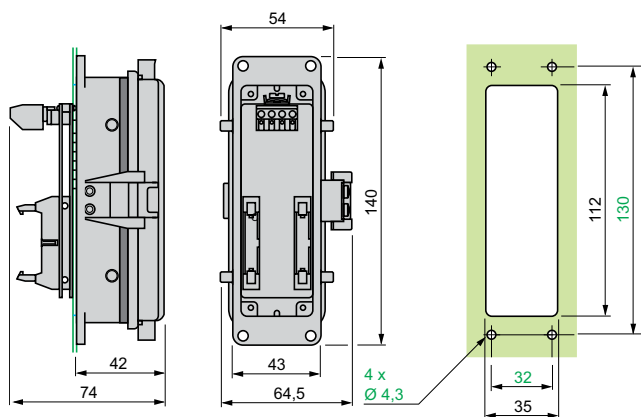

ABE 7ACC82, ABE 7ACC83

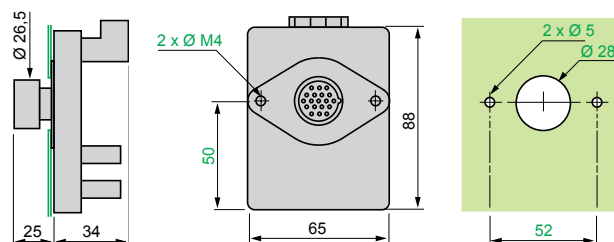

ABE 7ACC84

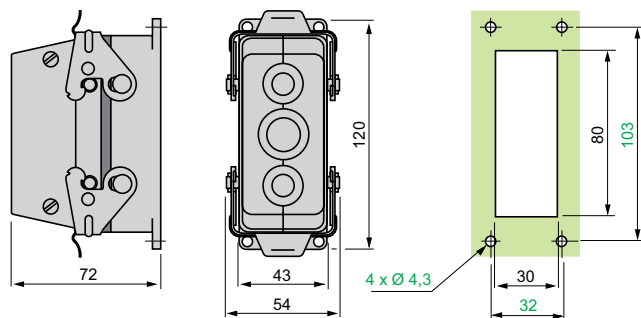

ABE 7TES160

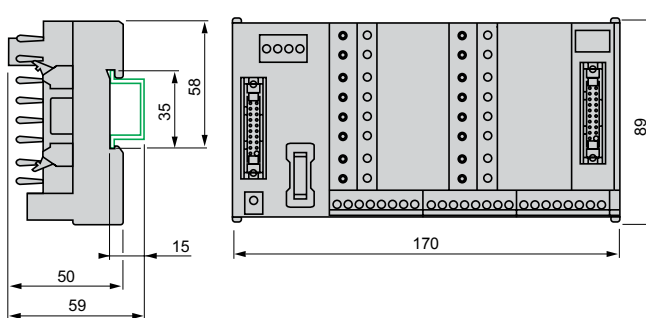

Mounting centers for sub-bases using mounting kit ABE 7ACC01

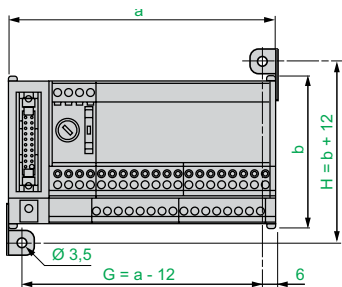

ABE 7	G	H	ABE 7	G	H	ABE 7	G	H
ACC02	38	82	H12R1●	113	82	H16F43	194	82
ACC03	53	101	H12R2●	113	82	H16S43	194	82
ACC04	53	101	H16R1●	113	82	S16E2●●	194	82
ACC05	53	101	H16R2●	113	82	S16S1B2	113	82
ACC10/11	53	101	H16R3●	113	82	S16S2●●	194	82
H08R●●	72	82	H12S21	113	82	R16T2●●	199	101
H08S21	72	82	H16S21	113	82	P16T2●●	199	101
H12R50	72	82	R08S210	113	82	R16T3●●	260	101
H16R50	72	82	R16S111	113	82	P08T330	150	101
R08S111	72	82	R16S21●	194	82	P16T3●●	260	101
CPA01	131	82	S08S2B0	113	82	P16F3●●	260	101
CPA02	113	82	S08S2B1	194	82			
CPA1●	131	82						
CPA03	113	82						

Modicon® M340™ automation platform

Power supplies for DC control circuits
Phaseo® power supplies

Power supplies

Regulated switch mode

Phaseo® Modular and Optimum ranges of industrial power supplies



Input voltage

Connection to different power supplies around the world

- United States
 - 120 V (phase-to-neutral)
 - 240 V (phase-to-phase)
- Europe
 - 230 V (phase-to-neutral)
 - 400 V (phase-to-phase)
- United States
 - 277 V (phase-to-neutral)
 - 480 V (phase-to-phase)

100...240 V ~
120...250 V ☰

Single-phase (N-L1) or
Phase-to-phase (L1-L2) connection

Single-phase connection (N-L1)

–

IEC/EN 61000-3-2 conformity

Undervoltage control

Short-circuit and overload protection

Diagnostic relay

Compatibility with function modules

Power reserve (Boost)

Yes for ABL 7RP, not for ABL 8REM and not applicable for ABL 8MEM and ABL 7RM

Yes

Yes, voltage detection. Automatic reset on correction of the detected fault

–

–

1.25 to 1.4 I_n for 1 minute, depending on model (for ABL 8MEM)

No

Output voltage

Output current

- 0.3 A
- 0.6 A
- 1.2 A
- 2 A
- 2.5 A
- 3 A
- 4 A
- 5 A
- 6 A
- 10 A
- 20 A
- 40 A

5 V ☰

12 V ☰

24 V ☰

48 V ☰

ABL 8MEM24003
(Modular)

ABL 8MEM24006
(Modular)

ABL 8MEM24012
(Modular)

ABL 8MEM12020
(Modular)

ABL 7RM24025
(Modular)

ABL 7RP4803
(Optimum)

ABL 8REM24030
(Optimum)

ABL 8MEM05040
(Modular)

ABL 7RP1205
(Optimum)

ABL 8REM24050
(Optimum)

Pages

Please consult the "Phaseo® Power Supplies and Transformers catalog."

Regulated switch mode
Phaseo® Universal range of industrial power supplies



100...120 V ~ and 200...500 V ~ (1)	380...500 V ~	24 V ---	
Single-phase (N-L1) or Phase-to-phase (L1-L2) connection	–	–	
	3-phase connection (L1-L2-L3)	–	
	3-phase connection (L1-L2-L3)	–	
Yes	–		
Yes	–		
Yes, current limitation or undervoltage detection	Yes, current limitation		
Yes, depending on model			
Yes with buffer module, battery and battery check modules, redundancy module and discriminating downstream protection module			
1.5 In for 4 seconds		No	
24 V ---		5 V ---	7...12 V ---
			ABL 8DCC12020 (2)
		ABL 8DCC05060 (2)	

5/25 Please consult the "Phaseo® Power Supplies and Transformers" catalog.
 (1) Except **ABL 8RPM24200**, 100...120 V ~ and 200...240 V ~.
 (2) DC/DC converter module must be used with a Phaseo® Universal power supply.

Modicon® M340™ automation platform

Power supplies for DC control circuits
Regulated switch mode power supplies
Phaseo® Universal range

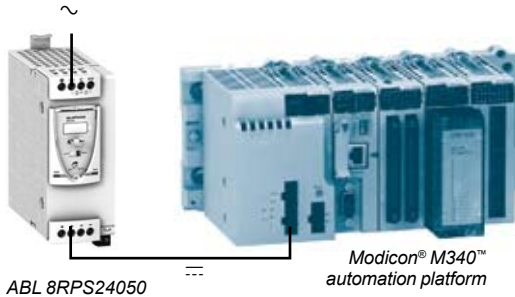

Switch mode power supplies: Universal range

The **ABL 8RPS/RPM/WPS** power supply offer is designed to provide the DC voltage necessary for the control circuits of automation system equipment. Comprised of six products, this range meets the needs encountered in industrial and commercial applications. These compact electronic switch mode power supplies provide a quality of output current that is suitable for the loads supplied and compatible with the Modicon® M340™, Premium™ and Quantum™ ranges. When used with additional function modules, they help ensure continuity of service in the event of power outages or application malfunctions. Clear guidelines are given on selecting the function modules and upstream protection devices that are often used with them, providing a comprehensive solution.

The Universal range of Phaseo® power supplies must be connected in phase-to-neutral or phase-to-phase for **ABL 8RPS/RPM**, and in three-phase for **ABL 8WPS**. They deliver a voltage that is precise to 3%, whatever the load and whatever the type of line supply, within the ranges:

- 85 to 132 V ~ and 170 to 550 V ~ for **ABL 8RPS**
- 85 to 132 V ~ and 170 to 264 V ~ for **ABL 8RPM**
- 340 to 550 V ~ for **ABL 8WPS**

Their very wide input voltage range allows a considerable reduction of parts held in stock and offers a distinct advantage in terms of machine design.

Conforming to IEC standards and UL and CSA certified, they are suitable for universal use.

ABL 8RPS/RPM and **ABL 8WPS** power supplies are equipped with a harmonic filter that helps ensure compliance with standard IEC/EN 61000-3-2 concerning harmonic pollution.

The Universal range of Phaseo power supplies has protection devices to help ensure optimum performance of the automation system. Their operating mode can be configured as required by the user:

- **Manual reset protection mode:** Priority is given to the voltage to help guarantee the PLC logic states and nominal operation of the supplied actuators.
- **Automatic reset protection mode:** Priority is given to the current to allow troubleshooting for example, or to help ensure continuity of service until the arrival of the maintenance team.

The Universal range of Phaseo power supplies also has a power reserve, allowing them to deliver a current of 1.5 I_n at regular intervals. This avoids the need to oversize the power supply if the device has a high inrush current, while helping to ensure optimum performance of the automation system.

The diagnostics for the Universal range of Phaseo power supplies are available on the front of the device via LEDs (U_{out} and I_{out}) and via a volt-free relay contact.

Products are equipped with an output voltage adjustment potentiometer to compensate for any line voltage drops in installations with long cable runs.

These power supplies are designed for direct mounting on a 35 mm DIN rail.

Modicon® M340™ automation platform

Power supplies for DC control circuits
Regulated switch mode power supplies
Phaseo® Universal range



ABL 8WPS24200



Premium automation platform

Switch mode power supplies: Universal range (continued)

There are four references available in the Universal range of Phaseo® power supplies for phase-to-neutral or phase-to-phase connection:

■ ABL 8RPS24030	72 W	3 A	24 V $\overline{\text{---}}$
■ ABL 8RPS24050	120 W	5 A	24 V $\overline{\text{---}}$
■ ABL 8RPS24100	240 W	10 A	24 V $\overline{\text{---}}$
■ ABL 8RPM24200	480 W	20 A	24 V $\overline{\text{---}}$

The Universal range of Phaseo power supplies also features two references for 3-phase connection:

■ ABL 8WPS24200	480 W	20 A	24 V $\overline{\text{---}}$
■ ABL 8WPS24400	960 W	40 A	24 V $\overline{\text{---}}$

A range of function modules also allows functions to be added to the Universal range of Phaseo power supplies to help ensure continuity of service:

- A Buffer module or Battery control modules combined with their batteries to help ensure continuity of service in the event of a network power outage
- A Redundancy module to meet the most demanding requirements for continuity of service even if the power supply becomes inoperative
- Downstream electronic protection modules to help ensure that the protection in the application is discriminating
- Converter modules delivering nominal voltages of 5 and 12 V $\overline{\text{---}}$ from the 24 V $\overline{\text{---}}$ output of the Universal range of Phaseo power supplies

Description

Universal range of power supplies

The **ABL 8RPS24●●0/RPM24200/WPS24●00** Universal range of Phaseo regulated switch mode power supplies comprise:

- 1 Spring clip for 35 mm DIN rail
- 2 4 mm² cage clamp terminals for connection of the AC voltage (single-phase, phase-to-phase or 3-phase connection)
- 3 Protective glass flap
- 4 Clip-on marker label
- 5 Locking catch for the glass flap (sealable)
- 6 Protection mode selector
- 7 Output voltage adjustment potentiometer
- 8 Output voltage status LED (green and red)
- 9 Output current status LED (green, red, and orange)
- 10 Screw terminals for connection of the diagnostic relay contact, except for **ABL 8RPS24030**
- 11 4 mm² (10 mm² on **ABL 8WPS24●00** and **ABL 8RPM24200**) cage clamp terminals for connection of the DC output voltage

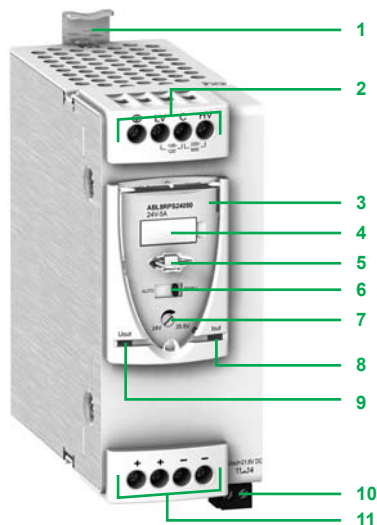

Modicon® M340™ automation platform

Power supplies for DC control circuits
Regulated switch mode power supplies
Phaseo® Universal range

Technical specifications

Type of power supply		ABL 8RPS24030	ABL 8RPS24050	ABL 8RPS24100	ABL 8RPM24200	
Certifications		CB scheme EN 60950-1, UL, cCSAus, CE, C-Tick				
Conforming to standards	Safety	IEC/EN 60950-1, EN 61204, SELV				
	EMC	EN 61000-6-1, IEC/EN 61000-6-2, EN 61000-6-3, EN 61000-6-4, IEC/EN 61204-3, IEC/EN 61204-3				
Input circuit						
Input values phase-to-neutral (N-L1) or phase-to-phase (L1-L2)	Nominal voltages	V	100...120 V ~/200...500 V ~		100...120 V ~/ 200...240 V ~	
	Voltage range	V	85...132 V ~/170...550 V ~		85...132 V ~/ 170...264 V ~	
	Permissible frequencies	Hz	47...63			
	Maximum inrush current	A	30 for 2 ms max.			
	Power factor		0.59 at 120 V ~/0.51 at 240 V ~		0.69 at 120 V ~/0.68 at 240 V ~	
	Efficiency at nominal load		> 87%		> 88%	
	Dissipated power at nominal load	W	7.8	15.5	31	57.6
Anti-harmonic filtering	According to IEC/EN 61000-3-2	Yes, via integrated PFC (<i>Power Factor Correction</i>) passive filter				
Output circuit						
Compatibility with function modules		Buffer, battery and battery check unit, redundancy, discriminating protection				
Diagnostics	LEDs on front panel	Current (green, orange and red), voltage (green, red and off)				
	Relay	-		Relay closed $U_{out} > 21.6$ V contact 230 V ~, 0.5 A max.; 24 V ---, 5 mA min.		
Nominal output values	Output voltage (U_{out})	V	24 ---			
	Current	A	3	5	10	20
	Power	W	72	120	240	480
Permissible temporary inrush current (boost)		A	1.5 I_n for 4 s maximum. See Curves on page 5/23.			
Precision	Output voltage (U_{out})	V	Adjustable 24...28.8			
	Line and load regulation		1%...3%			
	Residual ripple - noise	mV	< 200 (peak-peak)			
Holding time for I_{max}	$U_{in} = 100$ V ~	ms	≥ 20			
	$U_{in} = 240$ V ~	ms	≥ 40			
	$U_{in} = 400$ V ~	ms	≥ 120			
Protection	Against short-circuits		Permanent, automatic or manual restart			
	Against overloads		Permanent, automatic or manual restart			
	Against overvoltages	V	30...32 ---, automatic or manual restart			
	Against undervoltages	V	Tripping if $U_{out} < 21.6$ (manual mode)			
	Thermal		Yes, automatic restart only			
Operational and environmental specifications						
Connections	Input	mm ²	2 x 0.5...4 screw terminals (22...12 AWG) + ground terminal			
	Output	mm ²	4 x 0.5...4 screw terminals (22...12 AWG) + ground terminal (1)			
	Diagnostic relay	mm ²	-	2 x 2.5 removable screw terminal block		
Mounting	On DIN rail		35 x 7.5 mm and 35 x 15 mm			
Operating position			Vertical			
Connections	Series		Possible, see page 5/24			
	Parallel		Possible, see page 5/24			
Degree of protection	According to IEC 60529		IP 20		IP 20 except output terminals (+, -) IP 10	
Environment	Operating temperature	°C	- 25...+ 60 (derating from 50°C, see page 5/22)			
	Storage temperature	°C	- 40...+ 70			
	Maximum relative humidity		90% during operation, 95% in storage			
	Vibration acc. to IEC/EN 61131-2		3...11.9 Hz amplitude 3.5 mm & 11.9 -150 Hz acceleration 2 g			
Protection class	According to VDE 0106 1		Class I			
Dielectric strength 50 Hz for 1 min	Input/output	V rms	4000 ~		3000 ~	
	Input/ground	V rms	3500 ~		2500 ~	
	Output/ground	V rms	500 ~			
Input fuse incorporated			No			
Emission according to EN 61000-6-3	Radiation		EN 55022 Class B and GL levels			
	Conducted on the power line		EN 55022 Class B and GL levels			
	Harmonic currents		IEC/EN 61000-3-2			
Immunity according to IEC/EN 61000-6-2	Electrostatic discharge		IEC/EN 61000-4-2 (8 kV contact/15 kV air)			
	Radiated electromagnetic fields		IEC/EN 61000-4-3 level 3 (10 V/m)			
	Induced electromagnetic fields		IEC/EN 61000-4-6 level 3 (30 V/m)			
	Rapid transients		IEC 61000-4-4 (4 kV)			
	Surges, IEC/EN 61000-4-5		Input: 4 kV in common mode, 2 kV in differential mode Output: 2 kV in common mode, 1 kV in differential mode			
Primary outages			IEC 61000-4-11 (voltage dips and interruptions)			

(1) No ground screw on ABL 8RPM 24200 power supply.

Modicon® M340™ automation platform

Power supplies for DC control circuits
Regulated switch mode power supplies
Phaseo® Universal range

Technical specifications					
Type of power supply		ABL 8WPS24200		ABL 8WPS24400	
Certifications		CB scheme EN 60950-1, UL, cCSAus, CE, C-Tick			
Conforming to standards	Safety	IEC/EN 60950-1, EN 61204, SELV			
	EMC	EN 61000-6-1, IEC/EN 61000-6-2, EN 61000-6-3, IEC/EN 61000-6-4, IEC/EN 61204-3			
Input circuit					
Input values 3-phase (L1-L2-L3)	Nominal values	V	380-500 V ~		
	Permissible values	V	320-550 V ~		
	Permissible frequencies	Hz	47...63		
	Maximum inrush current	A	25 for 2 ms max.		
	Power factor		0.65	0.85	
	Efficiency at nominal load		> 92%		
	Dissipated power at nominal load	W	38.4	76.8	
Anti-harmonic filtering	According to IEC/EN 61000-3-2	Yes, via integrated PFC (Power Factor Correction) passive filter			
Output circuit					
Compatibility with function modules		Buffer, battery and battery check unit, redundancy, discriminating protection			
Diagnostics	LEDs on front panel	Current (green, orange and red), voltage (green, red and off)			
	Relay	Closed relay $U_{out} > 21.6$ V, contact 230 V ~, 0.5 A max; 24 V ---, 5 mA min			
Nominal output values	Output voltage (U_{out})	V	24 ---		
	Current	A	0...20	0...40	
	Power	W	480	960	
Permissible temporary inrush current (boost)		A	1.5 I_n for 4 s maximum. See Curves on page 5/23.		
Precision	Output voltage (U_{out})	V	Adjustable 24...28.8		
	Line and load regulation		1%...3%		
	Residual ripple - noise	mV	< 200 (peak-peak)		
Holding time for I_{max}	$U_{in} = 400$ V ~	ms	≥ 18	≥ 14	
Protection	Against short-circuits	Permanent, automatic or manual restart			
	Against overloads	Permanent, automatic or manual restart			
	Against overvoltages	V	30...32 ---, automatic or manual restart		
	Against undervoltages	V	Tripping if $U_{out} < 21.6$ (in manual mode)		
	Thermal	Yes, automatic restart only			
Operational and environmental specifications					
Connections	Input	mm ²	3 x 0.5...4 screw terminals (22...12 AWG) + earth		
	Output	mm ²	4 x 0.5...10 screw terminals (22...8 AWG)		
	Diagnostic relay	mm ²	2 x 2.5 removable screw terminal block		
Mounting	On DIN rail	35 x 7.5 mm and 35 x 15 mm			
Operating position		Vertical			
Connections	Series	Possible (see page 5/24)			
	Parallel	Possible (see page 5/24)			
Degree of protection	According to IEC/EN 60529	IP 20 except output terminals (+, -) IP 10			
Environment	Operating temperature	°C	- 25...+ 60 (derating from 50°C, see page 5/22)		
	Storage temperature	°C	- 40...+ 70		
	Maximum relative humidity	90% during operation, 95% in storage			
	Vibration acc. to IEC/EN 61131-2	3...11.9 Hz amplitude 3.5 mm & 11.9 -150 Hz acceleration 2 g			
Protection class, according to VDE 0106 1		Class I			
Dielectric strength 50 Hz for 1 min	Input/output	V rms	4000 ~		
	Input/ground	V rms	3500 ~		
	Output/ground	V rms	500 ~		
Input fuse incorporated		No			
Emission according to EN 61000-6-3	Radiation	EN 55022 Class B and GL levels			
	Conducted on the power line	EN 55022 Class B and GL levels			
	Harmonic currents	IEC/EN 61000-3-2			
Immunity according to IEC/EN 61000-6-2	Electrostatic discharge	IEC/EN 61000-4-2 (8 kV contact/15 kV air)			
	Radiated electromagnetic fields	IEC/EN 61000-4-3 level 3 (10 V/m)			
	Induced electromagnetic fields	IEC/EN 61000-4-6 level 3 (30 V/m)			
	Rapid transients	IEC 61000-4-4 (4 kV)			
	Surges, IEC/EN 61000-4-5	Input: 4 kV in common mode, 2 kV in differential mode Output: 2 kV in common mode, 1 kV in differential mode			
	Primary outages	IEC 61000-4-11 (voltage dips and interruptions)			



Modicon® M340™ automation platform

Power supplies for DC control circuits
Regulated switch mode power supplies
Phaseo® Universal range

Output specifications

Derating

The ambient temperature is a determining factor which limits the power that an electronic power supply can deliver continuously. If the temperature around the electronic components is too high, their life will be significantly reduced.

The nominal ambient temperature for the Universal range of Phaseo® power supplies is 50°C. Above this temperature, derating is necessary up to a maximum temperature of 60°C.

The graph below shows the power (in relation to the nominal power) that the power supply can deliver continuously, according to the ambient temperature.

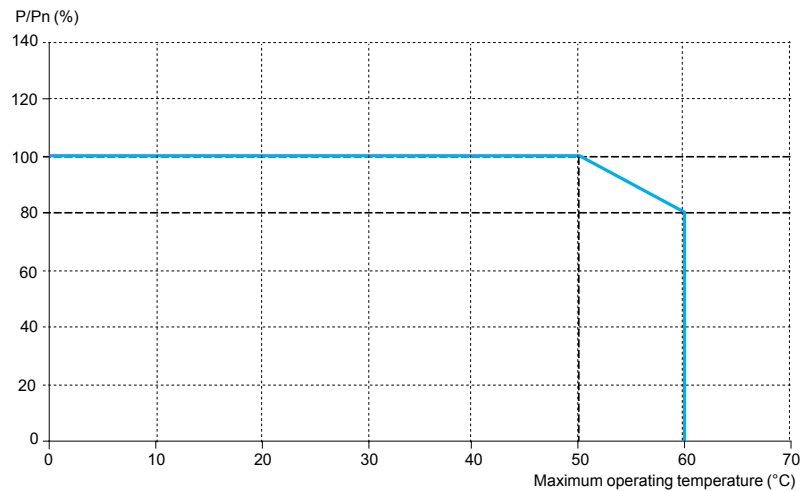

ABL 8RPM, ABL 8RPS, ABL 8WPS mounted vertically

Derating should be considered in extreme operating conditions:

- Intensive operation (output current permanently close to the nominal current, combined with a high ambient temperature)
- Output voltage set above 24V (to compensate for line voltage drops, for example)
- Parallel connection to increase the total power

General rules to be followed

Intensive operation	See derating on graph above. Example for ABL 8RPS: - Without derating, from 0°C to 50°C - Derating of nominal current by 2% per additional°C, up to 60°C
Rise in output voltage	The nominal power is fixed. Increasing the output voltage means that the current delivered is reduced.
Mounting	To allow heat dissipation, the power supplies must not be in contact with each other.

There must be adequate convection around the products to assist cooling. There must be sufficient clearance around the Universal range of Phaseo power supplies:

- 50 mm above and below
- 10 mm on the sides

Output specifications (continued)

Behavior in the event of overloads

Behavior in the event of overloads:

■ **Automatic reset protection mode (current limiting):** If the output current exceeds approximately $1.2 I_n$, the output current is limited to this value. The value of the output voltage can then be less than 21 V but the diagnostic relay opens, allowing the anomaly to be fed back to the automation system which will prevent feedback of any undefined logic state. On elimination of the overload, the output voltage reverts to its preset value.

■ **Manual reset protection mode (undervoltage detection):** If the output current exceeds approximately $1.2 I_n$, the power supply stops completely before the output voltage drops below 21 V and no longer delivers any current. The detected fault is memorized as long as voltage is present at the power supply primary. The power supply will become operational again, if the detected fault has disappeared, after de-energizing the primary for a few seconds.

Note: In these modes, any overload of less than $1.5 I_n$ and lasting less than 4 s will be absorbed by the "boost" circuit. The voltage delivered will stay within the specified limits (adjustment voltage $\pm 3\%$).

Load limit

Manual reset protection mode

ABL 8RPM24200/ABL 8RPS24●●●/ABL 8WPS24●●●

Automatic reset protection mode

ABL 8RPM24200/ABL 8RPS24●●●/ABL 8WPS24●●●

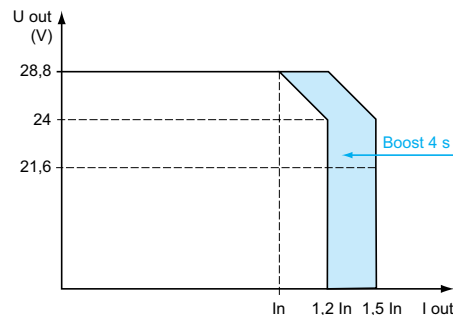
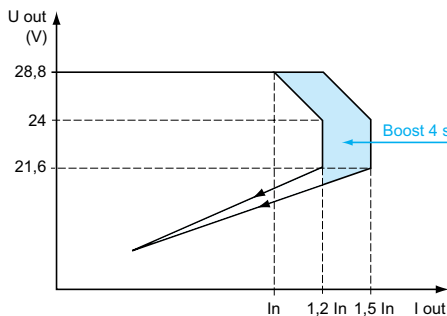

"Boost" repeat accuracy

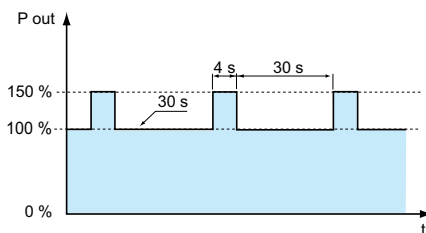

The ABL 8RPS/RPM/WPS Universal range of Phaseo® power supplies has a power reserve, allowing them to supply the application with energy up to 1.5 times the nominal current at the intervals illustrated by the graph on the left.

The "boost" amplitude and repeat accuracy depend on:

- The duration of the overload
- The intensity of the overload
- The period between each consumption peak

When the power supply can no longer cope (repeated overloads, overload duration > 4 seconds, power rating > 150% of nominal power) the integrated protection trips.

This type of operation is described in detail in the user manual that can be downloaded from our website, www.schneider-electric.us/.

Behavior in the event of phase failure on three-phase power supplies

The ABL 8WPS24●00 Universal range of Phaseo power supplies is capable of starting and delivering a nominal current and voltage for a few minutes in the event of failure of one phase. Their protection (thermal) then trips and they are reset automatically.

Output specifications (continued)

Series or parallel connection

Series connection

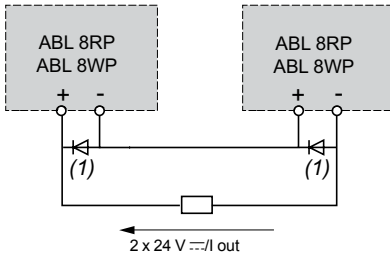

Parallel connection

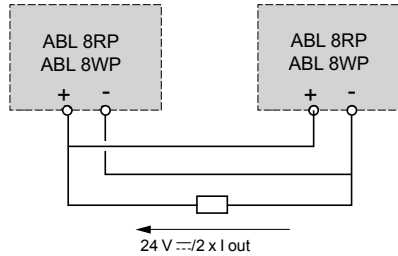

Family	Series	Parallel
ABL 8RPS/8RPM/8WPS	2 products max. (1)	2 products max.

Note: Series or parallel connections are only recommended for products with identical references.

For enhanced dependability, the power supplies can also be connected in parallel using the **ABL8 RED24400** Redundancy module.

Selection of protection on the power supply primaries

Type of line supply	115 V ~ phase-to-neutral			230 V ~ phase-to-phase			400 V ~ phase-to-phase	
	Thermal-magnetic circuit-breaker	gG/gL fuse		Thermal-magnetic circuit-breaker	gG/gL fuse		Thermal-magnetic circuit-breaker	gG/gL fuse
ABL 8RPS24030	(2) GB2 (IEC) (4) GB2 CD07	(3) C60N (IEC/UL) MG24443	-	(2) GB2 (IEC) (4) GB2 CD07	(3) C60N (IEC/UL) MG24443	-	(2) GV2 (IEC/UL) GV2 RT06	-
ABL 8RPS24050	GB2 CD08	MG24444	4 A (8 x 32)	GB2 CD07	MG24443	2 A (8 x 32)	GV2 RT06	2 A (14 x 51)
ABL 8RPS24100	GB2 CD12	MG24447	6 A (8 x 32)	GB2 CD08	MG24444	4 A (8 x 32)	GV2 ME06 (5)	2 A (14 x 51)
ABL 8RPM24200	GB2 CD16	MG24449	10 A (8 x 32)	GB2 CD12	MG24447	6 A (8 x 32)	GV2 RT07	4 A (14 x 51)
ABL 8WPS24200	-	-	-	-	-	-	GV2 ME07 (5)	-
ABL 8WPS24400	-	-	-	-	-	-	GV2 ME06 (6)	2 A (14 x 51)
							GV2 ME07 (5)	4 A (14 x 51)

Connections

GB2 CD●●



GV2 RT●●

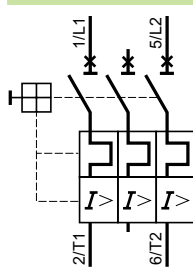

GV2 ME●●

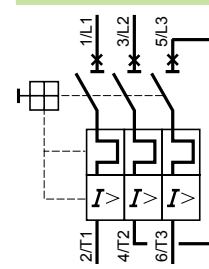

(5) Single-phase (N-L1) or 2-phase (L1-L2) connection

(6) 3-phase connection (L1-L2-L3)

(1) Two Schottky diodes I_{min} = power supply I_n and V_{min} = 50 V
(2) Automation and Control offer
(3) Electrical Distribution offer
(4) UL certification pending

Modicon® M340™ automation platform

Power supplies for DC control circuits
Regulated switch mode power supplies
Phaseo® Universal range



ABL 8RPS24050



ABL 8RPM24200



ABL 8WPS24200



ABL 8BUF24400



ABL 8BBU24200



ABL 8RED24400

Phaseo regulated switch mode power supplies: Universal range

Input voltage	Secondary		Reset	IEC/EN 61000-3-2 conformity	Reference	Weight kg	
	Output voltage	Nominal power					Nominal current
Single-phase (N-L1) or 2-phase (L1-L2) connection							
100...120 V	24...28.8 V	72 W	3 A	Auto/man	Yes	ABL 8RPS24030	0.300
~ - 200...500 V - 15%, + 10%	---	120 W	5 A	Auto/man	Yes	ABL 8RPS24050	0.700
50/60 Hz	---	240 W	10 A	Auto/man	Yes	ABL 8RPS24100	1.000
100...120 V ~/ 200...240 V - 15%, + 10%	24...28.8 V ---	480 W	20 A	Auto/man	Yes	ABL 8RPM24200	1.600
50/60 Hz	---	960 W	40 A	Auto/man	Yes	ABL 8WPS24400	2.700
3-phase connection (L1-L2-L3)							
380...500 V ~ ± 10%	24...28.8 V ---	480 W	20 A	Auto/man	Yes	ABL 8WPS24200	1.600
50/60 Hz	---	960 W	40 A	Auto/man	Yes	ABL 8WPS24400	2.700

Function modules for continuity of service (1)

Function	Use	Description	Reference	Weight kg
Continuity after a power outage	Holding time 100 ms at 40 A and 2 s at 1 A	Buffer module	ABL 8BUF24400	1.200
	Holding time 9 min at 40 A...2 hrs at 1 A (depending on use with a battery check module-battery unit and load) (2)	Battery check module, 20 A output current	ABL 8BBU24200	0.500
		Battery check module, 40 A output current	ABL 8BBU24400	0.700
		3.2 Ah battery module (3)	ABL 8BPK24A03	3.500
		7 Ah battery module (3)	ABL 8BPK24A07	6.500
		12 Ah battery module (3)	ABL 8BPK24A12	12.000
Continuity after a disruption	Paralleling and redundancy of the power supply to help ensure uninterrupted operation of the application excluding supply failures and application overloads	Redundancy module	ABL 8RED24400	0.700
Discriminating downstream protection	Electronic protection (1...10 A overload or short-circuit) of 4 output terminals from a Phaseo Universal range power supply	Protection module with 2-pole breaking (4) (5)	ABL 8PRP24100	0.270

DC/DC converters (1)

Primary (6)	Secondary		Reference	Weight kg	
	Input voltage	Universal range power supply module output current			Output voltage
24 V --- - 9%, + 24%	2.2 A	5...6.5 V ---	6 A	ABL 8DCC05060	0.300
	1.7 A	7...15 V ---	2 A	ABL 8DCC12020	0.300

Separate and replacement parts

Description	Use	Composition	Unit reference	Weight kg
Fuse assemblies	ABL 8PRP24100 discriminating Protection module	4 x 5 A, 4 x 7.5 A and 4 x 10 A	ABL 8FUS01	—
	ABL 8BPK24A battery	4 x 20 A and 6 x 30 A	ABL 8FUS02	—
Clip-on marker labels	Any product except ABL 8PRP24100	Order in multiples of 100	LAD 90	0.030
	ABL 8PRP24100 discriminating Protection module	Order in multiples of 22	ASI20 MACC5	—
DIN rail mounting kit	ABL 8BPK2403 battery module	—	ABL 1A02	—
EEPROM memory	Backup and duplication of ABL 8BBU24 battery check module parameters	—	SR2 MEM02	0.010

(1) For use with Universal range Phaseo® power supply

(2) Compatibility table for battery check module-battery unit with holding time depending on the load

(3) Supplied with 20 or 30 A fuse depending on the model

(4) Supplied with four 15 A fuses

(5) Local reset via pushbutton or automatic reset on elimination of the detected fault

(6) Voltage from a 24 V --- Universal range Phaseo power supply

Dimensions

ABL 8RPS24.../ABL 8RPM24200/ABL 8WPS24...
Common side view

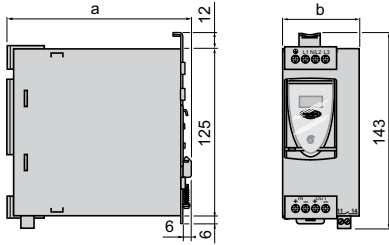

ABL 8	a	b
RPS24030	120	44
RPS24050	120	56
RPS24100	140	85
RPM24200	140	145
WPS24200	155	95
WPS24400	155	165

Internal connections

ABL 8RPS24030

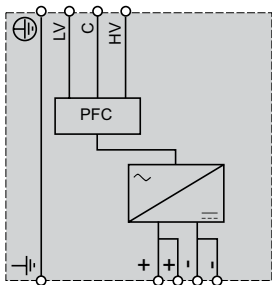

ABL 8RPS24050

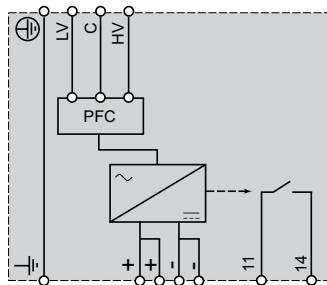

ABL 8RPS24100

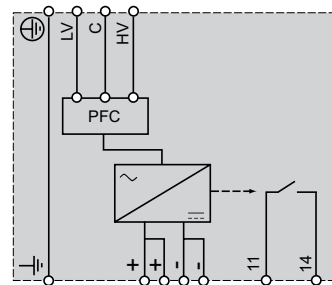

ABL 8RPM24200

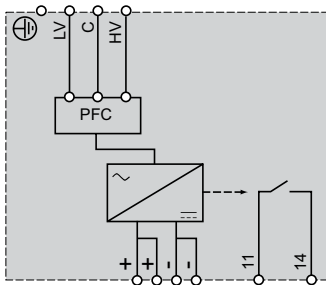

ABL 8WPS24200

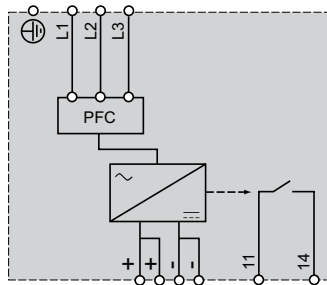

ABL 8WPS24400

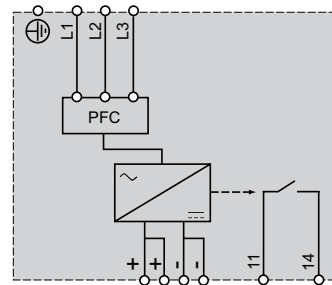

5

Modicon® M340™ automation platform

Power supplies for DC control circuits
Regulated switch mode power supplies
Phaseo® Universal range

Line supply connection diagrams

Single-phase (L-N) 100 to 120 V

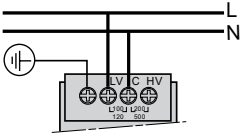

Phase-to-phase (L1-L2) 200 to 500 V

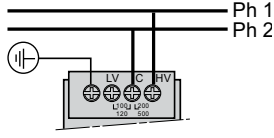

3-phase (L1-L2-L3) 3 x 380 to 500 V

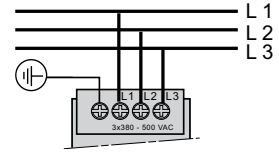

Single-phase (L-N) 200 to 500 V

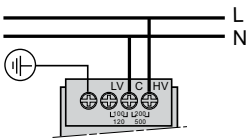

Modicon® M340™ automation platform

Operator dialog terminals
Magelis® Small Panels

Applications

Display of text messages

Terminal type

Small Panels with keypad



Display	Type
	Capacity

Green backlit LCD, height 5.5 mm or Green, orange or red backlit LCD, height 4.34...17.36 mm
2 lines of 20 characters or 1 to 4 lines of 5 to 20 characters

Data entry

Via keypad with
8 keys (4 customizable)

Memory capacity	Application
	Expansion by PCMCIA type II

512 KB Flash
–

Functions	Maximum number of pages
	Variables per page
	Reintroduction of variables
	Recipes
	Curves
	Alarm logs
	Real-time clock
	Alarm relay
	Buzzer

128/200 application pages 256 alarm pages
40...50
Alphanumeric
–
–
Depending on model
Access to the PLC real-time clock
–
–

Communication	Asynchronous serial link
	Downloadable protocols
	Printer link

RS 232C/RS 485
Uni-TE™, Modbus®, and for PLC brands: Allen-Bradley, Omron, Mitsubishi, Siemens
RS 232C serial link (2)

Programming software
Operating system

Vijeo® Designer™ Lite (on Windows 2000®, XP® and Vista®)
Magelis®

Terminal type

XBT N

Pages

Consult our "Human/Machine Interfaces" catalog

(1) XBT RT511 only.
(2) Depending on model

Display of text messages Control and configuration of data	Display of text messages and/or semi-graphics Control and configuration of data
---	--

Small Panels with keypad	Small Panels with touch screen and keypad
---------------------------------	--



Green, orange or red backlit LCD, height 4.34...17.36 mm	Green, orange or red backlit matrix LCD (198 x 80 pixels) height 4...16 mm
1 to 4 lines of 5 to 20 characters	2 to 10 lines of 5 to 33 characters

Via keypad with 12 function keys or numeric entry (depending on context) + 8 service keys	Via keypad with 4 function keys 8 service keys	Via touch screen and keypad with 10 function keys 2 service keys
---	--	--

512 KB Flash	512 KB Flash EPROM
-	-

128/200 application pages 256 alarm pages	200 application pages 256 alarm pages
40...50	50
Alphanumeric	Alphanumeric, bargraph, buttons, lamps
-	-
-	Yes
Yes	Yes
Access to the PLC real-time clock	
-	
-	Yes (1)

RS 232C/RS 485
Uni-TE™, Modbus®, and for PLC brands: Allen-Bradley, Omron, Mitsubishi, Siemens
RS 232C serial link (2)

Vijeo® Designer™ Lite (on Windows 2000®, XP® and Vista®)
Magelis®

XBT R	XBT RT
--------------	---------------

Consult our catalog "Human/Machine Interfaces"

Modicon® M340™ automation platform

Operator dialog terminals
Magelis® XBT GT, XBT GK and XBT GTW
Advanced Panels

Applications		Display of text messages, graphic objects and synoptic views Control and configuration of data		
Type of terminal		Touch screen Advanced Panels		
Display				
Type	Capacity	Backlit monochrome (amber or red mode) STN LCD (320 x 240 pixels) or TFT LCD	Backlit monochrome or color STN LCD or backlit color TFT LCD (320 x 240 pixels)	Backlit color STN LCD or color TFT LCD (640 x 480 pixels)
		3.8" (monochrome or color)	5.7" (monochrome or color)	7.5" (color)
Data entry		Via touch screen		
	Static function keys	–		
	Dynamic function keys	–		
	Service keys	–		
	Alphanumeric keys	–		
Memory capacity		32 MB Flash EPROM	16 MB Flash EPROM	32 MB Flash EPROM
	Application	–	By 128, 256, 512 MB or 1 GB CF card (except XBT GT2110)	
	Expansion			
Functions		Limited by internal Flash EPROM memory capacity	Limited by the internal Flash EPROM memory capacity or CF card memory capacity	
	Maximum number of pages	Unlimited (8000 variables max.)		
	Variables per page	Alphanumeric, bitmap, bargraph, gauge, tank, tank level indicator, curves, polygon, button, light		
	Reintroduction of variables	32 groups of 64 recipes comprised of 1024 ingredients max.		
	Recipes	Yes, with log		
	Curves	Yes		
	Alarm logs	Built-in		
	Real-time clock	–	1 input (reset) and 3 outputs (alarm, buzzer, run)	
	Discrete I/O	–	1 audio input (microphone), 1 composite video input (digital or analog video camera), 1 audio output (loudspeaker) (1)	
	Multimedia I/O			
Communication		Uni-TE™ (2), Modbus®, Modbus® TCP/IP (1) and for PLC brands: Mitsubishi, Omron, Allen-Bradley and Siemens		
	Downloadable protocols	RS 232C/485 (COM1)	RS 232C/RS 422/485 (COM1) and RS 485 (COM2)	
	Asynchronous serial link	1	1	2
	USB ports	–	Modbus Plus™ and Fipway® with USB gateway, Profibus DP™ and Device Net™ with optional card	
	Bus and networks	Ethernet TCP/IP (10BASE-T/100BASE-TX) (1)		
	Printer link	USB port for parallel printer	RS 232C (COM1) serial link, USB port for parallel printer	
Design software		Vijec® Designer™ (on Windows 2000®, Windows XP® and Vista®)		
Operating system		Magelis® (100 MHz RISC CPU) or (200 MHz RISC CPU)	Magelis® (133 MHz RISC CPU)	Magelis® (266 MHz RISC CPU)
Type of terminal		XBT GT11/13	XBT GT21/22/23	XBT GT42/43
Pages		Consult our "Human/Machine Interfaces" catalog		

(1) Depending on model
(2) Uni-TE™ version V2 for Twido® controller and TSX Micro™/Premium™ platform.



Touch screen Advanced Panels	Advanced Panels with keypad/ touch screen	Touch screen/open Advanced Panels
------------------------------	--	-----------------------------------



Backlit color STN LCD or color TFT LCD (640 x 480 pixels)	Backlit color TFT LCD (800 x 600 pixels)	Backlit color TFT LCD (1024 x 768 pixels)	Color TFT LCD (320 x 240 pixels) or monochrome STN	Color TFT LCD (640 x 480 pixels)	Color TFT LCD (800 x 600 pixels)	Color TFT LCD (1024 x 768 pixels)
10.4" (color)	12.1" (color)	15" (color)	5.7" (monochrome or color)	10.4" (color)	8.4" (color)	15" (color)

Via touch screen	Via keypad and/or touch screen (configurable) and/or by industrial pointer		Via touch screen
-	10	12	-
-	14	18	-
-	8		-
-	12		-

32 MB Flash EPROM	16 MB Flash EPROM	32 MB Flash EPROM	Limited by 1 GB CF system
By 128, 256, 512 MB or 1 GB CF card			

Limited by the internal Flash EPROM memory capacity or CF card memory capacity

Unlimited (8000 variables max.)

Alphanumeric, bitmap, bargraph, gauge, tank, tank level indicator, curves, polygon, button, light

32 groups of 64 recipes comprised of 1024 ingredients max.

Yes, with log

Yes

Built-in

1 input (reset) and 3 outputs (alarm, buzzer, run)	-	1 input - 3 outputs	-
--	---	---------------------	---

1 audio input (microphone), 1 composite video input (digital or analog video camera), 1 audio output (loudspeaker) (1)	-		1 audio output
--	---	--	----------------

Uni-TE™ (2), Modbus®, Modbus® TCP/IP (1) and for PLC brands: Mitsubishi, Omron, Allen-Bradley and Siemens

RS 232C/RS 422/485 (COM1) and RS 485 (COM2)	RS 232C/RS 422/485 (COM1) RS 485 (COM2)	RS 232C (COM1) RS 232C (COM2)
2	1	2
		4

Modbus Plus™ and Fipway® with USB gateway, Profibus DP™ and Device Net™ with optional card	4 + 1 on front
	Modbus Plus™ with USB gateway

Ethernet TCP/IP (10BASE-T/100BASE-TX)	1 Ethernet TCP/IP port (10BASE-T/100BASE-TX) and 1 Ethernet port (10BASE-T/100BASE-TX/1 GB)
---------------------------------------	---

RS 232C (COM1) serial link, USB port for parallel printer

Vijeo® Designer™ (on Windows 2000® and Windows XP®)	Vijeo® Designer™ (Windows 2000®, Windows XP® and Vista®)
---	--

Magelis® (266 MHz RISC CPU)	Windows XP® embedded
-----------------------------	----------------------

XBT GT52/53	XBT GT63	XBT GT73	XBT GK 21/23	XBT GK 53	XBT GTW 450	XBT GTW 750
--------------------	-----------------	-----------------	---------------------	------------------	--------------------	--------------------

Consult our "Human/Machine Interfaces" catalog

Modicon® M340™ automation platform

Operator dialog terminals

HMI software

Applications

Traditional architecture, HMI executed on PC platform or dedicated terminal

Configuration software for operator dialog applications

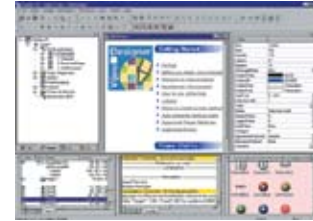

Target products Type

Operating system on terminals

Magelis® XBT N (1)
Magelis XBT R/RT (1)

Proprietary Magelis

Magelis XBT G (1)
Magelis XBT GT (1)
Magelis XBT GK (1)
Magelis XBT GTW (1)

Excluding Magelis XBT GTW: Windows XP® embedded

Functions

Reading/writing of PLC variables

Display of variables

Data processing

Sharing of variables between HMI applications

Saving of variables to external database

Yes

Yes

– Yes, using expression editor or Java programming

–

–

Development of graphics applications

Native library of graphic objects

Container Microsoft® ActiveX®
Java Beans

Curves and alarms

Scripts

Yes

–

– Yes

Yes (2) Yes, with log

– Java

Online modification of applications

–

Communication between PLCs and HMI application

Via I/O drivers

Uploading of applications

Yes

Simulation of HMI applications

Yes

Redundancy

–

Recipe management

No Yes

Report printing

– On the fly alarms, log data

Access security

Linked to user profiles

Software compatible with OS

Windows 2000® or Windows XP®

Windows 2000® , Windows XP® or Windows Vista®

Type of software

Vijeo® Designer™ Lite

Vijeo® Designer™



Page(s)

Consult our "Human/Machine Interfaces" catalog

(1) Magelis® terminals XBT behave transparently on restoration of power.
(2) Depending on model.

SCADA supervisory software

Data logging/reporting software

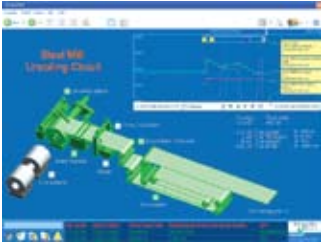

Magelis® Compact iPC industrial PCs
Magelis Modular iPC industrial PCs
PC micro-computers

Magelis Compact iPC industrial PCs
Magelis Modular iPC industrial PCs
PC micro-computers
Servers

Magelis Compact iPC industrial PCs
Magelis Modular iPC industrial PCs
PC micro-computers
Servers

Microsoft Windows®

Microsoft Windows

Yes

No

Yes

Yes

Yes

Yes

Yes
Client/Server architecture

–

Yes

–

Yes

No

Yes

–

–

–

Yes, with log

–

C compiler integrated

–

Yes (version 7.0 upwards)

–

Via OFS data drivers

–

No

–

–

–

Yes

–

Yes

–

Information in the real-time data base

–

–

Linked to user profile

Linked to user profile

Windows XP®, Servers

Windows XP®, Servers

Vijeo® Citect® Lite

Vijeo® Citect®

Vijeo Historian™



4/55

See the website www.schneider-electric.us/

6.1 - Technical information

- Standards and certifications 6/2
- Automation products certifications and community regulations. 6/6
- CANopen data sheet 6/8
- Compatibility between discrete input modules
and inductive proximity sensors 6/10
- Compatibility between discrete input modules
and photo-electric sensors 6/12
- Power consumption table 6/13

6.2 - Index

- Product reference index 6/14

Standards and certifications

Modicon® M340™ PLCs have been developed to conform to the principal national and international standards concerning electronic equipment for industrial automation systems.

- Requirements specific to programmable controllers: functional specifications, immunity, resistance, etc.: IEC/EN 61131-2, CSA 22.2 N° 142, UL 508.
- Merchant navy requirements of the main international bodies (with ABS, BV, DNV, GL, LR, RINA, RMRS): IACS (*International Association of Classification Societies*).
- Compliance with European Directives:
 - Low Voltage: 73/23/EEC amendment 93/68/EEC,
 - Electromagnetic Compatibility: 89/336/EEC amendments 92/31/EEC and 93/68/EEC.
- Electrical qualities and self-extinguishing capacity of insulating materials: UL 746C, UL 94.
- Hazardous areas classification: CSA 22.2 No. 213, Class I, Division 2, Groups A, B, C and D.

Specifications

Service conditions and recommendations relating to environment

Temperature	Operation	°C	0...+ 60			
	Storage	°C	- 40...+ 85			
Relative humidity	Operation	%	93...95 without condensation according to IEC/EN 60068-2-30 Db			
	Storage	%	93...95 without condensation according to IEC/EN 60068-2-30 Db			
Altitude		m	0...4000, temperature derating from 3000 m: 1°C / 400 m, equals to + 55°C at 4000 m			
Supply voltage ~: according to IEC/EN 61131-2 ---: according to IACS E10 battery without charge	Nominal voltage	V	BMX CPS 2010	BMX CPS 3020	BMX CPS 2000	BMX CPS 3500
	Limit voltages		--- 24	--- 24...48	~ 100...240	~ 100...240
	Nominal frequencies	Hz	--- 18...31.2	--- 18...62.4	~ 85...264	~ 85...264
	Limit frequencies	Hz	–	–	50/60	50/60
					47/63	47/63

Protective treatment of Modicon® Premium™ PLCs

Modicon M340 PLCs meet the requirements of "TC" treatment (*Treatment for all Climates*).

For installations in industrial production workshops or environments corresponding to "TH" treatment (*treatment for hot and humid environments*), Modicon M340 PLCs must be embedded in envelopes with a minimum IP 54 protection, in compliance with IEC/EN 60664 and NF C 20 040.

Modicon M340 PLCs themselves offer **protection to IP 20 level** and **protection against pins** (enclosed equipment) (1). They can therefore be installed without an envelope in reserved-access areas that do not exceed **pollution level 2** (control room with no dust-producing machine or activity). The pollution level 2 does not take account of more severe environmental conditions: air pollution by dust, smoke, corrosive or radioactive particles, vapors or salts, attack by fungi, insects, etc.

(1) In the case where a position is not occupied by a module, a **BMX XEM 010** protection cover must be installed.

Environment tests		
Name of test	Standards	Levels
Immunity to LF interference (CE) (1)		
Voltage and frequency variation	IEC/EN 61000-4-11 IACS E10 / IEC 60092-504	0.85 Un/0.95 Fn for 30 minutes; 1.10 Un/1.05 Fn for 30 minutes; 0.8 Un/0.9 Fn for 1,5/5 seconds; 1.2 Un/1.1 Fn for 1,5/5 seconds
Direct voltage variation	IEC/EN 61131-2 IEC/EN 61000-4-11 IEC 60092-504 IACS E10 (battery without charge)	0.85 Un...1.2 Un for 30 minutes with 5% ripple (peak values)
Harmonic 3	IEC/EN 61131-2	10% Un; 0° for 5 min...180° for 5 min
Inter harmonic	IACS E10 / IEC 60092-504	H2...H200 - 10% (H15), - 10%...1% (H15...H100) and 1% (H100...H200)
Short momentary interrupt	IEC/EN 61131-2 IEC/EN 61000-4-11/-6-2	10 ms with ~ supply; 1 ms with --- supply
Voltage shut-down/start-up	IEC/EN 61131-2	Un-0-Un; Un for 60 s; 3 cycles separated by 10 s Un-0-Un; Un for 5 s; 3 cycles separated by 1 to 5 s Un-0.9-Udl; Un for 60 s; 3 cycles separated by 1 to 5 s

Where:
Un: nominal voltage
Fn: nominal frequency
Udl: detection level when powered

Name of test	Standards	Levels
Immunity to HF interference. (CE) (1)		
Damped oscillatory wave	IEC/EN 61000-4-12 IEC/EN 61131-2 Zone C	~ / --- main supply, ~ auxiliary supply, discrete ~ I/O (unshielded): 2.5 kV in common mode, 1 kV in differential mode --- auxiliary supply, discrete ~ I/O (unshielded) and analog I/O: 1 kV in common mode, 0.5 kV in differential mode Shielded cable: 0.5 kV in common mode
Electrical fast transient bursts	IEC/EN 61000-4-4 IEC 61131-2 / IACS E10	~ / --- main and auxiliary supplies, discrete ~ I/O (unshielded): 2 kV in wire mode, 2 kV in common mode Discrete --- I/O (unshielded), analog I/O and shielded cable: 1 kV in common mode
Surge	IEC/EN 61000-4-5 IEC/EN 61131-2 Zone B IACS E10	~ / --- main and auxiliary supplies, discrete ~ I/O (unshielded): 2 kV in common mode, 1 kV in differential mode Discrete ~ I/O (unshielded) and analog I/O: 0.5 kV in common mode, 0.5 kV in differential mode Shielded cable: 1 kV in common mode
Electrostatic discharges	IEC/EN 61000-4-2 IEC/EN 61131-2 Zone B IACS E10	6 kV contact, 8 kV air
Radiated electromagnetic field	IEC/EN 61000-4-3	15 V/m: 80 MHz...2 GHz Sinusoidal modulation amplitude 80%/1 kHz + internal clock frequency
Conducted interference induced by radiated field	IEC/EN 61000-4-6 IEC/EN 61131-2 IACS E10	10 V: 0,15 MHz...80 MHz Sinusoidal modulation amplitude 80%/1 kHz + spot frequency
Electromagnetic emissions (CE) (1) (2)		
Interference voltage	EN 55011, Classe A IEC/EN 61131-2 IEC/EN 61000-6-4 FCC part 15 IACS E10	150 kHz...500 kHz quasi-peak 79 dB (µV); average 66 dB (µV) 500 kHz...30 MHz quasi-peak 73 dB (µV); average 60 dB (µV) Values according general power distribution zone
Interference field	EN 55011, Classe A IEC/EN 61131-2 IEC/EN 61000-6-4 FCC part 15 IACS E10	30 MHz...230 MHz: quasi-peak 40 dB (measurement at 10 m), quasi-peak 50 dB (measurement at 3 m) 230 MHz...2 GHz: quasi-peak 47 dB (measurement at 10 m), quasi-peak 57 dB (measurement at 3 m) Values depending on general power distribution zone

(1) Devices must be installed and wired in compliance with the instructions provided in the manual "Grounding and Electromagnetic Compatibility of PLC systems", pdf format on CD-ROM included in Unity Pro/PL7 software or on DVD **UNY USE 909 CD M** (see page 4/39).
(2) These tests are performed without a cabinet, with devices fixed on a metal grid and wired as per the recommendations in the manual "Grounding and Electromagnetic Compatibility of PLC systems".

Note: (CE): tests required by European directives CE. and based on IEC/EN 61131-2 standards.

Environment tests (continued)		
Name of test	Standards	Levels
Immunity to climatic variations		
Dry heat	IEC/EN 60068-2-2 Bd IACS E10	60°C for 16 hours
Cold	IEC/EN 60068-2-1 Ab & Ad IACS E10	0°C for 16 hours with start at 0°C
Continuous humid heat	IEC/EN 60068-2-78 Ca	60°C with 93% relative humidity for 96 hours
Cyclical humid heat	IEC/EN 60068-2-30 Db	55°C, 25°C with 93...95% relative humidity with 2 cycles of 12 hours/12 hours
Cyclical temperature variations	IEC/EN 60068-2-14 Na & Nb IEC/EN 61131-2	0...60°C with 5 cycles of 3 hours/3 hours
Withstand to climatic variations		
Dry heat (power off)	IEC/EN 60068-2-2 Bb & Bd	85°C for 96 hours
Cold (power off)	IEC/EN 60068-2-1 Ab & Ad IEC/EN 60068-2-48	- 40°C for 96 hours
Humid heat (power off)	IEC/EN 60068-2-30 dB	25...60°C with 93...95% relative humidity; 2 cycles: 12 hours/12 hours
Heat shocks (power off)	IEC/EN 60068-2-14 Na & Nb	- 40...85°C with 2 cycles of 3 hours/3 hours

Environment tests (continued)		
Name of test	Standards	Levels
Immunity to mechanical constraints (1) (power on)		
Sinusoidal vibrations	IEC/EN 60068-2-6 Fc IACS E10	3 Hz...100 Hz/1 mm amplitude / 0.7 g, transition frequency 13.2 Hz Endurance to resonance frequency 90 min/axis Application coefficient < 10
Sinusoidal vibrations (Class 3M7)	IEC/EN 60068-2-6 Fc IEC/EN 61131-2 Specific profil	5...150 Hz with 10 mm amplitude / 3 g, transition frequency 9 Hz Endurance: 10 cycles of 1 octave/min
Shocks	IEC/EN 60068-2-27 Ea	30 g - 11 ms; 3 shocks/direction/axis (2)
Bumps	IEC/EN 60068-2-29 Eb	25 g - 6 ms; 100 bumps/direction/axis (3)
Plugging / unplugging	IEC/EN 61131-2	For modules and connectors 50 operations for permanent connections 500 operations for non permanent connections
Withstand to mechanical constraints (power off)		
Flat freefall	IEC/EN 60068-2-32 Ed method 1 IEC/EN 61131-2	10 cm/2 falls
Controlled position freefall (for handheld product)	IEC/EN 60068-2-31 Ec IEC/EN 61131-2	30° or 10 cm/2 falls
Random freefall (equipment in packaging)	IEC/EN 60068-2-32 method 1 IEC/EN 61131-2	1 m/5 falls
Vibrations, transports (Class 2M3)	IEC/EN 60721-4-2 IEC/EN 60068-2-64 Fh	Stationary vibrations, random: 5 m ² /s ³ from 10...100 Hz, 7 dB/octave from 100...200 Hz, 1 m ² /s ³ from 200...2000 Hz, 30 min duration per axe
Operating specifications (1) (CE)		
Dielectric strength	UL 508/CSA 22-2 No.142 / FM IEC/EN 61131-2	2 Un + 1000 V / 1 min
Insulation resistance	UL 508/CSA 22-2 No.142 / FM IEC/EN 61131-2	Un ≤ 50 V: 10 MΩ 50 V ≤ Un ≤ 250 V: 10 MΩ
Continuity of earth ground	UL 508/CSA 22-2 No.142 / FM IEC/EN 61131-2	30 A for 2 min, R < 0,1 Ω
Leakage current	IEC/EN 61131-2	I < 3.5 mA after disconnecting
Protection offered by enclosures	IEC/EN 61131-2	IP 20 and protection against standardize pins
Withstand to impacts	UL 508/CSA 22-2 No.142 / FM IEC/EN 61131-2	500 g sphere: fall from 1.3 m
Stored energy injury risk	IEC/EN 61131-2	After 10 s, max. 37% Un
Overload	UL 508/CSA 22-2 No.142 / FM IEC/EN 61131-2	50 cycles 1 s / 9 s to Un and 1.5 In
Endurance	UL 508/CSA 22-2 No.142 / FM IEC/EN 61131-2	12 cycles 100 ms / 100 ms, 988 cycles 1 s / 1 s and 5000 cycles 1 s / 9 s to Un and In
Temperature rise	IEC/EN 61131-2/UL 508 CSA 22-2 No.142/UL 1604 CSA 22-2 No.213 / FM	Ambient temperature 60°C

(1) Devices must be installed, wired and maintained in compliance with the instructions provided in the manual "Grounding and Electromagnetic Compatibility of PLC Systems".

(2) Fast actuators (response time ≤ 15 ms) driven by relay outputs: 15 g - 11 ms; 3 shocks/direction/axis

(3) Fast actuators (response time ≤ 15 ms) driven by relay outputs: 15 g - 6 ms; 100 bumps/direction/axis.

Note: (CE): tests required by European directives CE. and based on IEC/EN 61131-2 standards.

Technical information









Automation products certifications

In some countries, certification of certain electrical components is enforced by law. A standard conformity certificate is then issued by the official organization. Each certified product must carry approval symbols when enforced. Use on board merchant navy vessels generally requires prior approval (= certification) of an electrical device by certain marine classification authorities.

Key	Certification body	Country
CSA	Canadian Standards Association	Canada
C-Tick	Australian Communication Authority	Australia, New Zealand
GOST	Scientific research institute for GOST standards	CIS, Russia
UL	Underwriters Laboratories	USA
Key	Classification society	Country
IACS	International Association of Classification Societies	International
ABS	American Bureau of Shipping	USA
BV	Bureau Veritas	France
DNV	Det Norske Veritas	Norway
GL	Germanischer Lloyd	Germany
LR	Lloyd's Register	UK
RINA	Registro Italiano Navale	Italy
RMRS	Russian Maritime Register of Shipping	CIS, Russia
RRR	Russian River Register	

The table below shows the certifications obtained or pending from organizations for base PLCs as of 01/08/2008. An overview of certificates for Schneider Electric products is available on our website: www.schneider-electric.us/

Product certifications

	Certifications						
	 UL USA	 CSA Canada	 ACA Australia	 GOST CIS, Russia	 Hazardous locations Class I, div 2 (1)	 ATEX Europe	 TÜV Rheinland
 <i>Certified</i>							
 <i>Certification pending</i>							
Advantys™ OTB							
Advantys™ STB					FM	Cat. 3 G	
Advantys™ Telefast® ABE 7							
ConneXium™					(2)		
Magelis iPC™, Magelis® XBT GTW (3)					UL		
Magelis® XBT GT					CSA/UL	Cat. 3 G-D	
Magelis® XBT GK							
Magelis® XBT F/FC/HM/PM							
Magelis® XBT N/R					CSA/UL	Cat. 3 G-D	
Magelis® XBT RT					CSA/UL	Cat. 3 G-D	
Modicon® M340™					CSA		
Modicon® Momentum™							
Modicon® Premium™				(2)	CSA		
Modicon® Quantum™				(2)	FM (2)		
Modicon® Quantum Safety™				(2)	CSA		SIL3 (4)
Modicon® TSX Micro™							
Phaseo®	(3) (5)						
Twido®	(6)	(6)			CSA/UL (6)		

(1) Hazardous locations: UL 1604, CSA 22.2 no. 213 or FM 3611, certified products are acceptable for use in hazardous locations of Class I, division 2, groups A, B, C and D or unclassified only.

(2) Depends on the product. Please visit our website: www.schneider-electric.us/

(3) cULus North American certification (Canada and USA)

(4) Certified for use in applications up to and including SIL3 according to IEC 61508.

(5) Except Universal power supplies and Function modules: UL certification pending.

(6) Except TWD NOI 10M3 AS-Interface module, only CC.

Local certifications

BG	Germany	Safety module TSX DPZ 10D2A (Modicon TSX Micro) Safety modules TSX PAY 262/282 (Modicon Premium)
SIMTARS	Australia	Modicon TSX Micro automation platform Modicon Premium (PL7) automation platform
AS-Interface	Europe	Master module TWD NOI 10M3 (Twido) Master module TSX SAZ 10 (Modicon TSX Micro) Master modules TSX SAY 1000 (Modicon Premium)







Note: All marks are property of their respective owners.

Technical information

Automation products certifications

Community regulations

Marine certification

	Marine classification authorities						
							
	ABS	BV	DNV	GL	LR	RINA	RMRS
	USA	France	Norway	Germany	UK	Italy	C.I.S.
Advantys™ OTB							
Advantys™ STB	(1)						
Advantys™ Telefast® ABE 7							
ConneXium™				(2)			
Magelis® iPC™							
Magelis® iPC™, Magelis® XBT GTW	(2)	(2)	(2)	(2)	(2)	(2)	
Magelis® XBT GK							
Magelis® XBT F/FC/HM/PM							
Magelis® XBT N/R		(2)	(2)	(2)		(2)	
Magelis® XBT RT							
Modicon® M340™							
Modicon® Momentum™							
Modicon® Premium™ (3)	(2)	(2)	(2)	(2)	(2)	(2)	(2)
Modicon® Quantum™	(2)	(2)	(2)	(2)	(2)	(2)	(2)
Modicon® TSX Micro™							
Phaseo®							
Twido®			(4)	(4)	(4)		

(1) Also covers US Navy requirements **ABS-NRV** part 4.

(2) Depends on the product. Please visit our website: www.schneider-electric.us.

(3) Modicon Premium, also **KRS** (Korean Register of Shipping) certified.

(4) Except: compact bases **TWD LC●●40DRF**, Extreme base **TWD LEDCK1**, I/O module **TWD DAI 8DT**, analog I/O modules **TWD AMI 2LT/4LT/8HT**, **TWD ARI 8HT**, **TWD AVO 2HT**, **TWD AMM 6HT**, communication modules **499 TWD 01100**, **TWD NCO1M**, **TWD NOI 10M3** and taps **TWD XCA ISO/T3RJ**.

EC regulations

European Directives

The opening of European markets implies a harmonization of regulations in the various European Union member states.

European Directives are documents used to remove obstacles to the free movement of goods and their application is compulsory in the European Union.

Member states are obliged to transcribe each Directive into their national legislation and, at the same time, to withdraw any conflicting regulations.

The Directives, particularly those of a technical nature, only set objectives, called "general requirements".

The manufacturer must take the necessary measures to help ensure that his products conform to the requirements of each Directive relating to his equipment.

As a general rule, the manufacturer affirms that his product conforms to the necessary requirements of the Directive(s) by applying the CE label to his product.

The CE marking is applied to Schneider Electric products where relevant.

The significance of CE marking

■ The CE marking on a product indicates the manufacturer certifies that his product conforms to the relevant European Directives. This is necessary so that a product that is subject to a Directive can be marketed and freely moved within the European Union.

■ The CE marking is intended solely for the national authorities responsible for market regulation.

For electrical equipment, conformity of the product to standards indicates that it is suitable for use.

One or more Directives, as appropriate, may apply to our products, in particular:

- The Low Voltage Directive 2006/95/EC.
- The Electromagnetic Compatibility Directive 89/336/EEC, amended by Directives 2004/108/EC.
- Directive CE ATEX 94/9/EC.

Note: All marks are property of their respective owners.

Family	Products	Function	Nb of products	PDO Process Data Objects			
				Tx max. (1)		Rx max. (1)	
Motor control							
TeSys® Quickfit®	APP 1CCO0			1 (5)		1 (5)	
	APP 1CCO2			1 (5)		1 (5)	
TeSys® T Management system	Local MMC_L			2 (4)		2 (4)	
	Local MMC_L_EV40			2 (4)		2 (4)	
	A distance MMC_R			2 (4)		2 (4)	
	A distance MMC_R_EV40			2 (4)		2 (4)	
TeSys® U Starter-controller	C_Ad			2 (4)		2 (4)	
	C_Mu_L			2 (4)		2 (4)	
	C_Mu_R			2 (4)		2 (4)	
	Sc_Ad			2 (4)		2 (4)	
	Sc_Mu_L			2 (4)		2 (4)	
	Sc_Mu_R			2 (4)		2 (4)	
	Sc_St			2 (4)		2 (4)	
Detection							
Osicodur	Encoders Ø 58 mm			1 (2)			
Distributed I/O							
Advantys™ FTB monobloc	FTB 1CN08E08CM0			1 (2)		1 (2)	
	FTB 1CN08E08SP0			1 (2)		1 (2)	
	FTB 1CN12E04SP0			1 (2)		1 (2)	
	FTB 1CN16CM0			1 (2)		1 (2)	
	FTB 1CN16CP0			1 (2)		1 (2)	
	FTB 1CN16EM0			1 (2)			
	FTB 1CN16EP0			1 (2)			
Advantys™ FTM modular	FTM 1CN10			3 (5)		3 (5)	
Advantys™ OTB	Station (with expansion modules)	Standard		3 (8)		2 (8)	
		Extended		6 (8)		3 (8)	
	OTB 1C0 DM9LP	Interface		1 (8)		1 (8)	
Advantys™ STB	STB NCO 1010 (NIM Basic range module)	Simple		6 (32)		4 (32)	
		Extended		10 (32)		8 (32)	
	STB NCO 2212 (2) (NIM Standard range module)	Simple		6 (32)		4 (32)	
		Extended		10 (32)		8 (32)	
		Advanced		12 (32)		10 (32)	
		Large		28 (32)		20 (32)	
Motion and Drives							
Altivar® 31	ATV31_V1_1	Basic		1 (2)		1 (2)	
		Standard		1 (2)		1 (2)	
		Extended		1 (2)		1 (2)	
	ATV31_V1_2	Basic		1 (2)		1 (2)	
		Standard		1 (2)		1 (2)	
		Extended		1 (2)		1 (2)	
	ATV31_V1_7	MFB Motion		1 (2)		1 (2)	
		Basic		1 (2)		1 (2)	
		Standard		1 (2)		1 (2)	
	ATV31_V1_3	Extended		1 (2)		1 (2)	
		Basic		1 (2)		1 (2)	
		Standard		1 (2)		1 (2)	
Altivar® 61	ATV61_V1_1	Extended		1 (2)		1 (2)	
		Basic		1 (3)		1 (3)	
		Standard		1 (3)		1 (3)	
		Controller		1 (3)		1 (3)	
Altivar® 71	ATV71_V1_1	Basic		1 (3)		1 (3)	
		Standard		1 (3)		1 (3)	
		Extended		1 (3)		1 (3)	
		Controller		1 (3)			
		MFB Motion		1 (3)		1 (3)	
IclA, Intelligent Compact Drive	IclA_IFA, IclA_IFE, IclA_IFS	Défaut		1 (1)		1 (1)	
		MFB Motion		1 (1)		1 (1)	
Lexium® Servo drive	Lexium 05_MFB			2 (4)		1 (4)	
	Lexium 05 ≥ 1.12			1 (4)		1 (4)	
	Lexium 15 LP ≥ 1.45			2 (4)		3 (4)	
	Lexium 15 MD/HP ≥ 6.64	Default			1 (4)		1 (4)
		MFB Motion			2 (4)		3 (4)
	SD3_28			1 (4)		1 (4)	
Safety controllers							
Preventa™	XPS MC16ZC			1 (4)			
	XPS MC32ZC			1 (4)			
Partner products							
Festo	CPV_C02 Valves	Basic		1 (1)		1 (1)	
		Advanced		1 (1)		1 (1)	
		CP Extended		1 (1)		1 (1)	
	CPX_FB14 Valves	Basic_DIO_Only			2 (4)		2 (4)
		Generic_DIO_AIO			2 (4)		2 (4)
Parker	P2M2HBVC11600	Valves		4 (4)		4 (4)	
				1 (1)		1 (1)	

6

Procedure: Verify column by column (or for %Mi and %MWi, by group of column) that: $\Sigma (\text{objects} \times \text{nb of products}) \leq \text{Max. capacity}$

Bus total			
Max. capacity	≤ 63	≤ 252	≤ 252

(1) The first value applies to the typical value, the 2nd to the max. value.

(2) The use of Advantys STB SPU 1●●● configuration software allows to optimize the memory mapping, thus decrease the memory occupation.

Max. Tx	Cob Id		Max. Extra	Internal bits%Mi		Internal words%MWi		Products
	Max. Rx			Max. inputs	Max. outputs	Max. inputs	Max. outputs	
1	1			4	2			APP 1CCO0
1	1			8	6			APP 1CCO2
2	2			46	8			MMC_L
2	2			62	12			MMC_L_EV40
2	2			46	8			MMC_R
2	2			62	12			MMC_R_EV40
2	2			16	8			C_Ad
2	2			50	10			C_Mu_L
2	2			38	12			C_Mu_R
2	2			14	10			Sc_Ad
2	2			48	10			Sc_Mu_L
2	2			36	12			Sc_Mu_R
2	2			14	10			Sc_St

Encoder Ø 58 mm								
1				2				
1	1			2		40	8	FTB 1CN08E08CM0
1	1			2			8	FTB 1CN08E08SP0
1	1			2		28	4	FTB 1CN12E04SP0
1	1			2		56	16	FTB 1CN16CM0
1	1			2		56	16	FTB 1CN16CP0
1	4			2		24		FTB 1CN16EM0
1	4			2		24		FTB 1CN16EP0
3	3			54	50			FTM 1CN10
3	2			68	20			OTB ilôt stand.
4	3	2		102	54			OTB ilôt extend.
1	1			38	10			OTB 1C0 DM9LP
4	4	2		132	96			STB NCO 1010 St.
4	4	10		228	192			STB NCO 1010 Et.
4	4	2		132	96			STB NCO 2212 St.
4	4	10		228	192			STB NCO 2212 Et.
4	4	14		278	244			STB NCO 2212 Av.
4	4	40		694	484			STB NCO 2212 Lg.

1	1			4	4			ATV31_V1_1 Bas.
1	1			6	10			ATV31_V1_1 St.
1	1			20	16			ATV31_V1_1 Ext.
1	1			4	4			ATV31_V1_2 Bas.
1	1			6	10			ATV31_V1_2 St.
1	1			20	16			ATV31_V1_2 Ext.
1	1			2	2			ATV31_V1_2 MFB
1	1			4	4			ATV31_V1_7 Bas.
1	1			6	10			ATV31_V1_7 St.
1	1			20	16			ATV31_V1_7 Ext.
1	1			4	4			ATV31_V1_3 Bas.
1	1			6	10			ATV31_V1_3 St.
1	1			20	16			ATV31_V1_3 Ext.
1	1			8	8			ATV61_V1_1 Bas.
1	1			32	20			ATV61_V1_1 St.
1	1			70	62			ATV61_V1_1 Et.
1	1			76	62			ATV61_V1_1 Co.
1	1			8	8			ATV71_V1_1 Bas.
1	1			16	10			ATV71_V1_1 St.
1	1			22	14			ATV71_V1_1 Ext.
1	1			80	58			ATV71_V1_1 Co.
1	1			6	6			ATV71_V1_1 MFB
1	1			8	10			IclA_IF Default
1	1			6	6			IclA_IF MFB
2	1			10	10			Lexium 05_MFB
1	1			24	26			Lexium 05
2	3			8	10			Lexium 15 LP
1	1			96	134			Lex.15 MD/HP Def.
2	3			8	10			Lex.15 MD/HP MFB.
1	1			22	20			SD3_28

1				28				XPS MC16ZC
1				28				XPS MC32ZC

1	1			8	4			CPV_C02 Basic
1	1			10	6			CPV_C02 Advan.
1	1			10	4			CPV_C02 Extend.
2	2			56	50			CPX_FB14 Basic
2	2			26	20			CPX_FB14 Gener.
4	4			72	66			CPX_FB14 Advan.
1	1			2	2			P2M2HBVC11600



Modicon® M340™ automation platform

Discrete inputs modules and
inductive proximity sensors

Inductive proximity sensors				Inputs, BMX DDI				Inputs, BMX DDM			Inputs, BMX DAI		
				1602	1603	3202K	6402K	16022	16025	3202K	1602	1603	1604
Osiprox® Universal													
Cylindrical, flush mountable, standard sensing distance	Ø 8, threaded M8 x 50	3-w, PNP	XS6 08B1P●●●●										
	Ø12, threaded M12 x 50	3-w, PNP	XS6 12B1P●●●●										
	Ø18, threaded M18 x 60	3-w, PNP	XS6 18B1P●●●●										
	Ø30, threaded M30 x 60	3-w, PNP	XS6 30B1P●●●●										
Cylindrical, non flush mountable, increase sensing distance	Ø12, threaded M12 x 55	3-w, PNP	XS6 12B4P●●●●										
	Ø18, threaded M18 x 60	3-w, NPN	XS6 12B4N●●●●										
		3-w, PNP	XS6 18B4P●●●●										
	3-w, NPN	XS6 18B4N●●●●											
Ø30, threaded M30 x 62,5	3-w, PNP	XS6 30B4P●●●●											
	3-w, NPN	XS6 30B4N●●●●											
	Osiconcept™, flat, flush mountable and non flush mountable												
	Form E, 26 x 26 x 13	3-w, PNP	XS8 E1A1P●●●										
3-w, NPN		XS8 E1A1N●●●											
Form C, 40 x 40 x 15	3-w, PNP	XS8 C1A1P●●●											
	3-w, NPN	XS8 C1A1N●●●											
Form D, 80 x 80 x 26	3-w, PNP	XS8 D1A1P●●●											
	3-w, NPN	XS8 D1A1N●●●											
Osiconcept™, flush mountable and non flush mountable	Ø12, threaded M12 x 54,6	3-w, PNP	XS6 12B2P●L01M12										
		3-w, NPN	XS6 12B2N●L01M12										
	Ø18, threaded M18 x 60	3-w, PNP	XS6 18B2P●L01M12										
		3-w, NPN	XS6 18B2N●L01M12										
Ø30, threaded M30 x 62,6	3-w, PNP	XS6 30B2P●L01M12											
	3-w, NPN	XS6 30B2N●L01M12											
Osiprox® Optimum													
Cylindrical, flush mountable, sensing distance standard	Ø8, threaded M8 x 33	3-w, PNP	XS5 08B1P●●●										
		3-w, NPN	XS5 08B1N●●●										
	Ø8, threaded M8 x 50	2-wire	XS5 08B1D/C●●●										
		3-w, PNP	XS5 12B1P●●●										
	Ø12, threaded M12 x 35	3-w, NPN	XS5 12B1N●●●										
		2-wire	XS5 12B1D/C●●●										
	Ø18, threaded M18 x 38	3-w, PNP	XS5 18B1P●●●										
		3-w, NPN	XS5 18B1N●●●										
	Ø18, thread. M18 x 52,5	2-wire	XS5 18B1D/C●●●										
		3-w, PNP	XS5 30B1P●●●										
Ø30, threaded M30 x 42,3	3-w, NPN	XS5 30B1N●●●											
	2-wire	XS5 30B1D/C●●●											
Cylindrical, flush mountable, increase sensing distance	Ø6, plain 6 x 33	3-w, PNP	XS1 L06P●349●										
		3-w, NPN	XS1 L06N●349●										
	Ø8, threaded M8 x 33	3-w, PNP	XS1 L08P●349●										
		3-w, NPN	XS1 L08N●349●										
	Ø12, threaded M12 x 35	3-w, PNP	XS1 L12P●349●										
		3-w, NPN	XS1 L12N●349●										
	Ø18, threaded M18 x 38	3-w, PNP	XS1 L18P●349●										
		3-w, NPN	XS1 L18N●349●										
	Ø30, threaded M30 x 42,3	3-w, PNP	XS1 L30P●349●										
		3-w, NPN	XS1 L30N●349●										
Flat, flush mountable	Form J, 8 x 22 x 8	3-w, PNP	XS7 J1A1P●●●										
		3-w, NPN	XS7 J1A1N●●●										
	Form F, 15 x 32 x 8	2-wire	XS7 J1A1D●●●										
		3-w, PNP	XS7 J1A1P●●●										
	3-w, NPN	XS7 J1A1N●●●											
		2-wire	XS7 J1A1D●●●										
	Form E, 26 x 26 x 13	3-w, PNP	XS7 E1A1P●●●										
		3-w, NPN	XS7 E1A1N●●●										
		2-wire	XS7 E1A1D●●●										
	Form C, 40 x 40 x 15	3-w, PNP	XS7 C1A1P●●●										
		3-w, NPN	XS7 C1A1N●●●										
		2-wire	XS7 C1A1D●●●										
	Form D, 80 x 80 x 26	3-w, PNP	XS7 D1A1P●●●										
		3-w, NPN	XS7 D1A1N●●●										
		2-wire	XS7 D1A1D●●●										
	Osiprox® Technology												
Cylindrical, plastic, non flush mountable	Ø8, threaded M8 x 33	3-w, PNP	XS4 P08P●340										
		3-w, NPN	XS4 P08N●340										
	Ø12, threaded M12 x 33	3-w, PNP	XS4 P12P●340										
		3-w, NPN	XS4 P12N●340										
	Ø18, threaded M18 x 33,5	3-w, PNP	XS4 P18P●340										
		3-w, NPN	XS4 P18N●340										
	Ø30, threaded M30 x 40,5	3-w, PNP	XS4 P30P●340										
		3-w, NPN	XS4 P30N●340										
		3-w, PNP	XS4 P30P●370										
		3-w, NPN	XS4 P30N●370										

Compatibility

Modicon® M340™ automation platform

Discrete inputs modules and
inductive proximity sensors

Inductive proximity sensors				Inputs, BMX DDI				Inputs, BMX DDM			Inputs, BMX DAI		
				1602	1603	3202K	6402K	16022	16025	3202K	1602	1603	1604
Osiprox® Technology (continued)													
Cylindrical basic, plastic, non flush mountable	Ø8, threaded M8 x 49	3-w, PNP	XS2 08ALP□√2										
		3-w, NPN	XS2 08ALN□√2										
	Ø12, threaded M12 x 49	3-w, PNP	XS2 12ALP●●●										
		3-w, NPN	XS2 12ALN●●●										
	Ø18, threaded M18 x 58,8	3-w, PNP	XS2 18ALP●●●										
		3-w, NPN	XS2 18ALN●●●										
Ø30, threaded M30 x 58,8	3-w, PNP	XS2 30ALP●●●											
	3-w, NPN	XS2 30ALN●●●											
Cylindrical basic, metal, flush mountable and non flush mountable	Ø6, plain 6 x 42	3-w, PNP	XS2 06BLP□√2										
		3-w, NPN	XS2 06BLN□√2										
	Ø8, threaded M8 x 42	3-w, PNP	XS1/XS2 08BLP●●●										
		3-w, NPN	XS1/XS2 08BLN●●●										
	Ø12, threaded M12 x 41,3	3-w, PNP	XS1/XS2 12BLP●●●										
		3-w, NPN	XS1/XS2 12BLN●●●										
Ø18, threaded M18 x 51,3	3-w, PNP	XS1/XS2 18BLP●●●											
	3-w, NPN	XS1/XS2 18BLN●●●											
Miniature brass or stainless steel, flush mountable and non flush mountable	Ø4, plain 4 x 49, NO or NC	3-w, PNP	XS1 L04P●310●/311●										
		3-w, NPN	XS1 L04N●310●/311●										
	Ø5, threaded 4 x 29, NO or NC	3-w, PNP	XS1 N05P●310●/311●										
		3-w, NPN	XS1 N05N●310●/311●										
Ø6,5, plain 6,5 x 33, NO or NC	3-w, PNP	XS1/XS2 L06P●340●											
	3-w, NPN	XS1/XS2 L06N●340●											
Cylindrical, plastic, non flush mountable	Ø12, threaded M12 x 50	4-w, prog.	XS4 P12KP340●										
		4-w, prog.	XS4 P18KP340●										
		4-w, prog.	XS4 P30KP340●										
Cylindrical, metal, flush mountable	Ø12, threaded M12 x 50	4-w, prog.	XS1 M12KP340●										
		4-w, prog.	XS1 M18KP340●										
		4-w, prog.	XS1 M30KP340●										
Cylindrical, metal, non flush mountable	Ø12, threaded M12 x 50	4-w, prog.	XS2 M12KP340●										
		4-w, prog.	XS2 M18KP340●										
		4-w, prog.	XS2 M30KP340●										
Cylindrical, metal, flush mountable and non flush mountable	Ø6,5, plain 6,5 x 50	4-w, PNP	XS1 L06PC410										
		4-w, NPN	XS1 L06NC410										
	Ø8, threaded M8 x 50	4-w, PNP	XS1/XS2 M08PC410●										
		4-w, NPN	XS1/XS2 M08NC410●										
	Ø12, threaded M12 x 33	4-w, PNP	XS1/XS2 N12PC410●										
		4-w, NPN	XS1/XS2 N12NC410●										
Ø18, threaded M18 x 36,5	4-w, PNP	XS1/XS2 N18PC410●											
	4-w, NPN	XS1/XS2 N18NC410●											
Ø30, threaded M30 x 40,6	4-w, PNP	XS1/XS2 N30PC410●											
	4-w, NPN	XS1/XS2 N30NC410●											
Osiprox® Application													
Rotation monitoring	Ø30, threaded M30 x 57	3-w, PNP	XSA V1●373										
Detection at fixed sensing distance fixe, factor 1	Ø18, threaded M18 x 60	4-w, prog.	XS1 M18KPM40●										
		4-w, prog.	XS1 M30KPM40●										
		4-w, prog.	XS7 C40KPM40										
Selective sensors	Ø18, threaded M18 x 60	3-w, PNP	XS1 M18PAS40/20										
Cubic, multi-position stainless steel, non flush mountable, food and beverage serie	Form C, 40 x 40 x 40	2-wire	XS7 T4DA21●●●										
		3-w, PNP	XS2 12SAPA●●										
	Ø12, threaded M12 x 54,5	3-w, NPN	XS2 12SANA●●										
		3-w, PNP	XS2 L2SAPA●●										
	Ø18, plain 18 x 60	3-w, NPN	XS2 L2SANA●●										
		3-w, PNP	XS2 18SAPA●●										
Ø18, threaded M18 x 60	3-w, NPN	XS2 18SANA●●											
	3-w, PNP	XS2 30SAPA●●											
Ø30, threaded M30 x 62,5	3-w, PNP	XS2 30SANA●●											
	3-w, NPN	XS2 30SANA●●											
Plastic, 12 x 26 x 40, for assembly, packaging and light handling	Flush mountable, Sn 2 mm	3-w, PNP	XS7 G12PA140●										
		3-w, NPN	XS7 G12NA140●										
	Non flush mountable, Sn 4 mm	3-w, PNP	XS8 G12PA140●										
		3-w, NPN	XS8 G12NA140●										
	Flush mountable, Sn 2 mm	4-w, PNP	XS7 G12PC440										
		4-w, NPN	XS7 G12NC440										
Non flush mountable, Sn 4 mm	4-w, PNP	XS8 G12PC440											
	4-w, NPN	XS8 G12NC440											
Plastic, plug-in, 5 posit. turret head.	Form C, 40 x 117 x 41 NO + NC	4-w, PNP	XS7/XS8 C40PC44●										
		4-w, NPN	XS7/XS8 C40NC44●										

Compatibility

Modicon® M340™ automation platform

Discrete inputs modules and
photo-electric sensors

Photo-electric sensors				Inputs, BMX DDI				Inputs, BMX DDM			Inputs, BMX DAI		
				1602	1603	3202K	6402K	16022	16025	3202K	1602	1603	1604
Osiris® Universal													
Osiconcept™ Design 18	Ø 18, metal	3-w, PNP	XUB 0BPS●●2										
		3-w, NPN	XUB 0BNS●●2										
	Ø 18, plastic	3-w, PNP	XUB 0APS●●2										
		3-w, NPN	XUB 0ANS●●2										
Osiconcept™ Design	Miniature 12 x 34 x 20	3-w, PNP	XUM 0APSA●●										
		3-w, NPN	XUM 0ANSA●●										
	Compact 18 x 50 x 50	3-w, prog.	XUK 0AKSA●●										
		3-w, prog.	XUX 0AKSA●●										
Teach mode	Fiber optics NO/NC programmable	3-w, PNP	XUD A2PSML2/M8										
		3-w, NPN	XUD A2NSML2/M8										
Osiris® Optimum													
Design 18	Ø 18, threaded, metal	3-w, PNP	XUB 4/5/9/1/2AP●●M12										
		3-w, NPN	XUB 4/5/9/1/2AN●●M12										
	Ø 18, threaded, plastic	3-w, PNP	XUB 4/5/9/1/2BP●●M12										
		3-w, NPN	XUB 4/5/9/1/2BN●●M12										
Design	Miniature 12 x 34 x 20, metal	3-w, PNP	XUM 6/5/9/1/2AP●N●●										
		3-w, NPN	XUM 6/5/9/1/2AN●N●●										
	Miniature 12 x 34 x 20, plastic	3-w, prog.	XUM 5/9/2APCN●										
			XUM 5/9/2ANCN●										
	Compact 18 x 50 x 50	3-w, PNP	XUK 5/9/1/2AP●N●●										
		3-w, NPN	XUK 5/9/1/2AN●N●●										
	Compact 30 x 92 x 77	3-w, PNP	XUX 5/9/1/2AP●N●●										
		3-w, NPN	XUX 5/9/1/2AN●N●●										
	Compact 18 x 70 x 35	3-w, PNP	XUL H08/06/04/70●●●										
		3-w, NPN	XUL J08/06/04/70●●●										
Teach mode	Fiber optics NO/NC programmable	3-w, PNP	XUD A1PSML2/M8										
		3-w, NPN	XUD A1NSML2/M8										
Osiris® Application													
Design miniature	12 x 34 x 20, metal	3-w, PNP	XUM 5/9/2BP●NL2										
Design 18, packaging series	Ø 18, metal	3-w, PNP	XUB TSPS●●2										
		3-w, NPN	XUB TSNS●●2										
	Ø 18, plastic	3-w, PNP	XUB TAPS●●2										
		3-w, NPN	XUB TANS●●2										
	Ø 18, luminesc. sensors	3-w, PNP	XU5 M18U1D										
		3-w, prog.	XUK T1KSM●●										
Design, packaging series	Compact 13 x 47 x 23	4-w, prog.	XUM W1KSNL2										
		4-w, prog.	XUV K0252●●										
	Compact 50 x 50 x 25	3-w, PNP	XUK C1PSMM12										
		3-w, NPN	XUK C1NSMM12										
	Compact 30 x 80 x 57	3-w, PNP	XUR C3PPML2										
		3-w, NPN	XUR C3NPML2										
	Fiber 25 x 92 x 54	3-w, PNP	XUR C4PPML2										
		3-w, NPN	XUR C4NPML2										
	Compact 50 x 50 x 15	3-w, PNP	XUK R1PSMM12										
		3-w, NPN	XUK R1NSMM12										
	Compact 30 x 87 x 63	3-w, prog.	XUV K0955D										
		4-w, prog.	XUR K1KSMM12										
	Compact, luminescence sensors	3-w, prog.	XUR U1KSMM12										
Design, Assembly series	Ø 8, metal	3-w, PNP	XUA H02/05 ●●										
		3-w, NPN	XUA J02/05 ●●										
Frame design	Laser transmission	4-w, PNP	XUY ●●CO929L●SP										
		4-w, prog.	XUV F30/60M8										
	Passageway ≤ 60 mm	4-w, prog.	XUV F120/180/250M12										
		4-w, prog.	XUV F120/180/250M12										
Design, coveyor system & access control series	Diffuse or polarized reflex NO/NC programmable	2-wire, PNP/NPN	XUY P/B 95●S										
Design, Handling series	Ø 18, plastic	3-w, PNP	XU2 P18PP340DL										
		3-w, prog.	XUK 8AKSN●●										
	Compact 18 x 50 x 50	3-w, –	XUY PS1LCO965S										
		3-w, PNP	XUV H0312										
	Fork type 14 x 58 x 68	3-w, NPN	XUV J0312										
		3-w, prog.	XUC 2/9/8AKSA●●										
Design 18, food and beverage series	Ø 18, threaded, stainless steel	3-w, PNP	XUB 0SPS●●2										
		3-w, NPN	XUB 0SNS●●2										
	Compact and fiber	3-w, PNP	XU1/XU2 N18PP341●										
		3-w, NPN	XU1/XU2 N18NP341●										
Design, high performance series	Compact and fiber	3-w, prog.	XU9/XU5 N18PP341●										
		3-w, prog.	XU9/XU5 N18NP341●										
		2-wire, PNP	XUY LCCLAR●●SP										

Compatibility

Specimen to be photocopied or use Modicon® M340™ Design software available on Web site: www.schneider-electric.us

The power required to supply each BMX XBP ●●00 rack depends on the type and number of modules installed. It is therefore necessary to create a power consumption table for each rack in order to define the most suitable BMX CPS ●●●0 power supply module for each rack. The table below can be used to calculate the consumption on the 2 or 3 different voltages (depending on model) to be supplied by the BMX CPS ●●●0 power supply module: --- 3,3 V, --- 24 V rack, --- 24 V sensors.

Procedure:

- Check and choose a power supply module corresponding to the power supplies available for the 2 or 3 voltages.
- Check that the total power absorbed on these three voltages does not exceed the overall power of the power supply module.
- Values to be entered according to the type of Modicon M340 configuration.

Rack no. 0 - 1 - 2 - 3	Module reference	Format S: standard D: double	Number	Consumption in mA (1)					
				Voltage --- 3,3 V		Voltage --- 24 V rack		Voltage --- 24 V sensors	
				Module	Total	Module	Total	Module	Total
Processors (rack 0)	BMX P34 1000	S	<input type="text"/>			72	<input type="text"/>		
	BMX P34 2000	S	<input type="text"/>			72	<input type="text"/>		
	BMX P34 2010	S	<input type="text"/>			90	<input type="text"/>		
	BMX P34 2020	S	<input type="text"/>			95	<input type="text"/>		
	BMX P34 2030	S	<input type="text"/>			135	<input type="text"/>		
Extension rack (rack 0, 1, 2 or 3)	BMX XBE 1000	-	<input type="text"/>	22	<input type="text"/>	160	<input type="text"/>		
Discrete I/O	BMX DAI 1602	S	<input type="text"/>	90	<input type="text"/>				
	BMX DAI 1603	S	<input type="text"/>	90	<input type="text"/>				
	BMX DAI 1604	S	<input type="text"/>	90	<input type="text"/>				
	BMX DAO 1605	S	<input type="text"/>	100	<input type="text"/>				
	BMX DDI 1602	S	<input type="text"/>	90	<input type="text"/>			60	<input type="text"/>
	BMX DDI 1603	S	<input type="text"/>	90	<input type="text"/>				
	BMX DDI 3202K	S	<input type="text"/>	140	<input type="text"/>			110	<input type="text"/>
	BMX DDI 6402K	S	<input type="text"/>	200	<input type="text"/>			110	<input type="text"/>
	BMX DDM 16022	S	<input type="text"/>	100	<input type="text"/>			30	<input type="text"/>
	BMX DDM 16025	S	<input type="text"/>	100	<input type="text"/>	50	<input type="text"/>	30	<input type="text"/>
	BMX DDM 3202K	S	<input type="text"/>	150	<input type="text"/>			55	<input type="text"/>
	BMX DDO 1602	S	<input type="text"/>	100	<input type="text"/>				
	BMX DDO 1612	S	<input type="text"/>	100	<input type="text"/>				
	BMX DDO 3202K	S	<input type="text"/>	150	<input type="text"/>				
	BMX DDO 6402K	S	<input type="text"/>	240	<input type="text"/>				
	BMX DRA 0805	S	<input type="text"/>	100	<input type="text"/>	55	<input type="text"/>		
	BMX DRA 1605	S	<input type="text"/>	100	<input type="text"/>	95	<input type="text"/>		
Analog I/O	BMX AMI 0410	S	<input type="text"/>	150	<input type="text"/>	45	<input type="text"/>		
	BMX AMM 0600	S	<input type="text"/>	150	<input type="text"/>	130	<input type="text"/>		
	BMX AMO 0210	S	<input type="text"/>	150	<input type="text"/>	110	<input type="text"/>		
	BMX ART 0414	S	<input type="text"/>	150	<input type="text"/>	40	<input type="text"/>		
	BMX ART 0814	S	<input type="text"/>	150	<input type="text"/>	100	<input type="text"/>		
Counting	BMX EHC 0200	S	<input type="text"/>	200	<input type="text"/>	40	<input type="text"/>	80	<input type="text"/>
	BMX EHC 0800	S	<input type="text"/>	200	<input type="text"/>			80	<input type="text"/>
Motion control	BMX MSP 0200	S	<input type="text"/>	200	<input type="text"/>	150	<input type="text"/>		<input type="text"/>
Communication	BMX NOE 0100	S	<input type="text"/>			90	<input type="text"/>		
	BMX NOE 0110	S	<input type="text"/>			90	<input type="text"/>		

Consumption per voltage

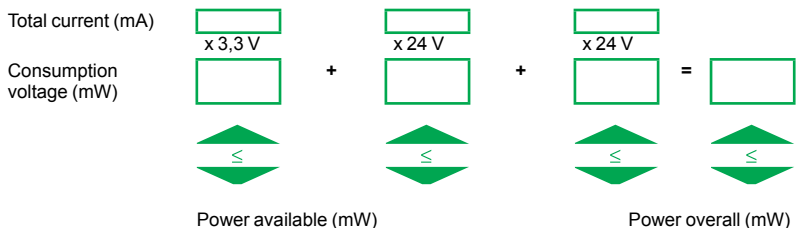

Choice of power supply	Module reference	Format	--- 24 V isolated	--- 24...48 V isolated	~ 100...240 V	--- 24 V rack	--- 24 V sensors
	BMX CPS 2010	D	8250	14850	8250	16 800	17 000
	BMX CPS 3020	D	14850	14850	8250	31 200	32 000
	BMX CPS 2000	D	8250	14850	8250	16 800	20 000
	BMX CPS 3500	D	14850	14850	8250	31 200	36 000
						10 800	21 600

(1) Typical value given for 100% of inputs or outputs at state 1.

110 XCA 282 01	4/39	ABE 7H08R21	5/8	ABE 7R16T332	5/10	BMX CPS 1000	1/13	BMX FTW 501	2/17
110 XCA 282 02	4/39	ABE 7H08S21	5/8	ABE 7R16T370	5/10	BMX CPS 2000	1/13	BMX FTW 501S	2/31
110 XCA 282 03	4/39	ABE 7H16C10	5/8	ABE 7S08S2B0	5/9	BMX CPS 2010	1/13	BMX MSP 0200	2/49
490 NOR 000 03	3/27	ABE 7H16C11	5/8	ABE 7S08S2B0E	5/9	BMX CPS 3020	1/13	BMX NOE 0100	3/23
490 NTC 000 05	3/26	ABE 7H16C21	5/8	ABE 7S08S2B1	5/9	BMX CPS 3500	1/13	BMX NOE 0110	3/23
490 NTC 000 05U	3/26	ABE 7H16C31	5/8	ABE 7S08S2B1E	5/9	BMX DAI 1602	2/16	BMX P34 1000	1/9
490 NTC 000 15	3/26	ABE 7H16F43	5/8	ABE 7S16E2B1	5/9	BMX DAI 1603	2/16		3/45
490 NTC 000 40	3/26	ABE 7H16R10	5/8	ABE 7S16E2B1E	5/9	BMX DAI 1604	2/16	BMX P34 2000	1/9
490 NTC 000 40U	3/26	ABE 7H16R11	5/8	ABE 7S16E2E0	5/9	BMX DAO 1605	2/16		3/45
490 NTC 000 80	3/26	ABE 7H16R11E	5/8	ABE 7S16E2E0E	5/9	BMX DDI 1602	2/16	BMX P34 2010	1/9
490 NTC 000 80U	3/26	ABE 7H16R20	5/8	ABE 7S16E2E1	5/9	BMX DDI 1603	2/16		3/41
490 NTW 000 02	3/26	ABE 7H16R21	5/8	ABE 7S16E2E1E	5/9	BMX DDI 3202K	2/16		3/45
490 NTW 000 02U	3/26	ABE 7H16R21E	5/8	ABE 7S16E2F0	5/9	BMX DDI 6402K	2/16	BMX P34 2020	1/9
490 NTW 000 05	3/26	ABE 7H16R30	5/8	ABE 7S16E2F0E	5/9	BMX DDM 16022	2/17		3/22
490 NTW 000 05U	3/26	ABE 7H16R31	5/8	ABE 7S16E2M0	5/9	BMX DDM 16025	2/17		3/45
490 NTW 000 12	3/26	ABE 7H16R50	5/8	ABE 7S16E2M0E	5/9	BMX DDM 3202K	2/17	BMX P34 2030	1/9;
490 NTW 000 12U	3/26	ABE 7H16R50E	5/8	ABE 7S16S1B2	5/9	BMX DDO 1602	2/16		3/22
490 NTW 000 40	3/26	ABE 7H16S21	5/8	ABE 7S16S1B2E	5/9	BMX DDO 1612	2/16		3/41
490 NTW 000 40U	3/26	ABE 7H16S21E	5/8	ABE 7S16S2B0	5/9	BMX DDO 3202K	2/16	BMX PAM 48000	1/19
490 NTW 000 80	3/26	ABE 7H16S43	5/8	ABE 7S16S2B0E	5/9	BMX DDO 6402K	2/16	BMX PAM 48200	1/19
490 NTW 000 80U	3/26	ABE 7H34E100	5/8	ABE 7TES160	5/13	BMX DRA 0805	2/16	BMX PDM 48000	1/19
499 NEH 104 10	3/28	ABE 7H34E200	5/8	ABL 1A02	5/25	BMX DRA 1605	2/16	BMX PDM 48200	1/19
499 NMS 181 00	3/30	ABE 7H34E300	5/8	ABL 8BBU24200	5/25	BMX EHC 0200	2/43	BMX PDM 64100	1/19
499 NMS 251 01	3/32	ABE 7LOGF25	5/13	ABL 8BPK24A03	5/25	BMX EHC 0800	2/43	BMX RMS 008MP	1/9
499 NMS 251 02	3/32	ABE 7LOGV10	5/13	ABL 8BPK24A12	5/25	BMX FCA150	2/31	BMX RMS 008MPF	1/9
499 NSS 251 01	3/32	ABE 7P08T330	5/11	ABL 8BUF24400	5/25	BMX FCA152	2/31	BMX RMS 128MPF	1/9
499 NSS 251 02	3/32	ABE 7P08T330E	5/11	ABL 8DCC05060	5/25	BMX FCA300	2/31	BMX RWS B000M	3/23
499 NTR 101 00	3/29	ABE 7P16F310	5/10	ABL 8DCC12020	5/25	BMX FCA302	2/31	BMX RWS FC032M	3/23
990 NAA 263 20	4/39	ABE 7P16F310E	5/10	ABL 8FUS0●	5/25	BMX FCA500	2/31	BMX XBC 008K	1/17
990 NAA 263 50	4/39	ABE 7P16F312	5/10	ABL 8PRP24100	5/25	BMX FCA502	2/31	BMX XBC 015K	1/17
		ABE 7P16M111	5/11	ABL 8RED24400	5/25	BMX FCC 051	2/17	BMX XBC 030K	1/17
		ABE 7P16T111	5/11	ABL 8RPM24200	5/25	BMX FCC 053	2/17	BMX XBC 050K	1/17
A		ABE 7P16T210	5/11	ABL 8RPS24030	5/25	BMX FCC 1001	2/17	BMX XBC 120K	1/17
ABE 7CPA21	5/11	ABE 7P16T212	5/11	ABL 8RPS24050	5/25	BMX FCC 1003	2/17	BMX XBE 1000	1/17
ABE 7ACC01	5/13	ABE 7P16T214	5/11	ABL 8RPS24100	5/25	BMX FCC 101	2/17	BMX XBE 2005	1/17
ABE 7ACC02	5/13	ABE 7P16T215	5/11	ABL 8WPS24200	5/25	BMX FCC 103	2/17	BMX XBP 0400	1/15
ABE 7ACC12	5/12	ABE 7P16T230	5/11	ABL 8WPS24400	5/25	BMX FCC 201	2/17	BMX XBP 0600	1/15
ABE 7ACC20	5/13	ABE 7P16T230E	5/11	ABR 7S11	5/12	BMX FCC 203	2/17	BMX XBP 0800	1/15
ABE 7ACC21	5/13	ABE 7P16T318	5/11	ABR 7S21	5/12	BMX FCC 301	2/17	BMX XBP 1200	1/15
ABE 7ACC30	5/13	ABE 7P16T318E	5/11	ABR 7S23	5/12	BMX FCC 303	2/17	BMX XCA USB H045	4/39
ABE 7ACC80	5/13	ABE 7P16T330	5/11	ABR 7S33	5/12	BMX FCC 501	2/17	BMX XEM 010	1/15
ABE 7ACC81	5/13	ABE 7P16T330E	5/11	ABR 7S33E	5/12	BMX FCC 503	2/17	BMX XSP 0400	1/15
ABE 7ACC82	5/13	ABE 7P16T332	5/11	ABR 7S37	5/12	BMX FCW 1001	2/17	BMX XSP 0600	1/15
ABE 7ACC83	5/13	ABE 7P16T334	5/11	ABS 7EA3E5	5/12	BMX FCW 1003	2/17	BMX XSP 0800	1/15
ABE 7ACC84	5/13	ABE 7R08S111	5/9	ABS 7EA3M5	5/12	BMX FCW 301	2/17	BMX XSP 1200	1/15
ABE 7ACC85	5/13	ABE 7R08S111E	5/9	ABS 7EC3AL	5/12	BMX FCW 301S	2/31	BMX XTS HSC 20	2/43
ABE 7BV10	5/13	ABE 7R08S210	5/9	ABS 7EC3B2	5/12	BMX FCW 303	2/17	BMX XCA USB H018	1/9
ABE 7BV10E	5/13	ABE 7R08S210E	5/9	ABS 7EC3E2	5/12	BMX FCW 501	2/17		4/39
ABE 7BV20	5/13	ABE 7R08S216	5/9	ABS 7SA2M	5/12	BMX FCW 501S	2/31	BMX XCA USB H045	1/9
ABE 7BV20E	5/13	ABE 7R08S216E	5/9	ABS 7SA3MA	5/12	BMX FCW 503	2/17		4/39
ABE 7CPA21	2/31	ABE 7R16M111	5/10	ABS 7SC1B	5/12	BMX FTB 2000	2/17	BMX XTS CPS●0	1/13
	5/11	ABE 7R16S111	5/9	ABS 7SC2E	5/12		2/31		
ABE 7CPA410	2/31	ABE 7R16S111E	5/9	ABS 7SC3BA	5/12		2/43		
	5/11	ABE 7R16S210	5/9	ABS 7SC3E	5/12	BMX FTB 2010	2/17		
ABE 7CPA412	2/31	ABE 7R16S210E	5/9	AM0 2CA 001V000	3/43		2/31		
	5/11	ABE 7R16S212	5/9	AR1 SB3	5/13		2/43		
ABE 7FU012	5/13	ABE 7R16S212E	5/9	ASI20 MACC5	5/25	BMX FTB 2020	2/17		
ABE 7FU050	5/13	ABE 7R16T111	5/10				2/31		
ABE 7FU100	5/13	ABE 7R16T210	5/10	B			2/43		
ABE 7FU200	5/13	ABE 7R16T212	5/10	BMX AMI 0410	2/31		2/43		
ABE 7FU400	5/13	ABE 7R16T230	5/10	BMX AMM 0600	2/31	BMX FTB 2820	2/49	FTX BLA10	3/43
ABE 7FU630	5/13	ABE 7R16T231	5/10	BMX AMO 0210	2/31	BMX FTW 1001	2/17	FTX C78B	3/43
ABE 7H08R10	5/8	ABE 7R16T231	5/10	BMX ART 0414	2/31	BMX FTW 301	2/17	FTX C78F5	3/43
ABE 7H08R11	5/8	ABE 7R16T330	5/10	BMX ART 0814	2/31	BMX FTW 301S	2/31	FTX C78M5	3/43
							2/43	FTX CM08B	3/43
							2/43	FTX CM12B	3/43
							2/49	FTX CN 12F5	3/42
							2/17	FTX CN 12M5	3/42
							2/17	FTX CN 3203	3/42
							2/31	FTX CN 3206	3/42

Schneider Electric USA, Inc.

8001 Knightdale Blvd.
Knightdale, NC 27545
Tel: 919-266-3671

19 Waterman Avenue
Toronto, Ontario M4B 1Y2
Tel: 416-752-8020

<http://www.schneider-electric.us/>

The information and dimensions in this catalog are provided for the convenience of our customers. While this information is believed to be accurate, Schneider Electric reserves the right to make updates and changes without prior notification and assumes no liability for any errors or omissions.

Design: Schneider Electric
Photos: Schneider Electric



2010

Modicon® M340™ automation platform

Schneider
Electric

X-ON Electronics

Largest Supplier of Electrical and Electronic Components

Click to view similar products for [schneider](#) manufacturer:

Other Similar products are found below :

[LU9M1](#) [7D](#) [7S](#) [7XA1](#) [FNQR2](#) [8501RS44V24](#) [8501RSD14P14V51](#) [8501XO20V03Y414](#) [9001KXRK](#) [9001SKR9P35RH25](#) [9001SKT35L31](#)
[9003K2C003GA](#) [9007AA1](#) [9007BA1](#) [9007C54D](#) [9007C62A2](#) [9007CA11](#) [9007FA3](#) [9007HA4](#) [9007HA6](#) [9007KA1](#) [9007KB11](#)
[9007MS01S0206](#) [9007MS02S0300](#) [9012GAR4](#) [9012GAW2](#) [9012GBW1](#) [9012GDW5E3](#) [9012GFW1](#) [9012GNG1](#) [9012GNG3](#) [9012GNG6](#)
[9013FHG39J69](#) [9013GHG2J30](#) [9050JCK2F30V14](#) [GV2ME04](#) [GV2ME10](#) [GV2ME14](#) [GV2ME20](#) [GV2ME32](#) [GV2P06](#) [GV2P08](#) [GV2P10](#)
[GV2P16](#) [GV2P20](#) [GV2P21](#) [GV2RT07](#) [GV2RT21](#) [GVAD1001](#) [GVAN11](#)