

SFH756 / SFH756V

Plastic Fiber Optic Transmitter Diode

Plastic Connector Housing



Data Sheet

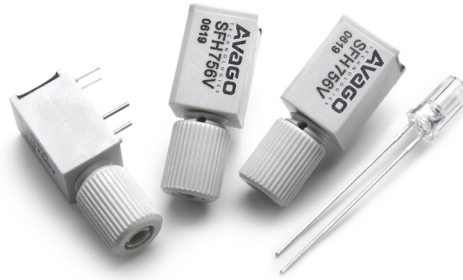

Description

The SFH756 is a low-cost transmitter for simple optical data transmission with polymer optical fiber. The 650nm LED allows for speeds up to 10MBd.

The transparent plastic package has an aperture where the 2.2mm fiber-end can be inserted and fixed with glue. This easy coupling method is extremely cost-effective.

The V-housing allows easy coupling of unconnectorized 2.2mm plastic optical fiber by means of an axial locking screw.

Ordering Information

Type	Ordering Code
SFH756	SP000063802
SFH756V	SP000063814

Features

- 2.2 mm Aperture holds Standard 1000 Micron Plastic Fiber
- No Fiber Stripping Required
- Good Linearity (Forward current > 2 mA)
- Molded Microlens for Efficient Coupling

Plastic Connector Housing

- Mounting Screw Attached to the Connector
- Interference Free Transmission from light-Tight Housing
- Transmitter and Receiver can be flexibly positioned
- No Cross Talk
- Auto insertable and Wave solderable
- Supplied in Tubes

Applications

- Household Electronics
- Power Electronics
- Optical Networks
- Light Barriers

Technical Data

Absolute Maximum Ratings

Parameter	Symbol	Limit Values		Unit
		min.	max.	
Operating Temperature Range	T_{OP}	-40	+85	°C
Storage Temperature Range	T_{STG}	-40	+100	°C
Junction Temperature	T_J		100	°C
Soldering Temperature (27mm from case bottom, $t \leq 5$ s)	T_S		260	°C
Reverse Voltage	V_R		3	V
Forward Current	I_F		50	mA
Surge Current ($t \leq 10$ μ s, $D = 0$)	I_{FSM}		1	A
Power Dissipation	P_{TOT}		120	mW
Thermal Resistance, Junction/Air	R_{thJA}		450	K/W

Characteristics ($T_A = 25^\circ\text{C}$)

Parameter	Symbol	Value	Unit
Peak Wavelength	λ_{Peak}	660	nm
Spectral Bandwidth	$\Delta\lambda$	25	nm
Switching Times ($R_G = 50 \Omega$, $I_{F(Low)} = 0.1$ mA, $I_{F(High)} = 50$ mA)			μ s
10% to 90%	t_R	0.1	
90% to 10%	t_F	0.1	
Capacitance ($f = 1$ MHz, $V_R = 0$ V)	C_0	30	pF
Forward Voltage ($I_F = 50$ mA)	V_F	2.1 (≤ 2.8)	V
Output Power Coupled Into Plastic Fiber ($I_F = 10$ mA) [1]	Φ_{IN}	200 (≥ 100)	μ W
Temperature Coefficient Φ_{IN}	$T_{C\Phi}$	-0.4	%/K
Temperature Coefficient V_F	T_{CV}	-3	mV/K
Temperature Coefficient λ_{Peak}	$T_{C\lambda}$	0.16	nm/K

Notes:

1. The output power coupled into plastic fiber is measured with a large area detector after a short fiber (about 30 cm). This value must not be used for calculating the power budget for a fiber optic system with a long fiber because the numerical aperture of plastic fibers is decreasing on the first meters. Therefore the fiber seems to have compared with the specified value a higher attenuation on the first meters.

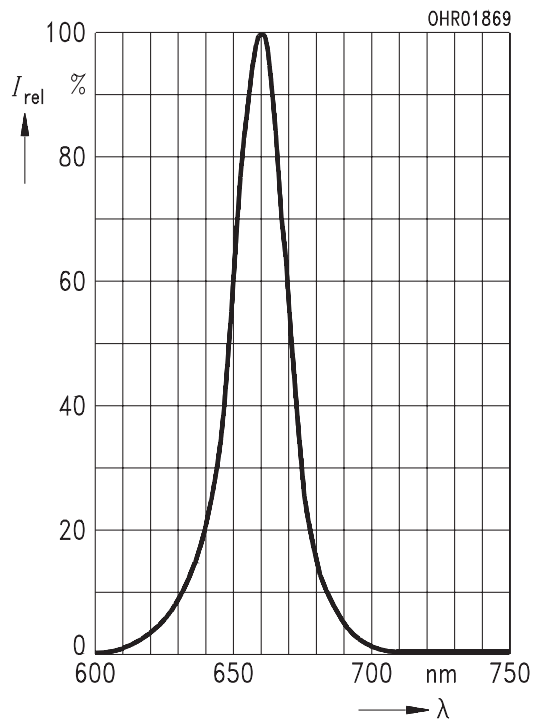

Figure 1. Relative Spectral Emission $I_{rel} = f(\lambda)$

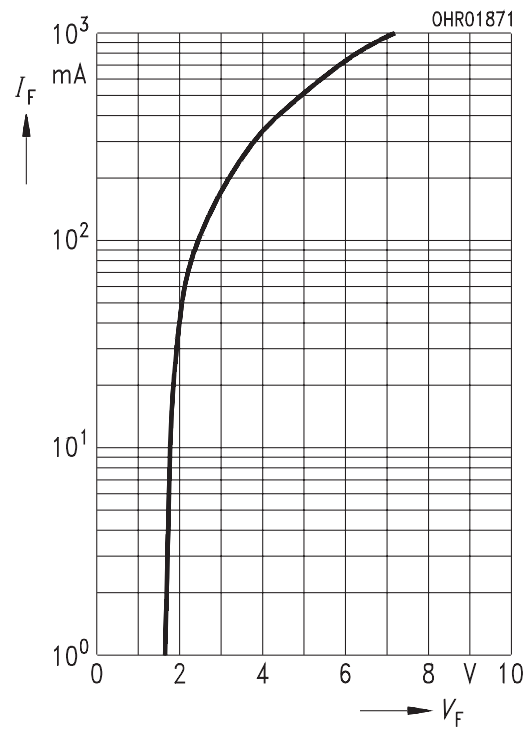

Figure 2. Forward Current $I_F = f(V_F)$ single pulse, duration = 20 μ s

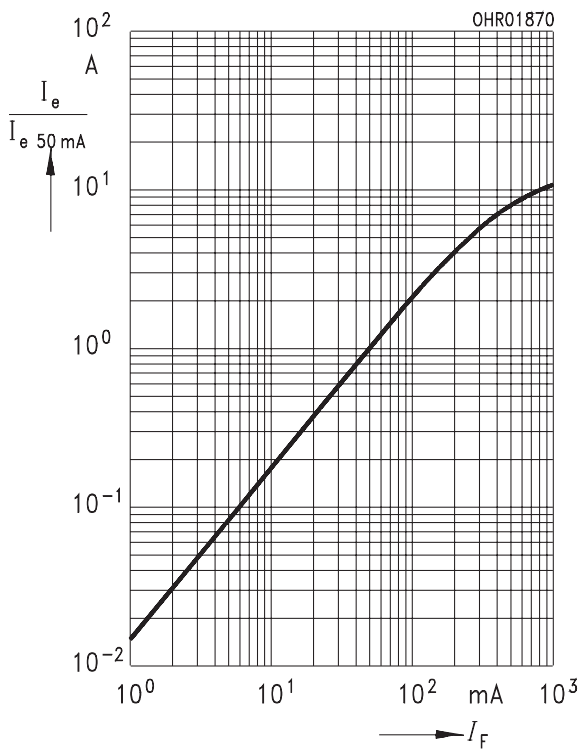

Figure 3. Relative Output Power, $I_e/I_{e(50\text{ mA})} = f(I_F)$ single pulse, duration = 20 μ s

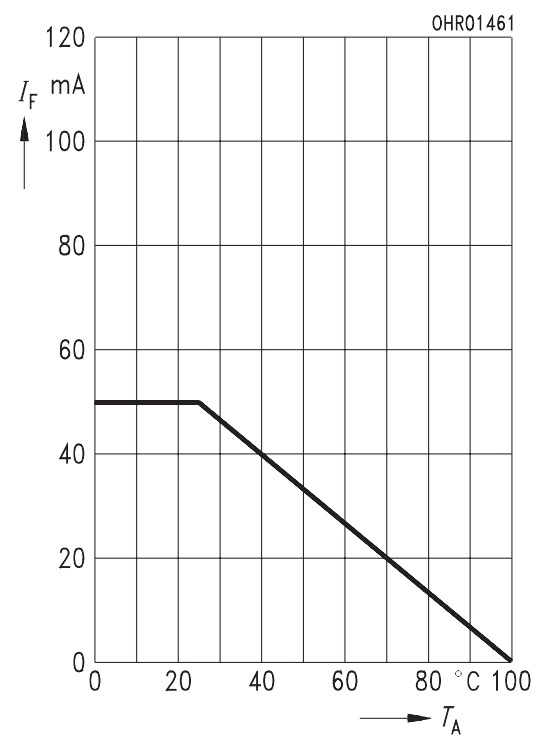

Figure 4. Maximum Permissible Forward Current, $I_F = f(T_A)$, $R_{thJA} = 450\text{ K/W}$

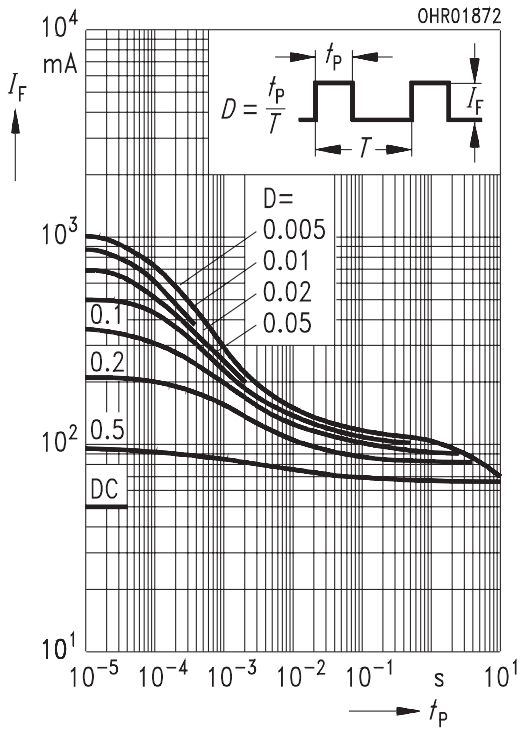
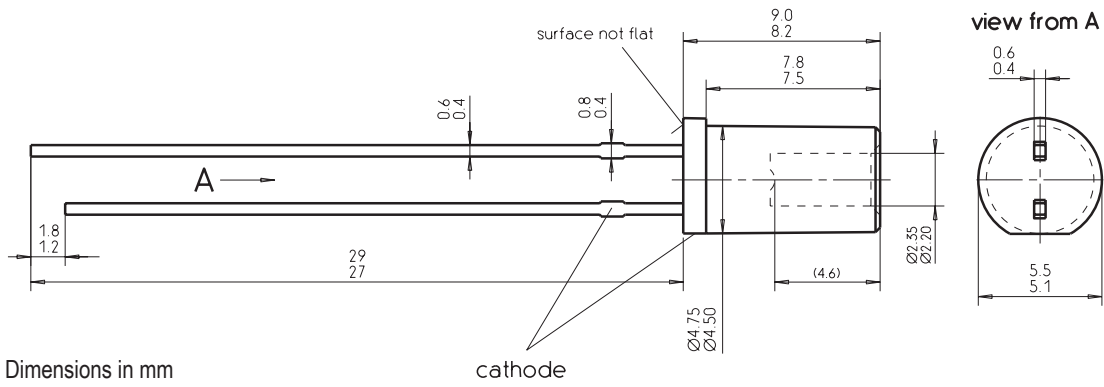

Figure 5. Permissible Pulse Handling Capability, $I_F = f(t_P)$, duty cycle $D =$ parameter, $T_A = 25^\circ\text{C}$

Package Outlines



Dimensions in mm

Figure 6. SFH756

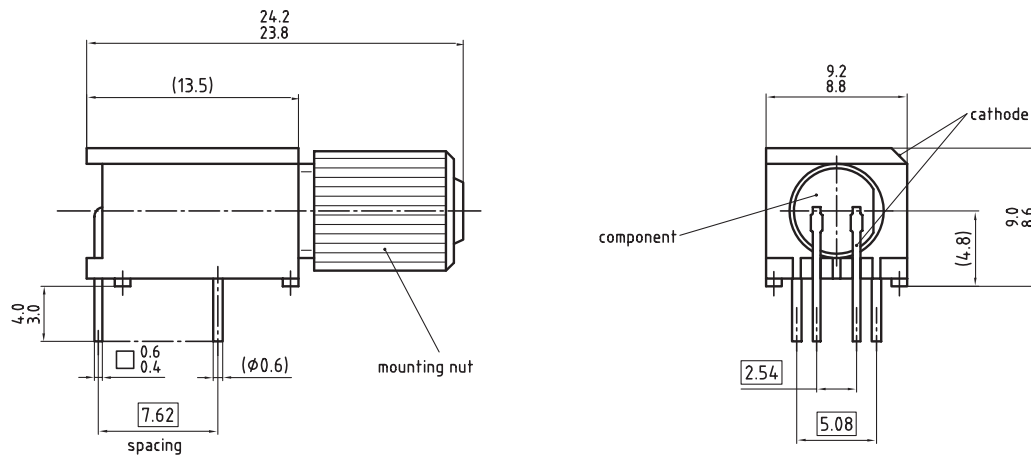

Dimensions in mm

Figure 7. SFH756V

Disclaimer

The information herein is given to describe certain components and shall not be considered as a guarantee of characteristics.

Terms of delivery and rights to technical change reserved. We hereby disclaim any and all warranties, including but not limited to warranties of non-infringement, regarding circuits, descriptions and charts stated herein.

Warnings

Due to technical requirements components may contain dangerous substances. For information on the types in question please contact your nearest Avago Technologies Office.

Avago Technologies Components may only be used in life-support devices or systems with the express written approval of Avago Technologies, if a failure of such components can reasonably be expected to cause the failure of that life-support device or system, or to affect the safety or effectiveness of that device or system. Life support devices or systems are intended to be implanted in the human body, or to support and/or maintain and sustain and/or protect human life. If they fail, it is reasonable to assume that the health of the user or other persons maybe endangered.

Information

For further information on technology, delivery terms and conditions and prices please contact your nearest Avago Technologies Office (www.avagotech.com).

For product information and a complete list of distributors, please go to our web site: www.avagotech.com

Avago, Avago Technologies, and the A logo are trademarks of Avago Technologies, Limited in the United States and other countries.
Data subject to change. Copyright © 2007 Avago Technologies Limited. All rights reserved.
AV01-0715EN - June 30, 2007

Avago
TECHNOLOGIES

X-ON Electronics

Largest Supplier of Electrical and Electronic Components

Click to view similar products for [avago manufacturer](#):

Other Similar products are found below :

[ACPL-C790-500E](#) [PEX8724-CA RDK](#) [HCMS-2962](#) [HCPL-0611-000E](#) [HEDM-5500#B02](#) [HEDS-8937](#) [HEDS-9731#A50](#) [HFBR-5961ALZ](#)
[HEDS-5505-A06](#) [HCPL-2631-000E](#) [ACPL-K64L-060E](#) [AFBR-5803AZ](#) [PEX8747-CA RDK](#) [HCPL-5431](#) [HFBR-2316TZ](#) [409091B](#) [5962-](#)
[8957201XA](#) [610861X](#) [610962A](#) [6N140A/883B](#) [8302401EC](#) [HCPL-0731-500E](#) [HEDS-8949](#) [ACSL-6410-00TE](#) [HLMP-2550](#) [ACPL-K342-](#)
[060E](#) [4N46](#) [PEX8747-CA80BC G](#) [HCNW4503-000E](#) [HFBR-1415TZ](#) [HCPL-0600-500E](#) [HCPL-0930-000E](#) [HEDL-5540-I06](#) [HCPL-5401](#)
[HLMP-1301-E00A1](#) [HCPL-4503-520E](#) [HEDS-5540#I06](#) [HEDS-6140#B09](#) [HCMS-3906](#) [HEDS-9700H52](#) [HFBR-1515BZ](#) [ACPL-5631L](#)
[HLMA-QL00](#) [HSSR-7112](#) [HDLS-1414](#) [HFBR-RSD005Z](#) [HLMP-1540](#) [055407X](#) [5962-8876801PA](#) [HCMS-2922](#)