

# SFH250 / SFH250V

## Plastic Fiber Optic Photodiode Detector

### Plastic Connector Housing



## Data Sheet

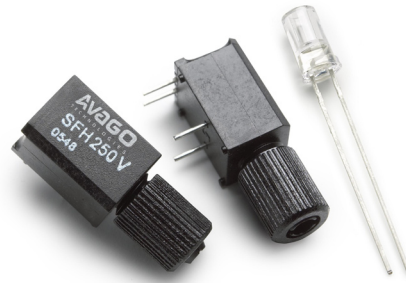

### Description

The SFH250 is a low-cost 650nm receiver diode for simple optical data transmission with polymer optical fiber. It incorporates an analog photodiode and can be used for speeds up to 100MBd.

The transparent plastic package has an aperture where the 2.2mm fiber end can be inserted and fixed with glue. This easy coupling method is extremely cost-effective.

The V-housing allows easy coupling of unconnectorized 2.2mm plastic optical fiber by means of an axial locking screw.

### Ordering Information

Type	Ordering Code
SFH250	SP000063866
SFH250V	SP000063852

### Features

- 2.2 mm Aperture holds Standard 1000 Micron Plastic Fiber
- No Fiber Stripping Required
- Fast Switching Time
- Good Linearity
- Sensitive in visible and near IR Range
- Molded Microlens for Efficient Coupling

### Plastic Connector Housing

- Mounting Screw Attached to the Connector
- Interference Free Transmission from light-Tight Housing
- Transmitter and Receiver can be flexibly positioned
- No Cross Talk
- Auto insertable and Wave solderable
- Supplied in Tubes

### Applications

- Household Electronics
- Power Electronics
- Optical Networks
- Light Barriers

## Technical Data

### Absolute Maximum Ratings

Parameter	Symbol	Limit Values		Unit
		min.	max.	
Operating Temperature Range	$T_{OP}$	-40	+85	°C
Storage Temperature Range	$T_{STG}$	-40	+100	°C
Junction Temperature	$T_J$		100	°C
Soldering Temperature (2mm from case bottom, $t \leq 5$ s)	$T_S$		260	°C
Reverse Voltage	$V_R$		30	V
Power Dissipation	$P_{TOT}$		100	mW
Thermal Resistance, Junction/Air	$R_{thJA}$		750	K/W

### Characteristics ( $T_A = 25^\circ\text{C}$ )

Parameter	Symbol	Values			Unit
		Min	Typ	Max	
Maximum Photosensitivity Wavelength	$\lambda_{Smax}$		850		nm
Photosensitivity Spectral Range ( $S = 10\% S_{max}$ )	$\lambda$	400		1100	nm
Dark Current ( $V_R = 20$ V)	$I_R$		1 ( $\leq 10$ )		nA
Capacitance ( $f = 1$ MHz, $V_R = 0$ V)	$C_0$		11		pF
Rise and Fall Times of Photo Current ( $R_L = 50 \Omega$ , $V_R = 30$ V, $\lambda = 880$ nm)					$\mu\text{s}$
10% to 90%	$t_R$		0.01		
90% to 10%	$t_F$		0.01		
Photo Current ( $\Phi_{IN} = 10 \mu\text{W}$ coupled from the end of a plastic fiber, $V_R = 5$ V)					$\mu\text{A}$
$\lambda = 660$ nm	$I_P$		3 ( $\geq 1.6$ )		
$\lambda = 950$ nm			4 ( $\geq 2.5$ )		
Temperature Coefficient $I_P \lambda = 560$ to $660$ nm	$TC_I$		-0.04		%/K
Temperature Coefficient $I_P \lambda = 830$ nm			0.04		
Temperature Coefficient $I_P \lambda = 950$ nm			0.2		

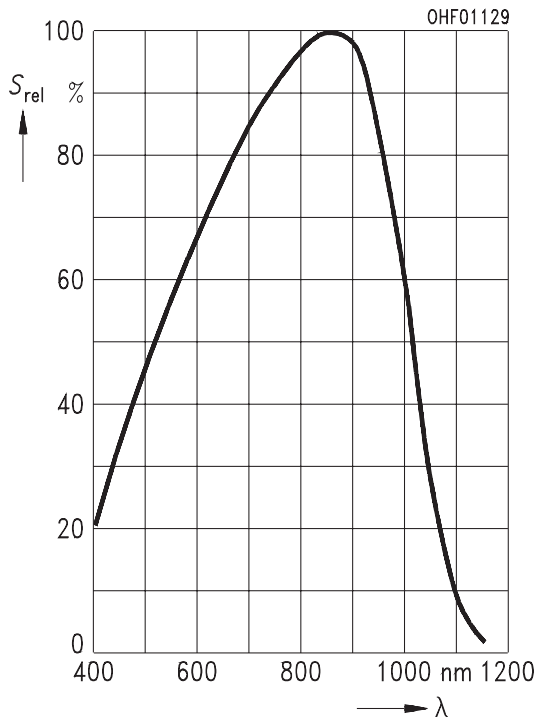

Figure 1. Relative Spectral Sensitivity  $S_{rel} = f(\lambda)$

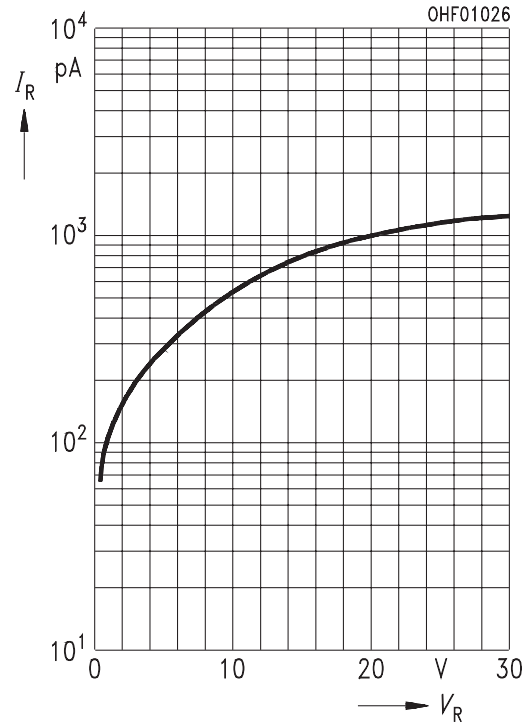

Figure 2. Dark Current  $I_R = f(V_R)$ ,  $T_A = 25^\circ\text{C}$

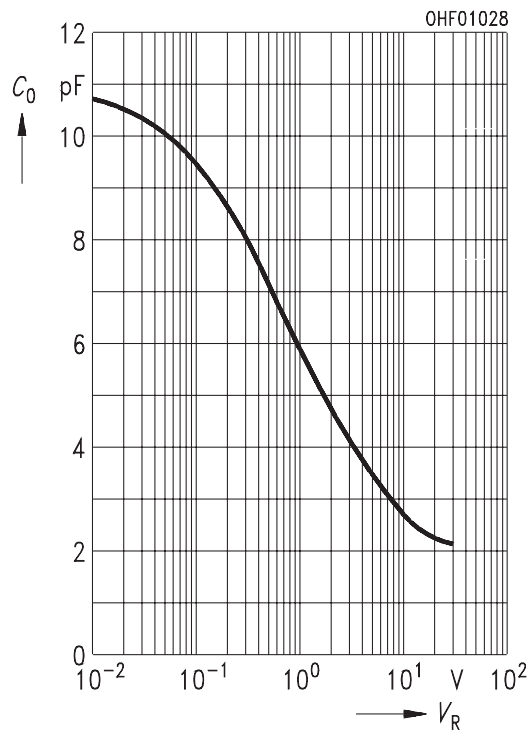

Figure 3. Capacitance  $C_0 = f(V_R)$ ,  $f = 1\text{ MHz}$ ,  $E_V = 0$

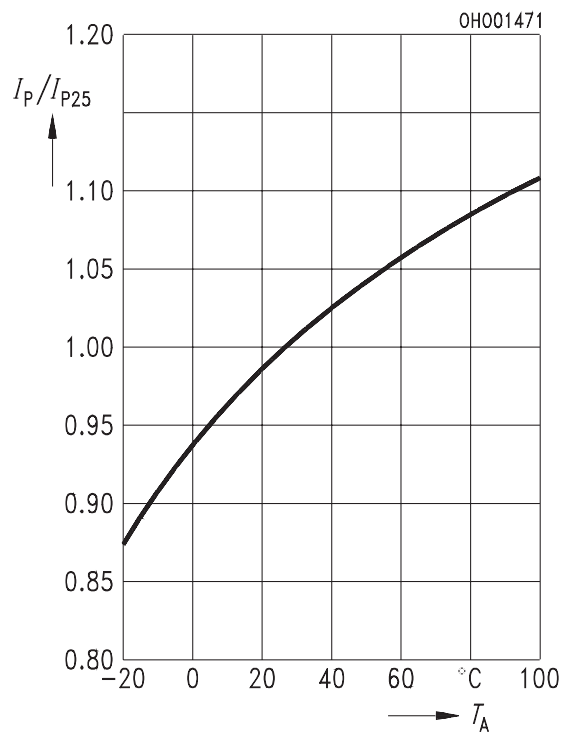
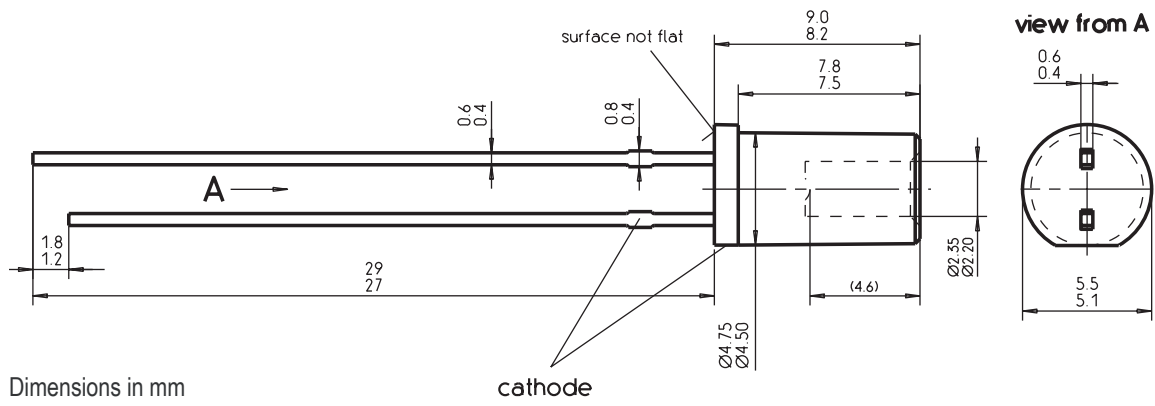

Figure 4. Photocurrent  $I_P/I_{P25} = f(T_A)$ ,  $\lambda = 950\text{ nm}$

## Package Outlines



Dimensions in mm

Figure 5. SFH250

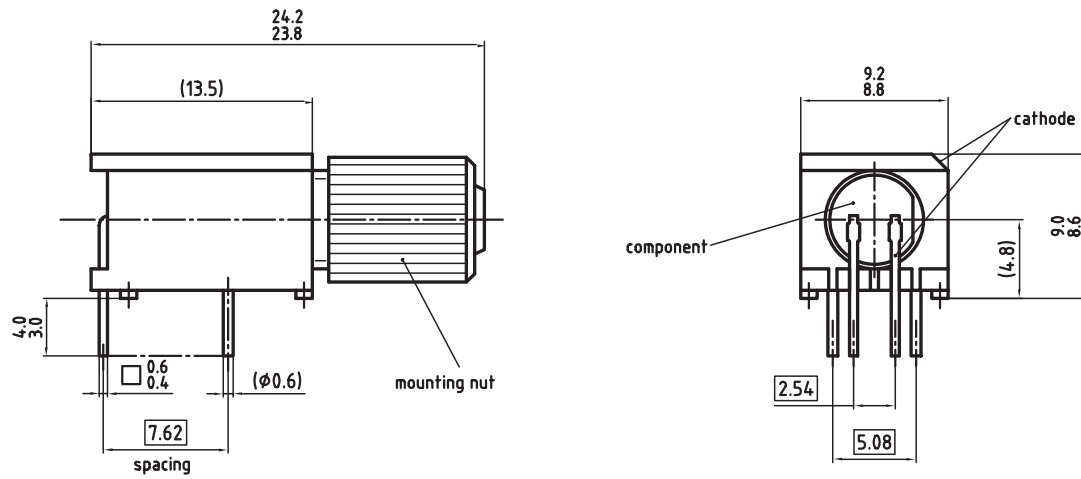

Dimensions in mm

Figure 6. SFH250V

## **Disclaimer**

The information herein is given to describe certain components and shall not be considered as a guarantee of characteristics.

Terms of delivery and rights to technical change reserved. We hereby disclaim any and all warranties, including but not limited to warranties of non-infringement, regarding circuits, descriptions and charts stated herein.

## **Warnings**

Due to technical requirements components may contain dangerous substances. For information on the types in question please contact your nearest Avago Technologies Office.

Avago Technologies Components may only be used in life-support devices or systems with the express written approval of Avago Technologies, if a failure of such components can reasonably be expected to cause the failure of that life-support device or system, or to affect the safety or effectiveness of that device or system. Life support devices or systems are intended to be implanted in the human body, or to support and/or maintain and sustain and/or protect human life. If they fail, it is reasonable to assume that the health of the user or other persons may be endangered.

## **Information**

For further information on technology, delivery terms and conditions and prices please contact your nearest Avago Technologies Office ([www.avagotech.com](http://www.avagotech.com)).

For product information and a complete list of distributors, please go to our web site: [www.avagotech.com](http://www.avagotech.com)

Avago, Avago Technologies, and the A logo are trademarks of Avago Technologies, Limited in the United States and other countries.  
Data subject to change. Copyright © 2007 Avago Technologies Limited. All rights reserved.  
AV01-0711EN - July 18, 2007

**Avago**  
TECHNOLOGIES

## X-ON Electronics

Largest Supplier of Electrical and Electronic Components

*Click to view similar products for [Broadcom](#) manufacturer:*

Other Similar products are found below :

[BCM54280C1KFBG](#) [MGA-634P8-TR1G](#) [5962-8981001XA](#) [HEDS-5645-H06](#) [BCM54616C0IFBG](#) [PEX9749-AARDK](#) [HEDS-8904](#) [ASMT-JR10-ARS01](#) [BCM54220SB0KQLEG](#) [HCPL-5430](#) [HCPL-0720](#) [BCM5482SHEA2KFBG](#) [PEX8750-AB RDK](#) [BCM53405A0KFSBG](#) [05-25704-00](#) [QMINI UV](#) [AFBR-S20M2WV](#) [A25E-0030](#) [LP16-LW-OPT-2](#) [ACPL-054L-500E](#) [AFBR-5805ATZ](#) [HDSP-815E](#) [BCM8727MCIFBG](#) [5962-8876903FC](#) [HEDS-5540#A12](#) [ACPL-K43T-000E](#) [H5-25460-00](#) [AFBR-S20M2UV](#) [AFBR-S20M2NI](#) [ACPL-024L-500E](#) [AFBR-HUD500Z](#) [PEX-CABLEAD-KIT-8732](#) [HDSP-0762](#) [HDSP-2113](#) [HSMS-8209-BLKG](#) [AFBR-5905Z](#) [HEDS-8949](#) [HCPL-7721-000E](#) [HFBR-4597Z](#) [BCM56450B1IFSBG](#) [BCM56960B1KFSBG](#) [BCM56842A1KFTBG](#) [HCPL-5231#300](#) [HSMA-C110](#) [HCPL-2631-000E](#) [HCPL-5731](#) [ACPL-K376-000E](#) [HLMP-6400](#) [05-25708-00](#) [05-25420-17](#)