



**128K x 36, 256K x 18,
3.3V Synchronous ZBT™ SRAMs
3.3V I/O, Burst Counter,
Flow-Through Outputs**

**IDT71V3557S
IDT71V3559S
IDT71V3557SA
IDT71V3559SA**

Features

- ◆ 128K x 36, 256K x 18 memory configurations
- ◆ Supports high performance system speed - 100 MHz (7.5 ns Clock-to-Data Access)
- ◆ ZBT™ Feature - No dead cycles between write and read cycles
- ◆ Internally synchronized output buffer enable eliminates the need to control OE
- ◆ Single R/W (READ/WRITE) control pin
- ◆ 4-word burst capability (Interleaved or linear)
- ◆ Individual byte write (BW1 - BW4) control (May tie active)
- ◆ Three chip enables for simple depth expansion
- ◆ 3.3V power supply (±5%), 3.3V (±5%) I/O Supply (VDDO)
- ◆ Optional Boundary Scan JTAG Interface (IEEE 1149.1 complaint)
- ◆ Packaged in a JEDEC Standard 100-pin plastic thin quad flatpack (TQFP), 119 ball grid array (BGA) and 165 fine pitch ball grid array (fBGA)

Description

The IDT71V3557/59 are 3.3V high-speed 4,718,592-bit (4.5 Mega-bit) synchronous SRAMs organized as 128K x 36/256K x 18. They are designed to eliminate dead bus cycles when turning the bus around between reads and writes, or writes and reads. Thus they have been given the name ZBT™, or Zero Bus Turnaround.

Address and control signals are applied to the SRAM during one clock cycle, and on the next clock cycle the associated data cycle occurs, be

it read or write.

The IDT71V3557/59 contain address, data-in and control signal registers. The outputs are flow-through (no output data register). Output enable is the only asynchronous signal and can be used to disable the outputs at any given time.

A Clock Enable (CEN) pin allows operation of the IDT71V3557/59 to be suspended as long as necessary. All synchronous inputs are ignored when (CEN) is high and the internal device registers will hold their previous values.

There are three chip enable pins (CE1, CE2, CE2) that allow the user to deselect the device when desired. If any one of these three is not asserted when ADV/LD is low, no new memory operation can be initiated. However, any pending data transfers (reads or writes) will be completed. The data bus will tri-state one cycle after chip is deselected or a write is initiated.

The IDT71V3557/59 have an on-chip burst counter. In the burst mode, the IDT71V3557/59 can provide four cycles of data for a single address presented to the SRAM. The order of the burst sequence is defined by the LBO input pin. The LBO pin selects between linear and interleaved burst sequence. The ADV/LD signal is used to load a new external address (ADV/LD = LOW) or increment the internal burst counter (ADV/LD = HIGH).

The IDT71V3557/59 SRAMs utilize IDT's latest high-performance CMOS process and are packaged in a JEDEC standard 14mm x 20mm 100-pin thin plastic quad flatpack (TQFP) as well as a 119 ball grid array (BGA) and a 165 fine pitch ball grid array (fBGA).

Pin Description Summary

| | | | |
|-------------------------|--|--------|--------------|
| A0-A17 | Address Inputs | Input | Synchronous |
| CE1, CE2, CE2 | Chip Enables | Input | Synchronous |
| OE | Output Enable | Input | Asynchronous |
| R/W | Read/Write Signal | Input | Synchronous |
| CEN | Clock Enable | Input | Synchronous |
| BW1, BW2, BW3, BW4 | Individual Byte Write Selects | Input | Synchronous |
| CLK | Clock | Input | N/A |
| ADV/LD | Advance burst address / Load new address | Input | Synchronous |
| LBO | Linear / Interleaved Burst Order | Input | Static |
| TMS | Test Mode Select | Input | Synchronous |
| TDI | Test Data Input | Input | Synchronous |
| TCK | Test Clock | Input | N/A |
| TDO | Test Data Output | Output | Synchronous |
| TRST | JTAG Reset (Optional) | Input | Asynchronous |
| ZZ | Sleep Mode | Input | Synchronous |
| I/O0-I/O31, I/OP1-I/OP4 | Data Input / Output | I/O | Synchronous |
| VDD, VDDO | Core Power, I/O Power | Supply | Static |
| VSS | Ground | Supply | Static |

5282 tbl 01

DECEMBER 2005

Pin Definitions (1)

| Symbol | Pin Function | I/O | Active | Description |
|---------------------------|-------------------------------|-----|--------|---|
| A0-A17 | Address Inputs | I | N/A | Synchronous Address inputs. The address register is triggered by a combination of the rising edge of CLK, ADV/LD low, CEN low, and true chip enables. |
| ADV/LD | Advance / Load | I | N/A | ADV/LD is a synchronous input that is used to load the internal registers with new address and control when it is sampled low at the rising edge of clock with the chip selected. When ADV/LD is low with the chip deselected, any burst in progress is terminated. When ADV/LD is sampled high then the internal burst counter is advanced for any burst that was in progress. The external addresses are ignored when ADV/LD is sampled high. |
| R/W | Read / Write | I | N/A | R/W signal is a synchronous input that identifies whether the current load cycle initiated is a Read or Write access to the memory array. The data bus activity for the current cycle takes place one clock cycle later. |
| CEN | Clock Enable | I | LOW | Synchronous Clock Enable Input. When CEN is sampled high, all other synchronous inputs, including clock are ignored and outputs remain unchanged. The effect of CEN sampled high on the device outputs is as if the low to high clock transition did not occur. For normal operation, CEN must be sampled low at rising edge of clock. |
| BW1-BW4 | Individual Byte Write Enables | I | LOW | Synchronous byte write enables. Each 9-bit byte has its own active low byte write enable. On load write cycles (When R/W and ADV/LD are sampled low) the appropriate byte write signal (BW1-BW4) must be valid. The byte write signal must also be valid on each cycle of a burst write. Byte Write signals are ignored when R/W is sampled high. The appropriate byte(s) of data are written into the device one cycle later. BW1-BW4 can all be tied low if always doing write to the entire 36-bit word. |
| CE1, CE2 | Chip Enables | I | LOW | Synchronous active low chip enable. CE1 and CE2 are used with CE2 to enable the IDT71V3557/59. (CE1 or CE2 sampled high or CE2 sampled low) and ADV/LD low at the rising edge of clock, initiates a deselect cycle. The ZBT™ has a one cycle deselect, i.e., the data bus will tri-state one clock cycle after deselect is initiated. |
| CE2 | Chip Enable | I | HIGH | Synchronous active high chip enable. CE2 is used with CE1 and CE2 to enable the chip. CE2 has inverted polarity but otherwise identical to CE1 and CE2. |
| CLK | Clock | I | N/A | This is the clock input to the IDT71V3557/59. Except for OE, all timing references for the device are made with respect to the rising edge of CLK. |
| I/O0-I/O31 I/OP1-I/OP4 | Data Input/Output | I/O | N/A | Data input/output (I/O) pins. The data input path is registered, triggered by the rising edge of CLK. The data output path is flow-through (no output register). |
| LBO | Linear Burst Order | I | LOW | Burst order selection input. When LBO is high the Interleaved burst sequence is selected. When LBO is low the Linear burst sequence is selected. LBO is a static input, and it must not change during device operation. |
| OE | Output Enable | I | LOW | Asynchronous output enable. OE must be low to read data from the 71V3557/59. When OE is HIGH the I/O pins are in a high-impedance state. OE does not need to be actively controlled for read and write cycles. In normal operation, OE can be tied low. |
| TMS | Test Mode Select | I | N/A | Gives input command for TAP controller. Sampled on rising edge of TDK. This pin has an internal pullup. |
| TDI | Test Data Input | I | N/A | Serial input of registers placed between TDI and TDO. Sampled on rising edge of TCK. This pin has an internal pullup. |
| TCK | Test Clock | I | N/A | Clock input of TAP controller. Each TAP event is clocked. Test inputs are captured on rising edge of TCK, while test outputs are driven from the falling edge of TCK. This pin has an internal pullup. |
| TDO | Test Data Output | O | N/A | Serial output of registers placed between TDI and TDO. This output is active depending on the state of the TAP controller. |
| TRST | JTAG Reset (Optional) | I | LOW | Optional Asynchronous JTAG reset. Can be used to reset the TAP controller, but not required. JTAG reset occurs automatically at power up and also resets using TMS and TCK per IEEE 1149.1. If not used TRST can be left floating. This pin has an internal pullup. |
| ZZ | Sleep Mode | I | HIGH | Synchronous sleep mode input. ZZ HIGH will gate the CLK internally and power down the IDT71V3557/3559 to its lowest power consumption level. Data retention is guaranteed in Sleep Mode. This pin has an internal pulldown. |
| VDD | Power Supply | N/A | N/A | 3.3V core power supply. |
| VDDQ | Power Supply | N/A | N/A | 3.3V I/O Supply. |
| VSS | Ground | N/A | N/A | Ground. |

5282 tbl 02

NOTE:

1. All synchronous inputs must meet specified setup and hold times with respect to CLK.

Functional Block Diagram — 128K x 36

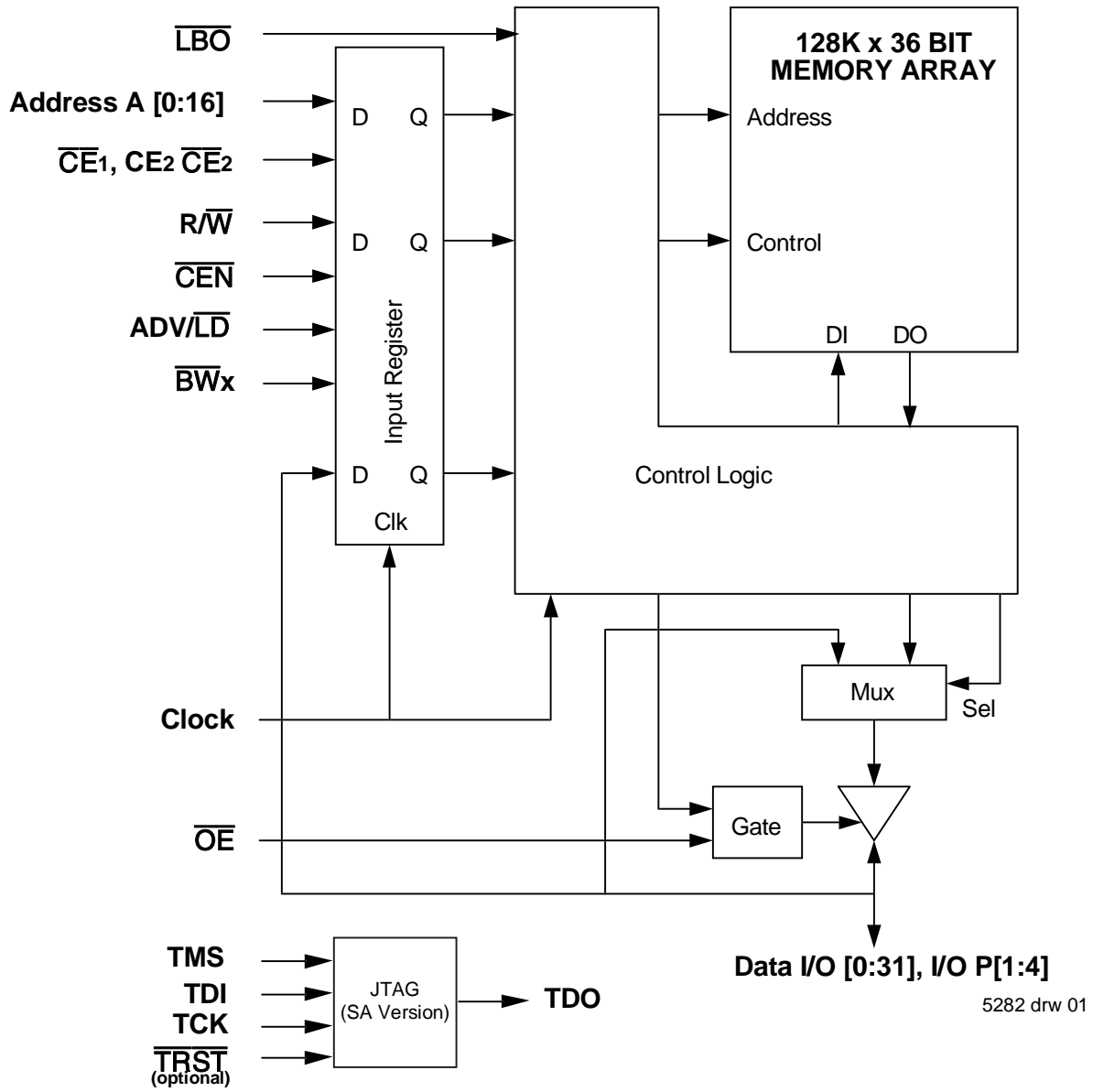

Recommended Operating Temperature and Supply Voltage

| Grade | Temperature ⁽¹⁾ | V _{SS} | V _{DD} | V _{DDQ} |
|------------|----------------------------|-----------------|-----------------|------------------|
| Commercial | 0°C to +70°C | 0V | 3.3V±5% | 3.3V±5% |
| Industrial | -40°C to +85°C | 0V | 3.3V±5% | 3.3V±5% |

NOTES:

5282 tbl 05

1. T_A is the "instant on" case temperature.

Pin Configuration — 128K x 36

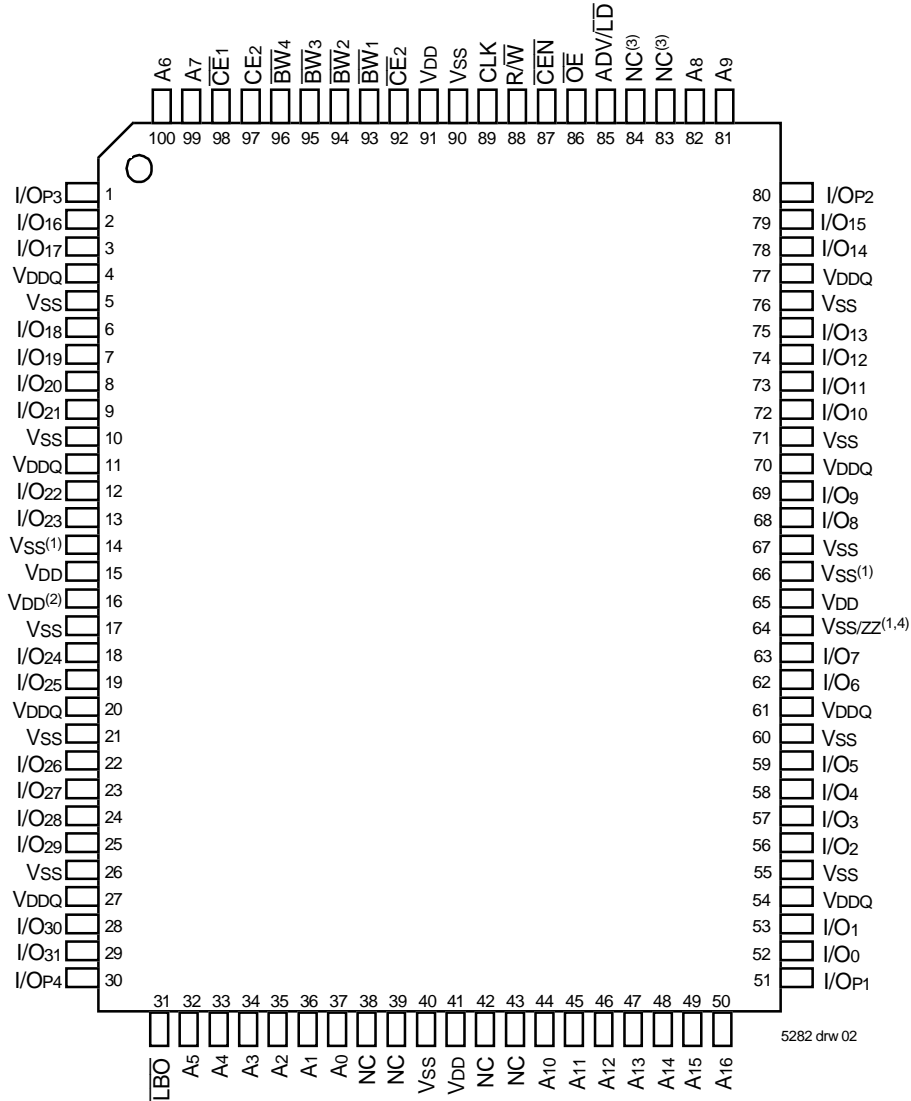

5282 drw 02

Top View 100 TQFP

NOTES:

1. Pins 14, 64, and 66 do not have to be connected directly to V_{SS} as long as the input voltage is $\leq V_{IH}$.
2. Pin 16 does not have to be connected directly to V_{DD} as long as the input voltage is $\geq V_{IH}$.
3. Pins 83 and 84 are reserved for future 8M and 16M respectively.
4. Pin 64 supports ZZ (sleep mode) for the latest die revisions.

Pin Configuration — 256K x 18

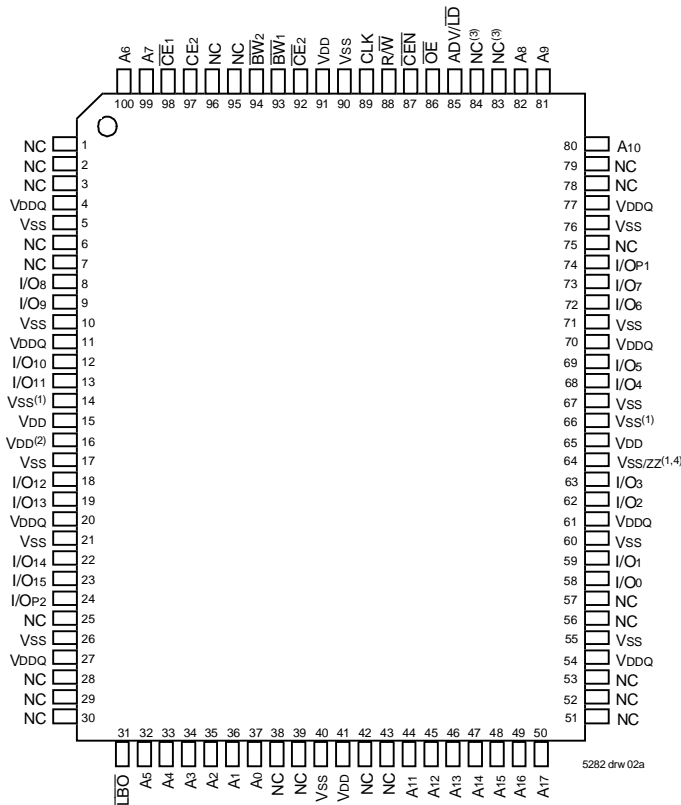

Top View 100 TQFP

NOTES:

1. Pins 14, 64, and 66 do not have to be connected directly to Vss as long as the input voltage is $\leq V_{IL}$.
2. Pin 16 does not have to be connected directly to VDD as long as the input voltage is $\geq V_{IH}$.
3. Pins 83 and 84 are reserved for future 8M and 16M respectively.
4. Pin 64 supports ZZ (sleep mode) for the latest die revisions.

100 TQFP Capacitance⁽¹⁾ (TA = +25°C, F = 1.0MHZ)

| Symbol | Parameter ⁽¹⁾ | Conditions | Max. | Unit |
|------------------|--------------------------|------------------------|------|------|
| C _{IN} | Input Capacitance | V _{IN} = 3dV | 5 | pF |
| C _{I/O} | I/O Capacitance | V _{OUT} = 3dV | 7 | pF |

5282 tbl 07

119 BGA Capacitance⁽¹⁾ (TA = +25°C, F = 1.0MHZ)

| Symbol | Parameter ⁽¹⁾ | Conditions | Max. | Unit |
|------------------|--------------------------|------------------------|------|------|
| C _{IN} | Input Capacitance | V _{IN} = 3dV | TBD | pF |
| C _{I/O} | I/O Capacitance | V _{OUT} = 3dV | TBD | pF |

5282 tbl 07b

NOTE:

1. This parameter is guaranteed by device characterization, but not production tested.

Absolute Maximum Ratings⁽¹⁾

| Symbol | Rating | Commercial & Industrial Values | Unit |
|------------------------------------|--------------------------------------|---------------------------------|------|
| V _{TERM} ⁽²⁾ | Terminal Voltage with Respect to GND | -0.5 to +4.6 | V |
| V _{TERM} ^(3,6) | Terminal Voltage with Respect to GND | -0.5 to V _{DD} | V |
| V _{TERM} ^(4,6) | Terminal Voltage with Respect to GND | -0.5 to V _{DD} + 0.5 | V |
| V _{TERM} ^(5,6) | Terminal Voltage with Respect to GND | -0.5 to V _{VDDQ} + 0.5 | V |
| T _A ⁽⁷⁾ | Commercial Operating Temperature | -0 to +70 | °C |
| | Industrial Operating Temperature | -40 to +85 | °C |
| T _{BIAS} | Temperature Under Bias | -55 to +125 | °C |
| T _{STG} | Storage Temperature | -55 to +125 | °C |
| P _T | Power Dissipation | 2.0 | W |
| I _{OUT} | DC Output Current | 50 | mA |

NOTES:

5282 tbl 06

1. Stresses greater than those listed under ABSOLUTE MAXIMUM RATINGS may cause permanent damage to the device. This is a stress rating only and functional operation of the device at these or any other conditions above those indicated in the operational sections of this specification is not implied. Exposure to absolute maximum rating conditions for extended periods may affect reliability.
2. VDD terminals only.
3. VDDQ terminals only.
4. Input terminals only.
5. I/O terminals only.
6. This is a steady-state DC parameter that applies after the power supply has reached its nominal operating value. Power sequencing is not necessary; however, the voltage on any input or I/O pin cannot exceed VDDQ during power supply ramp up.
7. T_A is the "instant on" case temperature.

119 BGA Capacitance⁽¹⁾ (TA = +25°C, F = 1.0MHZ)

| Symbol | Parameter ⁽¹⁾ | Conditions | Max. | Unit |
|------------------|--------------------------|------------------------|------|------|
| C _{IN} | Input Capacitance | V _{IN} = 3dV | 7 | pF |
| C _{I/O} | I/O Capacitance | V _{OUT} = 3dV | 7 | pF |

5282 tbl 07a

Pin Configuration — 128K x 36, 119 BGA

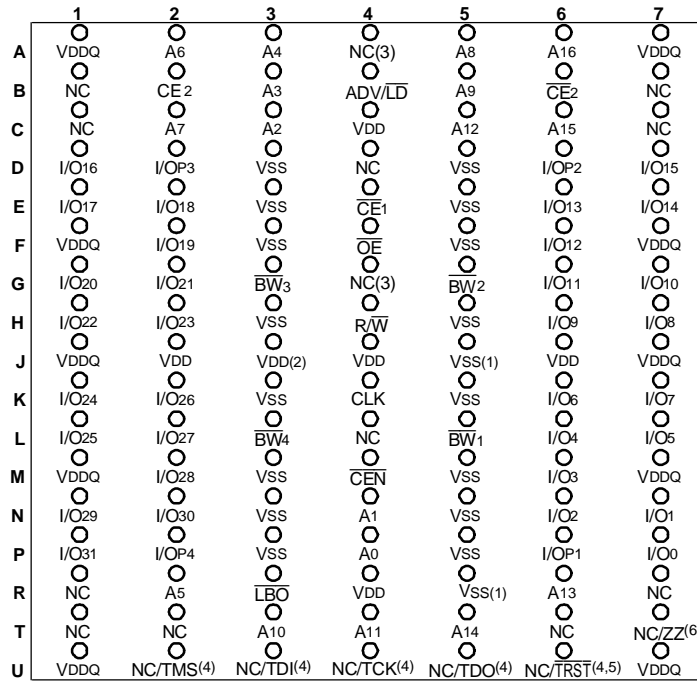

5282 drw 13A

Top View

Pin Configuration - 256K x 18, 119 BGA

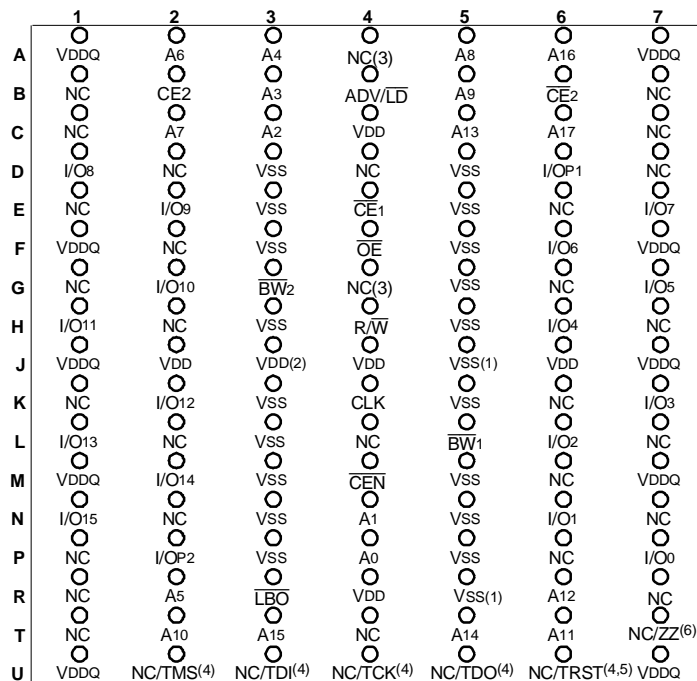

5282 drw 13B

Top View

NOTES:

- R5 and J5 do not have to be directly connected to Vss as long as the input voltage is $\leq V_{IL}$.
- J3 does not have to be directly connected directly to VDD as long as the input voltage is $\geq V_{IH}$.
- G4 and A4 are reserved for future 8M and 16M respectively.
- These pins are NC for the "S" version and the JTAG signal listed for the "SA" version.
- TRST is offered as an optional JTAG reset if requested in the application. If not needed, can be left floating and will internally be pulled to VDD.
- Pin T7 supports ZZ (sleep mode) for the latest die revisions.

Pin Configuration — 128K x 36, 165 fBGA

| | 1 | 2 | 3 | 4 | 5 | 6 | 7 | 8 | 9 | 10 | 11 |
|---|--------------------|--------------------|-------------------|-------------------|--|-------------------|-----------------------|----------------------|-------------------|-------|----------------------|
| A | NC ⁽³⁾ | A7 | \overline{CE}_1 | \overline{BW}_3 | \overline{BW}_2 | \overline{CE}_2 | \overline{CEN} | ADV/ \overline{LD} | NC ⁽³⁾ | A8 | NC |
| B | NC | A6 | CE2 | \overline{BW}_4 | \overline{BW}_1 | CLK | R/ \overline{W} | \overline{OE} | NC ⁽³⁾ | A9 | NC ⁽³⁾ |
| C | I/Op3 | NC | VDDQ | VSS | VSS | VSS | VSS | VSS | VDDQ | NC | I/Op2 |
| D | I/O17 | I/O16 | VDDQ | VDD | VSS | VSS | VSS | VDD | VDDQ | I/O15 | I/O14 |
| E | I/O19 | I/O18 | VDDQ | VDD | VSS | VSS | VSS | VDD | VDDQ | I/O13 | I/O12 |
| F | I/O21 | I/O20 | VDDQ | VDD | VSS | VSS | VSS | VDD | VDDQ | I/O11 | I/O10 |
| G | I/O23 | I/O22 | VDDQ | VDD | VSS | VSS | VSS | VDD | VDDQ | I/O9 | I/O8 |
| H | VSS ⁽¹⁾ | VDD ⁽²⁾ | NC | VDD | VSS | VSS | VSS | VDD | NC | NC | NC/ZZ ⁽⁶⁾ |
| J | I/O25 | I/O24 | VDDQ | VDD | VSS | VSS | VSS | VDD | VDDQ | I/O7 | I/O6 |
| K | I/O27 | I/O26 | VDDQ | VDD | VSS | VSS | VSS | VDD | VDDQ | I/O5 | I/O4 |
| L | I/O29 | I/O28 | VDDQ | VDD | VSS | VSS | VSS | VDD | VDDQ | I/O3 | I/O2 |
| M | I/O31 | I/O30 | VDDQ | VDD | VSS | VSS | VSS | VDD | VDDQ | I/O1 | I/O0 |
| N | I/Op4 | NC | VDDQ | VSS | NC/ \overline{TRST} ^(4,5) | NC | VSS ⁽¹⁾ | VSS | VDDQ | NC | I/Op1 |
| P | NC | NC ⁽³⁾ | A5 | A2 | NC/TDI ⁽⁴⁾ | A1 | NC/TDO ⁽⁴⁾ | A10 | A13 | A14 | NC |
| R | \overline{LB}_0 | NC ⁽³⁾ | A4 | A3 | NC/TMS ⁽⁴⁾ | A0 | NC/TCK ⁽⁴⁾ | A11 | A12 | A15 | A16 |

5282 tbl 25

Pin Configuration - 256K x 18, 165 fBGA

| | 1 | 2 | 3 | 4 | 5 | 6 | 7 | 8 | 9 | 10 | 11 |
|---|--------------------|--------------------|-------------------|-------------------|--|-------------------|-----------------------|----------------------|-------------------|------|----------------------|
| A | NC ⁽³⁾ | A7 | \overline{CE}_1 | \overline{BW}_2 | NC | \overline{CE}_2 | \overline{CEN} | ADV/ \overline{LD} | NC ⁽³⁾ | A8 | A10 |
| B | NC | A6 | CE2 | NC | \overline{BW}_1 | CLK | R/ \overline{W} | \overline{OE} | NC ⁽³⁾ | A9 | NC ⁽³⁾ |
| C | NC | NC | VDDQ | VSS | VSS | VSS | VSS | VSS | VDDQ | NC | I/Op1 |
| D | NC | I/O8 | VDDQ | VDD | VSS | VSS | VSS | VDD | VDDQ | NC | I/O7 |
| E | NC | I/O9 | VDDQ | VDD | VSS | VSS | VSS | VDD | VDDQ | NC | I/O6 |
| F | NC | I/O10 | VDDQ | VDD | VSS | VSS | VSS | VDD | VDDQ | NC | I/O5 |
| G | NC | I/O11 | VDDQ | VDD | VSS | VSS | VSS | VDD | VDDQ | NC | I/O4 |
| H | VSS ⁽¹⁾ | VDD ⁽²⁾ | NC | VDD | VSS | VSS | VSS | VDD | NC | NC | NC/ZZ ⁽⁶⁾ |
| J | I/O12 | NC | VDDQ | VDD | VSS | VSS | VSS | VDD | VDDQ | I/O3 | NC |
| K | I/O13 | NC | VDDQ | VDD | VSS | VSS | VSS | VDD | VDDQ | I/O2 | NC |
| L | I/O14 | NC | VDDQ | VDD | VSS | VSS | VSS | VDD | VDDQ | I/O1 | NC |
| M | I/O15 | NC | VDDQ | VDD | VSS | VSS | VSS | VDD | VDDQ | I/O0 | NC |
| N | I/Op2 | NC | VDDQ | VSS | NC/ \overline{TRST} ^(4,5) | NC | VSS ⁽¹⁾ | VSS | VDDQ | NC | NC |
| P | NC | NC ⁽³⁾ | A5 | A2 | NC/TDI ⁽⁴⁾ | A1 | NC/TDO ⁽⁴⁾ | A11 | A14 | A15 | NC |
| R | \overline{LB}_0 | NC ⁽³⁾ | A4 | A3 | NC/TMS ⁽⁴⁾ | A0 | NC/TCK ⁽⁴⁾ | A12 | A13 | A16 | A17 |

5282 tbl 25a

NOTES:

- H1 and N7 do not have to be directly connected to VSS as long as the input voltage is $\leq V_{IL}$.
- H2 does not have to be directly connected directly to VDD as long as the input voltage is $\geq V_{IH}$.
- A9, B9, B11, A1, R2, and P2 are reserved for future 9M, 18M, 36M, 72M, 144M, and 288M respectively.
- These pins are NC for the "S" version and the JTAG signal listed for the "SA" version.
- \overline{TRST} is offered as an optional JTAG reset if requested in the application. If not needed, can be left floating and will internally be pulled to VDD.
- Pin H11 supports ZZ (sleep mode) for the latest die revisions.

Synchronous Truth Table (1)

| \overline{CEN} | R/W | \overline{CE}_1 , $\overline{CE}_2^{(6)}$ | ADV/LD | \overline{BW}_x | ADDRESS USED | PREVIOUS CYCLE | CURRENT CYCLE | I/O (One cycle later) |
|------------------|-----|--|--------|-------------------|--------------|-----------------------------|---|--------------------------|
| L | L | L | L | Valid | External | X | LOAD WRITE | D ⁽⁷⁾ |
| L | H | L | L | X | External | X | LOAD READ | Q ⁽⁷⁾ |
| L | X | X | H | Valid | Internal | LOAD WRITE / BURST WRITE | BURST WRITE (Advance burst counter) ⁽²⁾ | D ⁽⁷⁾ |
| L | X | X | H | X | Internal | LOAD READ / BURST READ | BURST READ (Advance burst counter) ⁽²⁾ | Q ⁽⁷⁾ |
| L | X | H | L | X | X | X | DESELECT or STOP ⁽³⁾ | HIZ |
| L | X | X | H | X | X | DESELECT / NOOP | NOOP | HIZ |
| H | X | X | X | X | X | X | SUSPEND ⁽⁴⁾ | Previous Value |

5282 tbl 08

NOTES:

- L = V_{IL}, H = V_{IH}, X = Don't Care.
- When ADV/LD signal is sampled high, the internal burst counter is incremented. The R/W signal is ignored when the counter is advanced. Therefore the nature of the burst cycle (Read or Write) is determined by the status of the R/W signal when the first address is loaded at the beginning of the burst cycle.
- Deselect cycle is initiated when either \overline{CE}_1 , or \overline{CE}_2 is sampled high or \overline{CE}_2 is sampled low) and ADV/LD is sampled low at rising edge of clock. The data bus will tri-state one cycle after deselect is initiated.
- When \overline{CEN} is sampled high at the rising edge of clock, that clock edge is blocked from propagating through the part. The state of all the internal registers and the I/Os remains unchanged.
- To select the chip requires $\overline{CE}_1 = L$, $\overline{CE}_2 = L$ and $CE_2 = H$ on these chip enable pins. The chip is deselected if any one of the chip enables is false.
- Device Outputs are ensured to be in High-Z during device power-up.
- Q - data read from the device, D - data written to the device.

Partial Truth Table for Writes (1)

| OPERATION | R/W | \overline{BW}_1 | \overline{BW}_2 | $\overline{BW}_3^{(3)}$ | $\overline{BW}_4^{(3)}$ |
|---|-----|-------------------|-------------------|-------------------------|-------------------------|
| READ | H | X | X | X | X |
| WRITE ALL BYTES | L | L | L | L | L |
| WRITE BYTE 1 (I/O[0:7], I/OP1) ⁽²⁾ | L | L | H | H | H |
| WRITE BYTE 2 (I/O[8:15], I/OP2) ⁽²⁾ | L | H | L | H | H |
| WRITE BYTE 3 (I/O[16:23], I/OP3) ^(2,3) | L | H | H | L | H |
| WRITE BYTE 4 (I/O[24:31], I/OP4) ^(2,3) | L | H | H | H | L |
| NO WRITE | L | H | H | H | H |

5282 tbl 09

NOTES:

- L = V_{IL}, H = V_{IH}, X = Don't Care.
- Multiple bytes may be selected during the same cycle.
- N/A for x18 configuration.

Interleaved Burst Sequence Table ($\overline{LBO} = V_{DD}$)

| | Sequence 1 | | Sequence 2 | | Sequence 3 | | Sequence 4 | |
|-------------------------------|------------|----|------------|----|------------|----|------------|----|
| | A1 | A0 | A1 | A0 | A1 | A0 | A1 | A0 |
| First Address | 0 | 0 | 0 | 1 | 1 | 0 | 1 | 1 |
| Second Address | 0 | 1 | 0 | 0 | 1 | 1 | 1 | 0 |
| Third Address | 1 | 0 | 1 | 1 | 0 | 0 | 0 | 1 |
| Fourth Address ⁽¹⁾ | 1 | 1 | 1 | 0 | 0 | 1 | 0 | 0 |

5282 tbl 10

NOTE:

- Upon completion of the Burst sequence the counter wraps around to its initial state and continues counting.

Linear Burst Sequence Table ($\overline{LBO}=V_{ss}$)

| | Sequence 1 | | Sequence 2 | | Sequence 3 | | Sequence 4 | |
|-------------------------------|------------|----|------------|----|------------|----|------------|----|
| | A1 | A0 | A1 | A0 | A1 | A0 | A1 | A0 |
| First Address | 0 | 0 | 0 | 1 | 1 | 0 | 1 | 1 |
| Second Address | 0 | 1 | 1 | 0 | 1 | 1 | 0 | 0 |
| Third Address | 1 | 0 | 1 | 1 | 0 | 0 | 0 | 1 |
| Fourth Address ⁽¹⁾ | 1 | 1 | 0 | 0 | 0 | 1 | 1 | 0 |

5282 tbl 11

NOTE:

1. Upon completion of the Burst sequence the counter wraps around to its initial state and continues counting.

Functional Timing Diagram (1)

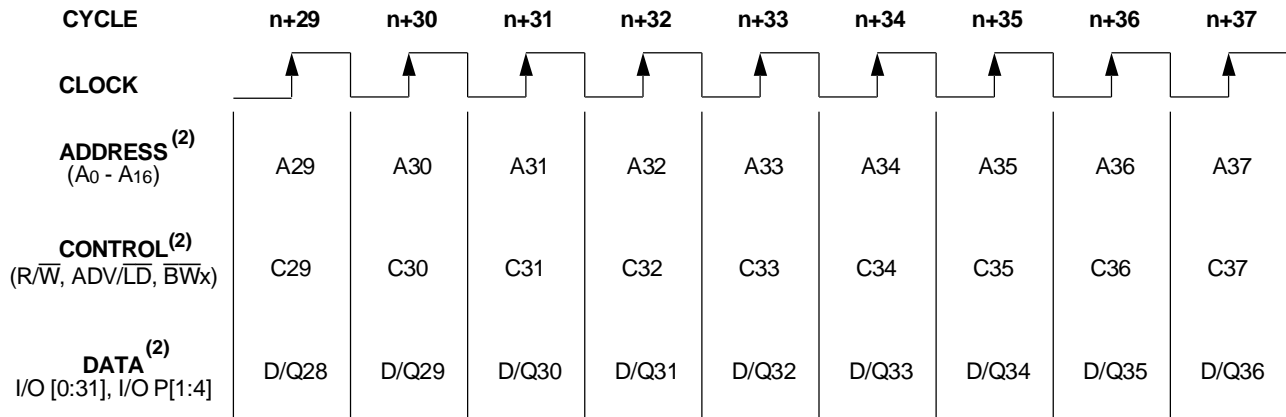

5282 drw 03

NOTES:

1. This assumes \overline{CEN} , $\overline{CE1}$, $CE2$ and $\overline{CE2}$ are all true.
2. All Address, Control and Data_In are only required to meet set-up and hold time with respect to the rising edge of clock. Data_Out is valid after a clock-to-data delay from the rising edge of clock.

Device Operation - Showing Mixed Load, Burst, Deselect and NOOP Cycles ⁽²⁾

| Cycle | Address | R/ \bar{W} | ADV/ \bar{LD} | $\bar{CE}_1^{(1)}$ | \bar{CEN} | \bar{BW}_x | \bar{OE} | I/O | Comments |
|-------|---------|--------------|-----------------|--------------------|-------------|--------------|------------|------|------------------|
| n | A0 | H | L | L | L | X | X | D1 | Load read |
| n+1 | X | X | H | X | L | X | L | Q0 | Burst read |
| n+2 | A1 | H | L | L | L | X | L | Q0+1 | Load read |
| n+3 | X | X | L | H | L | X | L | Q1 | Deselect or STOP |
| n+4 | X | X | H | X | L | X | X | Z | NOOP |
| n+5 | A2 | H | L | L | L | X | X | Z | Load read |
| n+6 | X | X | H | X | L | X | L | Q2 | Burst read |
| n+7 | X | X | L | H | L | X | L | Q2+1 | Deselect or STOP |
| n+8 | A3 | L | L | L | L | L | X | Z | Load write |
| n+9 | X | X | H | X | L | L | X | D3 | Burst write |
| n+10 | A4 | L | L | L | L | L | X | D3+1 | Load write |
| n+11 | X | X | L | H | L | X | X | D4 | Deselect or STOP |
| n+12 | X | X | H | X | L | X | X | Z | NOOP |
| n+13 | A5 | L | L | L | L | L | X | Z | Load write |
| n+14 | A6 | H | L | L | L | X | X | D5 | Load read |
| n+15 | A7 | L | L | L | L | L | L | Q6 | Load write |
| n+16 | X | X | H | X | L | L | X | D7 | Burst write |
| n+17 | A8 | H | L | L | L | X | X | D7+1 | Load read |
| n+18 | X | X | H | X | L | X | L | Q8 | Burst read |
| n+19 | A9 | L | L | L | L | L | L | Q8+1 | Load write |

5282 tbl 12

NOTES:

- \bar{CE}_2 timing transition is identical to \bar{CE}_1 signal. \bar{CE}_2 timing transition is identical but inverted to the \bar{CE}_1 and \bar{CE}_2 signals.
- H = High; L = Low; X = Don't Care; Z = High Impedence.

Read Operation (1)

| Cycle | Address | R \bar{W} | ADV/ $\bar{L}\bar{D}$ | $\bar{C}\bar{E}_1^{(2)}$ | $\bar{C}\bar{E}\bar{N}$ | $\bar{B}\bar{W}x$ | $\bar{O}\bar{E}$ | I/O | Comments |
|-------|----------------|-------------|-----------------------|--------------------------|-------------------------|-------------------|------------------|----------------|---|
| n | A ₀ | H | L | L | L | X | X | X | Address and Control meet setup |
| n+1 | X | X | X | X | X | X | L | Q ₀ | Contents of Address A ₀ Read Out |

5282 tbl 13

NOTES:

1. H = High; L = Low; X = Don't Care; Z = High Impedance.
2. $\bar{C}\bar{E}_2$ timing transition is identical to $\bar{C}\bar{E}_1$ signal. $\bar{C}\bar{E}_2$ timing transition is identical but inverted to the $\bar{C}\bar{E}_1$ and $\bar{C}\bar{E}_2$ signals.

Burst Read Operation (1)

| Cycle | Address | R \bar{W} | ADV/ $\bar{L}\bar{D}$ | $\bar{C}\bar{E}_1^{(2)}$ | $\bar{C}\bar{E}\bar{N}$ | $\bar{B}\bar{W}x$ | $\bar{O}\bar{E}$ | I/O | Comments |
|-------|----------------|-------------|-----------------------|--------------------------|-------------------------|-------------------|------------------|------------------|--|
| n | A ₀ | H | L | L | L | X | X | X | Address and Control meet setup |
| n+1 | X | X | H | X | L | X | L | Q ₀ | Address A ₀ Read Out, Inc. Count |
| n+2 | X | X | H | X | L | X | L | Q ₀₊₁ | Address A ₀₊₁ Read Out, Inc. Count |
| n+3 | X | X | H | X | L | X | L | Q ₀₊₂ | Address A ₀₊₂ Read Out, Inc. Count |
| n+4 | X | X | H | X | L | X | L | Q ₀₊₃ | Address A ₀₊₃ Read Out, Load A ₁ |
| n+5 | A ₁ | H | L | L | L | X | L | Q ₀ | Address A ₀ Read Out, Inc. Count |
| n+6 | X | X | H | X | L | X | L | Q ₁ | Address A ₁ Read Out, Inc. Count |
| n+7 | A ₂ | H | L | L | L | X | L | Q ₁₊₁ | Address A ₁₊₁ Read Out, Load A ₂ |

5282 tbl 14

NOTES:

1. H = High; L = Low; X = Don't Care; Z = High Impedance.
2. $\bar{C}\bar{E}_2$ timing transition is identical to $\bar{C}\bar{E}_1$ signal. $\bar{C}\bar{E}_2$ timing transition is identical but inverted to the $\bar{C}\bar{E}_1$ and $\bar{C}\bar{E}_2$ signals.

Write Operation (1)

| Cycle | Address | R \bar{W} | ADV/ $\bar{L}\bar{D}$ | $\bar{C}\bar{E}_1^{(2)}$ | $\bar{C}\bar{E}\bar{N}$ | $\bar{B}\bar{W}x$ | $\bar{O}\bar{E}$ | I/O | Comments |
|-------|----------------|-------------|-----------------------|--------------------------|-------------------------|-------------------|------------------|----------------|---------------------------------|
| n | A ₀ | L | L | L | L | L | X | X | Address and Control meet setup |
| n+1 | X | X | X | X | L | X | X | D ₀ | Write to Address A ₀ |

5282 tbl 15

NOTES:

1. H = High; L = Low; X = Don't Care; Z = High Impedance.
2. $\bar{C}\bar{E}_2$ timing transition is identical to $\bar{C}\bar{E}_1$ signal. $\bar{C}\bar{E}_2$ timing transition is identical but inverted to the $\bar{C}\bar{E}_1$ and $\bar{C}\bar{E}_2$ signals.

Burst Write Operation (1)

| Cycle | Address | R \bar{W} | ADV/ $\bar{L}\bar{D}$ | $\bar{C}\bar{E}_1^{(2)}$ | $\bar{C}\bar{E}\bar{N}$ | $\bar{B}\bar{W}x$ | $\bar{O}\bar{E}$ | I/O | Comments |
|-------|----------------|-------------|-----------------------|--------------------------|-------------------------|-------------------|------------------|------------------|---|
| n | A ₀ | L | L | L | L | L | X | X | Address and Control meet setup |
| n+1 | X | X | H | X | L | L | X | D ₀ | Address A ₀ Write, Inc. Count |
| n+2 | X | X | H | X | L | L | X | D ₀₊₁ | Address A ₀₊₁ Write, Inc. Count |
| n+3 | X | X | H | X | L | L | X | D ₀₊₂ | Address A ₀₊₂ Write, Inc. Count |
| n+4 | X | X | H | X | L | L | X | D ₀₊₃ | Address A ₀₊₃ Write, Load A ₁ |
| n+5 | A ₁ | L | L | L | L | L | X | D ₀ | Address A ₀ Write, Inc. Count |
| n+6 | X | X | H | X | L | L | X | D ₁ | Address A ₁ Write, Inc. Count |
| n+7 | A ₂ | L | L | L | L | L | X | D ₁₊₁ | Address A ₁₊₁ Write, Load A ₂ |

5282 tbl 16

NOTES:

1. H = High; L = Low; X = Don't Care; Z = High Impedance.
2. $\bar{C}\bar{E}_2$ timing transition is identical to $\bar{C}\bar{E}_1$ signal. $\bar{C}\bar{E}_2$ timing transition is identical but inverted to the $\bar{C}\bar{E}_1$ and $\bar{C}\bar{E}_2$ signals.

Read Operation with Clock Enable Used ⁽¹⁾

| Cycle | Address | R/ \bar{W} | ADV/ \bar{LD} | $\bar{CE}_1^{(2)}$ | \bar{CEN} | BWx | \bar{OE} | I/O | Comments |
|-------|----------------|--------------|-----------------|--------------------|-------------|-----|------------|----------------|--|
| n | A ₀ | H | L | L | L | X | X | X | Address A ₀ and Control meet setup |
| n+1 | X | X | X | X | H | X | X | X | Clock n+1 Ignored |
| n+2 | A ₁ | H | L | L | L | X | L | Q ₀ | Address A ₀ Read out, Load A ₁ |
| n+3 | X | X | X | X | H | X | L | Q ₀ | Clock Ignored. Data Q ₀ is on the bus. |
| n+4 | X | X | X | X | H | X | L | Q ₀ | Clock Ignored. Data Q ₀ is on the bus. |
| n+5 | A ₂ | H | L | L | L | X | L | Q ₁ | Address A ₁ Read out, Load A ₂ |
| n+6 | A ₃ | H | L | L | L | X | L | Q ₂ | Address A ₂ Read out, Load A ₃ |
| n+7 | A ₄ | H | L | L | L | X | L | Q ₃ | Address A ₃ Read out, Load A ₄ |

5282 tbl 17

NOTES:

1. H = High; L = Low; X = Don't Care; Z = High Impedance.
2. \bar{CE}_2 timing transition is identical to \bar{CE}_1 signal. \bar{CE}_2 timing transition is identical but inverted to the \bar{CE}_1 and \bar{CE}_2 signals.

Write Operation with Clock Enable Used ⁽¹⁾

| Cycle | Address | R/ \bar{W} | ADV/ \bar{LD} | $\bar{CE}_1^{(2)}$ | \bar{CEN} | BWx | \bar{OE} | I/O | Comments |
|-------|----------------|--------------|-----------------|--------------------|-------------|-----|------------|----------------|---|
| n | A ₀ | L | L | L | L | L | X | X | Address A ₀ and Control meet setup. |
| n+1 | X | X | X | X | H | X | X | X | Clock n+1 Ignored. |
| n+2 | A ₁ | L | L | L | L | L | X | D ₀ | Write data D ₀ , Load A ₁ . |
| n+3 | X | X | X | X | H | X | X | X | Clock Ignored. |
| n+4 | X | X | X | X | H | X | X | X | Clock Ignored. |
| n+5 | A ₂ | L | L | L | L | L | X | D ₁ | Write Data D ₁ , Load A ₂ |
| n+6 | A ₃ | L | L | L | L | L | X | D ₂ | Write Data D ₂ , Load A ₃ |
| n+7 | A ₄ | L | L | L | L | L | X | D ₃ | Write Data D ₃ , Load A ₄ |

5282 tbl 18

NOTES:

1. H = High; L = Low; X = Don't Care; Z = High Impedance.
2. \bar{CE}_2 timing transition is identical to \bar{CE}_1 signal. \bar{CE}_2 timing transition is identical but inverted to the \bar{CE}_1 and \bar{CE}_2 signals.

Read Operation with Chip Enable Used (1)

| Cycle | Address | R/ \overline{W} | ADV/ \overline{LD} | $\overline{CE}_1^{(2)}$ | \overline{CEN} | \overline{BW}_x | \overline{OE} | I/O ⁽³⁾ | Comments |
|-------|----------------|-------------------|----------------------|-------------------------|------------------|-------------------|-----------------|--------------------|--|
| n | X | X | L | H | L | X | X | ? | Deselected. |
| n+1 | X | X | L | H | L | X | X | Z | Deselected. |
| n+2 | A ₀ | H | L | L | L | X | X | Z | Address A ₀ and Control meet setup. |
| n+3 | X | X | L | H | L | X | L | Q ₀ | Address A ₀ read out, Deselected. |
| n+4 | A ₁ | H | L | L | L | X | X | Z | Address A ₁ and Control meet setup. |
| n+5 | X | X | L | H | L | X | L | Q ₁ | Address A ₁ read out, Deselected. |
| n+6 | X | X | L | H | L | X | X | Z | Deselected. |
| n+7 | A ₂ | H | L | L | L | X | X | Z | Address A ₂ and Control meet setup. |
| n+8 | X | X | L | H | L | X | L | Q ₂ | Address A ₂ read out, Deselected. |
| n+9 | X | X | L | H | L | X | X | Z | Deselected. |

5282 tbl 19

NOTES:

1. H = High; L = Low; X = Don't Care; ? = Don't Know; Z = High Impedance.
2. \overline{CE}_2 timing transition is identical to \overline{CE}_1 signal. CE₂ timing transition is identical but inverted to the \overline{CE}_1 and \overline{CE}_2 signals.
3. Device outputs are ensured to be in High-Z during device power-up.

Write Operation with Chip Enable Used (1)

| Cycle | Address | R/ \overline{W} | ADV/ \overline{LD} | $\overline{CE}_1^{(2)}$ | \overline{CEN} | \overline{BW}_x | \overline{OE} | I/O | Comments |
|-------|----------------|-------------------|----------------------|-------------------------|------------------|-------------------|-----------------|----------------|---|
| n | X | X | L | H | L | X | X | ? | Deselected. |
| n+1 | X | X | L | H | L | X | X | Z | Deselected. |
| n+2 | A ₀ | L | L | L | L | L | X | Z | Address A ₀ and Control meet setup |
| n+3 | X | X | L | H | L | X | X | D ₀ | Data D ₀ Write In, Deselected. |
| n+4 | A ₁ | L | L | L | L | L | X | Z | Address A ₁ and Control meet setup |
| n+5 | X | X | L | H | L | X | X | D ₁ | Data D ₁ Write In, Deselected. |
| n+6 | X | X | L | H | L | X | X | Z | Deselected. |
| n+7 | A ₂ | L | L | L | L | L | X | Z | Address A ₂ and Control meet setup |
| n+8 | X | X | L | H | L | X | X | D ₂ | Data D ₂ Write In, Deselected. |
| n+9 | X | X | L | H | L | X | X | Z | Deselected. |

5282 tbl 20

NOTES:

1. H = High; L = Low; X = Don't Care; ? = Don't Know; Z = High Impedance.
2. $\overline{CE} = L$ is defined as $\overline{CE}_1 = L$, $\overline{CE}_2 = L$ and CE₂ = H. $\overline{CE} = H$ is defined as $\overline{CE}_1 = H$, $\overline{CE}_2 = H$ or CE₂ = L.

DC Electrical Characteristics Over the Operating Temperature and Supply Voltage Range ($V_{DD} = 3.3V \pm 5\%$)

| Symbol | Parameter | Test Conditions | Min. | Max. | Unit |
|-----------|---|--|------|------|---------|
| $ I_{L} $ | Input Leakage Current | $V_{DD} = \text{Max.}, V_{IN} = 0V \text{ to } V_{DD}$ | — | 5 | μA |
| $ I_{L} $ | \overline{LBO} , JTAG and ZZ Input Leakage Current ⁽¹⁾ | $V_{DD} = \text{Max.}, V_{IN} = 0V \text{ to } V_{DD}$ | — | 30 | μA |
| $ I_{O} $ | Output Leakage Current | $V_{OUT} = 0V \text{ to } V_{CC}$ | — | 5 | μA |
| V_{OL} | Output Low Voltage | $I_{OL} = +8mA, V_{DD} = \text{Min.}$ | — | 0.4 | V |
| V_{OH} | Output High Voltage | $I_{OH} = -8mA, V_{DD} = \text{Min.}$ | 2.4 | — | V |

5282 tbl 21

NOTE:

1. The \overline{LBO} , JTAG and ZZ pins will be internally pulled to V_{DD} and ZZ will be internally pulled to V_{SS} if it is not actively driven in the application.

DC Electrical Characteristics Over the Operating Temperature and Supply Voltage Range ⁽¹⁾ ($V_{DD} = 3.3V \pm 5\%$)

| Symbol | Parameter | Test Conditions | 7.5ns | 8ns | | 8.5ns | | Unit |
|-----------|------------------------------------|--|------------|-------|-----|-------|-----|------|
| | | | Com'l Only | Com'l | Ind | Com'l | Ind | |
| I_{DD} | Operating Power Supply Current | Device Selected, Outputs Open, $ADV/\overline{LD} = X, V_{DD} = \text{Max.}, V_{IN} \geq V_{IH} \text{ or } \leq V_{IL}, f = f_{MAX}^{(2)}$ | 275 | 250 | 260 | 225 | 235 | mA |
| I_{SB1} | CMOS Standby Power Supply Current | Device Deselected, Outputs Open, $V_{DD} = \text{Max.}, V_{IN} \geq V_{HD} \text{ or } \leq V_{LD}, f = 0^{(2,3)}$ | 40 | 40 | 45 | 40 | 45 | mA |
| I_{SB2} | Clock Running Power Supply Current | Device Deselected, Outputs Open, $V_{DD} = \text{Max.}, V_{IN} \geq V_{HD} \text{ or } \leq V_{LD}, f = f_{MAX}^{(2,3)}$ | 105 | 100 | 110 | 95 | 105 | mA |
| I_{SB3} | Idle Power Supply Current | Device Selected, Outputs Open, $\overline{CEN} \geq V_{IH}, V_{DD} = \text{Max.}, V_{IN} \geq V_{HD} \text{ or } \leq V_{LD}, f = f_{MAX}^{(2,3)}$ | 40 | 40 | 45 | 40 | 45 | mA |

5282 tbl 22

NOTES:

- All values are maximum guaranteed values.
- At $f = f_{MAX}$, inputs are cycling at the maximum frequency of read cycles of 1/tcvc; $f=0$ means no input lines are changing.
- For I/Os $V_{HD} = V_{DDQ} - 0.2V, V_{LD} = 0.2V$. For other inputs $V_{HD} = V_{DD} - 0.2V, V_{LD} = 0.2V$.

AC Test Loads

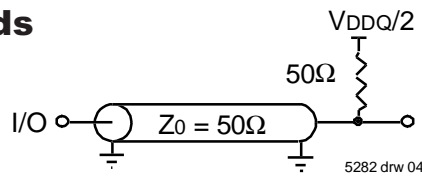

Figure 1. AC Test Load

AC Test Conditions ($V_{DDQ} = 3.3V$)

| | |
|-------------------------------|----------|
| Input Pulse Levels | 0 to 3V |
| Input Rise/Fall Times | 2ns |
| Input Timing Reference Levels | 1.5V |
| Output Reference Levels | 1.5V |
| Output Load | Figure 1 |

5282 tbl 23

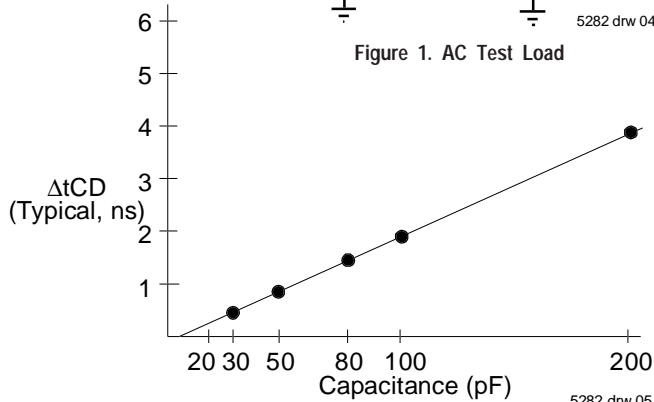

Figure 2. Lumped Capacitive Load, Typical Derating

AC Electrical Characteristics (VDD = 3.3V +/-5%, Commercial and Industrial Temperature Ranges)

| Symbol | Parameter | 7.5ns ⁽⁵⁾ | | 8ns | | 8.5ns | | Unit |
|-------------------------------------|--|----------------------|------|------|------|-------|------|------|
| | | Min. | Max. | Min. | Max. | Min. | Max. | |
| t _{CYC} | Clock Cycle Time | 10 | — | 10.5 | — | 11 | — | ns |
| t _{CH} ⁽¹⁾ | Clock High Pulse Width | 2.5 | — | 2.7 | — | 3.0 | — | ns |
| t _{CL} ⁽¹⁾ | Clock Low Pulse Width | 2.5 | — | 2.7 | — | 3.0 | — | ns |
| Output Parameters | | | | | | | | |
| t _{CD} | Clock High to Valid Data | — | 7.5 | — | 8 | — | 8.5 | ns |
| t _{CO} | Clock High to Data Change | 2 | — | 2 | — | 2 | — | ns |
| t _{CLZ} ^(2,3,4) | Clock High to Output Active | 3 | — | 3 | — | 3 | — | ns |
| t _{CHZ} ^(2,3,4) | Clock High to Data High-Z | — | 5 | — | 5 | — | 5 | ns |
| t _{OE} | Output Enable Access Time | — | 5 | — | 5 | — | 5 | ns |
| t _{OLZ} ^(2,3) | Output Enable Low to Data Active | 0 | — | 0 | — | 0 | — | ns |
| t _{OHZ} ^(2,3) | Output Enable High to Data High-Z | — | 5 | — | 5 | — | 5 | ns |
| Set Up Times | | | | | | | | |
| t _{SE} | Clock Enable Setup Time | 2.0 | — | 2.0 | — | 2.0 | — | ns |
| t _{SA} | Address Setup Time | 2.0 | — | 2.0 | — | 2.0 | — | ns |
| t _{SD} | Data In Setup Time | 2.0 | — | 2.0 | — | 2.0 | — | ns |
| t _{SW} | Read/Write (R \bar{W}) Setup Time | 2.0 | — | 2.0 | — | 2.0 | — | ns |
| t _{ADV} | Advance/Load (ADV/ \bar{L} D) Setup Time | 2.0 | — | 2.0 | — | 2.0 | — | ns |
| t _{SC} | Chip Enable/Select Setup Time | 2.0 | — | 2.0 | — | 2.0 | — | ns |
| t _{SB} | Byte Write Enable ($\bar{B}Wx$) Setup Time | 2.0 | — | 2.0 | — | 2.0 | — | ns |
| Hold Times | | | | | | | | |
| t _{HE} | Clock Enable Hold Time | 0.5 | — | 0.5 | — | 0.5 | — | ns |
| t _{HA} | Address Hold Time | 0.5 | — | 0.5 | — | 0.5 | — | ns |
| t _{HD} | Data In Hold Time | 0.5 | — | 0.5 | — | 0.5 | — | ns |
| t _{HW} | Read/Write (R \bar{W}) Hold Time | 0.5 | — | 0.5 | — | 0.5 | — | ns |
| t _{HADV} | Advance/Load (ADV/ \bar{L} D) Hold Time | 0.5 | — | 0.5 | — | 0.5 | — | ns |
| t _{HC} | Chip Enable/Select Hold Time | 0.5 | — | 0.5 | — | 0.5 | — | ns |
| t _{HB} | Byte Write Enable ($\bar{B}Wx$) Hold Time | 0.5 | — | 0.5 | — | 0.5 | — | ns |

5282 tbl 24

NOTES:

1. Measured as HIGH above 0.6V_{DD0} and LOW below 0.4V_{DD0}.
2. Transition is measured ±200mV from steady-state.
3. These parameters are guaranteed with the AC load (Figure 1) by device characterization. They are not production tested.
4. To avoid bus contention, the output buffers are designed such that t_{CHZ} (device turn-off) is about 1ns faster than t_{CLZ} (device turn-on) at a given temperature and voltage. The specs as shown do not imply bus contention because t_{CLZ} is a Min. parameter that is worse case at totally different test conditions (0 deg. C, 3.465V) than t_{CHZ}, which is a Max. parameter (worse case at 70 deg. C, 3.135V).
5. Commercial temperature range only.

Timing Waveform of Read Cycle (1,2,3,4)

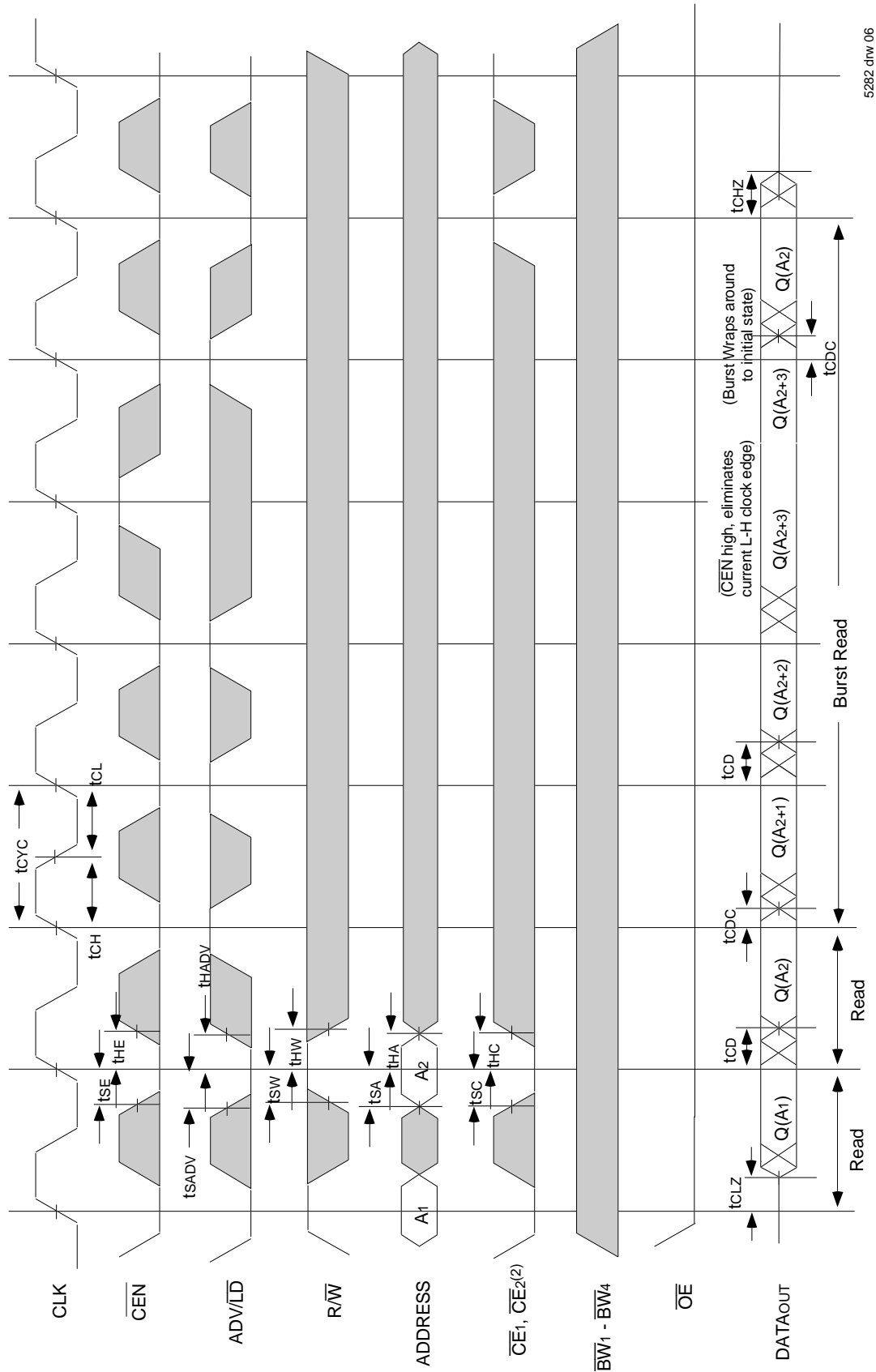

5282 drw 06

NOTES:

1. $Q(A_1)$ represents the first output from the external address A_1 . $Q(A_2)$ represents the first output from the external address A_2 . $Q(A_2+1)$ represents the next output data in the burst sequence of the base address A_2 , etc. where address bits A_0 and A_1 are advancing for the four word burst in the sequence defined by the state of the \overline{LBO} input.
2. CE_2 timing transitions are identical but inverted to the \overline{CE}_1 and \overline{CE}_2 signals. For example, when \overline{CE}_1 and \overline{CE}_2 are LOW on this waveform, CE_1 and CE_2 are HIGH.
3. Burst ends when new address and control are loaded into the SRAM by sampling $\overline{ADV/LD}$ LOW.
4. R/\overline{W} is don't care when the SRAM is bursting ($\overline{ADV/LD}$ sampled HIGH). The nature of the burst access (Read or Write) is fixed by the state of the R/\overline{W} signal when new address and control are loaded into the SRAM.

Timing Waveform of Write Cycles (1,2,3,4,5)

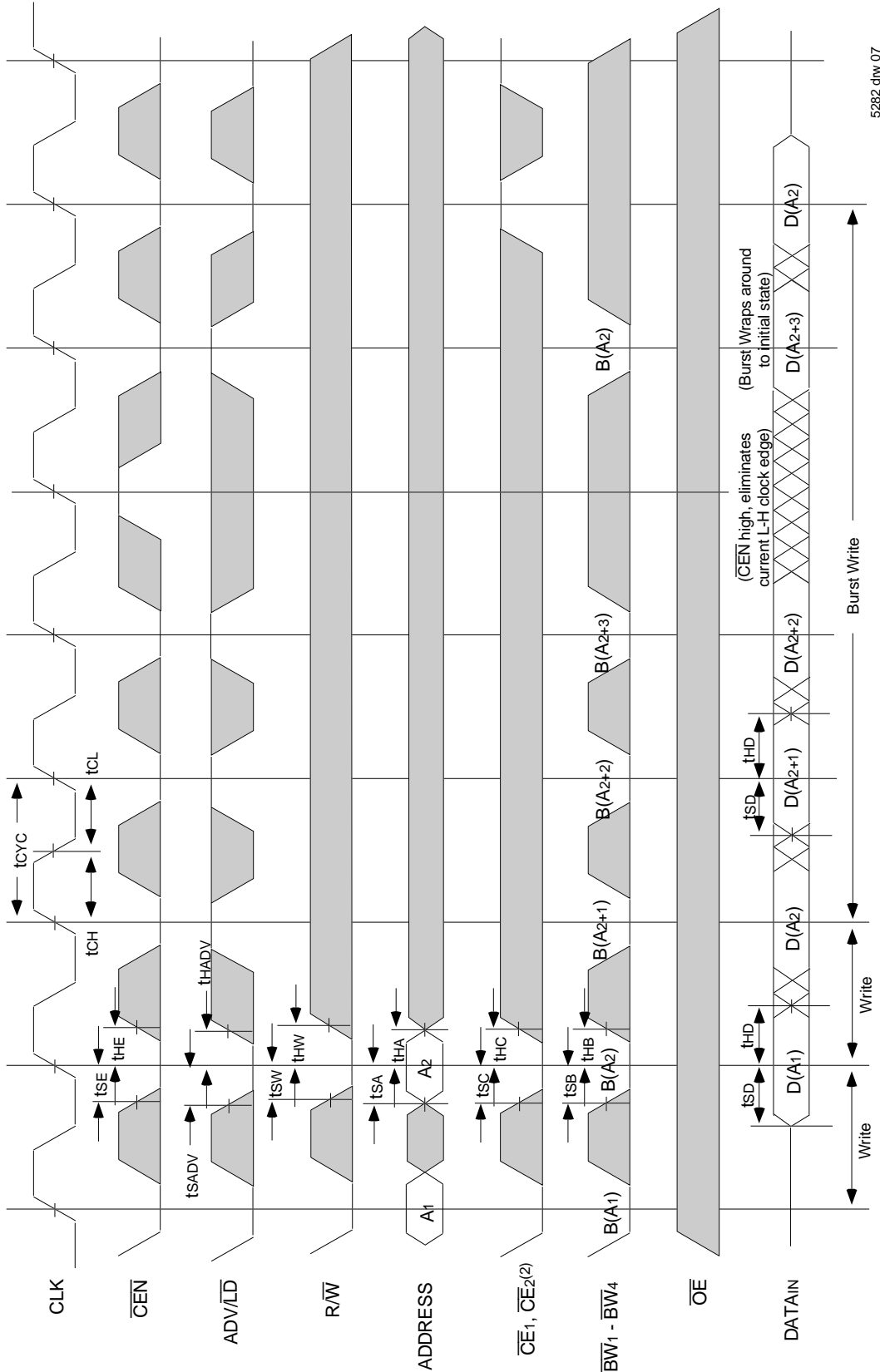

5282 dhw 07

NOTES:

1. D(A1) represents the first input to the external address A1. D(A2) represents the first input to the external address A2; D(A2+1) represents the next input data in the burst sequence of the base address A2, etc. where address bits A0 and A1 are advancing for the four word burst in the sequence defined by the state of the LBO input.
2. CE2 timing transitions are identical but inverted to the $\overline{CE1}$ and $\overline{CE2}$ signals. For example, when $\overline{CE1}$ and $\overline{CE2}$ are LOW on this waveform, CE2 is HIGH.
3. Burst ends when new address and control are loaded into the SRAM by sampling ADV/LD LOW.
4. R/W is don't care when the SRAM is bursting (ADV/LD sampled HIGH). The nature of the burst access (Read or Write) is fixed by the state of the $\overline{R/W}$ signal when new address and control are loaded into the SRAM.
5. Individual Byte Write signals (\overline{BWx}) must be valid on write and burst-write cycles. A write cycle is initiated when $\overline{R/W}$ signal is sampled LOW. The byte write information comes in one cycle before the actual data is presented to the SRAM.

Timing Waveform of Combined Read and Write Cycles (1,2,3)

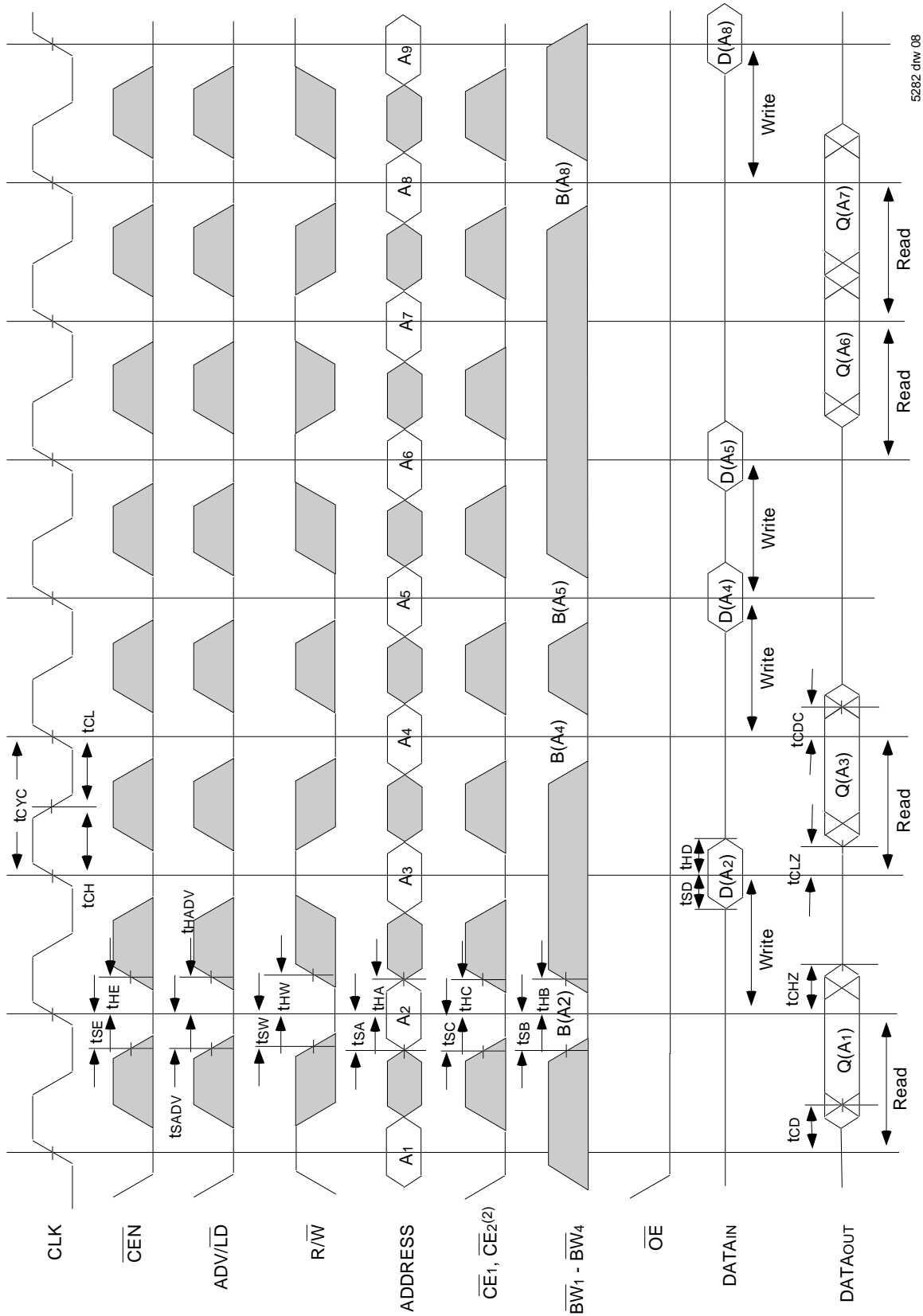

5282 d1w 08

NOTES:

1. Q(A1) represents the first output from the external address A1. D(A2) represents the input data to the SRAM corresponding to address A2.
2. CE2 timing transitions are identical but inverted to the CE1 and CE2 signals. For example, when CE1 and CE2 are LOW on this waveform, CE2 is HIGH.
3. Individual Byte Write signals (BWx) must be valid on all write and burst-write cycles. A write cycle is initiated when R/W signal is sampled LOW. The byte write information comes in one cycle before the actual data is presented to the SRAM.

Timing Waveform of $\overline{\text{CEN}}$ Operation (1,2,3,4)

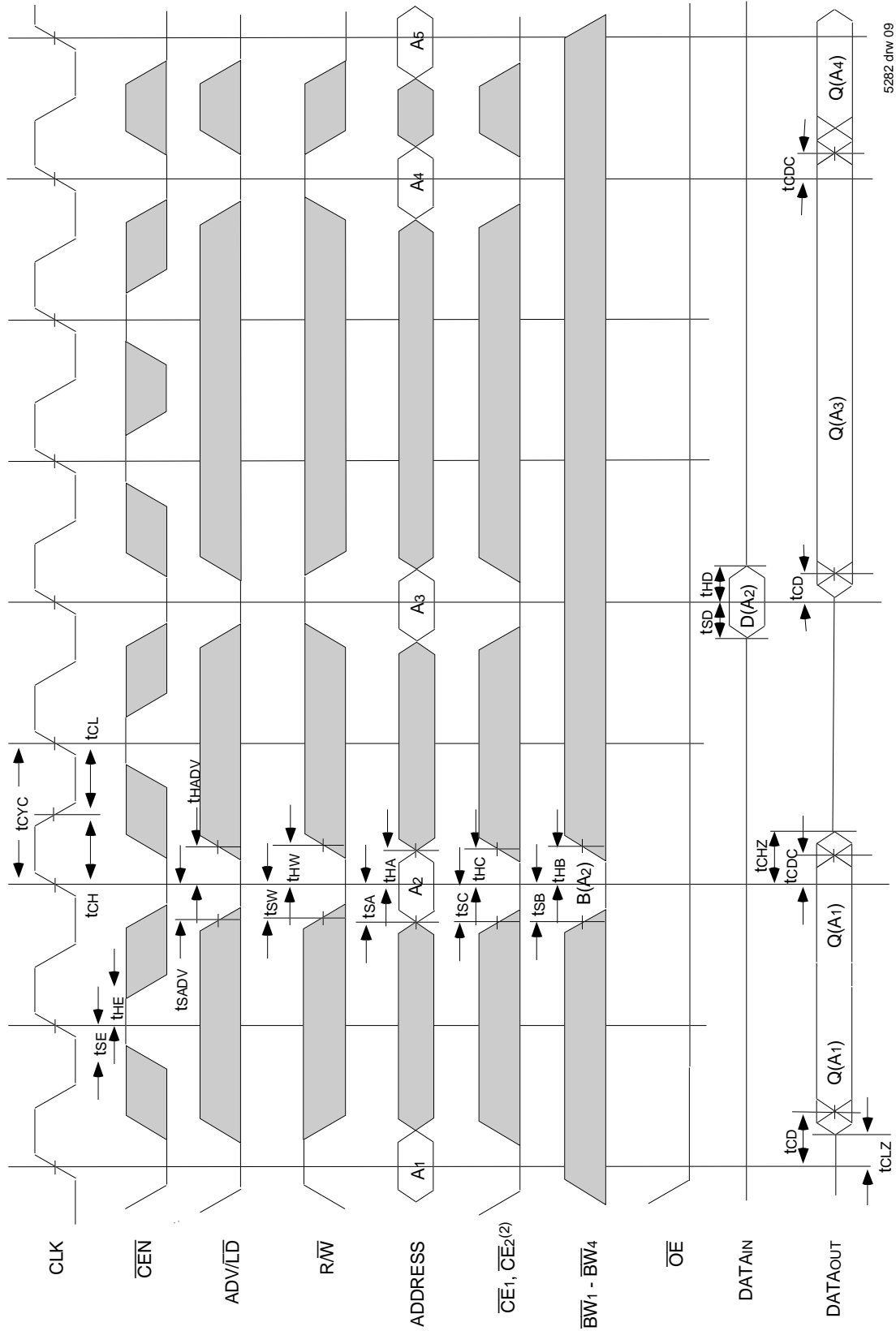

5282 drw 09

NOTES:

1. $\overline{\text{O}}$ ($A1$) represents the first output from the external address $A1$. D ($A2$) represents the input data to the SRAM corresponding to address $A2$.
2. $\overline{\text{CE2}}$ timing transitions are identical but inverted to the $\overline{\text{CE1}}$ and $\overline{\text{CE2}}$ signals. For example, when $\overline{\text{CE1}}$ and $\overline{\text{CE2}}$ are LOW on this waveform, $\overline{\text{CE2}}$ is HIGH.
3. $\overline{\text{CEN}}$ when sampled high on the rising edge of clock will block that L-H transition of the clock from propagating into the SRAM. The part will behave as if the L-H clock transition did not occur. All internal registers in the SRAM will retain their previous state.
4. Individual Byte/Write signals ($\overline{\text{BWx}}$) must be valid on all write and burst-write cycles. A write cycle is initiated when $\overline{\text{RW}}$ signal is sampled LOW. The byte write information comes in one cycle before the actual data is presented to the SRAM.

Timing Waveform of \overline{CS} Operation (1,2,3,4)

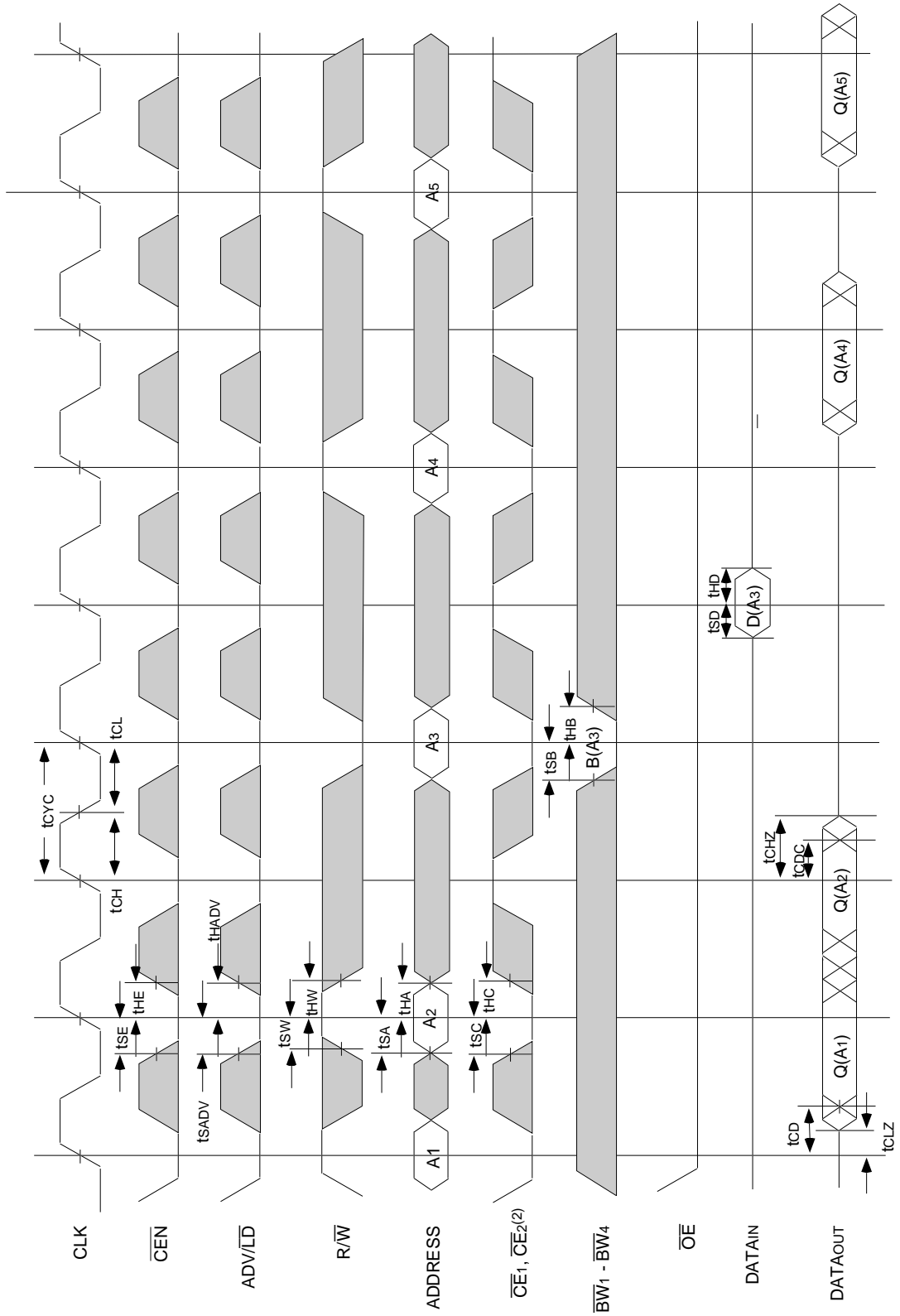

5282 dhw 10

NOTES:

1. Q (A₁) represents the first output from the external address A₁. D (A₃) represents the input data to the SRAM corresponding to address A₃ etc.
2. CE₂ timing transitions are identical but inverted to the \overline{CE}_1 and \overline{CE}_2 signals. For example, when \overline{CE}_1 and \overline{CE}_2 are LOW on this waveform, \overline{CE}_2 is HIGH.
3. When either one of the Chip enables ($\overline{CE}_1, \overline{CE}_2$) is sampled inactive at the rising clock edge, a deselect cycle is initiated. The data-bus tri-states one cycle after the initiation of the deselect cycle. This allows for any pending data transfers (reads or writes) to be completed.
4. Individual Byte Write signals (BW_x) must be valid on all write and burst-write cycles. A write cycle is initiated when \overline{RW} signals is sampled LOW. The byte write information comes in one cycle before the actual data is presented to the SRAM.

JTAG Interface Specification (SA Version only)

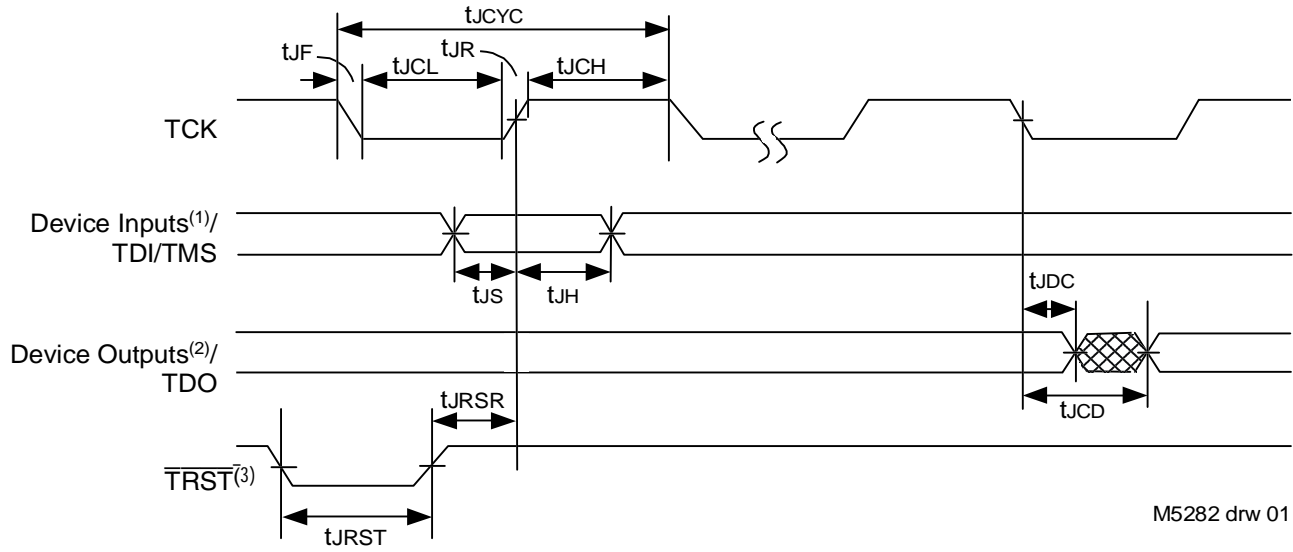

NOTES:

1. Device inputs = All device inputs except TDI, TMS and \overline{TRST} .
2. Device outputs = All device outputs except TDO.
3. During power up, \overline{TRST} could be driven low or not be used since the JTAG circuit resets automatically. \overline{TRST} is an optional JTAG reset.

JTAG AC Electrical Characteristics^(1,2,3,4)

| Symbol | Parameter | | | |
|------------|-------------------------|------|------------------|-------|
| | | Min. | Max. | Units |
| t_{JCYC} | JTAG Clock Input Period | 100 | — | ns |
| t_{JCH} | JTAG Clock HIGH | 40 | — | ns |
| t_{JCL} | JTAG Clock Low | 40 | — | ns |
| t_{JR} | JTAG Clock Rise Time | — | 5 ⁽¹⁾ | ns |
| t_{JF} | JTAG Clock Fall Time | — | 5 ⁽¹⁾ | ns |
| t_{JRST} | JTAG Reset | 50 | — | ns |
| t_{JRSR} | JTAG Reset Recovery | 50 | — | ns |
| t_{JCD} | JTAG Data Output | — | 20 | ns |
| t_{JDC} | JTAG Data Output Hold | 0 | — | ns |
| t_{JS} | JTAG Setup | 25 | — | ns |
| t_{JH} | JTAG Hold | 25 | — | ns |

I5282 tbl 01

NOTES:

1. Guaranteed by design.
2. AC Test Load (Fig. 1) on external output signals.
3. Refer to AC Test Conditions stated earlier in this document.
4. JTAG operations occur at one speed (10MHz). The base device may run at any speed specified in this datasheet.

Scan Register Sizes

| Register Name | Bit Size |
|----------------------------|----------|
| Instruction (IR) | 4 |
| Bypass (BYR) | 1 |
| JTAG Identification (JIDR) | 32 |
| Boundary Scan (BSR) | Note (1) |

I5282 tbl 03

NOTE:

1. The Boundary Scan Descriptive Language (BSDL) file for this device is available by contacting your local IDT sales representative.

JTAG Identification Register Definitions (SA Version only)

| Instruction Field | Value | Description |
|-----------------------------------|--------------|--|
| Revision Number (31:28) | 0x2 | Reserved for version number. |
| IDT Device ID (27:12) | 0x209, 0x20B | Defines IDT part number 71V3557SA and 71V3559SA, respectively. |
| IDT JEDEC ID (11:1) | 0x33 | Allows unique identification of device vendor as IDT. |
| ID Register Indicator Bit (Bit 0) | 1 | Indicates the presence of an ID register. |

I5282 tbl 02

Available JTAG Instructions

| Instruction | Description | OPCODE |
|----------------|---|--------|
| EXTEST | Forces contents of the boundary scan cells onto the device outputs ⁽¹⁾ . Places the boundary scan register (BSR) between TDI and TDO. | 0000 |
| SAMPLE/PRELOAD | Places the boundary scan register (BSR) between TDI and TDO. SAMPLE allows data from device inputs ⁽²⁾ and outputs ⁽¹⁾ to be captured in the boundary scan cells and shifted serially through TDO. PRELOAD allows data to be input serially into the boundary scan cells via the TDI. | 0001 |
| DEVICE_ID | Loads the JTAG ID register (JIDR) with the vendor ID code and places the register between TDI and TDO. | 0010 |
| HIGHZ | Places the bypass register (BYR) between TDI and TDO. Forces all device output drivers to a High-Z state. | 0011 |
| RESERVED | Several combinations are reserved. Do not use codes other than those identified for EXTEST, SAMPLE/PRELOAD, DEVICE_ID, HIGHZ, CLAMP, VALIDATE and BYPASS instructions. | 0100 |
| RESERVED | | 0101 |
| RESERVED | | 0110 |
| RESERVED | | 0111 |
| CLAMP | Uses BYR. Forces contents of the boundary scan cells onto the device outputs. Places the bypass register (BYR) between TDI and TDO. | 1000 |
| RESERVED | Same as above. | 1001 |
| RESERVED | | 1010 |
| RESERVED | | 1011 |
| RESERVED | | 1100 |
| VALIDATE | Automatically loaded into the instruction register whenever the TAP controller passes through the CAPTURE-IR state. The lower two bits '01' are mandated by the IEEE std. 1149.1 specification. | 1101 |
| RESERVED | Same as above. | 1110 |
| BYPASS | The BYPASS instruction is used to truncate the boundary scan register as a single bit in length. | 1111 |

I5282 tbl 04

NOTES:

1. Device outputs = All device outputs except TDO.
2. Device inputs = All device inputs except TDI, TMS, and $\overline{\text{TRST}}$.

100-Pin Thin Quad Plastic Flatpack (TQFP) Package Diagram Outline

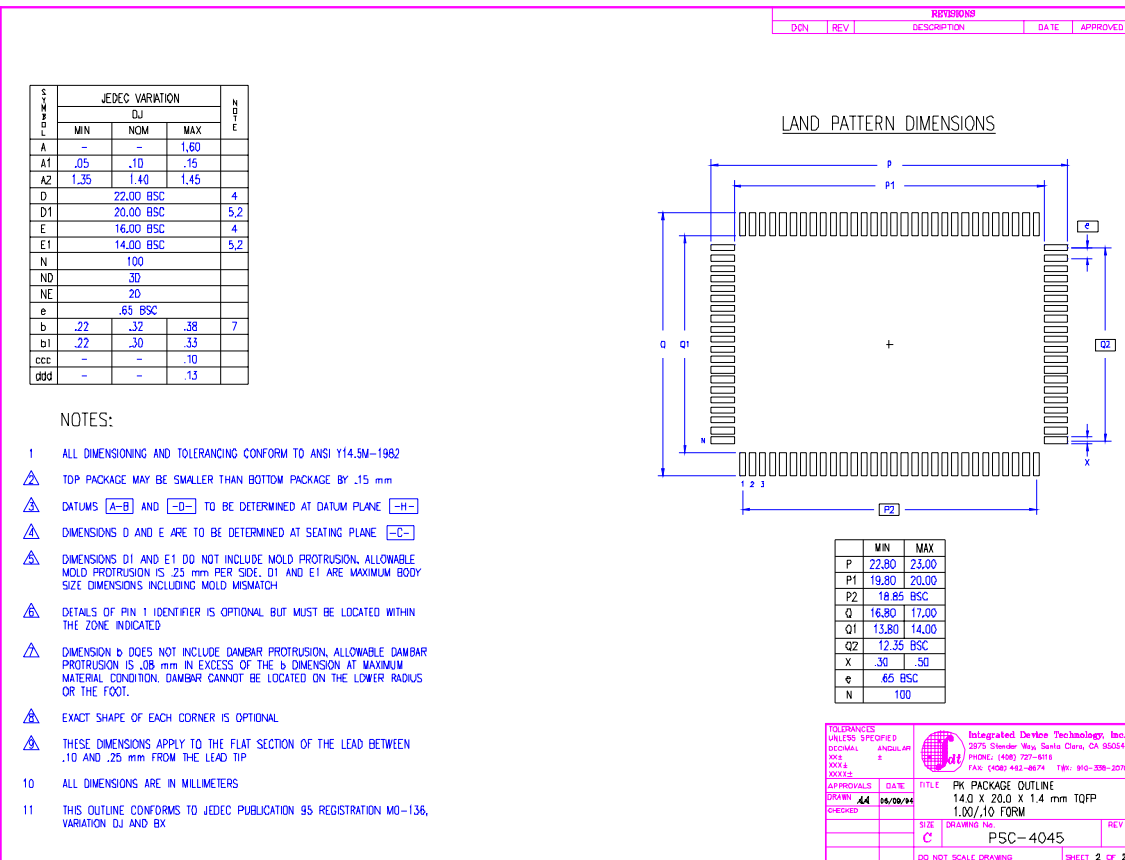
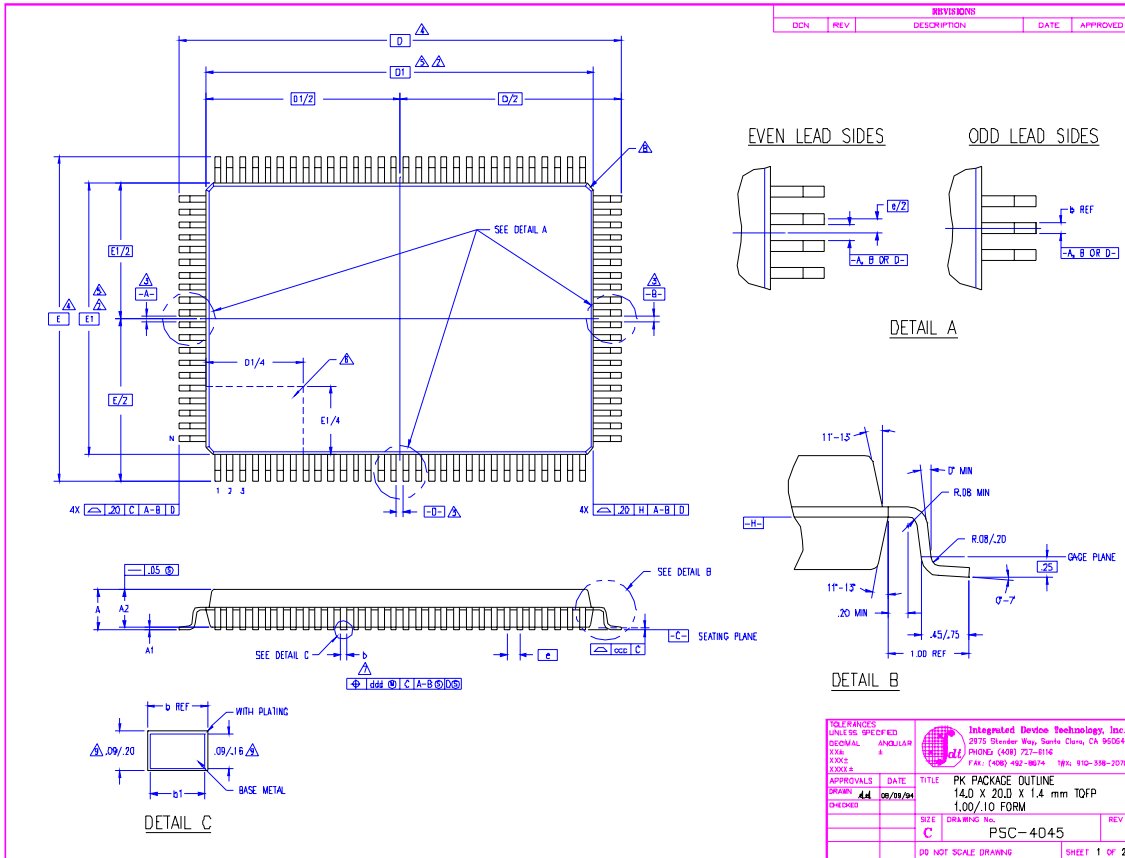

119 Ball Grid Array (BGA) Package Diagram Outline

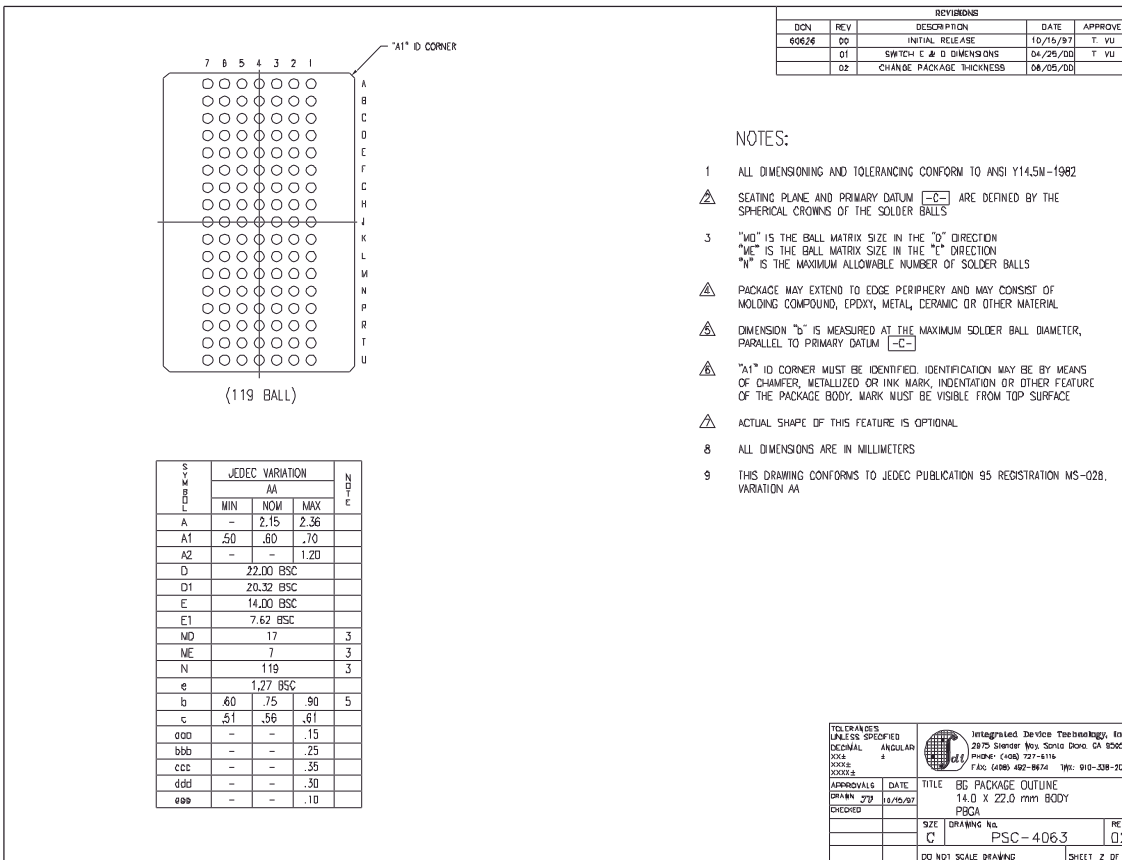
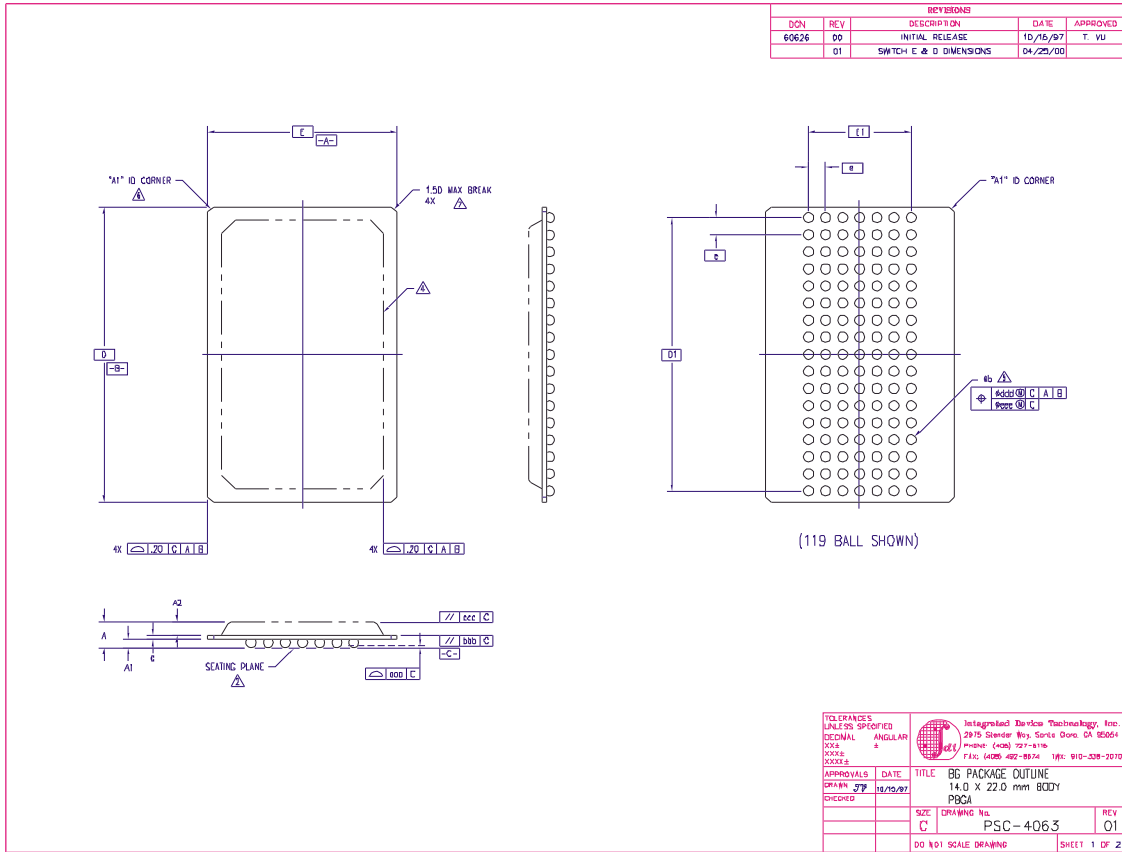

165 Fine Pitch Ball Grid Array (fBGA) Package Diagram Outline

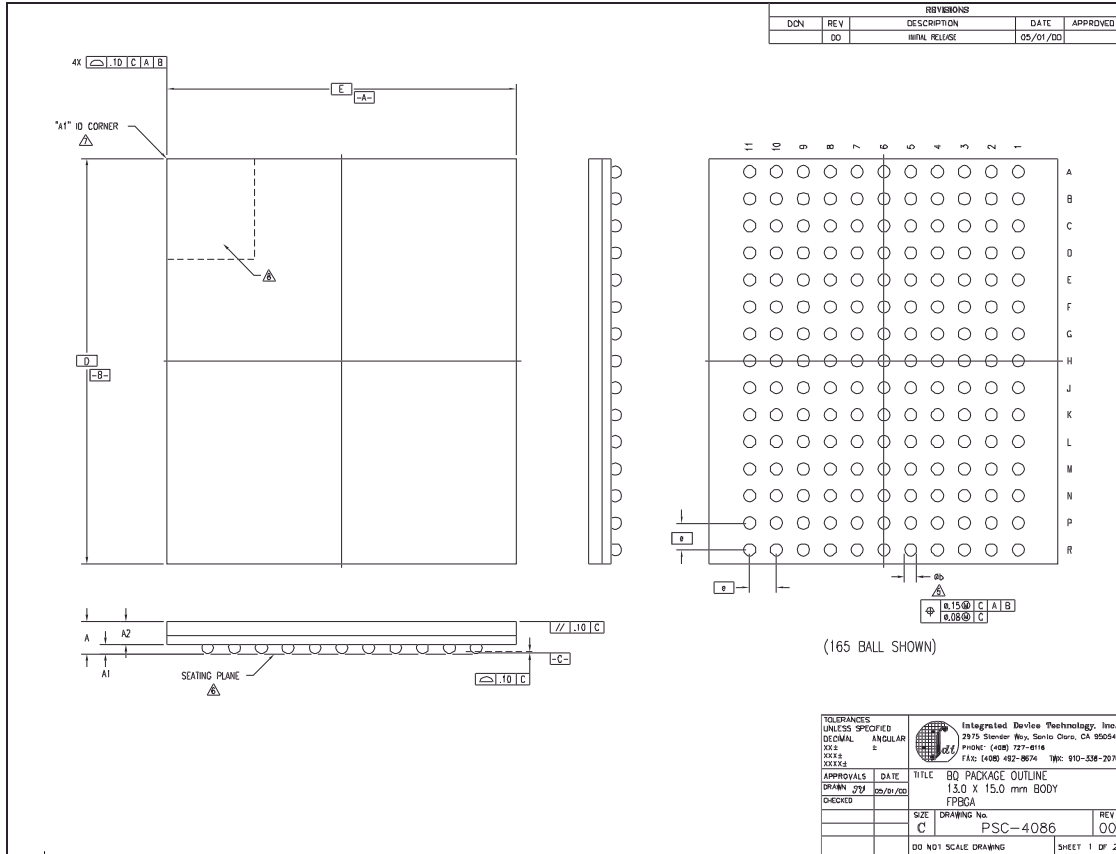

| | | |
|-----------------------------|-------------|---|
| TOLERANCES UNLESS SPECIFIED | | Integrated Device Technology, Inc. 2975 Stoner Way, Santa Clara, CA 95054 PHONE: (408) 727-8116 FAX: (408) 492-8674 TWP: 910-538-2070 |
| DECIMAL | ANGULAR | |
| XXX | XX.X | |
| APPROVALS | DATE | TITLE |
| DRAWN <i>gjt</i> | 05/29/00 | BQ PACKAGE OUTLINE |
| CHECKED | | 13.0 X 15.0 mm BODY |
| | | FPBGA |
| SIZE | DRAWING No. | REV |
| C | PSC-4086 | 00 |
| DO NOT SCALE DRAWING | | SHEET 1 OF 2 |

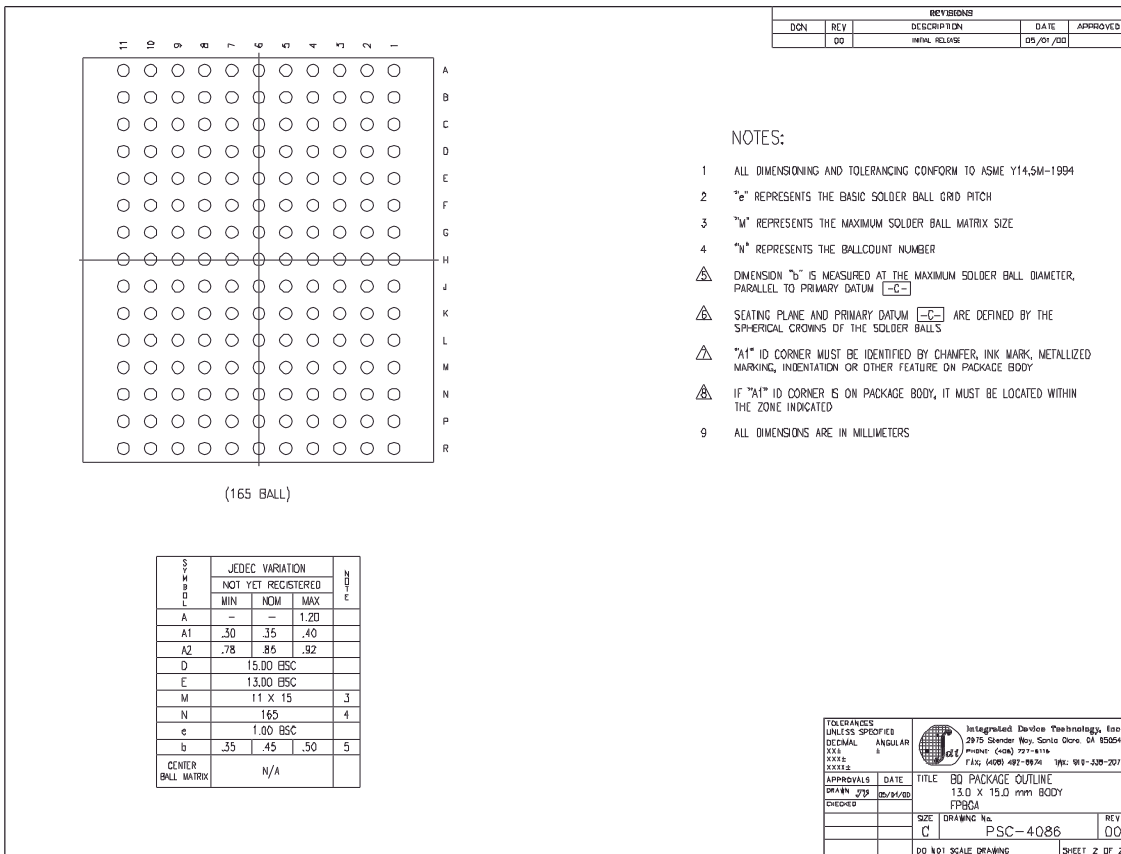

Timing Waveform of \overline{OE} Operation (1)

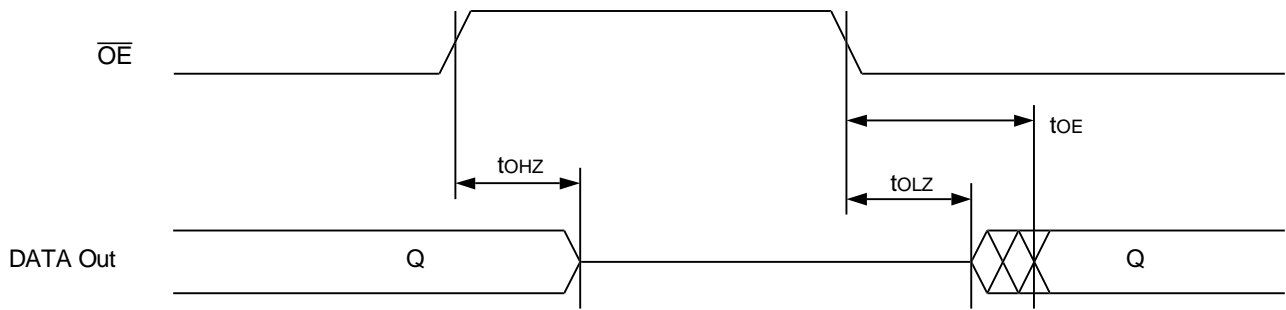

5282 drw 11

NOTE:

1. A read operation is assumed to be in progress.

Ordering Information

| XXXX | XX | XX | XX | X | X | |
|-------------|-------|-------|---------|---|----------------------------|--|
| Device Type | Power | Speed | Package | | Process/ Temperature Range | |
| | | | | | I | Blank Commercial (0°C to +70°C) Industrial (-40°C to +85°C) |
| | | | | | G | Restricted Hazardous Substance Device |
| | | | | | PF** BG BQ | 100-Pin Plastic Thin Quad Flatpack (TQFP) 119 Ball Grid Array (BGA) 165 Fine Pitch Ball Grid Array (fBGA) |
| | | | | | 75* 80 85 | Access time (tCD) in tenths of nanoseconds |
| | | | | | S SA | Standard Power Standard Power with JTAG Interface |
| | | | | | | IDT71V3557 128Kx36 Flow-Through ZBT SRAM with 3.3V I/O IDT71V3559 256Kx18 Flow-Through ZBT SRAM with 3.3V I/O |

5282 drw 12

*Commercial temperature range only.

** JTAG (SA version) is not available with 100-pin TQFP package

Datasheet Document History

| | | |
|----------|---------------------|---|
| 6/30/99 | | Updated to new format |
| 8/23/99 | Pg. 5, 6 | Added Pin 64 to Note 1 and changed Pins 38, 42, and 43 to DNU |
| | Pg. 7 | Changed U2–U6 to DNU |
| | Pg. 15 | Improved t _{CH} , t _{CL} ; revised t _{CLZ} |
| | Pg. 21 | Added BGA package diagrams |
| | Pg. 23 | Added Datasheet Document History |
| 12/31/99 | Pg. 5, 14, 15, 22 | Added Industrial Temperature range offerings |
| 05/02/00 | Pg. 5,6 | Insert clarification note to Recommended Operating Temperature and Absolute Max ratings tables |
| | Pg. 5,6,7 | Clarify note on TQFP and BGA pin configurations; corrected typo in pinout |
| | Pg. 6 | Add BGA capacitance table |
| | Pg. 21 | Add TQFP Package Diagram Outline |
| 05/26/00 | | Add new package offering 13 x 15mm 165 fBGA |
| | Pg. 23 | Correct 119 BGA Package Diagram Outline |
| 07/26/00 | Pg. 5-8 | Add ZZ sleep mode reference note to TQFP, BG119 and BQ165 |
| | Pg. 8 | Update BQ165 pinout |
| | Pg. 23 | Update BG119 pinout package diagram dimensions |
| 10/25/00 | | Remove preliminary status |
| | Pg. 8 | Add reference note to pin N5 on BQ165 pinout, reserved for JTAG $\overline{\text{TRST}}$ |
| 05/20/02 | Pg. 1-8,15,22,23,27 | Added JTAG "SA" version functionality and updated ZZ pin descriptions and notes. |
| 10/15/04 | Pg. 7 | Updated pin configuration for the 119 BGA - reordered I/O signals on P6, P7 (128K x 36) and P7, N6, L6, K7, H6, G7, F6, E7, D6 (256K x 18). |
| 12/07/05 | Pg. 27 | Added "Restricted hazardous substance device" to ordering information. |



CORPORATE HEADQUARTERS
6024 Silver Creek Valley Rd
San Jose, CA 95138

for SALES:
800-345-7015 or 408-284-8200
fax: 408-284-2775
www.idt.com

for Tech Support:
sramhelp@idt.com
800-345-7015 or
408/284-4555

X-ON Electronics

Largest Supplier of Electrical and Electronic Components

Click to view similar products for [SRAM](#) category:

Click to view products by [IDT](#) manufacturer:

Other Similar products are found below :

[5962-8855206XA](#) [CY6116A-35DMB](#) [CY7C128A-45DMB](#) [CY7C1461KV33-133AXI](#) [CY7C199-45LMB](#) [CYDM128B16-55BVXIT](#)
[GS8161Z36DD-200I](#) [GS88237CB-200I](#) [R1QDA7236ABB-20IB0](#) [RMLV0408EGSB-4S2#AA0](#) [IS64WV3216BLL-15CTLA3](#)
[IS66WVE4M16ECLL-70BLI](#) [PCF8570P](#) [K6T4008C1B-GB70](#) [CY7C1353S-100AXC](#) [AS6C8016-55BIN](#) [515712X](#) [IS62WV51216EBLL-](#)
[45BLI](#) [IS63WV1288DBLL-10HLI](#) [IS66WVE2M16ECLL-70BLI](#) [47L16-E/SN](#) [IS66WVE4M16EALL-70BLI](#) [IS62WV6416DBLL-45BLI](#)
[IS61WV102416DBLL-10TLI](#) [CY7C1381KV33-100AXC](#) [CY7C1381KV33-100BZXI](#) [CY7C1373KV33-100AXC](#) [CY7C1381KVE33-133AXI](#)
[CY7C4042KV13-933FCXC](#) [8602501XA](#) [5962-3829425MUA](#) [5962-8855206YA](#) [5962-8866201XA](#) [5962-8866201YA](#) [5962-8866204TA](#)
[5962-8866206MA](#) [5962-8866207NA](#) [5962-8866208UA](#) [5962-8872502XA](#) [5962-8959836MZA](#) [5962-8959841MZA](#) [5962-9062007MXA](#)
[5962-9161705MXA](#) [N08L63W2AB7I](#) [7130LA100PDG](#) [GS81284Z36B-250I](#) [M38510/28902BVA](#) [IS62WV12816ALL-70BLI](#) [5962-](#)
[8971203XA](#) [5962-8971202ZA](#)