

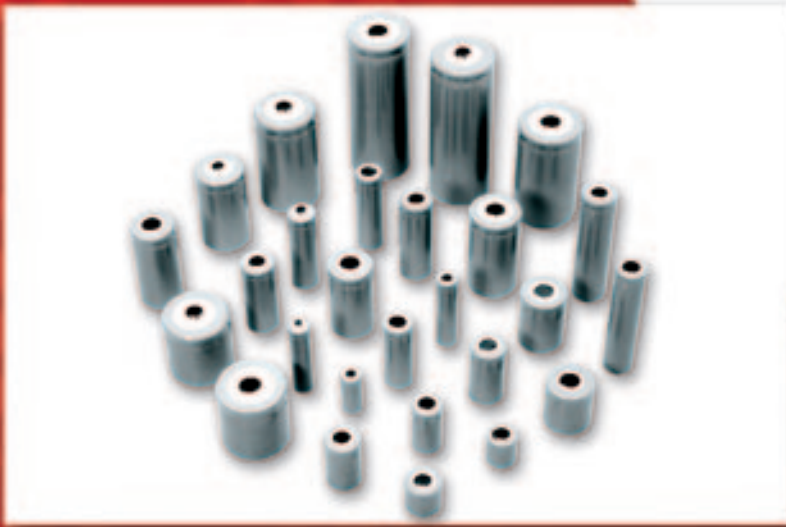

NiCd



Cylindrical Nickel Cadmium (NiCd)

NiCd

Cylindrical Nickel Cadmium (NiCd)

FEATURES

- **High Capacity** - Using latest technology, Yuasa Nicad product has some of the highest capacities available.
- **Long Service Life** - Depending upon application up to 1000 charge / discharge cycles can be expected.
- **High Temperature Options** - Some popular cell sizes are available in high temperature versions.

Product Details

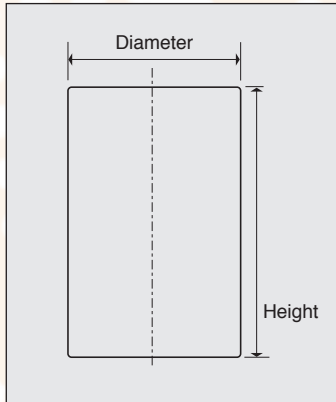

Can Size	Diameter (mm)	Height (mm)
AA	14.1	48.0
7 / 5 AA	14.1	64.4
4 / 5 AA	14.1	42.6
2 / 3AA	14.1	28.0
1 / 2 AA	14.1	24.0
1 / 3 AA	14.1	16.5
AAA	10.1	43.6
2 / 3 AAA	10.1	27.8
1 / 2 AAA	10.1	25.0
1 / 4 AAA	10.1	12.0
AAAA	8.1	41.5
F	32.3	89.0
D	32.3	59.0
1 / 2 D	32.3	35.0

Can Size	Diameter (mm)	Height (mm)
A / AF	16.8	49.0
7 / 5 A / AF	16.8	65.9
4 / 5 A	16.8	42.1
2 / 3 A	16.8	32.9
1 / 2 A	16.8	28.0
1 / 3 A	16.5	16.5
C	25.3	49.0
1 / 2 C	25.3	23.0
1 / 3 C	25.3	19.1
SC	22.2	42.0
5 / 4 SC	22.2	49.0
4 / 5 SC	22.2	32.5
1 / 2 SC	22.2	25.5
N	11.7	28.5

Available Capacities

Can Size	Capacities Available (mAh)
AA	600, 700, 800, 900, 1000
7 / 5 AA	1200
4 / 5 AA	600
2 / 3AA	400
1 / 2 AA	300
1 / 3 AA	170
AAA	320
2 / 3 AAA	170
1 / 2 AAA	100
F	8000
D	4000, 4400, 5000
1 / 2 D	2500

Note: Other capacities may be available on request.

Can Size	Capacities Available (mAh)
A	1200, 1300, 1400
7 / 5 A	1800
4 / 5 A	1200
2 / 3 A	750
1 / 2 A	600, 650
1 / 3 A	250
C	2200, 2500, 2800, 3000
1 / 2 C	750
SC	1600, 1800, 2000
5 / 4 SC	2300
4 / 5 SC	1000, 1200
1 / 2 SC	750, 800
N	220

High Temp Cells

Can Size	Capacities Available (mAh)
D	4000, 4400
C	2500
Sub C	1600, 1800

Yuasa High Temperature Cells comply with BS EN 60285.

Packs

All Yuasa cylindrical cells can be connected together to form higher voltage packs. Depending upon quantities required almost any configuration can be achieved. Details available upon request.

Example Configurations

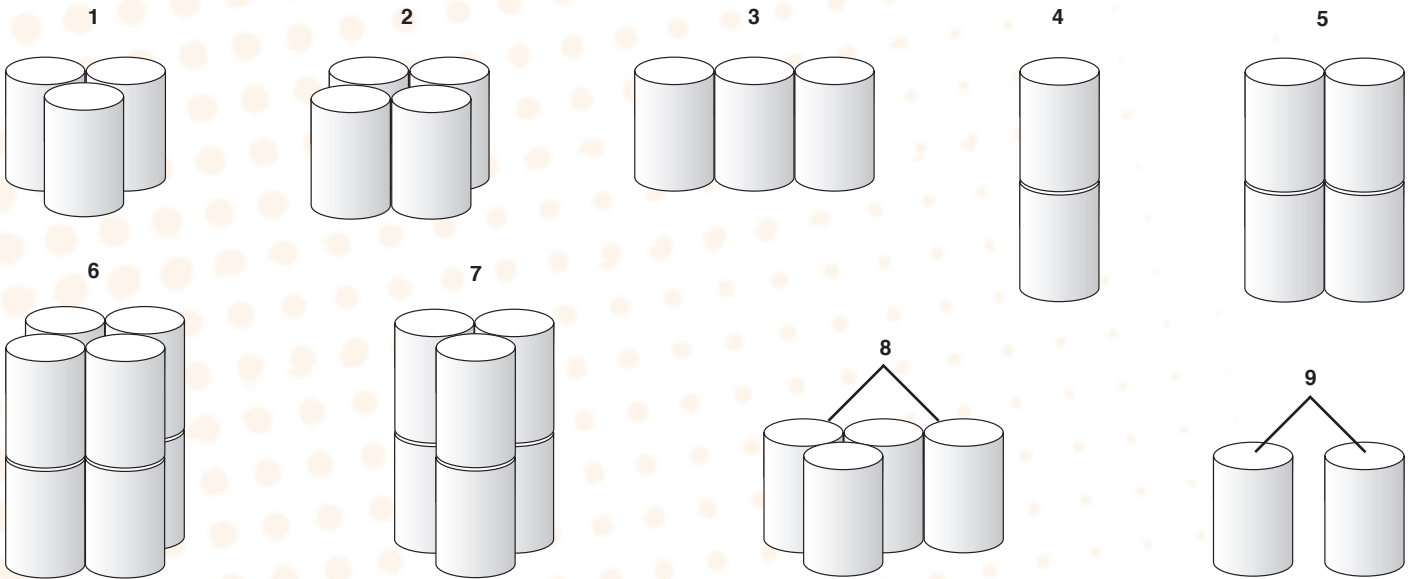

Style No	Styles Configuration Description
1	Cells upright and diagonal to each other for smallest possible pack size
2	Cells upright and next to each other in parallel rows
3	Cells upright in single row
4	Cells upright with one directly on top of another. Commonly called a 'stick'
5	Cells upright in twin 'stick'
6	Cells upright with 4 sticks connected in parallel rows
7	Cells upright with sticks connected diagonally for smallest pack size
8	Customer specified configuration
9	Customer specified configuration requiring special manufacturing requirements

Part numbers for packs incorporate all the information required to identify manufacturing details. **E.g. 6DH4-OL3** - This code translates as **6** x '**D**' cells **H**igh temp **4Ah** with **L**eads and configured using style **3**.

Disposal of "Spent" NiCd batteries:

Please check the latest recommendations by contacting the technical helpdesk.

Tel: 08708 500314

Fax: 08708 500317

Email: enquiries@yuasa-sales.co.uk

General Characteristic Graphs

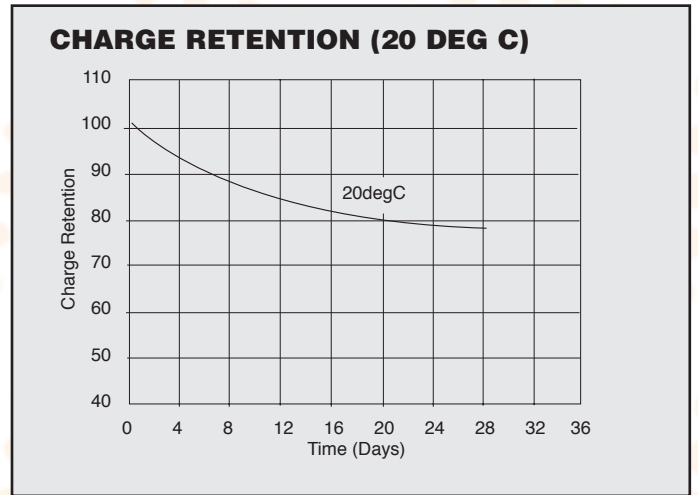
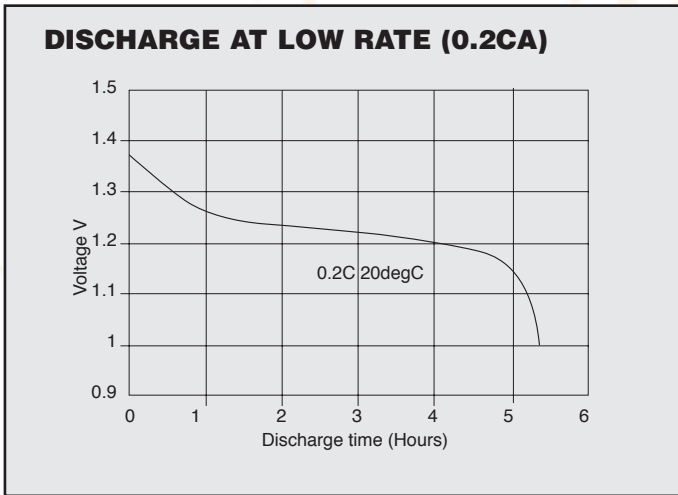
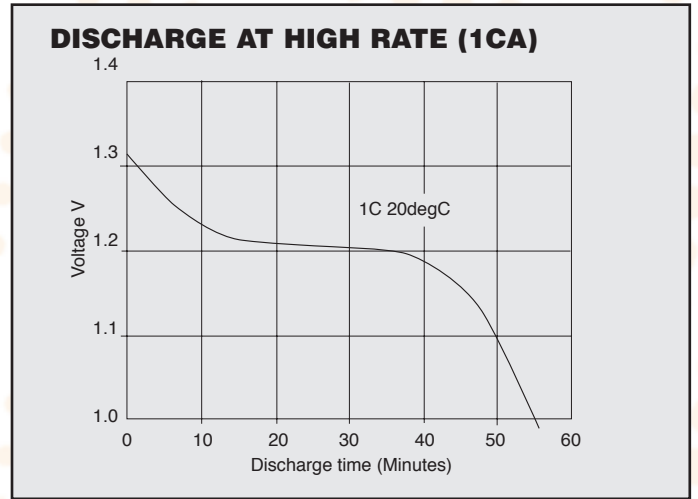
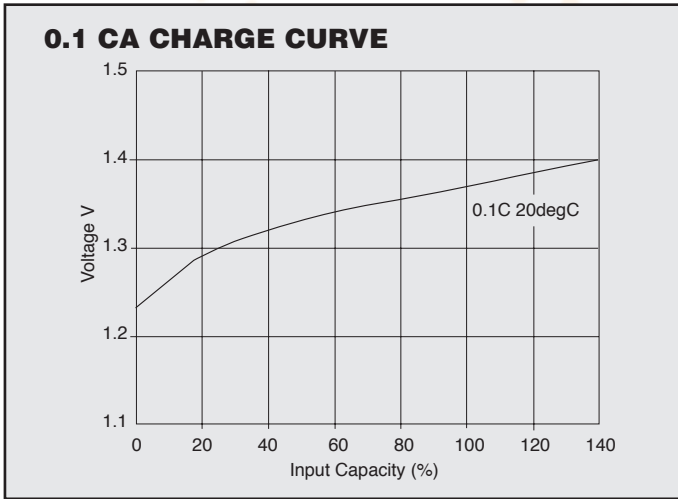

Charging

Trickle	0.05 CA	48 Hours - Constant
Standard	0.1 CA	14-16 Hours
Quick	0.3 CA	4 Hours

- Maximum Cell voltage should be considered to be 1.7 Volts.
- $-\Delta V$ termination should be set at 20-30 mV/cell.
- DT/dt termination should be 0.5°C/Minute.



Yuasa Battery Sales (UK) Ltd

Unit 22 Rassau Industrial Estate
 Ebbw Vale, Gwent, NP23 5SD
 Tel: 08708 500312 Fax: 08708 500317
 E-mail: enquiries@yuasa-sales.co.uk

Registered number 1548820

Cat. No. NiCdSF April 06

E&O.E.

Distributed by

X-ON Electronics

Largest Supplier of Electrical and Electronic Components

Click to view similar products for [yuasa manufacturer:](#)

Other Similar products are found below :

[3DH4-0LAP3](#) [Y4-6](#) [DM55-12FR](#) [NPX-80BFR](#) [Y12-6L](#) [NPC24-12](#) [NP38-12BFR](#) [NPX-25TGNV](#) [Y10-6](#) [NP18-12BFR](#) [Y4-12](#) [NP12-12TFR](#)
[NP10-6FR](#) [Y1.2-6](#) [Y2.8-12](#) [Y12-12](#) [4DH4-0LA4](#) [5DH4-0T4](#) [Y17-12](#) [NP12-6](#) [NP4.0-12](#) [Y2.1-12](#) [NP1-6](#) [1DH4-0T](#) [NP2.6-12](#) [NP2.8-6](#)
[NP2.6-12FR](#) [Y1.2-12](#) [NP2.1-12](#) [Y7-12](#) [NP3.2-12](#) [NP12-12](#)