

SPECIFICATIONS FOR NICHIA WHITE LED

MODEL : NSPW310DS

NICHIA CORPORATION

1. SPECIFICATIONS

(1) Absolute Maximum Ratings (Ta=25°C)

Item	Symbol	Absolute Maximum Rating	Unit
Forward Current	IF	30	mA
Pulse Forward Current	IFP	100	mA
Reverse Voltage	VR	5	V
Power Dissipation	PD	105	mW
Operating Temperature	Topr	-30 ~ + 85	°C
Storage Temperature	Tstg	-40 ~ +100	°C
Soldering Temperature	Tsld	265°C for 10sec.	

IFP Conditions : Pulse Width ≤ 10msec. and Duty ≤ 1/10

(2) Initial Electrical/Optical Characteristics (Ta=25°C)

Item	Symbol	Condition	Typ.	Max.	Unit	
Forward Voltage	VF	IF=20[mA]	(3.2)	3.5	V	
Reverse Current	IR	VR= 5[V]	-	50	μA	
Luminous Intensity	Iv	IF=20[mA]	(6.20)(new)*1	-	cd	
Luminous Intensity	Iv	IF=20[mA]	(6.80)(old)*2	-	cd	
Chromaticity Coordinate*	x	-	IF=20[mA]	0.31	-	-
	y	-	IF=20[mA]	0.32	-	-

* Please refer to CIE 1931 chromaticity diagram.

*1 Change previously listed luminous intensity values (see *2) to luminous intensity values traceable to the current national standards on and after January 1, 2009.

(In accordance with CIE 127:2007)

(3) Ranking (Ta=25°C)

Item	Symbol	Condition	Min.	Max.	Unit	
Luminous Intensity (new)*1	Rank W	Iv	IF=20[mA]	6.51	9.22	cd
	Rank V	Iv	IF=20[mA]	4.61	6.51	cd
	Rank U	Iv	IF=20[mA]	3.25	4.61	cd

(Ta=25°C)

Item	Symbol	Condition	Min.	Max.	Unit	
Luminous Intensity (old)*2	Rank W	Iv	IF=20[mA]	7.15	10.10	cd
	Rank V	Iv	IF=20[mA]	5.05	7.15	cd
	Rank U	Iv	IF=20[mA]	3.56	5.05	cd

* Luminous Intensity Measurement allowance is ± 10%.

Color Ranks

(IF=20mA, Ta=25°C)

Rank a0				
x	0.280	0.264	0.283	0.296
y	0.248	0.267	0.305	0.276

Rank b1				
x	0.287	0.283	0.330	0.330
y	0.295	0.305	0.360	0.339

6.RELIABILITY

(1) TEST ITEMS AND RESULTS

Test Item	Standard Test Method	Test Conditions	Note	Number of Damaged
Resistance to Soldering Heat	JEITA ED-4701 300 302	Tsld=260 ± 5°C, 10sec. 3mm from the base of the epoxy bulb	1 time	0/50
Solderability	JEITA ED-4701 300 303	Tsld=235 ± 5°C, 5sec. (using flux)	1 time over 95%	0/50
Temperature Cycle	JEITA ED-4701 100 105	-40°C ~ 25°C ~ 100°C ~ 25°C 30min. 5min. 30min. 5min.	100 cycles	0/50
Moisture Resistance Cyclic	JEITA ED-4701 200 203	25°C ~ 65°C ~ -10°C 90%RH 24hrs./1cycle	10 cycles	0/50
Terminal Strength (bending test)	JEITA ED-4701 400 401	Load 5N (0.5kgf) 0° ~ 90° ~ 0° bend 2 times	Nonnoticeable damage	0/50
Terminal Strength (pull test)	JEITA ED-4701 400 401	Load 10N (1kgf) 10 ± 1 sec.	Nonnoticeable damage	0/50
High Temperature Storage	JEITA ED-4701 200 201	Ta=100°C	1000hrs.	0/50
Temperature Humidity Storage	JEITA ED-4701 100 103	Ta=60°C, RH=90%	1000hrs.	0/50
Low Temperature Storage	JEITA ED-4701 200 202	Ta=-40°C	1000hrs.	0/50
Steady State Operating Life		Ta=25°C, IF=30mA	1000hrs.	0/50
Steady State Operating Life of High Humidity Heat		60°C, RH=90%, IF=20mA	500hrs.	0/50
Steady State Operating Life of Low Temperature		Ta=-30°C, IF=20mA	1000hrs.	0/50

(2) CRITERIA FOR JUDGING DAMAGE

Item	Symbol	Test Conditions	Criteria for Judgement	
			Min.	Max.
Forward Voltage	V _F	I _F =20mA	-	U.S.L.*) × 1.1
Reverse Current	I _R	V _R =5V	-	U.S.L.*) × 2.0
Luminous Intensity	I _V	I _F =20mA	L.S.L.***) × 0.7	-

*) U.S.L. : Upper Standard Level

**) L.S.L. : Lower Standard Level

7. CAUTIONS

The LEDs are devices which are materialized by combining Blue LEDs and special phosphors. Consequently, the color of the LEDs is changed a little by an operating current. Care should be taken after due consideration when using LEDs.

(1) Lead Forming

- When forming leads, the leads should be bent at a point at least 3mm from the base of the epoxy bulb. Do not use the base of the leadframe as a fulcrum during lead forming.
- Lead forming should be done before soldering.
- Do not apply any bending stress to the base of the lead. The stress to the base may damage the LED's characteristics or it may break the LEDs.
- When mounting the LEDs onto a printed circuit board, the holes on the circuit board should be exactly aligned with the leads of the LEDs. If the LEDs are mounted with stress at the leads, it causes deterioration of the epoxy resin and this will degrade the LEDs.

(2) Storage

- The LEDs should be stored at 30°C or less and 70%RH or less after being shipped from Nichia and the storage life limits are 3 months. If the LEDs are stored for 3 months or more, they can be stored for a year in a sealed container with a nitrogen atmosphere and moisture absorbent material.
- Nichia LED leadframes are silver plated copper alloy. The silver surface may be affected by environments which contain corrosive substances. Please avoid conditions which may cause the LED to corrode, tarnish or discolor. This corrosion or discoloration may cause difficulty during soldering operations. It is recommended that the LEDs be used as soon as possible.
- Please avoid rapid transitions in ambient temperature, especially, in high humidity environments where condensation can occur.

(3) Recommended circuit

- In designing a circuit, the current through each LED must not exceed the absolute maximum rating specified for each LED. It is recommended to use Circuit B which regulates the current flowing through each LED. In the meanwhile, when driving LEDs with a constant voltage in Circuit A, the current through the LEDs may vary due to the variation in forward voltage (V_F) of the LEDs. In the worst case, some LED may be subjected to stresses in excess of the absolute maximum rating.

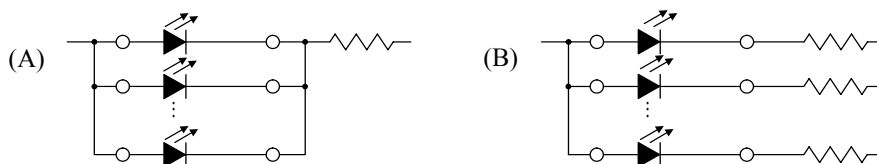

- This product should be operated in forward bias. A driving circuit must be designed so that the product is not subjected to either forward or reverse voltage while it is off. In particular, if a reverse voltage is continuously applied to the product, such operation can cause migration resulting in LED damage.

(4) Static Electricity

- Static electricity or surge voltage damages the LEDs.
 It is recommended that a wrist band or an anti-electrostatic glove be used when handling the LEDs.
- All devices, equipment and machinery must be properly grounded. It is recommended that precautions be taken against surge voltage to the equipment that mounts the LEDs.
- When inspecting the final products in which LEDs were assembled, it is recommended to check whether the assembled LEDs are damaged by static electricity or not. It is easy to find static-damaged LEDs by a light-on test or a VF test at a lower current (below 1mA is recommended).
- Damaged LEDs will show some unusual characteristics such as the leak current remarkably increases, the forward voltage becomes lower, or the LEDs do not light at the low current.

Criteria : (VF > 2.0V at IF=0.5mA)

(5) Soldering Conditions

- Nichia LED leadframes are silver plated copper alloy. This substance has a low thermal coefficient (easily conducts heat). Careful attention should be paid during soldering.
- Solder the LED no closer than 3mm from the base of the epoxy bulb. Soldering beyond the base of the tie bar is recommended.
- Recommended soldering conditions

Dip Soldering		Hand Soldering	
Pre-Heat	120°C Max.	Temperature	350°C Max.
Pre-Heat Time	60 seconds Max.	Soldering Time	3 seconds Max.
Solder Bath Temperature	260°C Max.	Position	No closer than 3 mm from the base of the epoxy bulb.
Dipping Time	10 seconds Max.		
Dipping Position	No lower than 3 mm from the base of the epoxy bulb.		

- Although the recommended soldering conditions are specified in the above table, dip or hand soldering at the lowest possible temperature is desirable for the LEDs.
- A rapid-rate process is not recommended for cooling the LEDs down from the peak temperature.
- Dip soldering should not be done more than one time.
- Hand soldering should not be done more than one time.
- Do not apply any stress to the lead particularly when heated.
- The LEDs must not be repositioned after soldering.
- After soldering the LEDs, the epoxy bulb should be protected from mechanical shock or vibration until the LEDs return to room temperature.
- Direct soldering onto a PC board should be avoided. Mechanical stress to the resin may be caused from warping of the PC board or from the clinching and cutting of the leadframes. When it is absolutely necessary, the LEDs may be mounted in this fashion but the User will assume responsibility for any problems. Direct soldering should only be done after testing has confirmed that no damage, such as wire bond failure or resin deterioration, will occur. Nichia's LEDs should not be soldered directly to double sided PC boards because the heat will deteriorate the epoxy resin.
- When it is necessary to clamp the LEDs to prevent soldering failure, it is important to minimize the mechanical stress on the LEDs.
- Cut the LED leadframes at room temperature. Cutting the leadframes at high temperatures may cause failure of the LEDs.

(6) Heat Generation

- Thermal design of the end product is of paramount importance. Please consider the heat generation of the LED when making the system design. The coefficient of temperature increase per input electric power is affected by the thermal resistance of the circuit board and density of LED placement on the board, as well as other components. It is necessary to avoid intense heat generation and operate within the maximum ratings given in this specification.
- The operating current should be decided after considering the ambient maximum temperature of LEDs.

(7) Cleaning

- It is recommended that isopropyl alcohol be used as a solvent for cleaning the LEDs. When using other solvents, it should be confirmed beforehand whether the solvents will dissolve the resin or not. Freon solvents should not be used to clean the LEDs because of worldwide regulations.
- Do not clean the LEDs by the ultrasonic. When it is absolutely necessary, the influence of ultrasonic cleaning on the LEDs depends on factors such as ultrasonic power and the assembled condition. Before cleaning, a pre-test should be done to confirm whether any damage to the LEDs will occur.

(8) Safety Guideline for Human Eyes

- The International Electrical Commission (IEC) published in 2006 IEC 62471:2006 *Photobiological safety of lamps and lamp systems* which includes LEDs within its scope. Meanwhile LEDs were removed from the scope of the IEC 60825-1:2007 laser safety standard, the 2001 edition of which included LED sources within its scope. However, keep in mind that some countries and regions have adopted standards based on the IEC laser safety standard IEC 60825-1:2001 which includes LEDs within its scope.

Following IEC 62471:2006, most of Nichia LEDs can be classified as belonging to either Exempt Group or Risk Group 1. Optical characteristics of a LED such as output power, spectrum and light distribution are factors that affect the risk group determination of the LED. Especially a high-power LED, that emits light containing blue wavelengths, may be in Risk Group 2.

Great care should be taken when viewing directly the LED driven at high current or the LED with optical instruments, which may greatly increase the hazard to your eyes.

(9) Others

- NSPW310DS complies with RoHS Directive.
- Care must be taken to ensure that the reverse voltage will not exceed the absolute maximum rating when using the LEDs with matrix drive.
- Flashing lights have been known to cause discomfort in people; you can prevent this by taking precautions during use. Also, people should be cautious when using equipment that has had LEDs incorporated into it.
- The LEDs described in this brochure are intended to be used for ordinary electronic equipment (such as office equipment, communications equipment, measurement instruments and household appliances). Consult Nichia's sales staff in advance for information on the applications in which exceptional quality and reliability are required, particularly when the failure or malfunction of the LEDs may directly jeopardize life or health (such as for airplanes, aerospace, submersible repeaters, nuclear reactor control systems, automobiles, traffic control equipment, life support systems and safety devices).
- User shall not reverse engineer by disassembling or analysis of the LEDs without having prior written consent from Nichia. When defective LEDs are found, the User shall inform Nichia directly before disassembling or analysis.
- The formal specifications must be exchanged and signed by both parties before large volume purchase begins.
- The appearance and specifications of the product may be modified for improvement without notice.

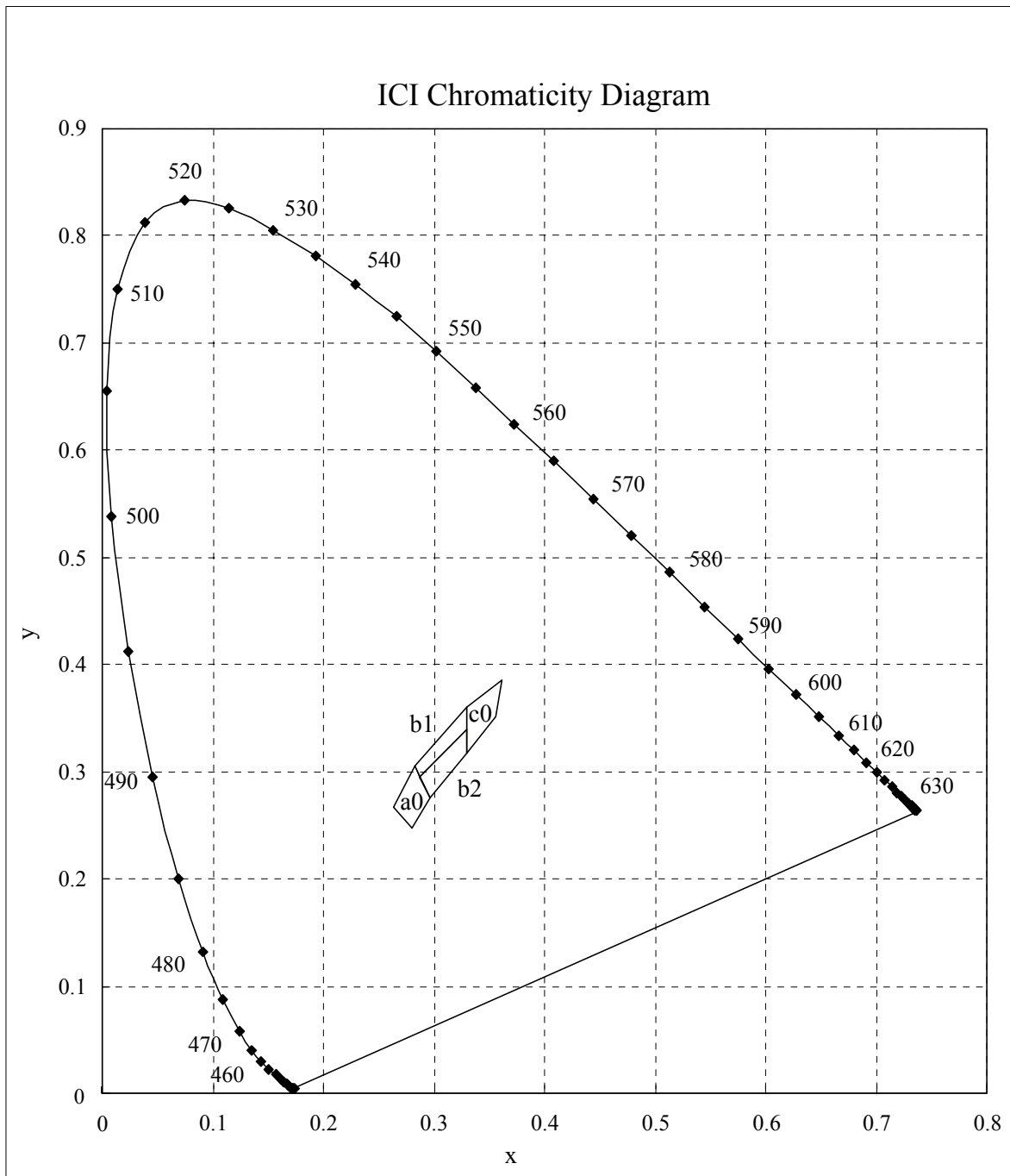

* Color Coordinates Measurement allowance is ± 0.01 .

■ Forward Voltage vs. Forward Current

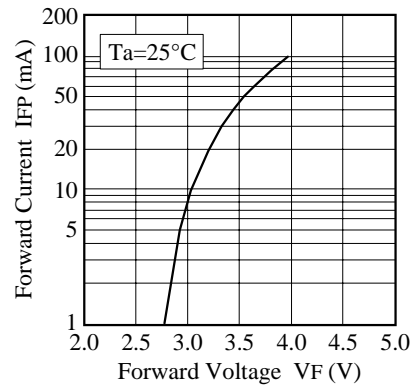

■ Forward Current vs. Relative Luminosity

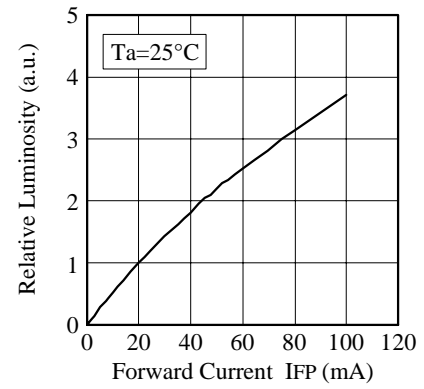

■ Duty Ratio vs. Allowable Forward Current IFP

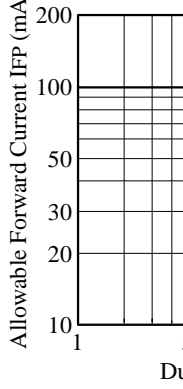

■ Ambient Temperature vs. Forward Voltage

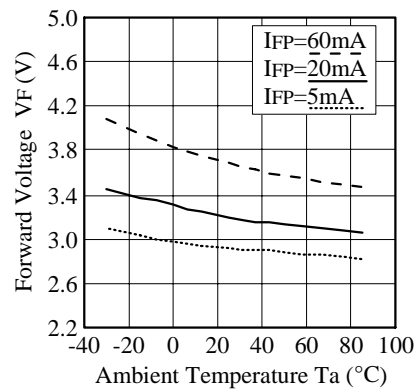

■ Ambient Temperature vs. Relative Luminosity

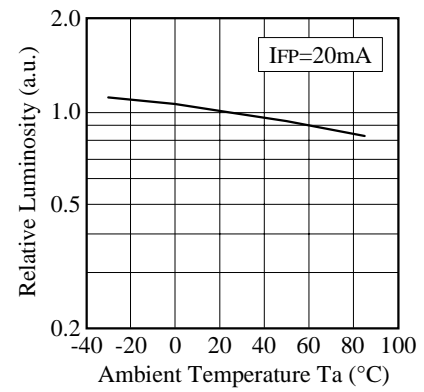

■ Ambient Temperature vs. Allowable Forward Current IFP

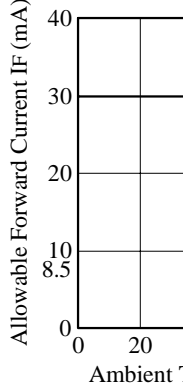

■ Forward Current vs. Chromaticity Coordinate

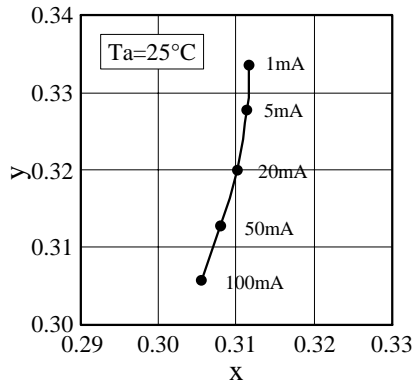

■ Ambient Temperature vs. Chromaticity Coordinate

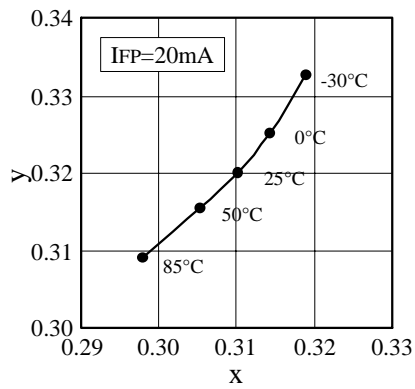

■ Spectrum

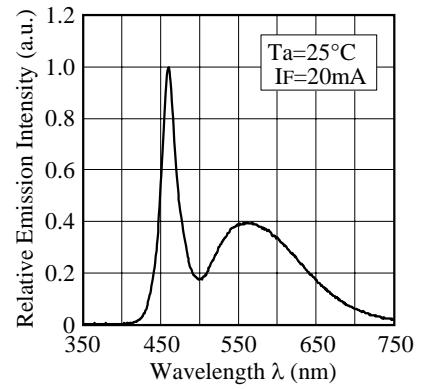

■ Directivity

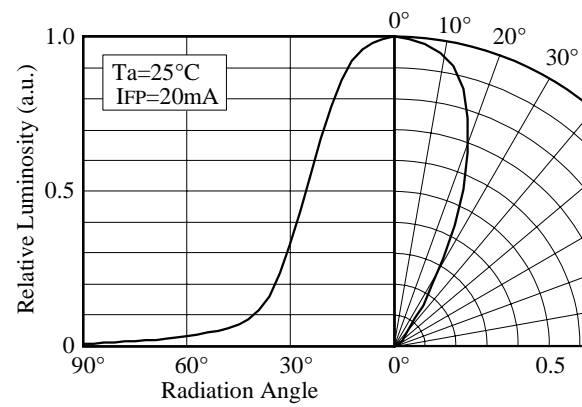

NICHIA CORPORATION

Mo
Tit
No

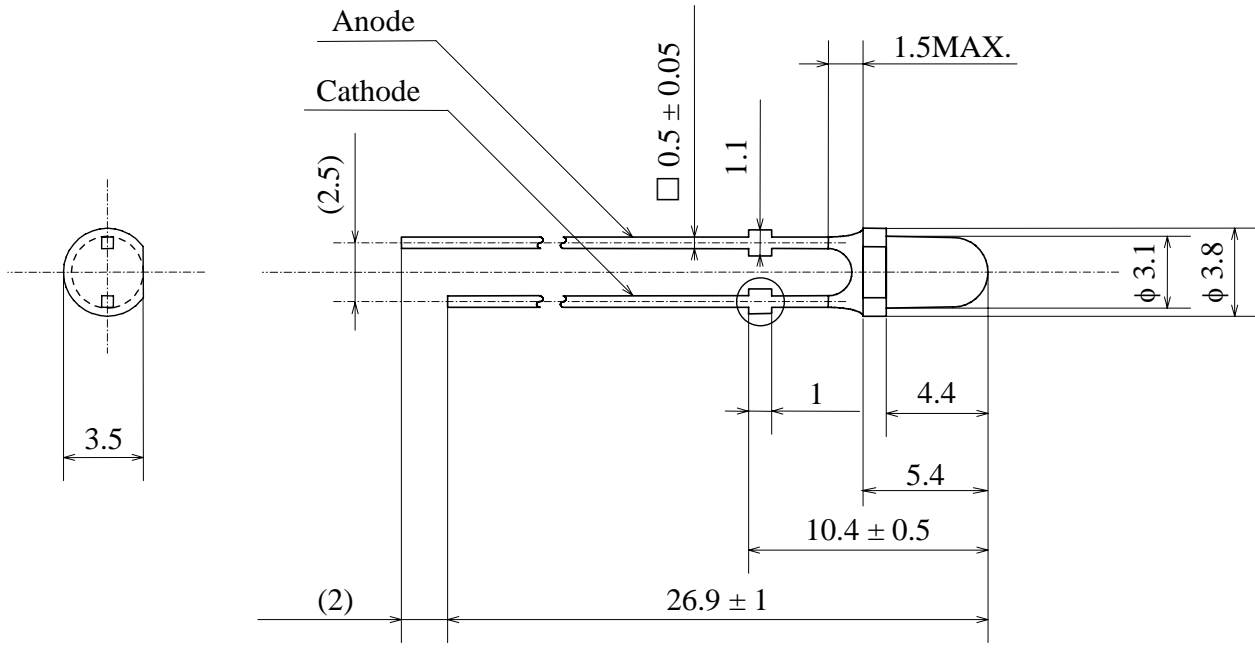

ITEM	MATERIALS
RESIN	Epoxy Resin (over Phosphor)
LEAD FRAME	Ag Plating Copper Alloy

Remark:

Please note that the bare copper alloy showing at the cut end of the lead frame may be corroded under certain conditions. LEDs have some sharp edges and points, particularly lead frames. Please handle with care so as to avoid injuries.

NICHIA CORPORATION	Model
	Title
	No.

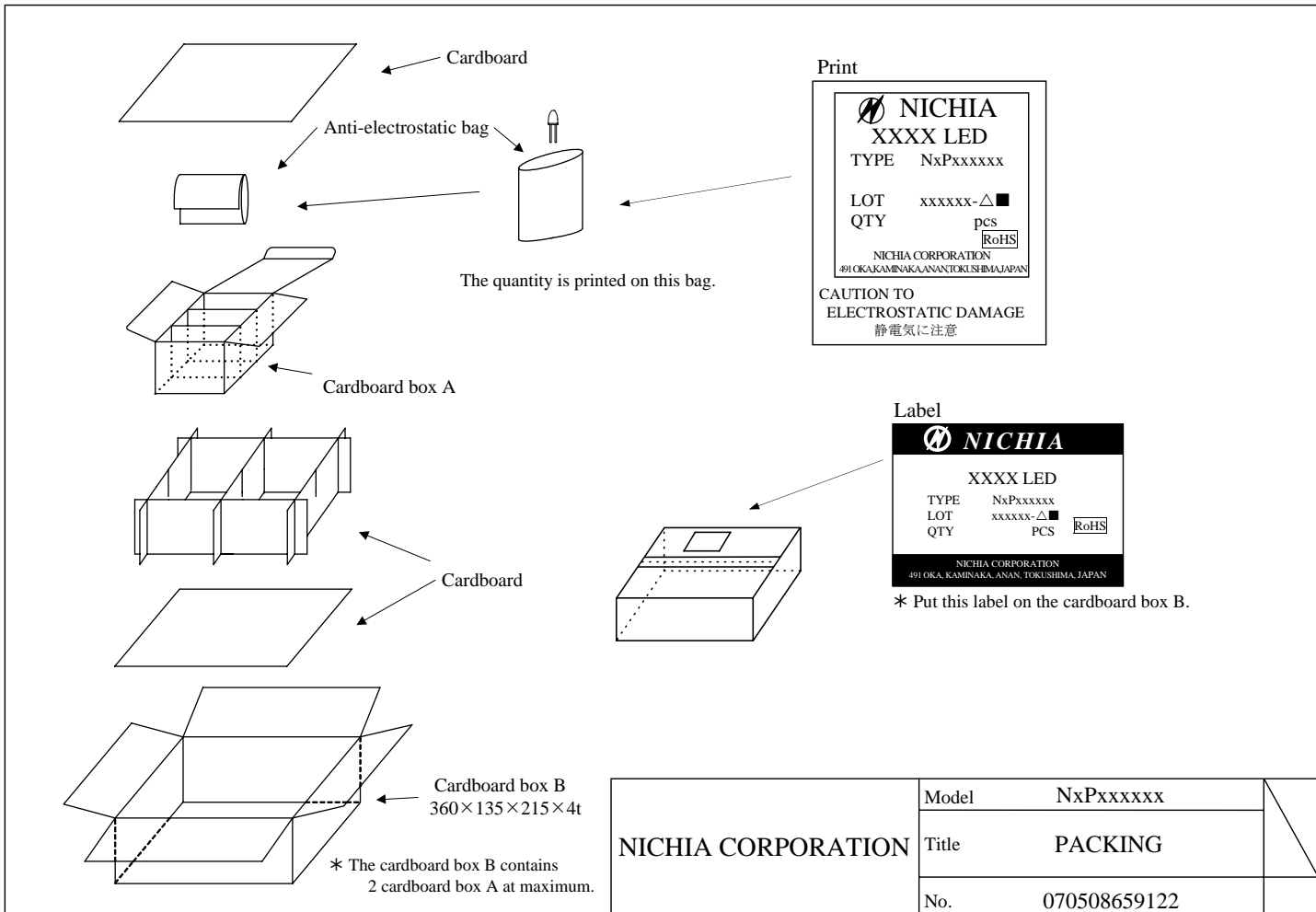
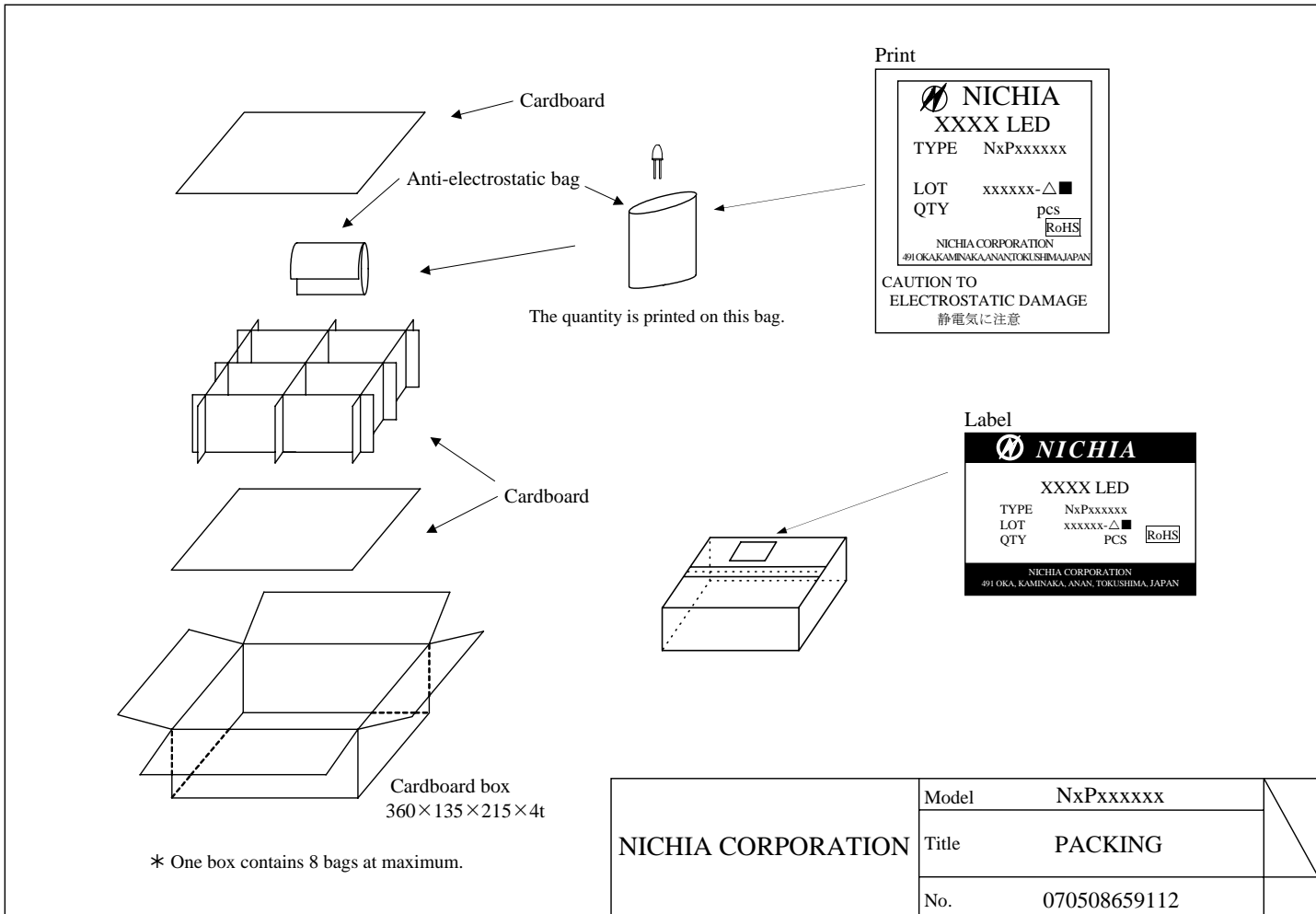

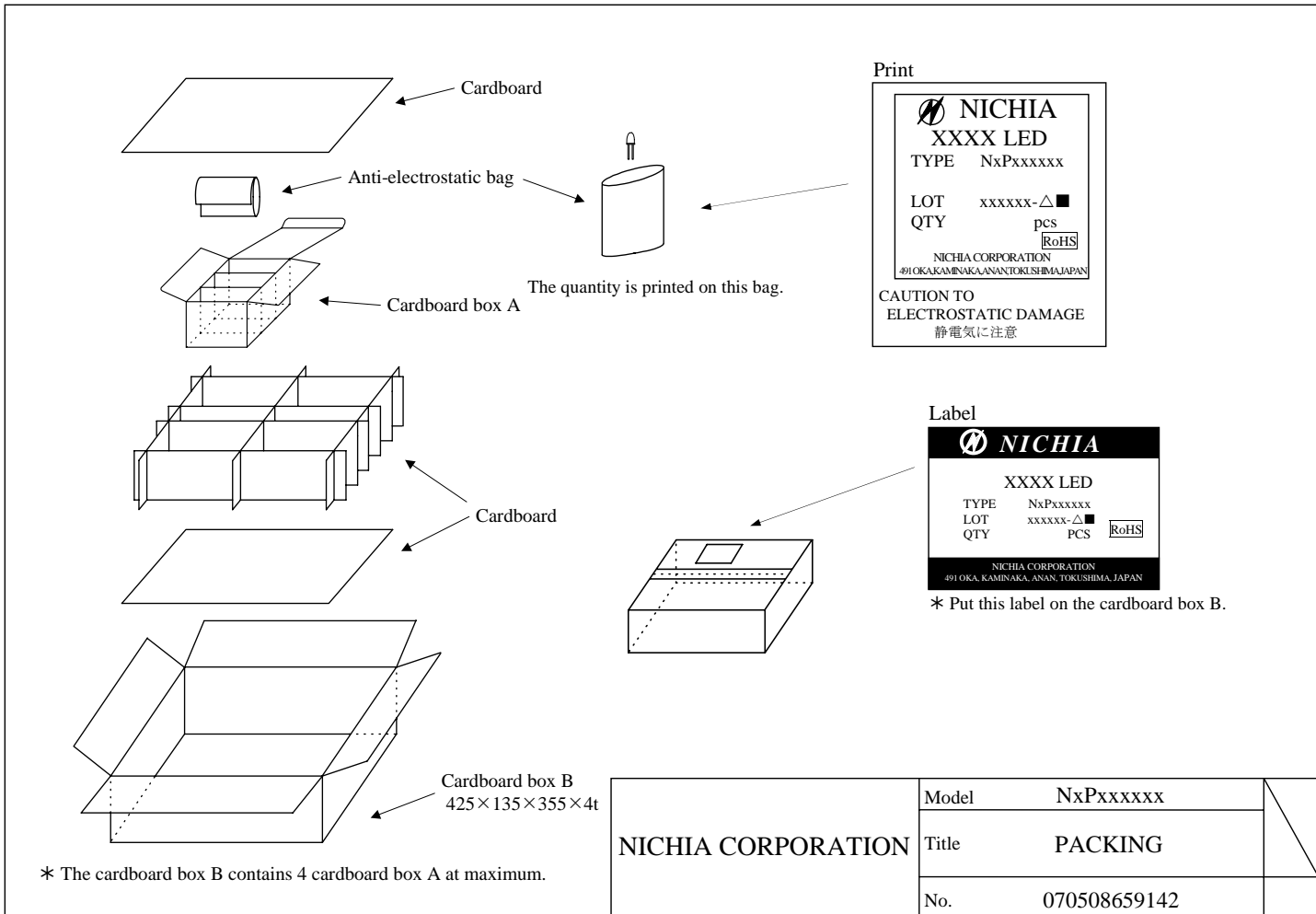
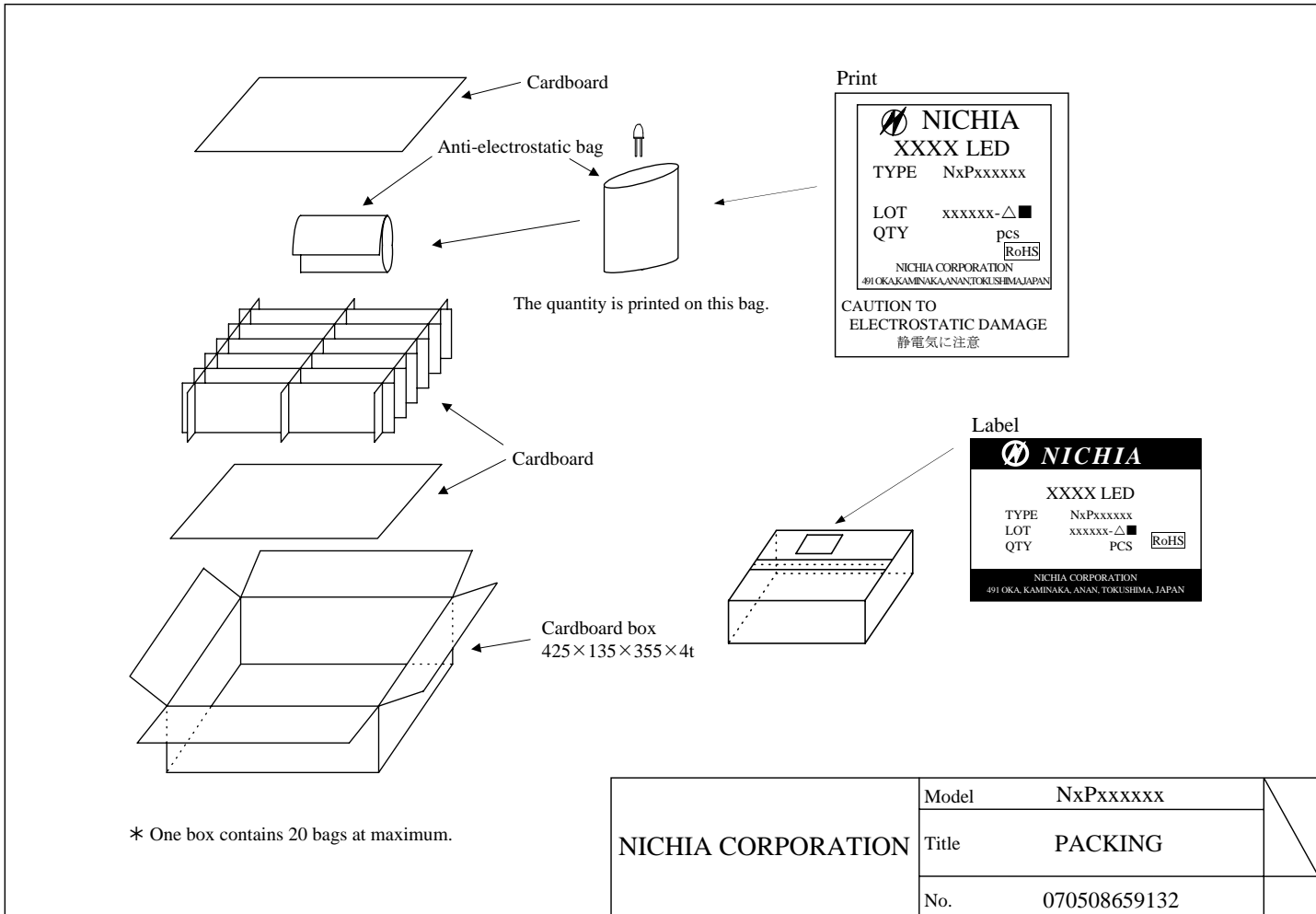

X-ON Electronics

Largest Supplier of Electrical and Electronic Components

Click to view similar products for [marl](#) manufacturer:

Other Similar products are found below :

[512-532-22](#) [512-532-23](#) [514-114-76](#) [661-508-64-40](#) [651-102-76](#) [671-066-75](#) [352-509-04](#) [352-505-04](#) [205-997-22-38](#) [524-521-21](#) [677-521-23-Y](#) [512-521-21](#) [671-064-75](#) [677-930-21-19](#) [209-521-23-38](#) [520-325-23](#) [651-114-21](#) [690-997-66](#) [508-930-22](#) [671-062-75](#) [525-095-21-50](#) [512-501-75](#) [531-532-63](#) [524-501-21](#) [514-111-75](#) [508-521-21](#) [520-324-23](#) [215-532-23-38](#) [671-063-23](#) [671-066-23](#) [215-532-76-38](#) [604-998-23](#) [662-303-04](#) [690-521-66](#) [671-064-23](#) [215-521-23-38](#) [677-501-22-R](#) [677-532-21-19](#) [698-532-63](#) [570-320-04-40](#) [209-930-23-38](#) [514-105-22](#) [512-501-22](#) [570-314-04-40](#) [528-532-22](#) [528-521-22](#) [512-997-22](#) [671-291-22](#) [660-320-64-40](#) [528-501-21](#)