

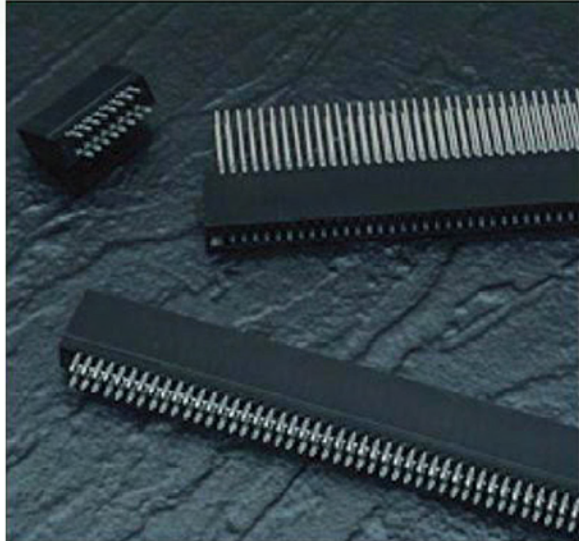

# SERIES 737

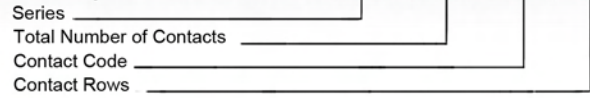

## Example Part Number 737 - 044 - 520 - 206



### Series 737

Total Number of Contacts	Contact Rows
005, 006, .... 043	Single Row
010, 012, .... 086	Dual Row

Contact Code	Description & Contact Point	Tail Length "G"
520	P.C. Tail Regular Point	.175 (4.45)
522	P.C. Tail Regular Point	.375 (9.53)
525	P.C. Tail High Point	.175 (4.45)
540	Wire Wrap Regular Point	.560 (14.22)
541	Wire Wrap Regular Point	.750 (19.05)
545	Wire Wrap High Point	.560 (14.22)

Contact Rows	Description
106	Single Row
206	Dual Row

### Ordering Code Notes

- 1) All connector sizes up to 43 contacts single row / 86 contacts dual row are available upon request
- 2) Make-before-break switching contacts, assembled in specific contact positions, are available upon request

## SPECIFICATIONS

Insulator Material: Thermoplastic Polyester, UL 94V-O.  
 Colour: Black

Contact Material: Copper, Nickel, Tin Alloy, Phosphor Bronze

Contact Plating: 30 Microinches (0.76 Microns) Gold on the Mating Area, Tin on the Compliant Section and Contact Tails, Nickel Underplate. Other Plating Options Available Upon Request

Current Rating: 3 Amperes Continuous

Contact Resistance: 10 Milliohms Maximum

Dielectric Withstanding Voltage: 1800 V AC rms at Sea Level Between Adjacent Contacts

Insulation Resistance: 5000 Megohms Minimum

Operating Temperature: -65 to +105 Degrees C

Daughter Board Insertion Force: 16oz (4.45N) Maximum per Contact Pair when Tested with a .070 (1.78) Thick Gauge

Daughter Board Withdrawal Force: 1 oz. (0.28N) Minimum per Contact Pair when Tested with a .054 (1.37) Thick Gauge

Contact Insertion Into Hole: 20lbs (89 N) Maximum

Contact Retention In Hole: 10lbs (44N) Minimum

Re-Insertability of Hole: 3 Times Minimum

## FEATURES

UL Recognized

.156 (3.96) Contact Spacing x .200 (5.08) Row Spacing

Accepts .062 (1.57) Nominal Thickness P.C. Board

High Profile Insulator Body, .645 (16.38) With End Notches

Ultra-Mate Compliant Section for Gas-Tight Reliable Connection in Plated Through Holes Eliminates Soldering Operations

Contact Termination Options include P.C Tail and .025 (0.64) Square Wire Wrap

Single or Dual Row Configurations

Accepts Between and In-Contact Polarizing Keys

Tools Available for Insulator and Contact Removal. Simple "Flat Rock" Tooling is Used for Connector Installation

IN-CONTACT  
POLARIZING KEY  
P/N 745-240-328

BETWEEN CONTACT  
POLARIZING KEY  
P/N 206-240-318



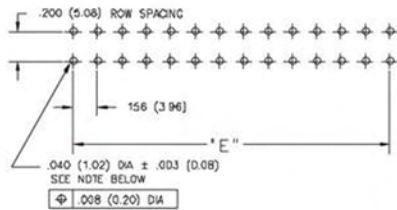
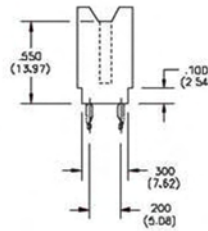
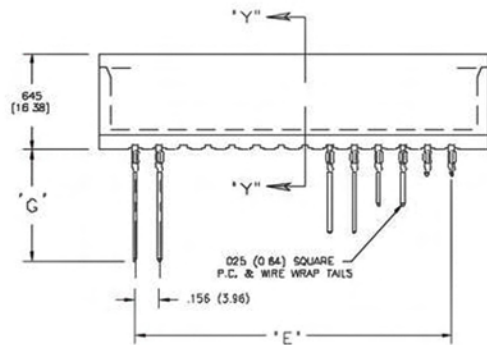
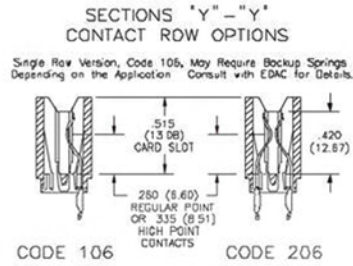
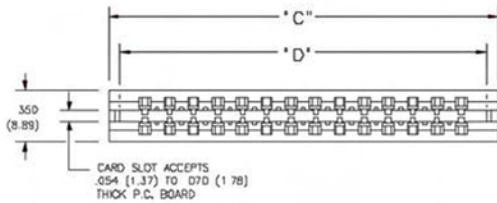

RECOMMENDED MOTHER BOARD HOLE PATTERN

TO OBTAIN OPTIMUM COMPLIANT SECTION PERFORMANCE,  
DRILL HOLES .0453 ± .001 (1.15 ± 0.03) DIAMETER  
COPPER PLATE, .001 (25.4 MICRONS) MINIMUM THICKNESS,  
FOLLOWED BY TIN PLATE TO PROVIDE FINISHED  
HOLES .040 ± .003 (1.02 ± 0.08) DIAMETER

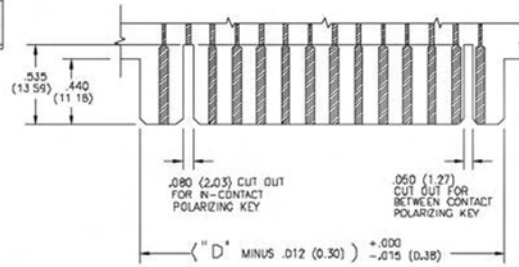

RECOMMENDED DAUGHTER BOARD

NUMBER OF CONTACTS		"C"		"D"		"E"	
Single	Dual	Inch	(mm)	Inch	(mm)	Inch	(mm)
5	10	1.246	(31.65)	1.100	(27.94)	.780	(19.81)
6	12	1.402	(35.61)	1.256	(31.90)	.936	(23.77)
10	20	2.026	(51.46)	1.880	(47.75)	1.560	(39.62)
15	30	2.806	(71.27)	2.660	(67.56)	2.340	(59.44)
18	36	3.274	(83.16)	3.128	(79.45)	2.808	(71.32)
20	40	3.586	(91.08)	3.440	(87.38)	3.120	(79.25)
22	44	3.898	(99.01)	3.752	(95.30)	3.432	(87.17)
25	50	4.366	(110.90)	4.220	(107.19)	3.900	(99.06)
28	56	4.834	(122.78)	4.688	(119.08)	4.368	(110.95)
30	60	5.146	(130.71)	5.000	(127.00)	4.680	(118.87)
31	62	5.302	(134.67)	5.156	(130.96)	4.836	(122.83)
33	66	5.614	(142.60)	5.468	(138.89)	5.148	(130.76)
36	72	6.082	(154.48)	5.936	(150.77)	5.616	(142.65)
43	86	7.174	(182.22)	7.028	(178.51)	6.708	(170.38)

Dimensions of Other Connector Sizes are Listed

## X-ON Electronics

Largest Supplier of Electrical and Electronic Components

*Click to view similar products for [Standard Card Edge Connectors](#) category:*

*Click to view products by [EDAC](#) manufacturer:*

Other Similar products are found below :

[6565204-6](#) [PKC-156](#) [1437274-4](#) [147889-1](#) [1489165-4](#) [EBT156-12B1X](#) [EBT15622B2X](#) [EBT156-22R2W](#) [1-582587-1](#) [1-582589-1](#) [2-6437275-9](#) [284-0102-12100](#) [306022901000000](#) [307-012-502-202](#) [307-024-526-201](#) [307-056-520-300](#) [307-080-526-208](#) [1926088-2](#) [245-062-520-350](#) [287-0032-12101](#) [306-010-500-112](#) [306-028-525-102](#) [306-240-318](#) [307-036-502-202](#) [307-036-521-301](#) [307-072-526-202](#) [345-060-559-303](#) [368-004-520-201](#) [392-008-559-201](#) [534671-1](#) [5-530501-5](#) [341-240-317](#) [345-029-520-300](#) [345-030-500-301](#) [345-044-500-300](#) [345-220-058](#) [346-240-318](#) [357-030-526-201](#) [387-012-523-300](#) [395-044-520-300](#) [395-100-524-300](#) [50-12B-10](#) [50-6SN-5](#) [09-07-2032](#) [10035388-106LF](#) [10035388-802LF](#) [10115859-011LF](#) [10122859-009LF](#) [101269333204245CLF](#) [10127905-B04B24BLF](#)