

Connectors according to DIN 41612 / IEC 60603-2

Type B

Female connector

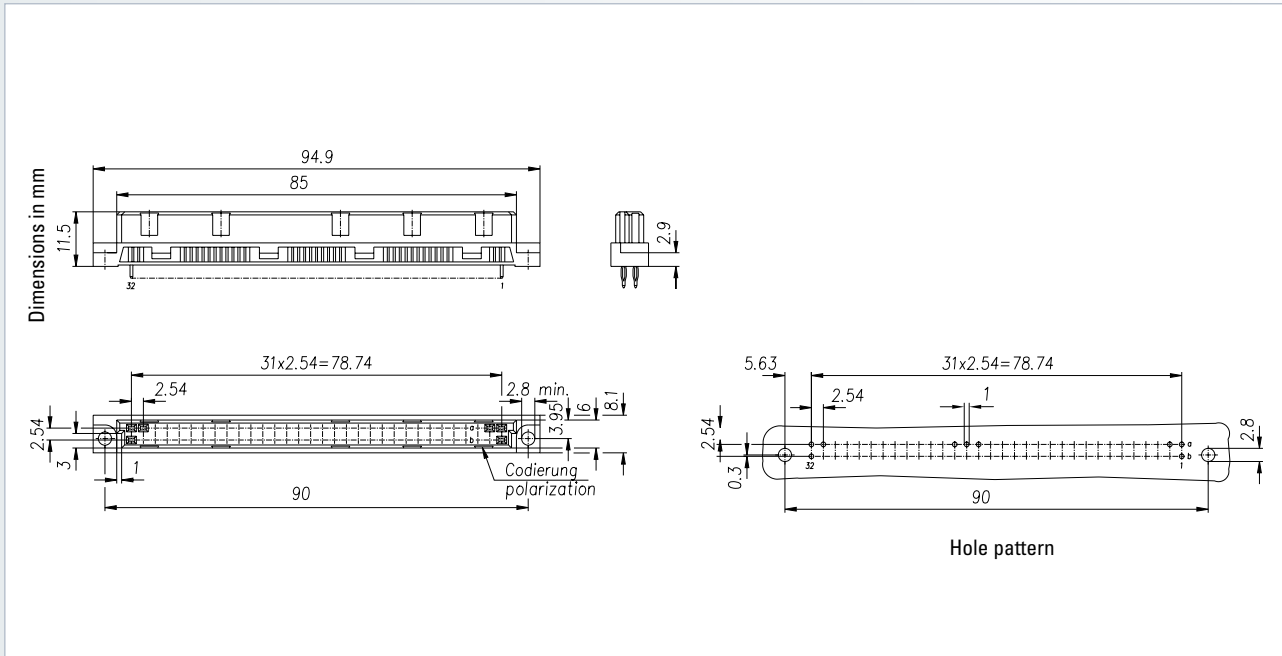
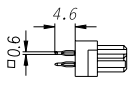
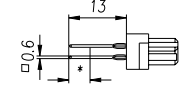
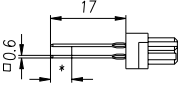
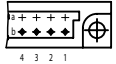
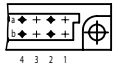
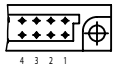

No. of contacts	Contact arrangement	Press-fit technology – Performance level II		
		Termination length		
				
Part number				
32		302-63014-02	302-65015-03	302-65016-04
32		102-63024-xx	102-65025-xx	102-65026-xx
64		302-63064-02	302-65065-03	302-65066-04

Accessories – Press-fit tool (see page 208) – Support tool (see page 209) – Coding accessories (see page 160)	On request – Performance levels I + III or customer-specific – Special contact length – Alternative surface Sn, e.g. for WireWrap	Options – Without flange – Contact arrangement (see page 162)
Note – * Rear mating zone Ni, Au	Ordering note Only for 102 – PCB 1.5 to 2.0 mm = xxx-xxxx-01 termination length = 3.2 mm – PCB 2.0 to 2.8 mm = xxx-xxxx-02 termination length = 4.6 mm – PCB > 2.8 mm = xxx-xxxx-03 termination length = 4.6 mm	Cross reference – Type B with IDC (see page 156)

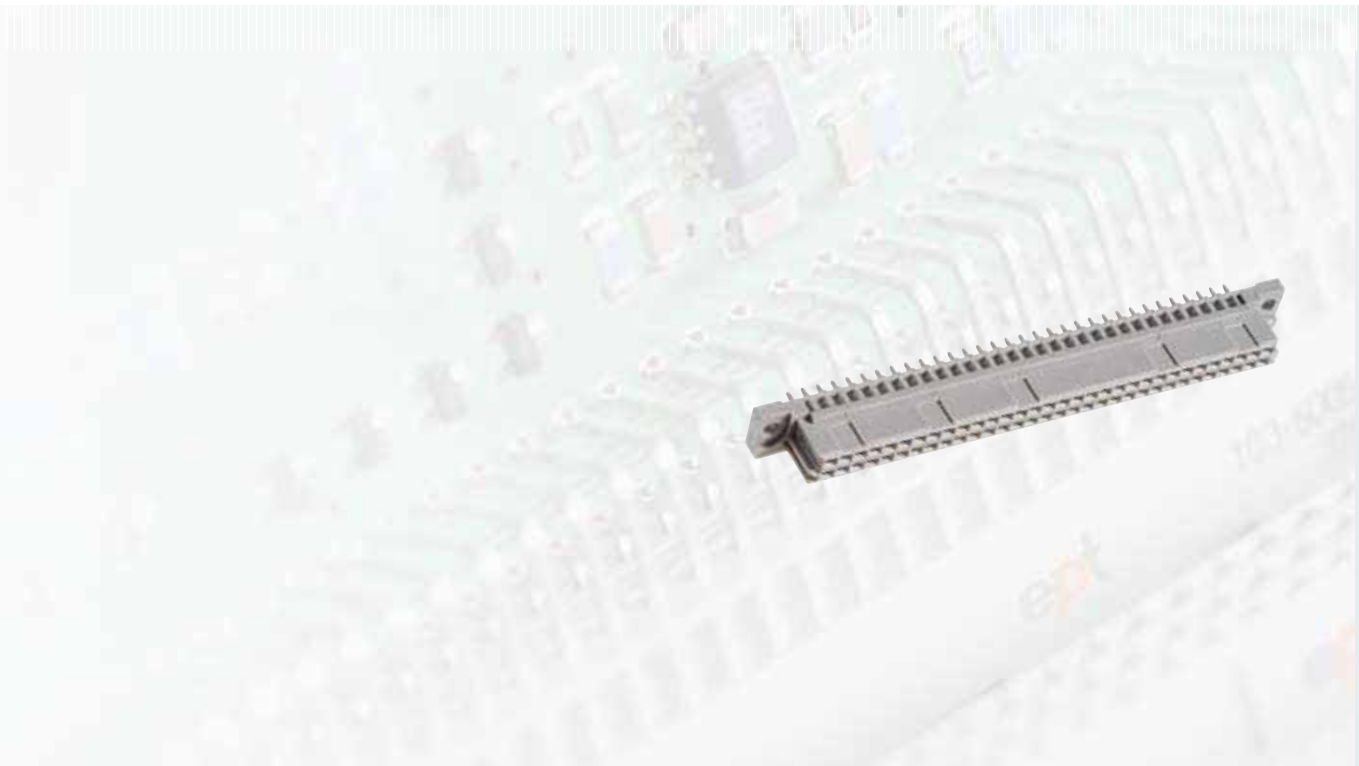

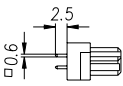
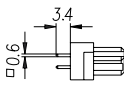
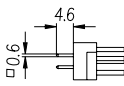
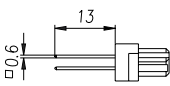
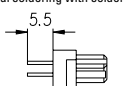
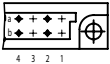
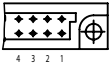
No. of contacts	Contact arrangement	Solder technology – Performance level II				
		Termination length				
						
Part number						
32		102-40024	–	–	102-40026	102-40044
64		302-40064-05	302-40064-01	302-40064-02	302-40065-03	102-40074

<p>Accessories</p> <ul style="list-style-type: none"> – Coding accessories (see page 160) 	<p>On request</p> <ul style="list-style-type: none"> – Performance levels I + III or customer-specific – Special contact length – Also in THTR 	<p>Options</p> <ul style="list-style-type: none"> – Board lock (see page 159) – Contact arrangement (see page 162)
<p>Cross reference</p> <ul style="list-style-type: none"> – Type B with IDC (see page 156) 		

X-ON Electronics

Largest Supplier of Electrical and Electronic Components

Click to view similar products for [FFC & FPC Connectors](#) category:

Click to view products by [EPT manufacturer](#):

Other Similar products are found below :

[HFW11R-1STE1H1LF](#) [FH29B-100S-0.2SHW\(99\)](#) [FA5S008HP1](#) [FH29B-120S-0.2SHW\(99\)](#) [FH29B-80S-0.2SHW\(99\)](#) [FHS-16](#) [FPH-2022G](#)
[52610-1075](#) [52610-1275](#) [52610-1934](#) [XF3M\(1\)-1415-1B-R100](#) [501864-3091-TR225](#) [0525594033](#) [086210010340800](#) [086222026001800](#)
[52271-2869-CUT-TAPE](#) [62674-201121DLF](#) [62684-36210E9ALF](#) [52610-1675](#) [52746-1671-TR250](#) [10051922-2810EHLF](#) [6-520415-9](#)
[BD021-09A-A1-0350-0200-0550-LD](#) [SFV6R-1STE9HLF](#) [XF3M-2915-1B-R100](#) [1658549-1](#) [62674-221121ALF](#) [46214008010800](#)
[046298003000883](#) [151660622](#) [842-816-2630-035](#) [AYF530665TA](#) [AYF351525](#) [046296011930846+](#) [AYF352325A](#) [046254020000800+](#)
[FH19C-13S-0.5SH\(99\)](#) [FH39J-51S-0.3SHW\(99\)](#) [AYF355125A](#) [AYF530365TA](#) [FH29B-44S-0.2SHW\(99\)](#) [SFW5R-2STAE9LF](#) [AYF351125A](#)
[AYF350725A](#) [62684-502100AHLF](#) [FH39-61S-0.3SHW\(99\)](#) [AYF414035A](#) [10064555-172520HLF](#) [AYF212335A](#) [504754-2500](#)