

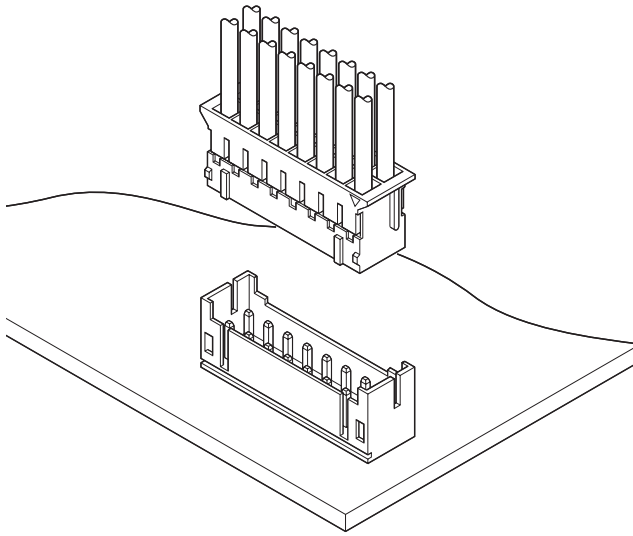

PHD CONNECTOR

2.0mm pitch/Disconnectable Crimp style connectors



This is a 2.0mm pitch, crimp style, double-row, wire-to-board connector. It is designed to meet the demand for high-density and low-profile connection.

- Compact
- Reliable contacts
- Fully shrouded header

Specifications

- Current rating: 3A AC, DC (AWG #22)
- Voltage rating: 250V AC, DC
- Temperature range: -25°C to +85°C
(including temperature rise in applying electrical current)
- Contact resistance: Initial value/ 10m Ω max.
After environmental testing/ 20m Ω max.
- Insulation resistance: 1,000M Ω min.
- Withstanding voltage: 800V AC/minute
- Applicable wire: AWG #28 to #22
- Applicable PC board thickness: 1.6mm

- * Compliant with RoHS.
- * Refer to "General Instruction and Notice when using Terminals and Connectors" at the end of this catalog.
- * Contact JST for details.

Standards

Recognized E60389

Certified LR20812

Top entry type

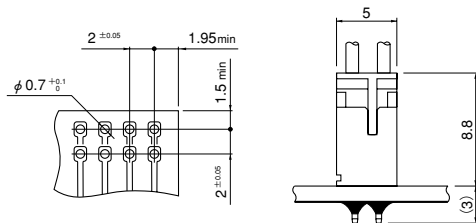

Side entry type

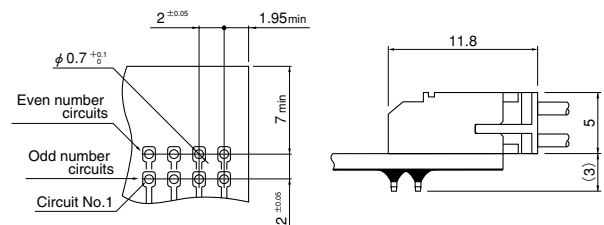

Note: 1. The above figure is the figure viewed from soldering side.

2. Tolerances are non-cumulative: ±0.05mm for all centers.

3. Hole dimensions differ according to the kind of PC board and piercing method. If PC boards made of hard material are used, the hole dimensions should be larger. The dimensions above should serve as a guideline. Contact JST for details.

Contact

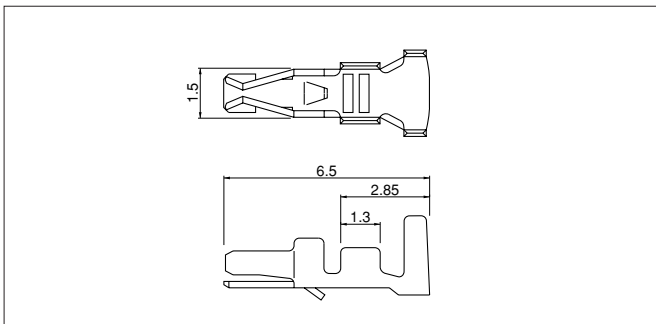

Model No.	Applicable wire		Insulation O.D. (mm)	Qty / reel
	mm ²	AWG #		
SPHD-002T-P0.5	0.08~0.21	28~24	0.9~1.5	8,000
SPHD-001T-P0.5	0.13~0.33	26~22	1.0~1.5	

Material and Finish

Phosphor bronze, tin-plated (reflow treatment)

RoHS compliance

Contact	Crimping machine	Applicator		
		Crimp applicator	Dies	Crimp applicator with dies
SPHD-002T-P0.5	AP-K2N	MKS-L-10	MK/SPHD-002-05	APLMK SPHD002-05
		*MKS-SC-10	SC/SPHD-002-05	APLSC SPHD002-05

Contact	Crimping machine	Applicator		
		Crimp applicator	Dies	Crimp applicator with dies
SPHD-001T-P0.5	AP-K2N	MKS-L-10	MK/SPHD-001-05	APLMK SPHD001-05
		*MKS-SC-10	SC/SPHD-001-05	APLSC SPHD001-05

Note: *Strip-crimp applicator

PHD CONNECTOR

Housing

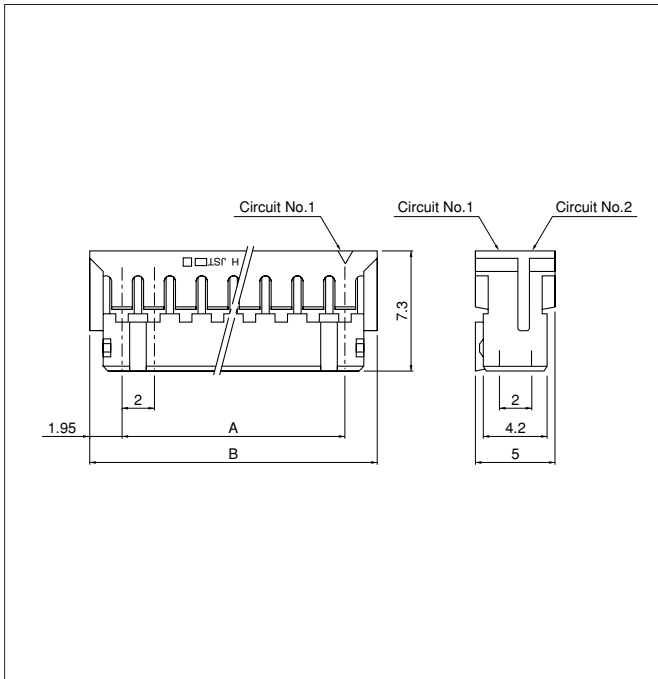

Circuits	Model No.	Dimensions (mm)		Q'ty / bag
		A	B	
8	PHDR-08VS	6.0	9.9	1,000
10	PHDR-10VS	8.0	11.9	1,000
12	PHDR-12VS	10.0	13.9	1,000
14	PHDR-14VS	12.0	15.9	1,000
16	PHDR-16VS	14.0	17.9	1,000
18	PHDR-18VS	16.0	19.9	1,000
20	PHDR-20VS	18.0	21.9	1,000
22	PHDR-22VS	20.0	23.9	1,000
24	PHDR-24VS	22.0	25.9	1,000
26	PHDR-26VS	24.0	27.9	1,000
28	PHDR-28VS	26.0	29.9	1,000
30	PHDR-30VS	28.0	31.9	1,000
32	PHDR-32VS	30.0	33.9	1,000
34	PHDR-34VS	32.0	35.9	1,000

Material

PA 66, UL94V-0, natural (white)

RoHS compliance

<For reference> As the color identification, the following alphabet shall be put in the underlined part. For availability, delivery and minimum order quantity, contact JST.

ex. **PHDR-10VS**

S...natural (white)

K...black Y...yellow E...blue R...red

Shrouded header

Top entry type

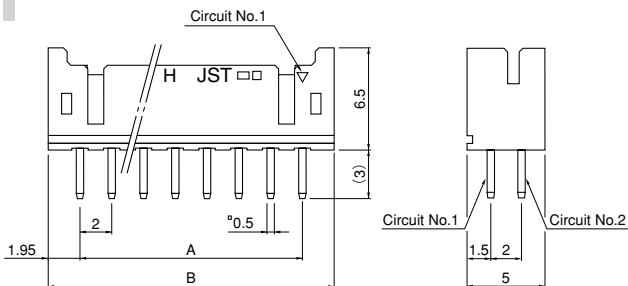

Side entry type

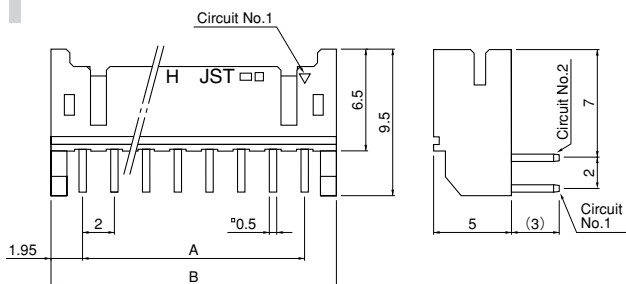

Circuits	Model No.				Dimensions (mm)		Q'ty / box	
	Glass-filled nylon		Nylon		A	B	Top entry type	Side entry type
	Top entry type	Side entry type	Top entry type	Side entry type				
8	B8B-PHDSS	S8B-PHDSS	—	—	6.0	9.9	500	500
10	B10B-PHDSS	S10B-PHDSS	B10B-PHDSS-B	S10B-PHDSS-B	8.0	11.9	500	500
12	B12B-PHDSS	S12B-PHDSS	B12B-PHDSS-B	S12B-PHDSS-B	10.0	13.9	500	500
14	B14B-PHDSS	S14B-PHDSS	B14B-PHDSS-B	S14B-PHDSS-B	12.0	15.9	500	250
16	B16B-PHDSS	S16B-PHDSS	B16B-PHDSS-B	S16B-PHDSS-B	14.0	17.9	500	250
18	B18B-PHDSS	S18B-PHDSS	B18B-PHDSS-B	S18B-PHDSS-B	16.0	19.9	500	250
20	B20B-PHDSS	S20B-PHDSS	B20B-PHDSS-B	S20B-PHDSS-B	18.0	21.9	250	250
22	B22B-PHDSS	S22B-PHDSS	B22B-PHDSS-B	S22B-PHDSS-B	20.0	23.9	250	250
24	B24B-PHDSS	S24B-PHDSS	B24B-PHDSS-B	S24B-PHDSS-B	22.0	25.9	250	200
26	B26B-PHDSS	S26B-PHDSS	B26B-PHDSS-B	S26B-PHDSS-B	24.0	27.9	250	200
28	B28B-PHDSS	S28B-PHDSS	B28B-PHDSS-B	S28B-PHDSS-B	26.0	29.9	250	200
30	B30B-PHDSS	S30B-PHDSS	B30B-PHDSS-B	S30B-PHDSS-B	28.0	31.9	250	200
32	B32B-PHDSS	S32B-PHDSS	B32B-PHDSS-B	S32B-PHDSS-B	30.0	33.9	250	200
34	B34B-PHDSS	S34B-PHDSS	B34B-PHDSS-B	S34B-PHDSS-B	32.0	35.9	250	200

Material and Finish

Post: Copper alloy, copper-undercoated, tin-plated (reflow treatment)

Wafer: Glass-filled PA 66, UL94V-0, natural (ivory)

PA 66, UL94V-0, natural (white)

RoHS compliance This product displays (LF)(SN) on a label.

<For reference> As the color identification, the following alphabet shall be put in the underlined part. For availability, delivery and minimum order quantity, contact JST.

ex. **B10B-PHDSS**

S...natural (ivory)

ex. **B10B-PHDSS-B**

S...natural (white)

K...black Y...yellow E...blue R...red

X-ON Electronics

Largest Supplier of Electrical and Electronic Components

Click to view similar products for [Headers & Wire Housings](#) category:

Click to view products by [JST](#) manufacturer:

Other Similar products are found below :

[95000-104TRLF](#) [10135584-644402LF](#) [DF62W-EP2022PCA](#) [95000-106TRLF](#) [DF62W-2022SCA](#) [DF62W-EP2022PC](#) [2203348](#) [DF62W-2022SC](#) [1084018](#) [1029039](#) [1084017](#) [802-10-012-10-002000](#) [1112640](#) [1112639](#) [891-007-9SS-BST1T](#) [000-34000](#) [0008550134](#) [0009482033](#) [0009507031](#) [57102-F02-18ULF](#) [57102-S06-03LF](#) [57202-S52-04LF](#) [PCN6-15S-2.5E](#) [0039019024](#) [58102-G61-06LF](#) [582553-1](#) [0009485154](#) [0009508121](#) [0022285053](#) [0050291907](#) [018731A](#) [LY20-4P-DT1-P1E-BR](#) [02.125.8002.8](#) [60101931](#) [60598-1 \(Cut Strip\)](#) [M1625-3R/100](#) [61062-3](#) [61082-181009](#) [CSU011177004](#) [636-1427](#) [638009-1](#) [641938-9](#) [641991-4](#) [644168-1](#) [644827-2](#) [647662-1](#) [65039-019ELF](#) [65692-001LF](#) [65781-018](#) [65781-047](#)