



UM10943

NXQ1TXH5DB1401 one-chip 5 V Qi wireless transmitter demo board

Rev. 1 — 13 April 2016

User manual

Document information

Info	Content
Keywords	NXQ1TXH5DB1401, NXQ1TXH5/101, NXQ1TXL5/101, Qi, CoolFlux DSP, wireless charger, high frequency, A5, A11, A12, A16, Q1, WPC 1.2
Abstract	This user manual describes the NXQ1TXH5DB1401 demo board. The hardware is described and a brief description for operating the board is given.



Revision history

Rev	Date	Description
v.1	20160413	first issue

Contact information

For more information, please visit: <http://www.nxp.com>

For sales office addresses, please send an email to: salesaddresses@nxp.com

1. Introduction

WARNING

Lethal voltage and fire ignition hazard



The non-insulated high voltages that are present when operating this product, constitute a risk of electric shock, personal injury, death and/or ignition of fire.

This product is intended for evaluation purposes only. It shall be operated in a designated test area by personnel qualified according to local requirements and labor laws to work with non-insulated mains voltages and high-voltage circuits. This product shall never be operated unattended.

This user manual describes the NXQ1TXH5DB1401 wireless power transmitter WPC1.2 board designed for A11 Qi coils. This board is based on the NXQ1TXH5/101 fully integrated wireless power transmitter IC for Qi compliant 5 V low-power transmitters of NXP Semiconductors.

The NXQ1TXH5/101 comes in a 5 mm × 5 mm HVQFN32 package. Necessary information is given for a quick start-up of the NXQ1TXH5DB1401 demo board (see [Section 4.1](#)). For more information about the NXQ1TXH5/101 IC, see the NXQ1TXH5/101 data sheet ([Ref. 1](#)). For general application information, see the application note ([Ref. 2](#)).

1.1 NXQ1TXH5/101 features

- Single-chip WPC 1.2 Qi-compliant device for A5/A11/A12/A16 5 V single-coil low-power transmitter
- Operates from 5 V supply
- Integrated high-efficiency full-bridge power stage with low EMI radiation meeting EN55022 radiated and conducted emission limits
- Very few external components required, minimizing cost and board space
- Extremely low-power receiver detection circuitry by integrating an analog ping circuit; standby (wait state) power 10 mW (typical)
- Power stage protected against overcurrents and overtemperature
- Dual-channel Amplitude Shift Keying (ASK) demodulation
- Demodulates communication packets from Qi-compliant receivers
- PID regulation for power drive and control
- Internal 1.8 V digital supply generation
- LED (×2) and buzzer outputs
- NTC input for external temperature check and protection
- On-chip thermal protection
- Small HVQFN 32-pin package (5 mm × 5 mm) with 0.5 mm pitch
- FOD with WPC receiver versions 1.2 and 1.1 and for legacy receiver support; when a WPC 1.0 receiver is detected, FOD is switched off automatically
- The FOD configuration can be adjusted using external resistors to compensate for application differences to meet Qi certification requirements
- Smart Power Limiting (SPL) function to adapt to power-limited 5 V supplies

- Static Power Reduction (SPR) function to limit power consumption
- Peak efficiency > 75 %
- Excellent low power (< 2 W) transfer efficiency; ideal for charging wearables

1.2 NXQ1TXH5DB1401 demo board features

The NXQ1TXH5DB1401 demo board is primarily designed to demonstrate the NXQ1TXH5/101 operation and performance. Nevertheless, the board can also be used for development purposes.

The NXQ1TXH5DB1401 board is a good starting point for a fully qualified mass producible NXQ1TXH5/101-based application. It contains the following components and features:

- NXQ1TXH5/101 integrated wireless power transmitter IC
- A red and green LED serving as functional (user interface) indicators
- Resonant capacitors (NP0 type) which together with the Qi transmitter coil make up the LC tank
- A female micro USB receptacle for powering the board with a standard USB charger with rating of 2000 mA or more
- A11 Qi transmitter coil
- Two resistors for FOD configuration setting
- A resistor for LED/buzzer mode setting
- A resistor for SPR and SPL configuration
- Jumpers that allow the LEDs to operate in 'normal' and 'inverted' mode
- Optional NTC connections to measure the coil temperature
- Optional buzzer connection
- Optional communication interface, accessible via test pads (beyond the scope of this manual)

1.3 NXQ1TXH5/101 application information

All relevant general application information and details about general operation and configuration of the NXQ1TXH5/101 application can be found in the NXQ1TXH5/101 application note ([Ref. 2](#)).

2. Specifications

Table 1. NXQ1TXH5DB1401 demo board specifications

Symbol	Description	Value
V_{CC}	supply voltage (DC)	5 V; $\pm 5\%$
$I_{DC(max)}$	maximum DC input current	2 A
f_{oper}	operating frequency	110 kHz to 205 kHz
η	efficiency (of the charger)	87 % (typical)
EMI	ElectroMagnetic Interference	CISPR22 (EN55022)

3. Board photograph

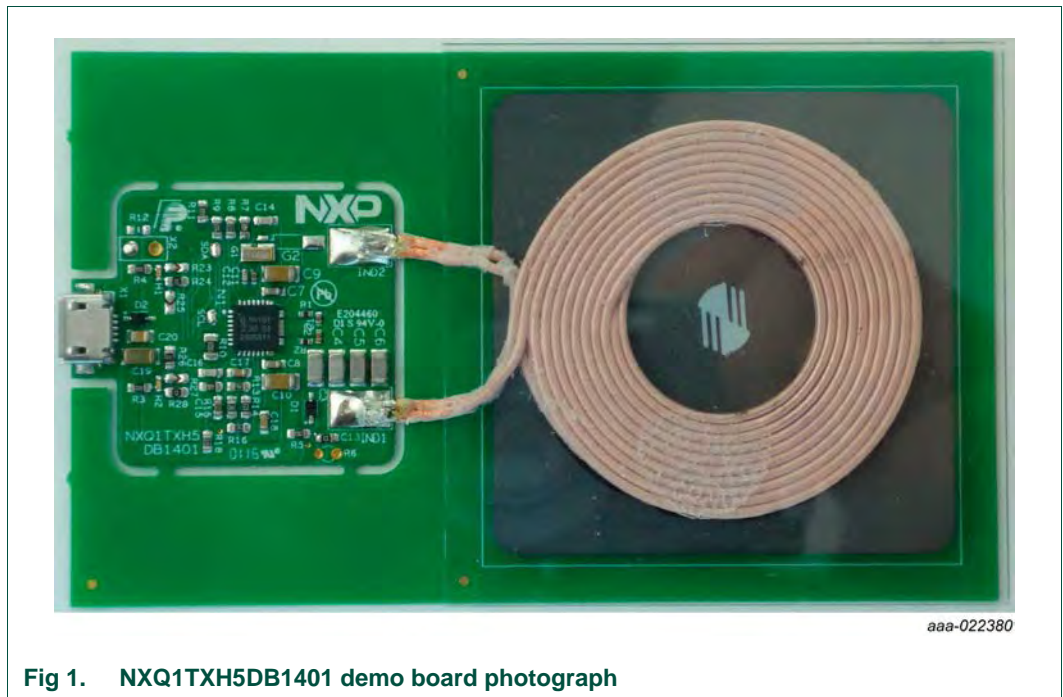

4. Functional description

4.1 Setup and operation of the NXQ1TXH5DB1401 demo board

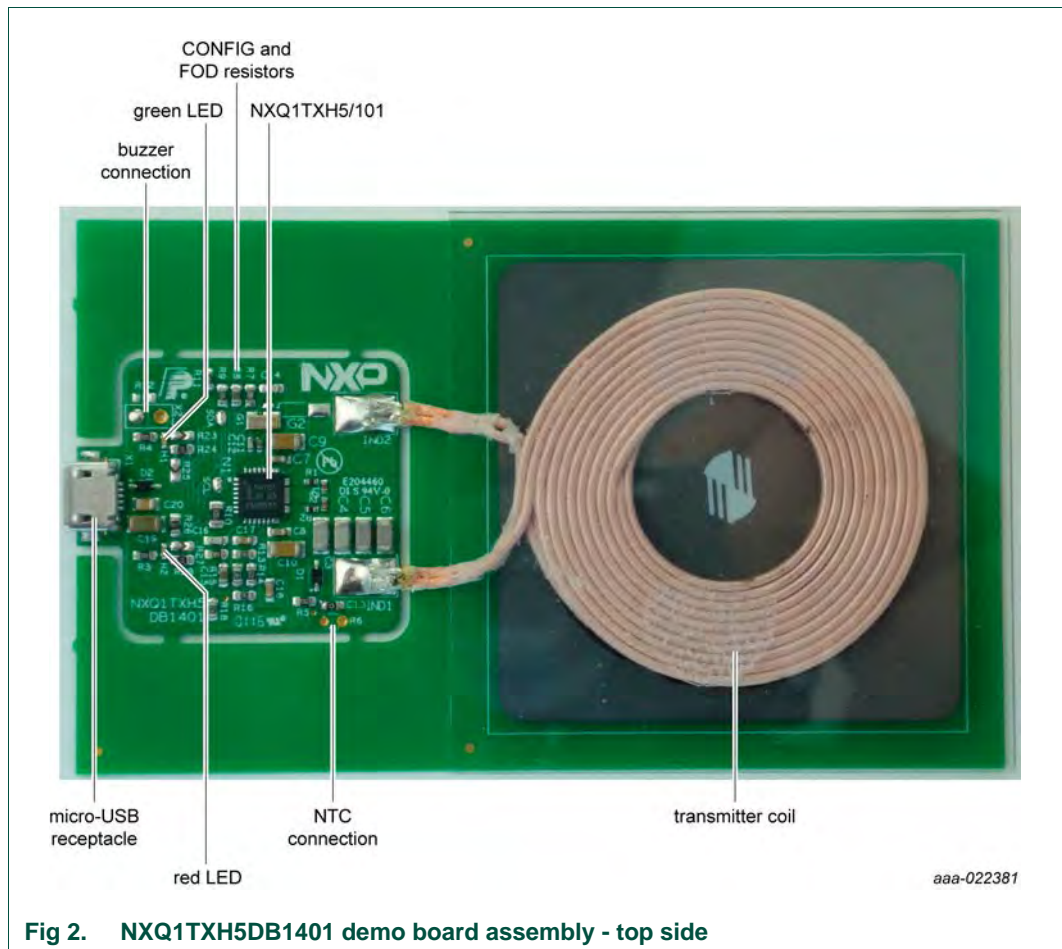

Fig 2. NXQ1TXH5DB1401 demo board assembly - top side

4.1.1 NXQ1TXH5DB1401 demo board connections

The NXQ1TXH5DB1401 demo board incorporates an on-board female micro-USB receptacle (X1). 5 V is supplied to the board via this connector. To feed the board, a standard USB adapter (5 V/2 A) can be used. To minimize the voltage drop across the cable, use an AWG20 USB supply cable. Preferably, the USB adapter has cable compensation to compensate for the voltage drop across the USB supply cable.

To connect an AC buzzer, the two-wire connection X2 can be used. When the buzzer is mounted, resistor R12 (1 k Ω) must be mounted as well. The configuration setting using resistors R7 and R11 determines the behavior of the buzzer. For more information, see [Section 4.1.3](#) and the application note ([Ref. 2](#)).

PCB test pads for communication with the NXQ1TXH5/101 are available on the top side and the bottom side of the PCB. When application support is required, these pads are essential. However, communication with the NXQ1TXH5/101 IC is outside the scope of this manual.

4.1.2 Configuration

The operation behavior of the NXQ1TXH5/101 is set using resistors R7 to R11. The IC reads its configuration each time the charger starts charging by pulling the CNF1, CNF2, CNF3, and CNF4 outputs low, while measuring the voltage that is being produced on pin CNF_IN. In this way, the resistor combinations R7/R11, R8/R11, R9/R11 and R10/R11 define the NXQ1TXH5/101 operating characteristics.

4.1.2.1 Smart Power Limiting (SPL) and Smart Power Reduction (SPR) (pin CNF1)

Resistor combination R7/R11 sets the SPR and SPL behavior of the NXQ1TXH5/101 IC. The SPR/SPL operational behavior is read by measuring the voltage on the CNF_IN pin while CNF1 is low.

$$V_{CNF_IN} = \frac{R7}{R7 + R11} \cdot V_{DDP} \tag{1}$$

[Table 2](#) lists the SPR level and SPL status resulting from a certain V_{CNF_IN} voltage. In the table, V_{DDP} (the supply voltage) is assumed to be 5.0 V. However, levels are automatically compensated for deviations/changes in V_{DDP} .

Table 2. SPR and SPL

Input voltage on pin CNF_IN (CNF1 is active)	SPR level	SPL function
$V_{CNF_IN} < 0.04 \text{ V}$	off (maximum 2 A)	off
$0.085 \text{ V} < V_{CNF_IN} < 1.29 \text{ V}$	$SPR = (V_{CNF_IN} / 1.2) + 0.43 \text{ (A)}$ ^[1]	on
$1.335 < V_{CNF_IN} \leq V_{DDP}$	off (maximum 2 A)	on

[1] This formula assumes $V_{DDP} = 5 \text{ V}$; the results are automatically adjusted to compensate for changes in the supply voltage level. CNF_IN in V.

For more information about SPR and SPL, see the NXQ1TXH5/101 data sheet ([Ref. 1](#)) and the application note ([Ref. 2](#)).

4.1.2.2 FOD (pins CNF2 and CNF3)

The NXQ1TXH5/101 features FOD functionality according to the WPC 1.2 and WPC 1.1 standard. When the NXQ1TXH5/101 IC notices that too much power is lost in the wireless power transfer path (e.g. a metal object like a coin), the IC enters the FOD fault state.

Two parameters determine the behavior of the FOD mechanism: FOD_E and FOD_T. FOD_E sets an equivalent loss resistance (in mΩ). FOD_T specifies the acceptable FOD power loss threshold margin.

The FOD_E value is read by measuring the voltage on the CNF_IN pin while CNF2 is low. So, FOD_E is set with resistor combination R8/R11.

$$V_{CNF_IN} = \frac{R8}{R8 + R11} \cdot V_{DDP} \tag{2}$$

[Table 3](#) shows how FOD_E results from a certain V_{CNF_IN} voltage. In the table, V_{DDP} (the supply voltage) is assumed to be 5.0 V. However, levels are automatically compensated for deviations/changes in V_{DDP} .

Table 3. CNF2: FOD_E parameter

Input voltage on pin CNF_IN (CNF2 is active)	FOD correction factor
$V_{CNF_IN} < 0.04\text{ V}$	default value for FOD correction (280)
$85\text{ mV} < V_{CNF_IN} \leq 1.29\text{V}$	$FOD_E = 400 \times (V_{CNF_IN} / 1.5) + 135$ ^[1]
$1.335\text{ V} < V_{CNF_IN} \leq V_{DDP}$ (VDDP is maximum input level)	reserved

[1] This equation assumes $V_{DDP} = 5\text{ V}$. The results are automatically adjusted to compensate for changes in the supply voltage level.

The FOD_T value is read by measuring the voltage on the CNF_IN pin while CNF3 is low. So, the FOD threshold level is set with resistor combination R9/R11.

$$V_{CNF_IN} = \frac{R9}{R9 + R11} \cdot V_{DDP} \tag{3}$$

[Table 4](#) shows how FOD_T results from a certain V_{CNF_IN} voltage. In the table, V_{DDP} (the supply voltage) is assumed to be 5.0 V. However, levels are automatically compensated for deviations/changes in V_{DDP} .

Table 4. CNF3: FOD_T parameter

Input voltage on pin CNF_IN (CNF3 is active)	FOD_T level
$V_{CNF_IN} < 0.04\text{ V}$	FOD is disabled
$0.25\text{ V} < V_{CNF_IN} < 1.29\text{ V}$	$0.667 \times V_{CNF_IN}$ (W) ^[1]
$1.335\text{ V} < V_{CNF_IN} \leq V_{DDP}$	350 mW (default value)

[1] This equation assumes $V_{DDP} = 5\text{ V}$. The results are automatically adjusted to compensate for changes in the supply voltage level.

On the NXQ1TXH5DB1401 demo board resistor R8 is 47 kΩ, resistor R9 is 43 kΩ, and resistor R11 is 390 kΩ. The FOD_E is set to 280 mΩ and FOD_T is set to 330 mW.

For more information about FOD, see the NXQ1TXH5/101 data sheet ([Ref. 1](#)) and the application note ([Ref. 2](#)).

4.1.2.3 LED and buzzer modes (CNF4)

The LEDs (H1 and H2) implement a basic visual and audial user interface. An optional (AC) buzzer can be connected to X2. It is also allowed to eliminate one or both LEDs. However, if the product must be Qi certified, at least one LED is required. Not all LED modes lead to Qi certifiable applications.

Resistor combination R10/R11 sets the LED and buzzer behavior of the NXQ1TXH5/101 IC. The LED and buzzer modes are read by measuring the voltage on the CNF_IN pin while CNF4 is low.

$$V_{CNF_IN} = \frac{R10}{R10 + R11} \cdot V_{DDP} \tag{4}$$

Table 5 shows the LED and buzzer modes that result from a certain V_{CNF_IN} voltage. In the table, V_{DDP} (the supply voltage) is assumed to be 5.0 V. However, levels are automatically compensated for deviations/changes in V_{DDP} .

Table 5. LED and buzzer configuration set via the CNF_IN pin (when CNF4 is active)

Input voltage on the CNF_IN pin (when CNF4 is active)	R10 ^[1]	LED/buzzer mode
$V_{CNF_IN} < 0.04$ V	0 Ω ^[2]	1
0.085 V < $V_{CNF_IN} < 0.165$ V	10 k Ω	2
0.210 V < $V_{CNF_IN} < 0.290$ V	20.5 k Ω	3
0.335 V < $V_{CNF_IN} < 0.415$ V	32.4 k Ω	4
0.460 V < $V_{CNF_IN} < 0.540$ V	43.2 k Ω	5
0.585 V < $V_{CNF_IN} < 0.665$ V	56 k Ω	6
0.710 V < $V_{CNF_IN} < 0.790$ V	68.1 k Ω	7
0.835 V < $V_{CNF_IN} < 0.915$ V	82.5 k Ω	8
0.960 V < $V_{CNF_IN} < 1.040$ V	97.6 k Ω	9
1.085 V < $V_{CNF_IN} < 1.165$ V	113 k Ω	10
1.210 V < $V_{CNF_IN} < 1.290$ V	130 k Ω	11
1.335 V < $V_{CNF_IN} < V_{DDP}$ (V_{DDP} is maximum input level)	-	reserved

[1] Resistor R10 is connected in series with 390 k Ω resistor (R11) to V_{DDP} ; Different resistor values can be used provided the ratio between R10 and R11 is maintained; use 1 % tolerance. The resistance values are calculated assuming $V_{DDP} = 5$ V; to compensate for changes in the supply voltage level, the equation is automatically adjusted.

[2] Instead of a 0 Ω resistor, connect the CNF4 pin directly to CNF_IN.

On the NXQ1TXH5DB1401 demo board, resistor R10 is 130 k Ω and resistor R11 is 390 k Ω . These values make the IC operate in LED/buzzer mode 11. Furthermore, the red LED is configured to operate in inverted mode. Figure 3 shows the LED (blinking) pattern of the NXQ1TXH5DB1401 demo board in its default configuration. For more information on the other operating options, see the NXQ1TXH5/101 data sheet (Ref. 1) and the application note (Ref. 2).

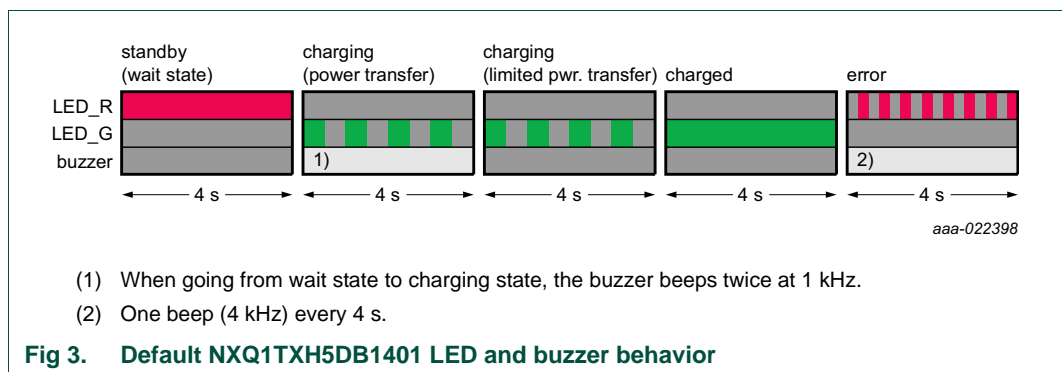

4.1.3 Indicators

The NXQ1TXH5DB1401 demo board incorporates 2 on-board LED indicators:

- Green LED:
User interface information - Power-on and error (see [Figure 3](#)).
- Red LED:
User interface information - Charging status (see [Figure 3](#)).

Optionally, a low cost AC piezo buzzer can be connected to X2 (TDK PS1240P02CT3 or equivalent). When the buzzer is connected, resistor R12 (1 k Ω) must be mounted as well. The buzzer behaves as shown in [Figure 3](#).

When the NXQ1TXH5DB1401 demo board is powered on, the red LED lights up immediately. Some moments later the green LED blinks 3 times while the red LED is dimmed simultaneously. This start-up blinking sequence indicates that the NXQ1TXH5/101 IC is now in wait state and ready to accept a wireless power receiver. If a wireless power receiver is already present at power-up, the start-up blinking sequence is skipped and the system enters the charging state immediately.

4.1.4 Thermal protection

In the NXQ1TXH5DB1401 demo board, thermal protection with an NTC thermistor is disabled by default. The temperature limiting power reduction mechanism, which is explained in the application note ([Ref. 2](#)), is also disabled by connecting the NTC pin of the NXQ1TXH5/101 IC to ground. It is done by mounting a 0 Ω jumper at the position of capacitor C13.

Removing the 0 Ω jumper from position C13 enables the temperature reduction mechanism.

5. Schematic

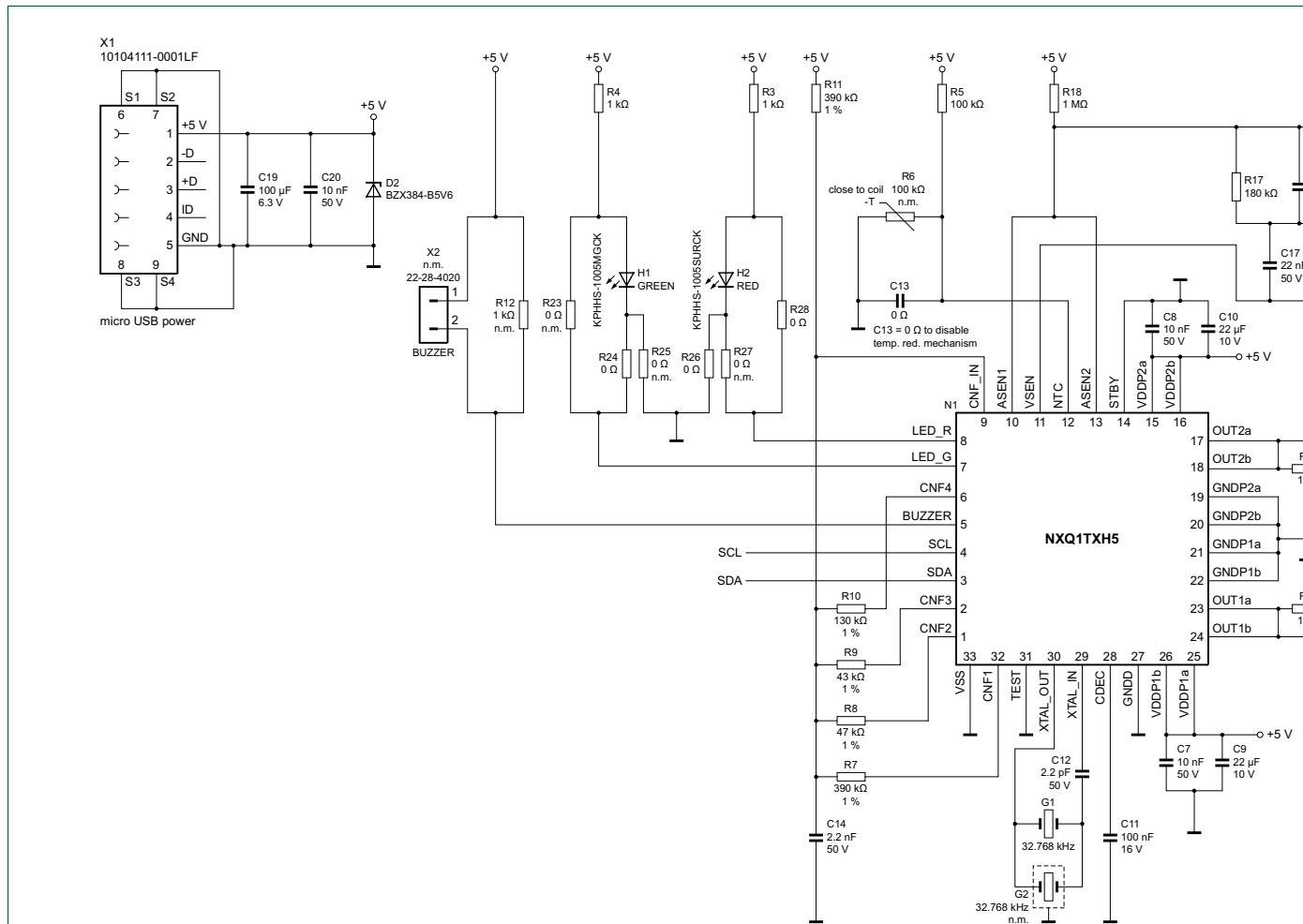

n.m. = not mounted

Fig 4. NXQ1TXH5DB1401 demo board schematic diagram

6. Bill Of Material (BOM)

Table 6. NXQ1TXH5DB1401 bill of materials

Reference	Description and values	Part number	Manufacturer
C1; C2	capacitor; 6.8 nF; 50 V; X7R; 0402	-	-
C3; C4	capacitor; 82 nF; 50 V; NP0; 1206	GRM31C5C1H823JA01L	Murata
C5; C6	capacitor; 100 nF; 50 V; NP0; 1206	CGA5L2C0G1H104J160AA	TDK
C7; C8	capacitor; 10 nF; 50 V; X7R; 0603	-	-
C9; C10	capacitor; 22 μ F; 10 V; X5R; 1206	GRM31CR61A226KE19L	Murata
C11	capacitor; 100 nF; 16 V; X7R; 0402	-	-
C12	capacitor; 2.2 pF; 50 V; NP0; 0402	-	-
C13	resistor; 0 Ω (jumper); 0603 ^[1]	-	-
C14	capacitor; 2.2 nF; 50 V; NP0; 0603	-	-
C15	capacitor; 10 nF; 25 V; NP0; 0603	-	-
C16	capacitor; 1 nF; 25 V; NP0; 0603	-	-
C17; C18	capacitor; 22 nF; 50 V; X7R; 0603	-	-
C19	capacitor; 100 μ F; 6.3 V; X5R; 1206	GRM31CR60J107ME39L	Murata
C20	capacitor; 10 nF; 50 V; X7R; 0805		
D1	diode; Schottky; 30 V; 200 mA	1PS76SB10	NXP Semiconductors
D2	diode; Zener; 5.6 V; 300 mW	BZX384-B5V6	NXP Semiconductors
G1	crystal; 32.768 kHz; SMT	S3215-03215-12-20-NA	Yoketant
G2	crystal; not mounted; 32.768 kHz	AB26TRQ-32.768kHz-T	Abracon
H1	LED (green); 0402	KPHHS-1005MGCK	Kingbright
H2	LED (red); 0402	KPHHS-1005SURCK	Kingbright
L1	transmission coil; 6.3 μ H ^[2]	Y31-60055F	E&E
N1	IC	NXQ1TXH5/101	NXP Semiconductors
R1; R2	resistor; 1 Ω ; 5 %; 0402	-	-
R3; R4	resistor; 1 k Ω ; 5 %; 0603	-	-
R5	resistor; 100 k Ω ; 5 %; 0603	-	-
R6	thermistor; NTC; not mounted; 100 k Ω ; 1 %; 4250 K	NXFT15WF104FA2B050	Murata
R7; R11	resistor; 390 k Ω ; 1 %; 0603	-	-
R8	resistor; 47 k Ω ; 1 %; 0603	-	-
R9	resistor; 43 k Ω ; 1 %; 0603	-	-
R10	resistor; 130 k Ω ; 1 %; 0805	-	-
R12	resistor; not mounted; 1 k Ω ; 5 %; 0603	-	-
R13	resistor; 1.8 k Ω ; 1 %; 0603	-	-
R14	resistor; 27 k Ω ; 1 %; 0603	-	-
R15; R16	resistor; 15 k Ω ; 5 %; 0603	-	-
R17	resistor; 180 k Ω ; 5 %; 0603	-	-
R18	resistor; 1 M Ω ; 5 %; 0603	-	-
R23; R25; R27	resistor; not mounted; 0 Ω (jumper); 0603	-	-

Table 6. NXQ1TXH5DB1401 bill of materials ...continued

Reference	Description and values	Part number	Manufacturer
R24; R26; R28	resistor; 0 Ω (jumper); 0603	-	-
X1	connector; micro USB PCB socket	10104111-0001LF	FCI
X2	connector; header; straight; not mounted; 1 \times 2-way; 2.54 mm	-	Molex

[1] Instead of a 100 nF capacitor, a 0 Ω jumper is mounted in this position (See [Section 4.1.4](#)).

[2] Not mounted on the small electronics PCB but glued to the carrier PCB.

7. Layout

The layout of an NXQ1TXH5/101 wireless power transmitter application is relatively critical from an electrical and a thermal point of view. The PCB layout of the NXQ1TXH5DB1401 demo board and the aspects that are essential for proper operation are briefly explained below. For more information, see the NXQ1TXH5/101 application note (Ref. 2).

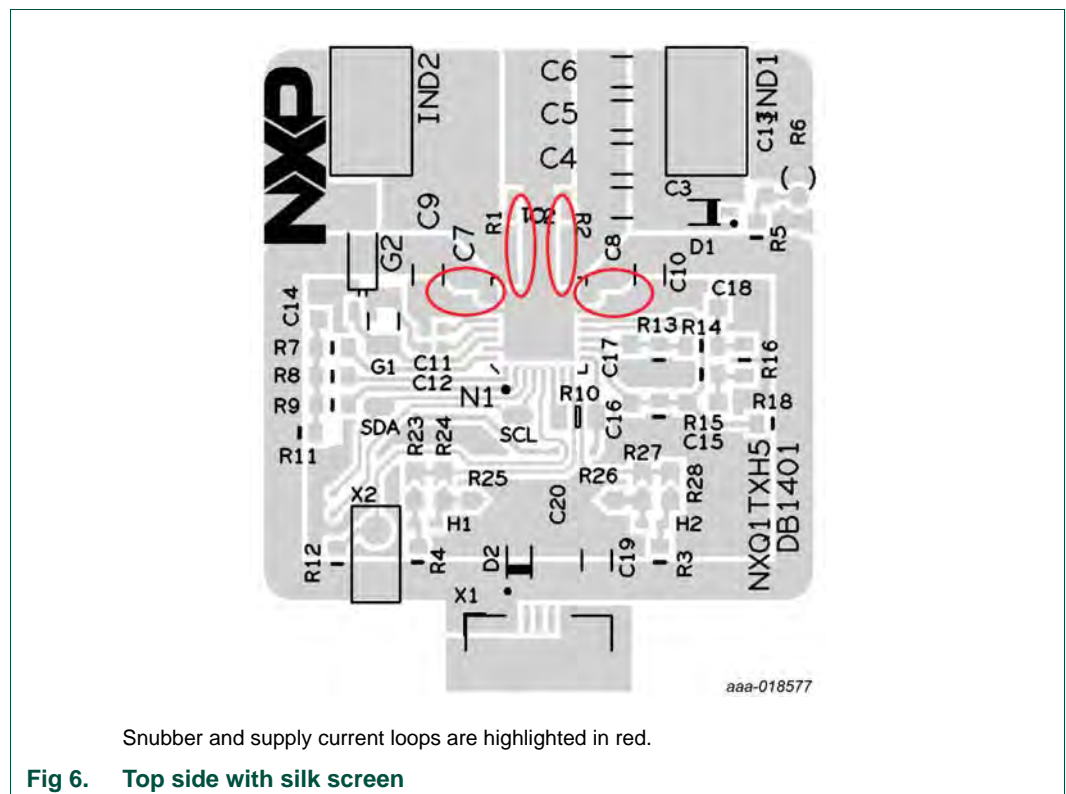
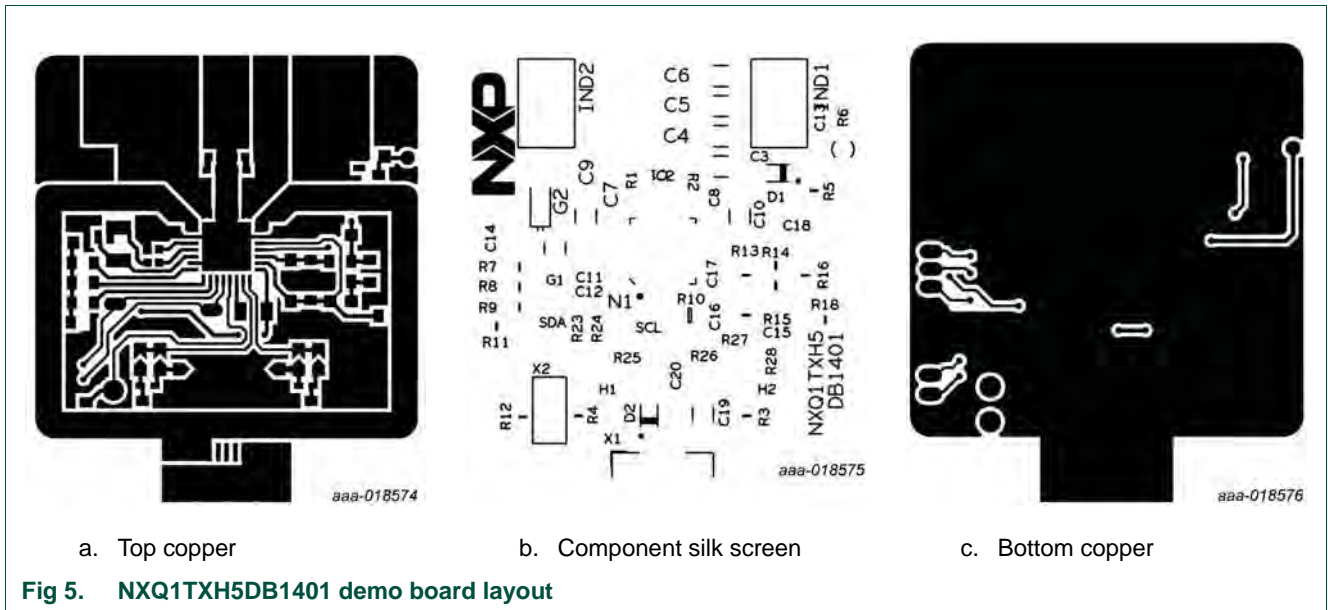

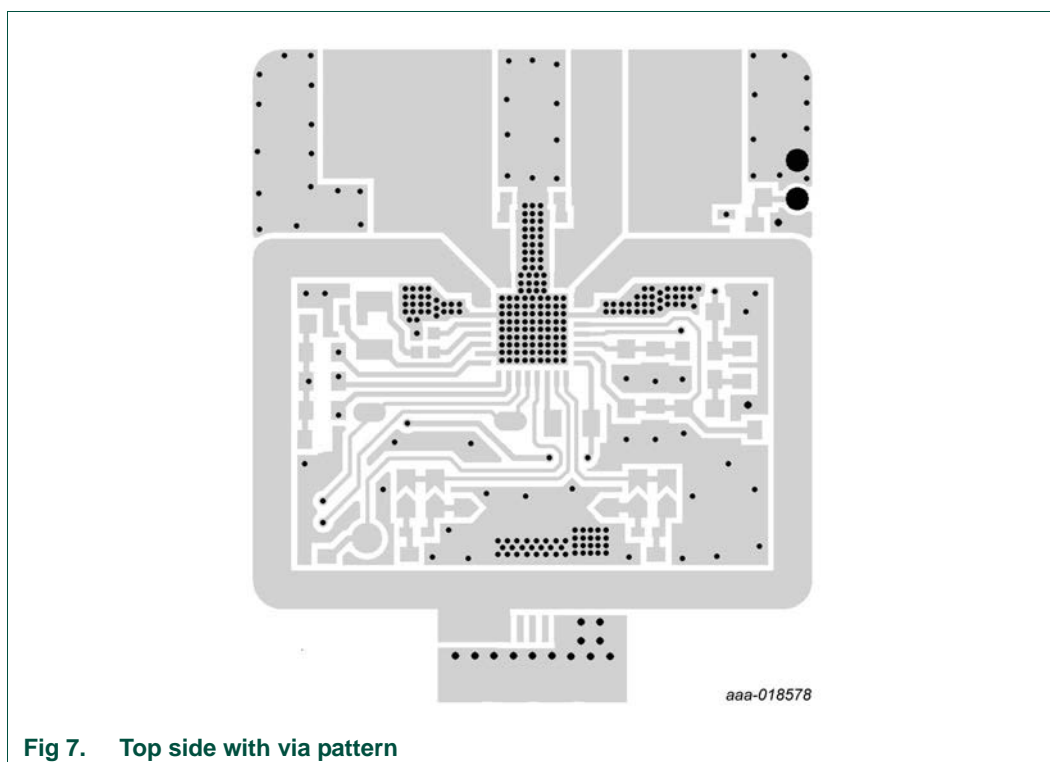

Fig 7. Top side with via pattern

7.1 Electrical layout aspects

- Snubber circuit capacitor C1 and resistor R1 and capacitor C2 and resistor R2 are mounted close to the output pins (pins 17 and 18; pins 23 and 24). The GND connections of the snubber circuits are close to IC GNDP pins 19, 20, 21, and 22. In this way, the two snubber loops (see [Figure 6](#)) are kept as small as possible.
- Decoupling capacitors C10 and C8 are placed very close to pins 15 and 16. They have a low-impedance connection to GND. The same applies to C9 and C7 which are very close to pins 25 and 26. In this way, the two supply loops (see [Figure 6](#)) are kept as small as possible.
- Shielding (non-current conducting) GND planes in the top copper layer are stitched to the non-current conducting GND areas of the bottom layer GND plane. The stitching is done with vias on the edges of the planes. The stitching can easily be recognized in [Figure 7](#).
- To prevent unnecessary power loss, VDD power traces to pins 15 and 16 and to pins 25 and 26 are wide low-impedance/low-loss traces.
- The output pins of the NXQ1TXH5/101 IC have very wide (low-impedance) traces to the LC-tank.
- Decoupling capacitor C11 is placed very close to pin 28 and it has a low-impedance connection to GND.
- To prevent overtones, the lengths of the traces leading to the crystal in series with the C12 capacitor are approximately 1 cm.

7.2 Thermal layout aspects

The full bridge switches and the sense resistor are integrated in the NXQ1TXH5/101, so all the dissipation is inside the chip. The PCB acts as a cooling plate, which makes the thermal layout aspects very important. Follow the guidelines below carefully.

- The exposed diepad of the NXQ1TXH5/101 must be soldered to the top layer of the board.
- Underneath the IC, NXQ1TXH5/101 a pattern of copper-filled thermal vias (see [Figure 7](#)) conducts heat from the top side to the bottom side of the PCB. The vias are resin-filled and copper capped for best thermal performance. Additional details about the NXQ1TXH5/101 footprint and thermal vias can be found in the application note ([Ref. 2](#)).
- Fill the bottom layer completely with copper. Do not place traces in the bottom layer. If traces in the bottom layer cannot be avoided, place them as far away from the NXQ1TXH5/101 as possible.
- The NXQ1TXH5/101 IC is placed more or less in the center of the PCB. In that way, the IC benefits most from its cooling circle.
- Use PCB material with a thickness of 0.8 mm. Thicker PCB material leads to longer vias. The result is a higher thermal resistance from the top layer to the bottom layer.
- To ensure a good heat conduction to the side of the board, the copper on the top and bottom layer has a thickness of 70 μm .
- To ensure good thermal conduction, the GND pins and the power conducting pins of the IC are attached to large copper areas.
- Many thermal vias surround the NXQ1TXH5/101 IC. The IC is the dominant dissipating component.
- The top and bottom layers of the PCB are covered with standard solder resist. Standard solder resist has a fairly good emissivity, which enhances thermal radiation. Uncovered and shiny areas on the PCB are kept to a minimum.

8. NXQ1TXH5DB1401 demo board performance

8.1 Efficiency

In the power transfer path from the USB receptacle input to the load/battery at the output of the Qi receiver power is lost due to conversion and transfer mechanisms. In [Figure 8](#), the typical efficiency of the NXQ1TXH5DB1401 demo board alone is shown in blue (1). The efficiency of the demo board is the fraction of input power that the NXQ1TXH5/101 application manages to convert into magnetic energy for transfer to the Qi receiver. Typically, this efficiency level is approximately 87 % at medium to high loads.

However, the system efficiency is more important to the end user. The system efficiency concerns the efficiency of the whole power chain from the USB input receptacle up to the load/battery. The typical system efficiency is shown in the gray curve (3) in [Figure 8](#). When the transmitter and receiver coils are aligned properly, the system efficiency is approximately 74 %.

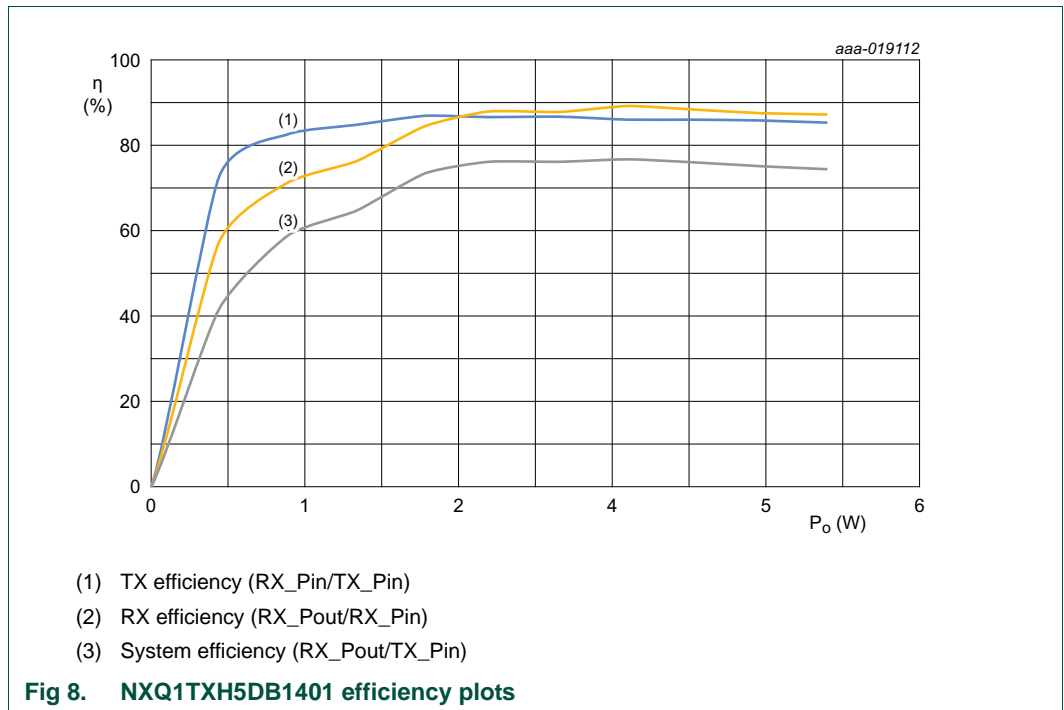

[Figure 9](#) shows the system efficiency plot for a Samsung Galaxy S5 back cover Qi receiver ([Ref. 3](#)) with the NXQ1TXH5DB1401 demo board. For this combination, the system efficiency is also approximately 74 % (typical).

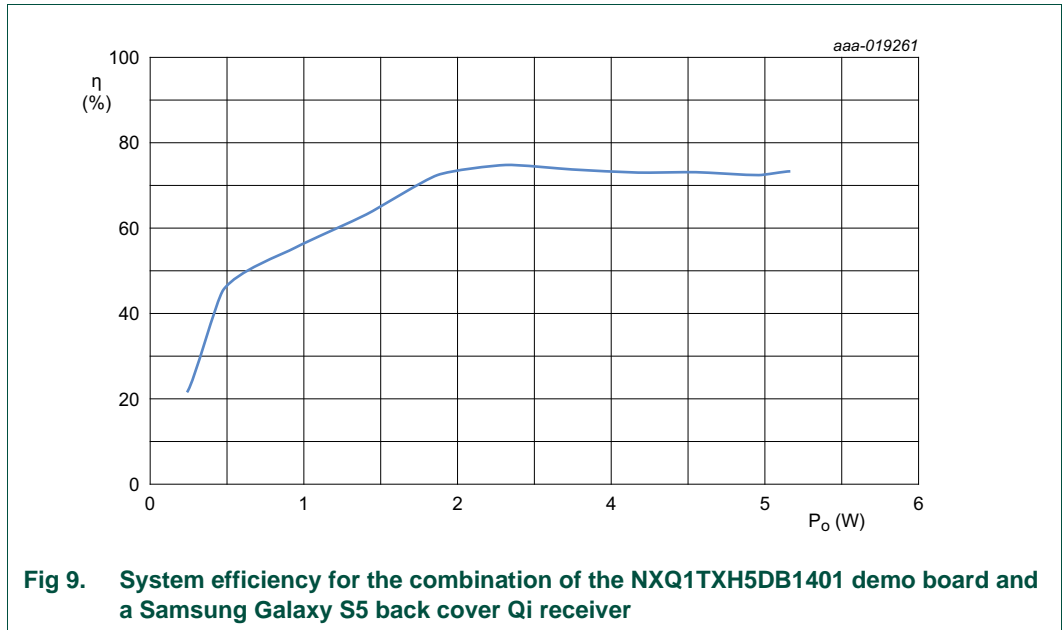

8.2 ElectroMagnetic Interference (EMI) performance

The NXQ1TXH5DB1401 demo board easily meets the CISPR22 (EN55022) requirements for both conducted and radiated emissions. All measurements were done at 5 W delivered to a load connected to the Samsung Galaxy S5 back cover Qi receiver (Ref. 3) under optimal alignment condition.

Figure 10 shows the conducted EMI spectrum for the NXQ1TXH5DB1401 demo board only. The 5 V supply to the board was from an EMI free linear power supply. Peak and average emissions have over 30 dB margin regarding the limits. Figure 11 shows the radiated EMI under the same conditions. For radiated EMI, the margin regarding the limit is typically 20 dB and at no-frequency less than 10 dB.

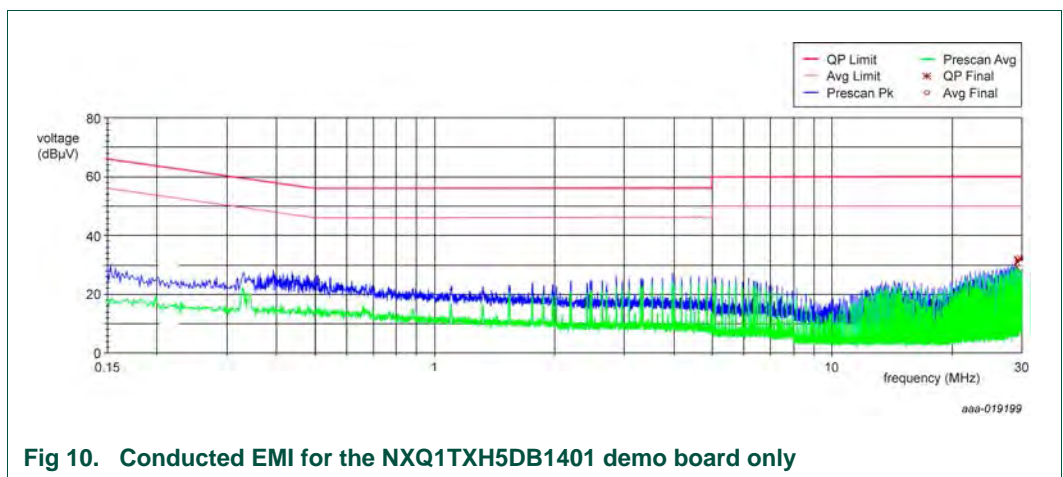

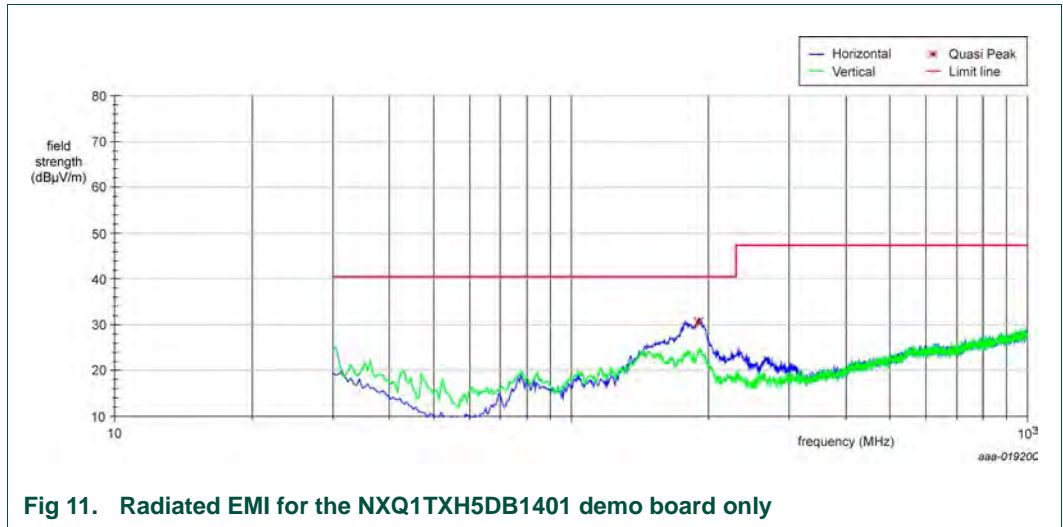

Fig 11. Radiated EMI for the NXQ1TXH5DB1401 demo board only

When connected to a regular switch-mode 5 V/2 A USB adapter, the adapter, not the NXQ1TXH5DB1401 demo board, causes most EMI emission. The NXQ1TXH5DB1401 demo board mainly contributes to the radiated EMI spectrum above 100 MHz. Most of the other noise can usually be attributed to the USB adapter.

Nevertheless, when the NXQ1TXH5DB1401 wireless power transfer application is used with a proper USB adapter, the setup easily meets the conducted and radiated EMI requirements according to CISPR22 (EN55022).

9. NXQ1TXH5DB1401 demo board options and modifications

Various alternative operating options can be realized on the NXQ1TXH5DB1401 demo board.

9.1 Smart Power Limiting (SPL) and Smart Power Reduction (SPR)

Alternative SPL and SPR levels can be realized by changing the value of resistor R7. For more information, see the application note ([Ref. 2](#)).

9.2 FOD

The NXQ1TXH5DB1401 demo board is delivered with the FOD threshold level (FOD_T) to 330 mW. The specific transmission coil that is connected to the board requires the FOD_E parameter to be set to 280 mΩ. When more or less power loss margin is required, resistor R9 can be modified according to [Table 4](#). When a different transmission coil is connected, FOD_E can be adapted according to [Table 3](#). Additional background information can be found in the application note ([Ref. 2](#)).

9.3 LEDs and buzzer

By default, the user interface is built with 2 LEDs. The green LED gives information about the operational status of the NXQ1TXH5DB1401 demo board. The red LED informs the user that the system is idle or in fault state.

9.3.1 Green LED

When no presentation of information about the operational status is required, the green LED can be eliminated. It can also be eliminated when operational information is combined with operational information by selecting a different LED/buzzer mode. In that case, resistor R4 can be eliminated as well.

Selecting another mode with resistor R10 (see [Table 5](#)) can change the behavior of the green LED. For more information, see the NXQ1TXH5/101 data sheet ([Ref. 1](#)) and the application note ([Ref. 2](#)). Not all LED modes lead to Qi certifiable applications.

By default, the green LED operates in 'normal' mode (jumper R24 mounted). If jumper R24 is removed and jumpers R23 and R25 are mounted, the LED operates in inverted mode.

The brightness level of the green LED can be changed by adapting the R4 resistor value. Do not select a value below 150 Ω because the dissipation level in the green LED can become too high.

9.3.2 Red LED

When no presentation of information about a fault condition or idle state is required, the red LED can be eliminated. It can also be eliminated when the fault condition information is combined with operational information by selecting a different LED/buzzer mode. When the red LED is eliminated, resistor R3 can be eliminated as well.

Selecting another mode with resistor R10 (see [Table 5](#)) can change the behavior of the red LED. For more information, see the NXQ1TXH5/101 data sheet ([Ref. 1](#)) and the application note ([Ref. 2](#)). Not all LED modes lead to Qi certifiable applications.

By default, the red LED operates in inverted mode (jumpers R26 and R28 mounted). If jumpers R26 and R28 are removed and jumper R27 is mounted, the LED operates in normal mode.

The brightness level of the red LED can be changed by adapting the R3 resistor value. Do not select a value below 150 Ω because the dissipation level in the red LED can become too high.

9.3.3 Buzzer

If, in addition to a visual presentation of information, an audial presentation information is required, a buzzer can be connected to the X2 connector. If a buzzer is connected, resistor R12 must be mounted as well. Use an AC Piezo type buzzer.

The behavior of the buzzer depends on the selected mode. For more information, see the NXQ1TXH5/101 data sheet (Ref. 1) and the application note (Ref. 2).

9.4 NTC and thermal behavior

An NTC thermistor can be connected to the NXQ1TXH5DB1401 demo board. The sensor is primarily intended to measure the temperature of the transmitter coil.

If monitoring the transmitter coil temperature and reacting to it accordingly is required, a wired thermistor must be connected to the R6 wire holes. Additionally, the 0 Ω jumper on the C13 position must be removed and a 100 nF capacitor must be mounted instead. Depending on the requirement, changing the value of resistor R5 may be required. For more information, see the application note (Ref. 2). Table 7 shows some common thermal protection implementation options.

Table 7. Trip and resume temperature examples and associated component values

T _{trip}	T _{resume}	R5	R6
60 °C	50 °C	115 kΩ	100 kΩ; β = 4330 K
65 °C	55 °C	95.3 kΩ	100 kΩ; β = 4330 K
70 °C	60 °C	76.8 kΩ	100 kΩ; β = 4330 K
75 °C	65 °C	90.9 kΩ	150 kΩ; β = 4500 K
80 °C	70 °C	75 kΩ	150 kΩ; β = 4500 K
85 °C	75 °C	62 kΩ	150 kΩ; β = 4500 K

10. Abbreviations

Table 8. Abbreviations

Acronym	Description
ASK	Amplitude Shift Keying
EMI	ElectroMagnetic Interference
FOD	Foreign Object Detection
LED	Light-Emitting Diode
NTC	Negative Temperature Coefficient
PCB	Printed-Circuit Board
PID	Proportional-Integral Derivative
SPL	Smart Power Limiting
SPR	Static Power Reduction
USB	Universal Serial Bus
WPC	Wireless Power Consortium

11. References

- [1] **NXQ1TXH5/101 data sheet** — One-chip 5 V Qi wireless transmitter; 2016, NXP Semiconductors
- [2] **AN11775 application note** — NXQ1TXH5/101 one-chip 5 V Qi wireless transmitter; 2016, NXP Semiconductors
- [3] **Samsung wireless charging cover** — Model EP-CG900IBE

12. Legal information

12.1 Definitions

Draft — The document is a draft version only. The content is still under internal review and subject to formal approval, which may result in modifications or additions. NXP Semiconductors does not give any representations or warranties as to the accuracy or completeness of information included herein and shall have no liability for the consequences of use of such information.

12.2 Disclaimers

Limited warranty and liability — Information in this document is believed to be accurate and reliable. However, NXP Semiconductors does not give any representations or warranties, expressed or implied, as to the accuracy or completeness of such information and shall have no liability for the consequences of use of such information. NXP Semiconductors takes no responsibility for the content in this document if provided by an information source outside of NXP Semiconductors.

In no event shall NXP Semiconductors be liable for any indirect, incidental, punitive, special or consequential damages (including - without limitation - lost profits, lost savings, business interruption, costs related to the removal or replacement of any products or rework charges) whether or not such damages are based on tort (including negligence), warranty, breach of contract or any other legal theory.

Notwithstanding any damages that customer might incur for any reason whatsoever, NXP Semiconductors' aggregate and cumulative liability towards customer for the products described herein shall be limited in accordance with the *Terms and conditions of commercial sale* of NXP Semiconductors.

Right to make changes — NXP Semiconductors reserves the right to make changes to information published in this document, including without limitation specifications and product descriptions, at any time and without notice. This document supersedes and replaces all information supplied prior to the publication hereof.

Suitability for use — NXP Semiconductors products are not designed, authorized or warranted to be suitable for use in life support, life-critical or safety-critical systems or equipment, nor in applications where failure or malfunction of an NXP Semiconductors product can reasonably be expected to result in personal injury, death or severe property or environmental damage. NXP Semiconductors and its suppliers accept no liability for inclusion and/or use of NXP Semiconductors products in such equipment or applications and therefore such inclusion and/or use is at the customer's own risk.

Applications — Applications that are described herein for any of these products are for illustrative purposes only. NXP Semiconductors makes no representation or warranty that such applications will be suitable for the specified use without further testing or modification.

Customers are responsible for the design and operation of their applications and products using NXP Semiconductors products, and NXP Semiconductors accepts no liability for any assistance with applications or customer product design. It is customer's sole responsibility to determine whether the NXP Semiconductors product is suitable and fit for the customer's applications and products planned, as well as for the planned application and use of customer's third party customer(s). Customers should provide appropriate design and operating safeguards to minimize the risks associated with their applications and products.

NXP Semiconductors does not accept any liability related to any default, damage, costs or problem which is based on any weakness or default in the customer's applications or products, or the application or use by customer's third party customer(s). Customer is responsible for doing all necessary testing for the customer's applications and products using NXP Semiconductors products in order to avoid a default of the applications and the products or of the application or use by customer's third party customer(s). NXP does not accept any liability in this respect.

Export control — This document as well as the item(s) described herein may be subject to export control regulations. Export might require a prior authorization from competent authorities.

Evaluation products — This product is provided on an "as is" and "with all faults" basis for evaluation purposes only. NXP Semiconductors, its affiliates and their suppliers expressly disclaim all warranties, whether express, implied or statutory, including but not limited to the implied warranties of non-infringement, merchantability and fitness for a particular purpose. The entire risk as to the quality, or arising out of the use or performance, of this product remains with customer.

In no event shall NXP Semiconductors, its affiliates or their suppliers be liable to customer for any special, indirect, consequential, punitive or incidental damages (including without limitation damages for loss of business, business interruption, loss of use, loss of data or information, and the like) arising out of the use of or inability to use the product, whether or not based on tort (including negligence), strict liability, breach of contract, breach of warranty or any other theory, even if advised of the possibility of such damages.

Notwithstanding any damages that customer might incur for any reason whatsoever (including without limitation, all damages referenced above and all direct or general damages), the entire liability of NXP Semiconductors, its affiliates and their suppliers and customer's exclusive remedy for all of the foregoing shall be limited to actual damages incurred by customer based on reasonable reliance up to the greater of the amount actually paid by customer for the product or five dollars (US\$5.00). The foregoing limitations, exclusions and disclaimers shall apply to the maximum extent permitted by applicable law, even if any remedy fails of its essential purpose.

Safety of high-voltage evaluation products — The non-insulated high voltages that are present when operating this product, constitute a risk of electric shock, personal injury, death and/or ignition of fire. This product is intended for evaluation purposes only. It shall be operated in a designated test area by personnel that is qualified according to local requirements and labor laws to work with non-insulated mains voltages and high-voltage circuits.

The product does not comply with IEC 60950 based national or regional safety standards. NXP Semiconductors does not accept any liability for damages incurred due to inappropriate use of this product or related to non-insulated high voltages. Any use of this product is at customer's own risk and liability. The customer shall fully indemnify and hold harmless NXP Semiconductors from any liability, damages and claims resulting from the use of the product.

Translations — A non-English (translated) version of a document is for reference only. The English version shall prevail in case of any discrepancy between the translated and English versions.

12.3 Trademarks

Notice: All referenced brands, product names, service names and trademarks are the property of their respective owners.

GreenChip — is a trademark of NXP B.V.

13. Contents

1	Introduction	3
1.1	NXQ1TXH5/101 features	3
1.2	NXQ1TXH5DB1401 demo board features	4
1.3	NXQ1TXH5/101 application information.....	4
2	Specifications	5
3	Board photograph	5
4	Functional description	6
4.1	Setup and operation of the NXQ1TXH5DB1401 demo board	6
4.1.1	NXQ1TXH5DB1401 demo board connections .	6
4.1.2	Configuration	7
4.1.2.1	Smart Power Limiting (SPL) and Smart Power Reduction (SPR) (pin CNF1)	7
4.1.2.2	FOD (pins CNF2 and CNF3)	7
4.1.2.3	LED and buzzer modes (CNF4)	8
4.1.3	Indicators	10
4.1.4	Thermal protection	10
5	Schematic	11
6	Bill Of Material (BOM)	12
7	Layout	14
7.1	Electrical layout aspects	15
7.2	Thermal layout aspects.....	16
8	NXQ1TXH5DB1401 demo board performance	17
8.1	Efficiency	17
8.2	ElectroMagnetic Interference (EMI) performance	18
9	NXQ1TXH5DB1401 demo board options and modifications	20
9.1	Smart Power Limiting (SPL) and Smart Power Reduction (SPR).....	20
9.2	FOD	20
9.3	LEDs and buzzer	20
9.3.1	Green LED	20
9.3.2	Red LED	20
9.3.3	Buzzer	21
9.4	NTC and thermal behavior	21
10	Abbreviations	22
11	References	22
12	Legal information	23
12.1	Definitions	23
12.2	Disclaimers	23
12.3	Trademarks.....	23
13	Contents	24

Please be aware that important notices concerning this document and the product(s) described herein, have been included in section 'Legal information'.

© NXP Semiconductors N.V. 2016. All rights reserved.

For more information, please visit: <http://www.nxp.com>
For sales office addresses, please send an email to: salesaddresses@nxp.com

Date of release: 13 April 2016
Document identifier: UM10943

X-ON Electronics

Largest Supplier of Electrical and Electronic Components

Click to view similar products for [Power Management IC Development Tools](#) category:

Click to view products by [NXP](#) manufacturer:

Other Similar products are found below :

[EVAL6482H-DISC](#) [EVAL-AD5522EBUZ](#) [EVAL-ADM1060EBZ](#) [EVAL-ADM1073MEBZ](#) [EVAL-ADM1166TQEBZ](#) [EVAL-ADM1168LQEBZ](#) [EVAL-ADM1171EBZ](#) [EVAL-ADM1276EBZ](#) [EVB-EN5319QI](#) [EVB-EN5365QI](#) [EVB-EN6347QI](#) [EVB-EP5348UI](#) [MIC23158YML EV](#) [MIC23451-AAAYFL EV](#) [MIC5281YMME EV](#) [124352-HMC860LP3E](#) [ADM00513](#) [ADM8611-EVALZ](#) [ADM8612-EVALZ](#) [ADM8613-EVALZ](#) [ADM8615-EVALZ](#) [ADP1046ADC1-EVALZ](#) [ADP1055-EVALZ](#) [ADP122-3.3-EVALZ](#) [ADP130-0.8-EVALZ](#) [ADP130-1.2-EVALZ](#) [ADP130-1.5-EVALZ](#) [ADP130-1.8-EVALZ](#) [ADP160UJZ-REDYKIT](#) [ADP166UJ-EVALZ](#) [ADP1712-3.3-EVALZ](#) [ADP1714-3.3-EVALZ](#) [ADP1715-3.3-EVALZ](#) [ADP1716-2.5-EVALZ](#) [ADP1740-1.5-EVALZ](#) [ADP1752-1.5-EVALZ](#) [ADP1754-1.5-EVALZ](#) [ADP1828LC-EVALZ](#) [ADP1870-0.3-EVALZ](#) [ADP1871-0.6-EVALZ](#) [ADP1873-0.6-EVALZ](#) [ADP1874-0.3-EVALZ](#) [ADP1876-EVALZ](#) [ADP1879-1.0-EVALZ](#) [ADP1882-1.0-EVALZ](#) [ADP1883-0.6-EVALZ](#) [ADP197CB-EVALZ](#) [ADP199CB-EVALZ](#) [ADP2102-1.25-EVALZ](#) [ADP2102-1.2-EVALZ](#)