

Surface Mount Common Mode Choke

NCC Series

FEATURES

- HIGH COMMON MODE IMPEDANCE AT HIGH FREQUENCY
- LOW PROFILE SURFACE MOUNT PACKAGE
- SHIELDED PROVIDING EXCELLENT NOISE SUPPRESSION
- SUITABLE FOR HIGH SPEED DIGITAL EQUIPMENT (USB/IEEE)
- Pb-FREE CONSTRUCTION
- BOTH FLOW AND REFLOW SOLDERING APPLICABLE

**RoHS
Compliant**

includes all homogeneous materials

*See Part Number System for Details

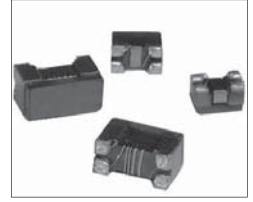

CHARACTERISTICS

Case Size	0805	1206
Impedance Range	30~ 370 Ohms	30 ~ 2,200 Ohms
Available Tolerance	±25%	
Temperature Range	-40°C ~ +125°C	
Withstanding voltage	125VDC 30 seconds	
Insulation Resistance	10MΩ after application 50V for 30 seconds	
Resistance to Solder Heat	260°C ±5°C for 10 seconds	
Temperature Cycling	±25% of initial value after 10 cycles (-40°C/+20°C/+125°C/+20°C)	

PART NUMBER SYSTEM

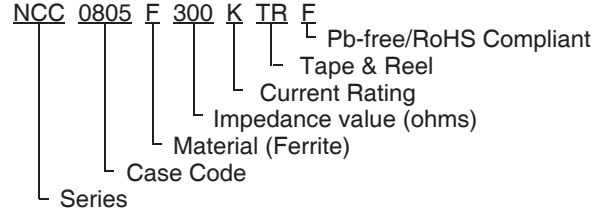

NCC0805 SPECIFICATIONS

NIC Part Number	Impedance (Ω)	Test Frequency (MHz)	DC Resistance (Ω max.)	DC Current (mA max.)	Voltage Rating (Vdc)	Withstanding Voltage (Vdc)	Insulation Resistance (Ω)
NCC0805F300KTRF	30 ±25%	100	0.2	400	50	125	10Meg
NCC0805F670KTRF	67 ±25%		0.25	400			
NCC0805F900KTRF	90 ±25%		0.3	400			
NCC0805F121KTRF	120 ±25%		0.3	400			
NCC0805F161JTRF	160 ±25%		0.35	350			
NCC0805F181JTRF	180 ±25%		0.35	350			
NCC0805F221HTRF	220 ±25%		0.4	300			
NCC0805F221MTRF	220 ±25%		0.4	600			
NCC0805F261HTRF	260 ±25%		0.4	300			
NCC0805F301HTRF	300 ±25%		0.45	300			
NCC0805F361FTRF	360 ±25%		0.5	100			
NCC0805F371FTRF	370 ±25%		0.5	100			

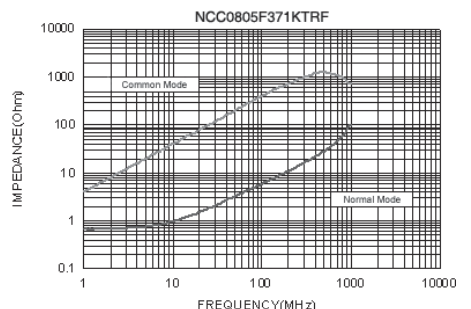
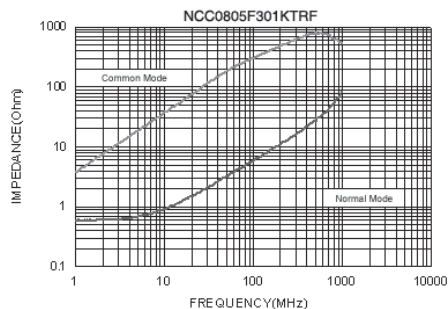
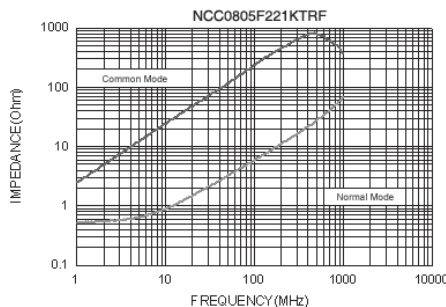
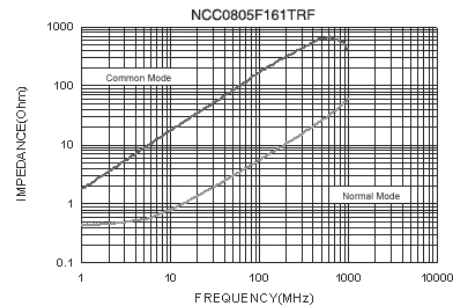
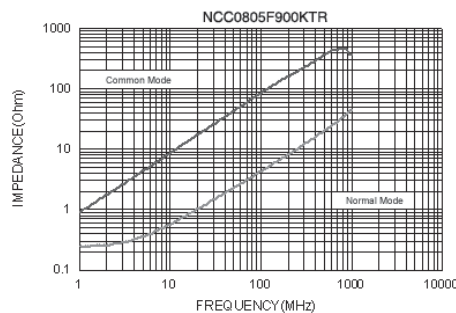
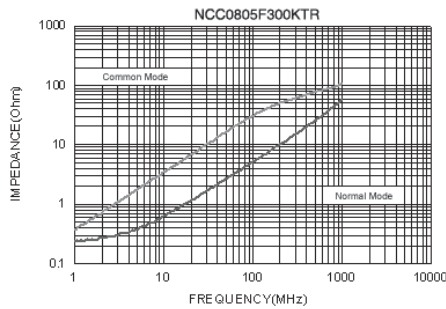

NCC1206 SPECIFICATIONS

NIC Part Number	Impedance (Ω)	Test Frequency (MHz)	DC Resistance (Ω max.)	DC Current (mA max.)	Voltage Rating (Vdc)	Withstanding Voltage (Vdc)	Insulation Resistance (Ω)
NCC1206F300KTRF	30 \pm 25%	100	0.2	400	50	125	10Meg
NCC1206F670KTRF	67 \pm 25%		0.3	400			
NCC1206F800KTRF	80 \pm 25%		0.3	400			
NCC1206F900KTRF	90 \pm 25%		0.3	400			
NCC1206F121KTRF	120 \pm 25%		0.3	400			
NCC1206F161JTRF	160 \pm 25%		0.35	350			
NCC1206F181JTRF	180 \pm 25%		0.35	350			
NCC1206F221HTRF	220 \pm 25%		0.45	300			
NCC1206F261HTRF	260 \pm 25%		0.45	300			
NCC1206F281HTRF	280 \pm 25%		0.45	300			
NCC1206F301HTRF	300 \pm 25%		0.5	300			
NCC1206F361HTRF	360 \pm 25%		0.6	300			
NCC1206F431HTRF	430 \pm 25%		0.6	300			
NCC1206F471HTRF	470 \pm 25%		0.7	300			
NCC1206F551HTRF	550 \pm 25%		0.75	300			
NCC1206F601HTRF	600 \pm 25%		0.8	300			
NCC1206F222GTRF	2200 \pm 25%		1.2	200			

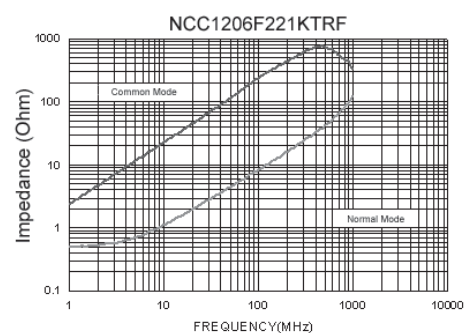
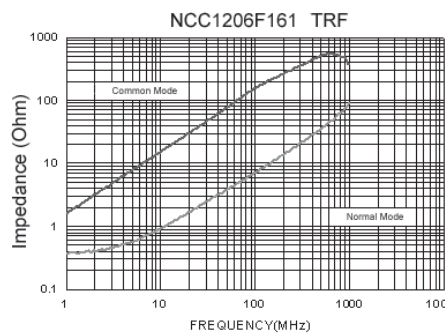
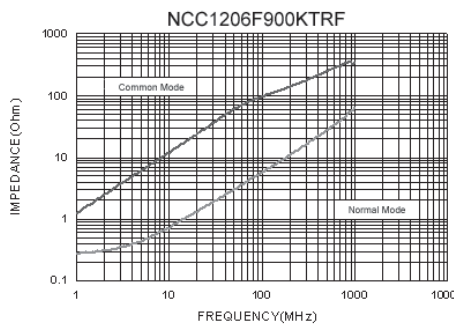

CASE DIMENSIONS (mm)

Type	A \pm 0.2	B \pm 0.2	C \pm 0.2	D1 \pm 0.1	D2 \pm 0.1	E \pm 0.1
NCC0805	2.0	1.2	1.2	0.55	0.46	0.15
NCC1206	3.2	1.6	2.0	0.50	0.50	0.15

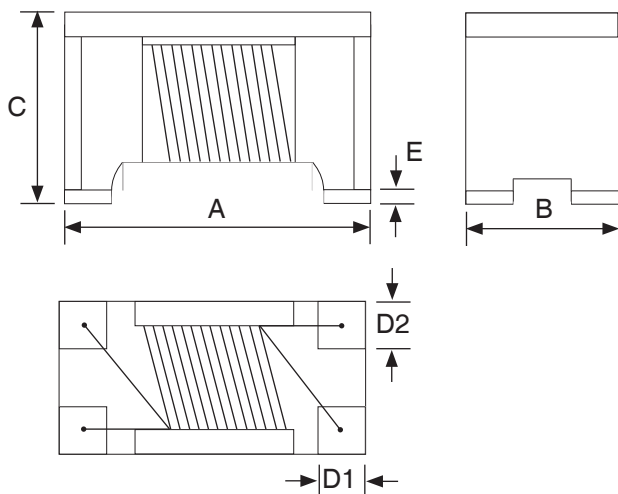

CIRCUIT SCHEMATIC

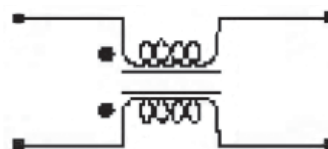

LAND PATTERN DIMENSIONS (mm)

Case Size	L	W	T1	T2
0805	2.60	1.25	1.10	0.45
1206	3.70	1.60	1.90	0.40

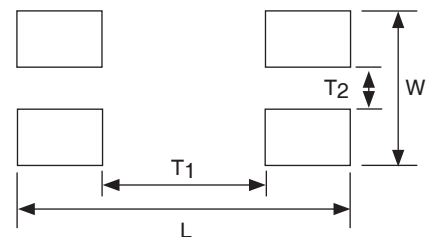

RECOMMENDED REFLOW SOLDERING PROFILE

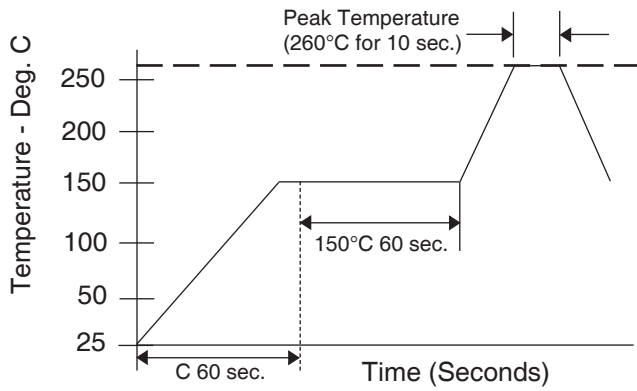

RECOMMENDED FLOW SOLDERING PROFILE

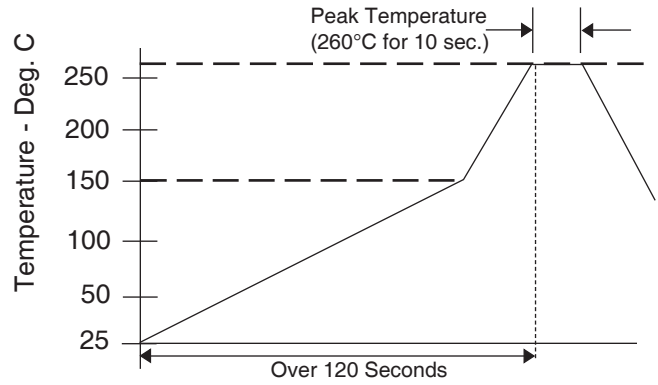

Series	A ± 0.1	B ± 0.1	E ± 0.1	F ± 0.05	P ₀ ± 0.1	P ₁ ± 0.1	D ₁ ± 0.1	W ± 0.1	t ₁ ± 0.05	t ₂ ± 0.1	Reel Quantity
NCC0805	1.50	2.35	1.75	3.5	4.0	4.0	1.5	8.0	0.22	1.45	2,000
NCC1206	1.88	3.50								2.10	

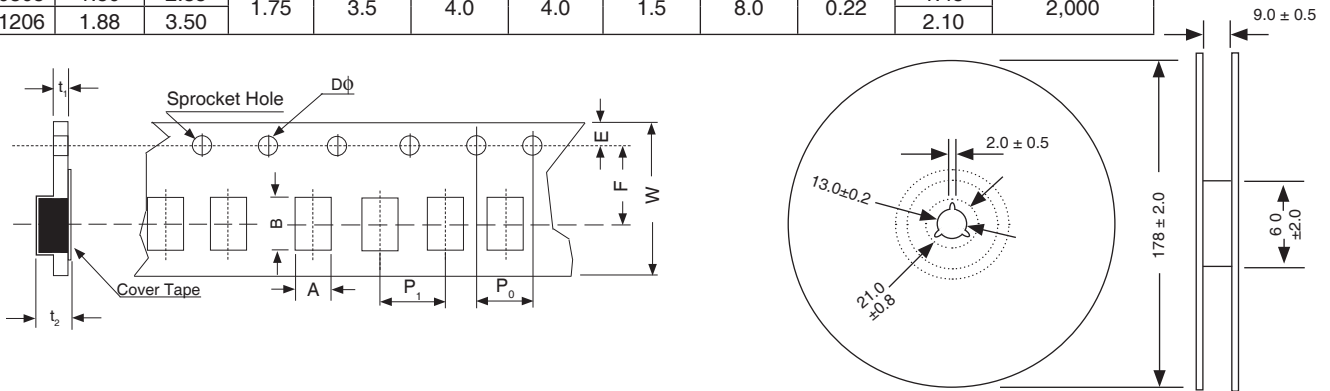

REEL QUANTITY: 2,000 per reel
(0805 & 1206 case size)

X-ON Electronics

Largest Supplier of Electrical and Electronic Components

Click to view similar products for [Gate Drivers](#) category:

Click to view products by [NIC](#) manufacturer:

Other Similar products are found below :

[00028](#) [00053P0231](#) [8967380000](#) [56956](#) [CR7E-30DB-3.96E\(72\)](#) [57.404.7355.5](#) [LT4936](#) [57.904.0755.0](#) [5801-0903](#) [5803-0901](#) [5811-0902](#)
[5813-0901](#) [58410](#) [00576P0030](#) [00581P0070](#) [5882900001](#) [00103P0020](#) [00600P0005](#) [00-9050-LRPP](#) [00-9090-RDPP](#) [5951900000](#) [01-](#)
[1003W-10/32-15](#) [LTI LA6E-1S-WH-RC-FN12VXCR1](#) [0131700000](#) [00-2240](#) [LTP70N06](#) [LVP640](#) [0158-624-00](#) [5J0-1000LG-SIL](#) [020017-13](#)
[LY1D-2-5S-AC120](#) [LY2-0-US-AC120](#) [LY2-US-AC240](#) [LY3-UA-DC24](#) [00-5150](#) [00576P0020](#) [00600P0010](#) [LZNQ2M-US-DC5](#) [LZNQ2-](#)
[US-DC12](#) [LZP40N10](#) [00-8196-RDPP](#) [00-8274-RDPP](#) [00-8275-RDNP](#) [00-8609-RDPP](#) [00-8722-RDPP](#) [00-8728-WHPP](#) [00-8869-RDPP](#) [00-](#)
[9051-RDPP](#) [00-9091-LRPP](#) [00-9291-RDPP](#)