

ErgoN'

Amphenol Ergonomic Industrial Connectors



Applications :

- Electric Cars Batteries
- Electric Trucks & Buses
- Power plants :
 - * Traditionnal
 - * Windmills
 - * Solar farms
- Heavy Equipment

Description

Because you can assemble and connect our connectors daily, Amphenol has designed this new range taking into account **Ergonomics**. As a result, this new range is very easy to assemble and to connect with a patented push-lock mechanism.

High Power applications require specific features in connectors design. For example, the development of fleet of rental **Electric Vehicles** which run exclusively on rechargeable/replaceable batteries generates significant new demands on connectors.

Common requirements on these battery connectors have been identified :

- High current capabilities
- Safe for the user and the electronics
- Easy to assemble and connect
- Robust & sealed
- High mating cycles

Our new ErgoN' series has been designed following these requirements.

Up to 350 A current (Radsok Technology)

Interlock contacts, already shunted & assembled in factory

IP2X unmated & IP68 mated

Easy and secure Push & Lock Mating mechanism

Mechanical coding molded on shells (keys)







Possibility to have male or female insert on each shell

3 colours available (Red, Black, Blue)

High mating cycles (3000) and low insertion forces (Railway proven technology)

Possibility to have a double locking (optional)

Shells and Inserts P/N

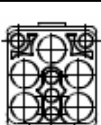
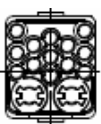
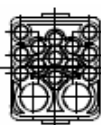
		Description	Part Number
Receptacle Shell		Receptacle Black, B coding	Ergon LR BK
		Receptacle Red, A coding	Ergon LR RD
		Receptacle Blue, A coding	Ergon LR BU
Cap for Receptacle		Rubber Cap for Receptacle	Ergon LR CAP
Plug Shell		Plug Black, B coding	Ergon LP BK
		Plug Red, A coding	Ergon LP RD
		Plug Blue, A coding	Ergon LP BU
Plug Shell Large section		Plug Large section Black, B coding	Ergon LLP BK
		Plug Large section Red, A coding	Ergon LLP RD
Inserts		PW1 insert 1xD10mm female contact cavity 2x D1,5mm female contacts cavities Operating voltage : up to 2500VAC	Ergon LI PW1 S
		PW1 Insert 1xD10mm male contact cavity 2x interlock male contacts shunted Operating voltage : up to 2500VAC	Ergon LI PW1 P
		PW2 Insert 5xD3,5mm female contacts cavities 3xD1,5mm male contacts cavities 2x D1,5mm female contacts cavities Operating voltage : up to 750VAC	Ergon LI PW2 S
		PW2 Insert 5xD3,5mm male contacts cavities 3xD1,5mm female contacts cavities 2x interlock male contacts shunted Operating voltage : up to 750VAC	Ergon LI PW2 P
		BMS Insert (<i>Battery Mgt System</i>) 2x D3,5mm female contacts cavities 13x D1,5mm female cavities Operating voltage : up to 1200VAC	Ergon LI BMS S
		BMS Insert (<i>Battery Mgt System</i>) 2x D3,5mm male contacts cavities 11x D1,5mm male cavities 2x interlock male contacts shunted Operating voltage : up to 1200VAC	Ergon LI BMS P

* Shielding solution on request

Contacts P/N

	Description	Cable section	P/N
D10mm Contacts (Radsok Technology)	Male IP2X (350A) contact	Cable section 50mm ²	30 003
	Male IP2X (350A) contact	Cable section 70mm ²	30 051
	Male IP2X (350A) contact	Cable section 120mm ²	30 138
	Male IP2X (350A) contact	Male contact for lug <i>(to be used only with receptacle)</i>	30 142
	Female IP2X (350A)	Cable section 50mm ²	30 006
	Female IP2X (350A) contact	Cable section 70mm ²	30 052
	Female IP2X (350A) contact	Cable section 120mm ²	30 118
	Female IP2X (350A) contact	Female contact for lug <i>(to be used only with receptacle)</i>	30 140
D3,5mm Contacts	Male IP2X (60A) contact	Cable section 4 to 10mm ²	30 018
	Male (60A) contact	Cable section 4 to 10mm ²	30 046
	Female (60A) contact	Cable section 4 to 10mm ²	30 071
	Reducer	Cable section 2,5mm ²	30 112GO
D1,5mm Contacts	Male signal contact (8A)	Cable section 0,34 to 1,5mm ²	30 526
	Female signal contact (8A)	Cable section 0,34 to 1,5mm ²	30 521

Tooling

	Description	Part Number
Crimping tool for D10mm contact	Manual hydraulic Plier	177-809947-00 or Dubuis D31
	Electric Plier	Dubuis D31 ELEC
	Dies 50mm ²	177-030033-00 or Dubuis 77464
Crimping tool for D3,5mm contact	Plier 60 A	177-030246-00 or COJACK TGV 515 or OCETA M 317
	Locator 60 A	177-030248-00 or COJACK TGV 503 or OCETA TP 805
Crimping tool for D1,5mm contact	Plier 8 A	177-030245-00 or COJACK TGV 101 or OCETA FT.8
	Locator 8 A	177-030247-00 or COJACK TGV 202 or OCETA SH 463
Insertion & extraction tools for D10mm	Insertion 350 A	No tool, by hand
	Extraction 350 A	177-030029-91
Insertion & extraction tools for D3,5mm	Insertion 60 A	177-030038-00
	Extraction 60 A	177-030037-00
Insertion & extraction tools for D1,5mm	Insertion 8 A	177-030035-00
	Extraction 8 A	177-030036-00
Extraction tools - Inserts	Inserts insertion	No tool, by hand
	Inserts extraction	177-030034-91

Key Characteristics

Environnement :

Sealing : IP68 per EN 60529 (CEI 529)
 User safety : IP2X per EN 60529 (CEI 529)
 Flame resistance : UL 94 V0
 Thermal shock : 5 cycles of 2 h -40°C / +85°C
 Operating Temperature : - 30°C / +85°C

Mechanical :

3000 mating / unmating cycles
 Vibrations : per ISO 16750 Road vehicles. Environmental conditions and testing for electrical and electronic equipment

Current & Temperature rise (*)

For insert PW1
 Max temp. rise @ 350 A : 25°C
 Max temp. rise @ 500 A : 50°C (5s peak)
 (*) with cable section 50 mm²

Custom current profile can be analysed, consult us.

Material

Connector shells : Thermoplastic
 Contacts : machined Brass Alloy
 Orings : Silicone & Neoprene
 Panel gasket : Silicone

Overall dimensions

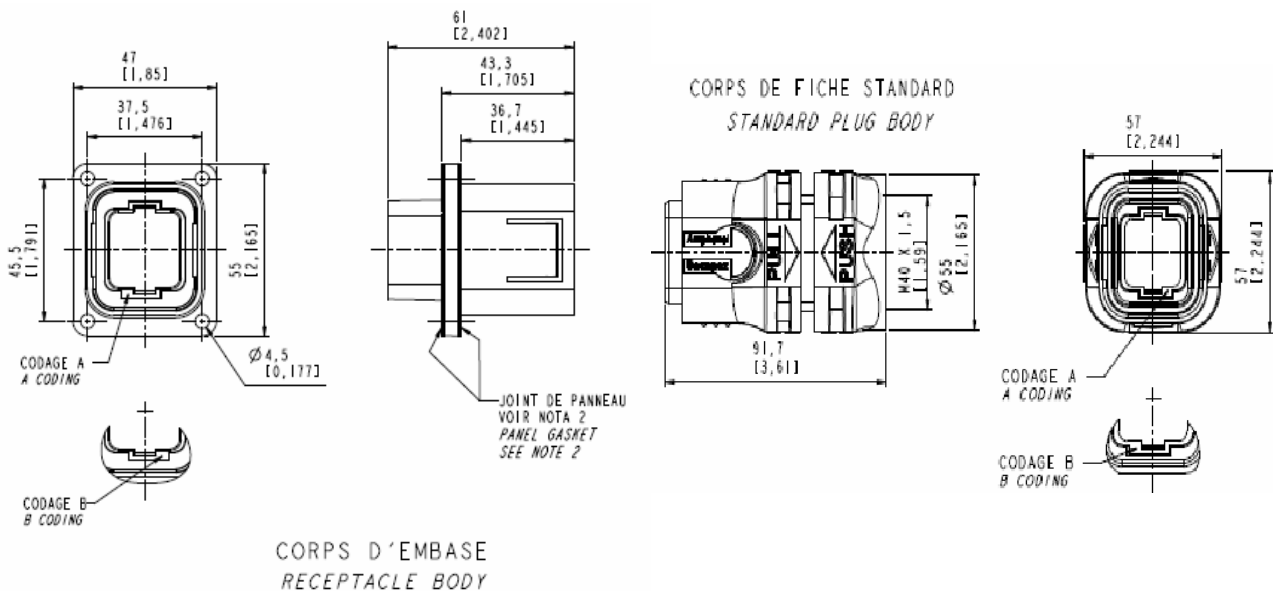

Amphenol

The information given in this document are as a **guideline only**.
 We reserve the right to **modify our products** in any way we deem necessary.
 Any duplication is **prohibited**, unless approved in writing.

Your local Contact:



X-ON Electronics

Largest Supplier of Electrical and Electronic Components

Click to view similar products for [amphenol manufacturer](#):

Other Similar products are found below :

[MS27473P14B18S](#) [GTS02R20-15P-025-116](#) [GTC030-40-68SZ-025-RDS-LC](#) [ACC02E28-51S-003-B30-LC](#) [TV06RL-13-35AD](#) [TV06RL-13-98BD](#) [TV06RL-13-35SD-LC](#) [TV06RL-13-35SD](#) [TV06RL-13-98SD-LC](#) [TV06RL-13-98SD](#) [TVP00RW-23-53AD](#) [100-007-213-002-001](#) [TV06RW-25-90AE](#) [97-3108B16S-5PW-417](#) [PT06J20-24SW](#) [97-3108B16S-4PY-417](#) [97-3108B16S-4PX-417](#) [97-3108B16S-5PY-417](#) [97-3108B16S-4PW-417](#) [CS-DSDMDB37MF-025](#) [97-3108B16S-5PZ-417](#) [TV06RW-25-46AE](#) [TVS07RF-21-16AA](#) [TVS07RF-21-39BA](#) [CF-5A9013-04N](#) [CF-6A4615-06N](#) [GTC02R32-17S-025-RDS](#) [GTC02R32-17S-025-RDS-LC](#) [GTC02R32-17S-025-LC](#) [PT06SE-24-61P\(LC\)](#) [GTC06-22-13SW](#) [GTC06-22-13SY](#) [GTS06G-36-10S](#) [GTC06-22-13S-025-B30-LC](#) [GTC06-22-13SW-025-LC](#) [GTC06-22-13SX-025-B30](#) [GTC06-22-13SZ-025](#) [GTC06-22-13SZ-025-LC](#) [GTC06-22-13S-025-LC](#) [GTC06-22-13SW-025-B30](#) [GTC06-22-13SW-025-B30-LC](#) [GTC06-22-13SX-025-B30-LC](#) [GTC06-22-13SX-025-LC](#) [GTC06-22-13SY-025-B30](#) [GTC06-22-13SY-025-B30-LC](#) [GTC06-22-13SY-025-LC](#) [GTC06-22-13SZ-025-B30](#) [GTC06-22-13SZ-025-B30-LC](#) [GTC06-22-13SW-025](#) [GTC06-22-13SX-025](#)