

SUPER FLUX LED LAMP, 4PIN LED
BL-FL7680xxx
■ Features:

- 7.62*7.62*5.0MM, 5MM ROUND SUPER FLUX LED LAMP, RGB type
- Ultra brightness.
- Wide Viewing Angles.
- Ideal For Backlight and Indicator
- RoHs Compliance

■ Electrical-optical characteristics: (Ta=25°C) (Test Condition: IF=20mA)

Part Number	Chip			Lens Type	Forward Voltage(VF) Unit:V		Luminous Intensity (Iv) Unit:mcd		Viewing Angle 2θ1/2 (deg)
	Emitted Color	Material	λ _p (nm)		Typ	Max	Min.	Typ.	
					BL-FL7680RGBC	Ultra Orange	AlGaInP	630	
	Ultra Pure Green	InGaN	525	3.80	4.50	800	1200		
	Ultra Blue	InGaN	470	2.70	4.20	250	400		

■ Absolute maximum ratings (Ta=25°C)

Parameter	UE	PG	UB	Unit
Forward Current I _F	30	30	30	mA
Power Dissipation P _d	65	110	120	mW
Reverse Voltage V _R	5	5	5	V
Peak Forward Current I _{PF} (Duty 1/10 @1KHZ)	150	150	100	mA
Operation Temperature T _{OPR}	-40 to +80			°C
Storage Temperature T _{STG}	-40 to +85			°C
Lead Soldering Temperature T _{SOL}	Max.260±5°C for 3 sec Max. (1.6mm from the base of the epoxy bulb)			°C

SUPER FLUX LED LAMP, 4PIN LED

BL-FL7680xxx

■ Package configuration & Internal circuit diagram

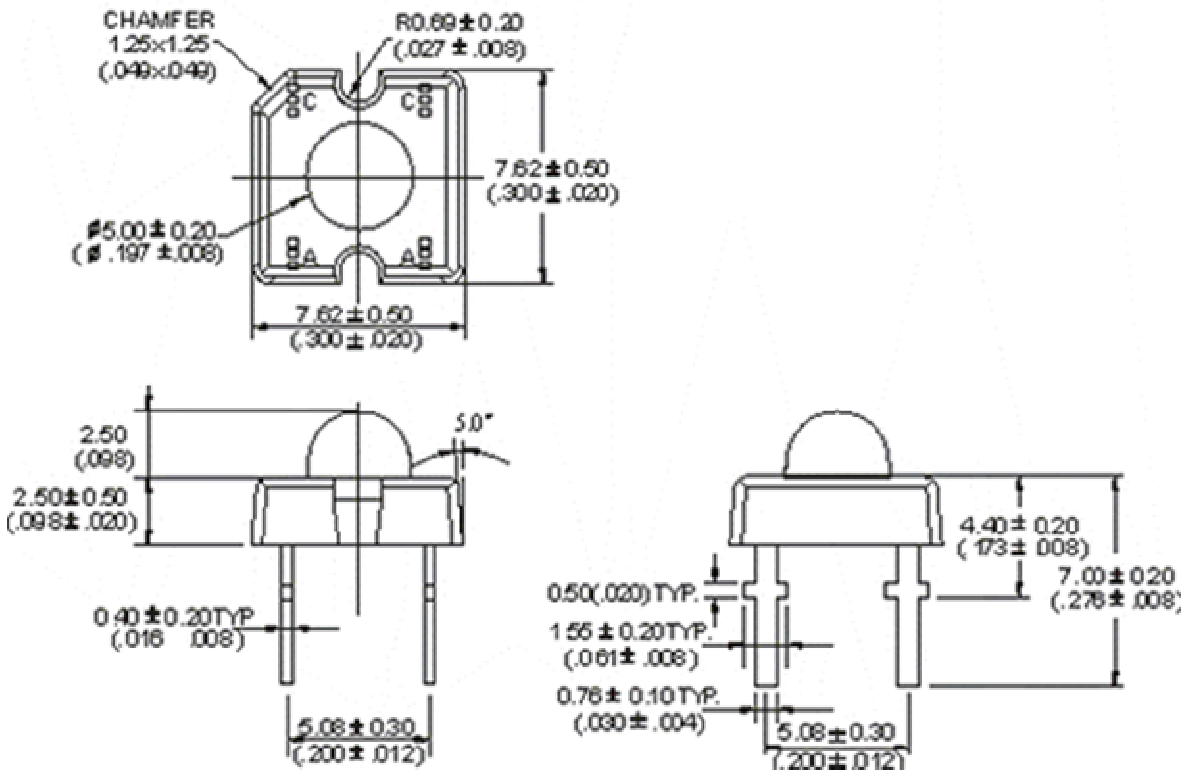

Notes:

1. All dimensions are in millimeters (inches)
2. Tolerance is $\pm 0.25(0.01)$ unless otherwise noted.
3. Specifications are subject to change without notice.

SUPER FLUX LED LAMP, 4PIN LED

BL-FL7680xxx

Typical electrical-optical characteristics curves:



- | | |
|---|--------------------------------------|
| (1) - GaAsP/GaAs 655nm/Red | (9) - GaAlAs 880nm |
| (2) - GaP 570nm/Yellow Green | (10) - GaAs/GaAs & GaAlAs/GaAs 940nm |
| (3) - GaAsP/GaP 585nm/Yellow | (A) - GaN/SiC 430nm/Blue |
| (4) - GaAsP/GaP 635nm/Orange & Hi-Eff Red | (B) - InGaN/SiC 470nm/Blue |
| (5) - GaP 700nm/Bright Red | (C) - InGaN/SiC 505nm/Ultra Green |
| (6) - GaAlAs/GaAs 660nm/Super Red | (D) - InGaN/SiC 525nm/Ultra Green |
| (8) - GaAsP/GaP 610nm/Super Red | |

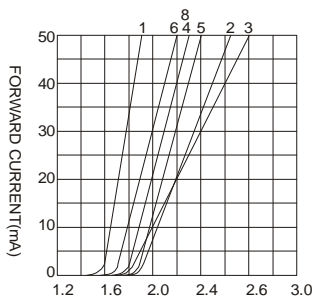

FORWARD VOLTAGE (Vf)
FORWARD CURRENT VS.
FORWARD VOLTAGE

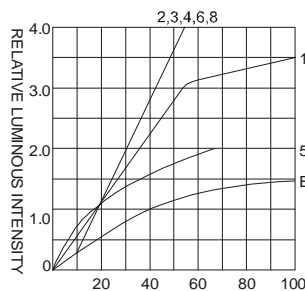

FORWARD CURRENT (mA)
RELATIVE LUMINOUS
INTENSITY VS. FORWARD
CURRENT

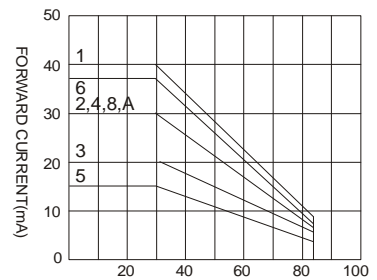

AMBIENT TEMPERATURE Ta(°C)
FORWARD CURRENT VS. AMBIENT
TEMPERATURE

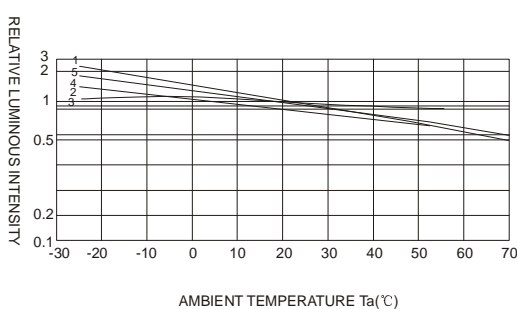

AMBIENT TEMPERATURE Ta(°C)

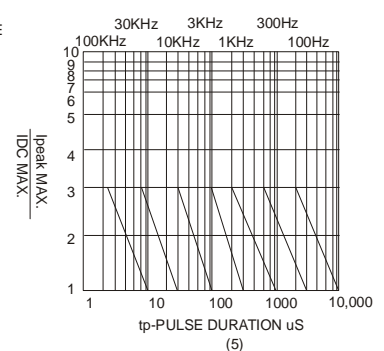
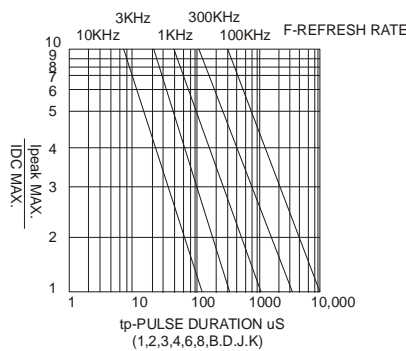

NOTE:25°C free air temperature unless otherwise specified

X-ON Electronics

Largest Supplier of Electrical and Electronic Components

Click to view similar products for [Adafruit Accessories](#) category:

Click to view products by [Amphenol](#) manufacturer:

Other Similar products are found below :

[3015](#) [3209](#) [2998](#) [3561](#) [2974](#) [3182](#) [3290](#) [2755](#) [3560](#) [3562](#) [2503](#) [3548](#) [3011](#) [3597](#) [3048](#) [2776](#) [3299](#) [2973](#) [2922](#) [2958](#) [2860](#) [2836](#) [3558](#)
[2686](#) [2968](#) [2972](#) [2969](#) [2871](#) [2851](#) [2873](#) [2895](#) [3610](#) [2939](#) [2698](#) [3568](#) [2869](#) [2866](#) [3551](#) [2858](#) [2855](#) [3590](#) [3447](#) [3581](#) [3353](#) [2744](#) [3585](#)
[3584](#) [3552](#) [3484](#) [2865](#)