

Miniature circuit-breakers S 200/S 200 M
Residual-current-operated
circuit-breakers F 200
Cross wiring/accessories

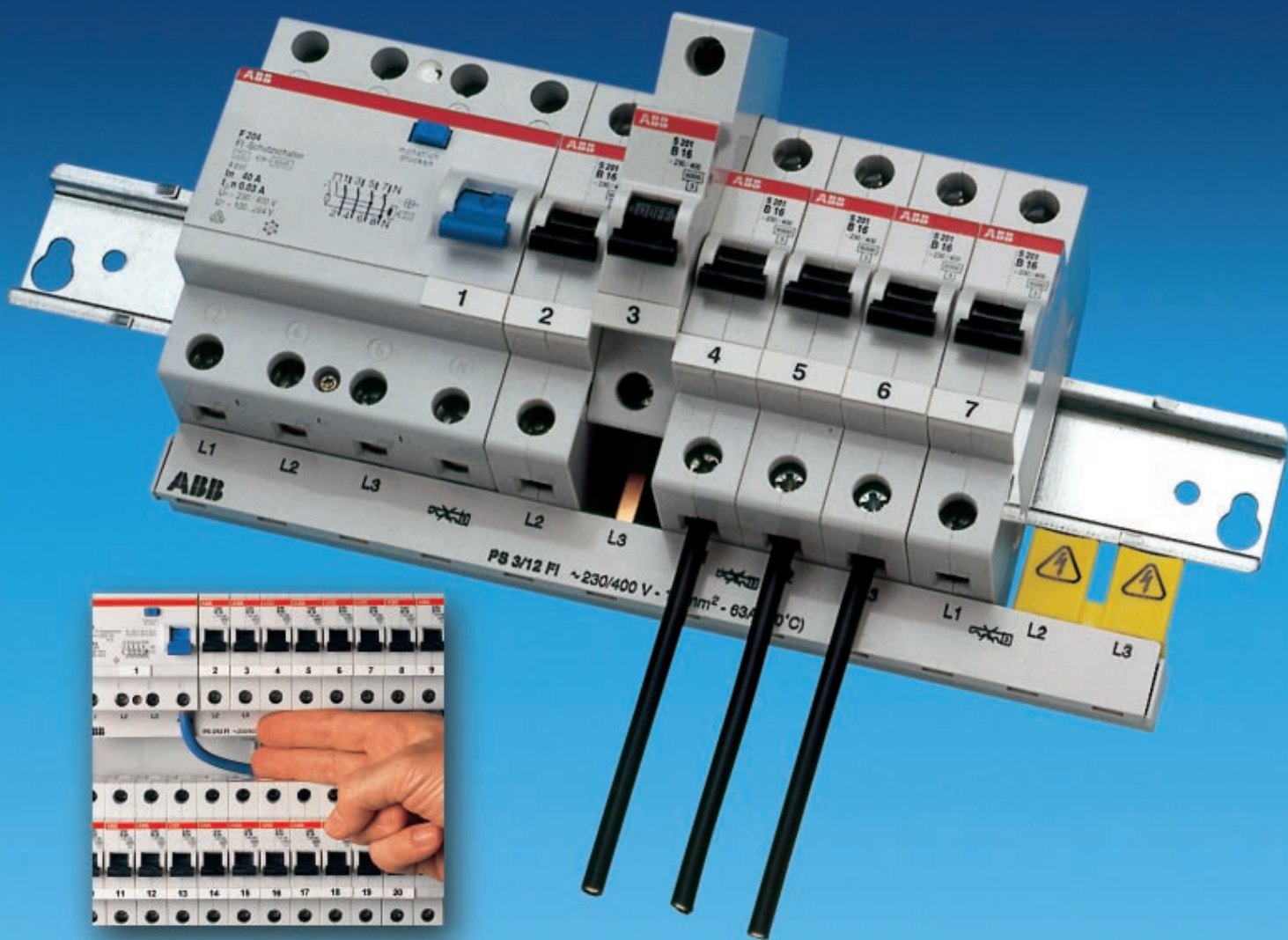

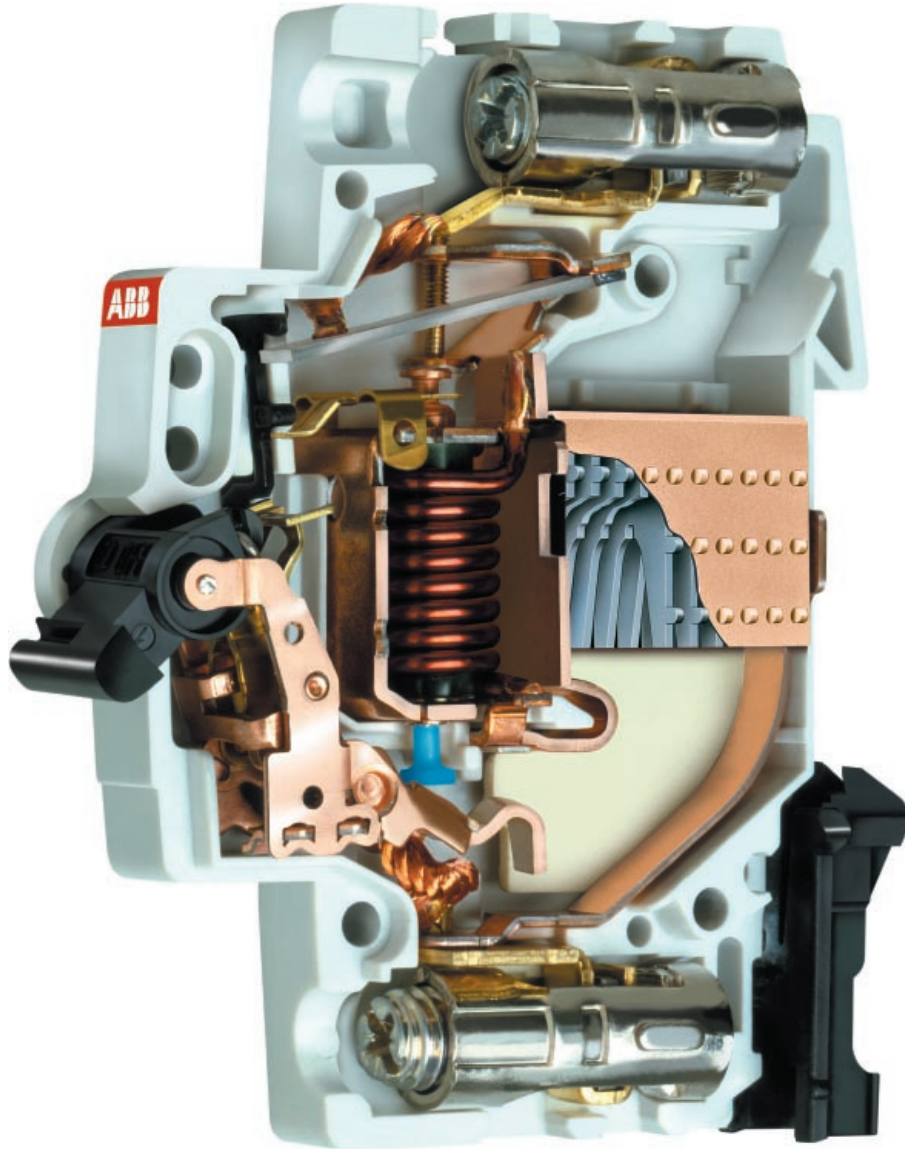

Standard Terms for Delivery and Sale

For domestic business, the Standard Terms for Delivery of Products and Services of the Electrical Industry (ABB Form 2292) shall apply in connection with the Standard Sales Terms (ABB Form 2327) in their then applicable version. For foreign business, the Standard Terms for Delivery of Products and Services of the Electrical Industry (ABB Form 2293 German-English, or ABB Form 2294 German- French) shall apply in connection with the Standard Sales Terms (ABB-Form 2381 English) in their then applicable version.

Warranty

We assume warranty in accordance with the standard sales and delivery terms. Complaints shall be made in writing within eight days following receipt of the goods.

Technical information and illustrations are not binding and subject to change without notice.

Contents

page

The technology of S 200

Notes for use, special features	4
The offer at a glance	6
Overview of technical data	7
Internal resistance and power loss	8
Max. permissible impedances of fault loops	8
Tripping characteristics	9
Short circuit capacity	9
Short circuit selectivity	10
Tripping diagrams	11
Let-through value diagrams	13
Current-carrying capacity, thermal influence	14
Applications S 200	15
Installation and operation instructions S 200	16
Supplementary devices	17
Dimensions	25
Dimension drawings accessories	26

The technology of F 200

Supplementary devices	17
Description, Application examples	20
Technical data	21
Installation and operation instructions F 200	22
Use in different types of circuit	23
Dimension drawings	26
Dimension drawings accessories	27

The technology of busbars

Description	24
Technical data	24
Dimensions	27

The program

Selection table S 200-B	29
Selection table S 200-C	31
Selection table S 200-D	33
Selection table S 200-K	35
Selection table S 200-Z	37
Selection table S 200-K H	39
Selection table S 200 M-B	41
Selection table S 200 M-C	43
Supplementary devices	44
Selection table F 200	45
Selection table busbars, rail connectors	47
Selection table accessories	49

Prior to connection of aluminium conductors ($\geq 4 \text{ mm}^2$) ensure that their contact points are cleaned, brushed and coated with grease.

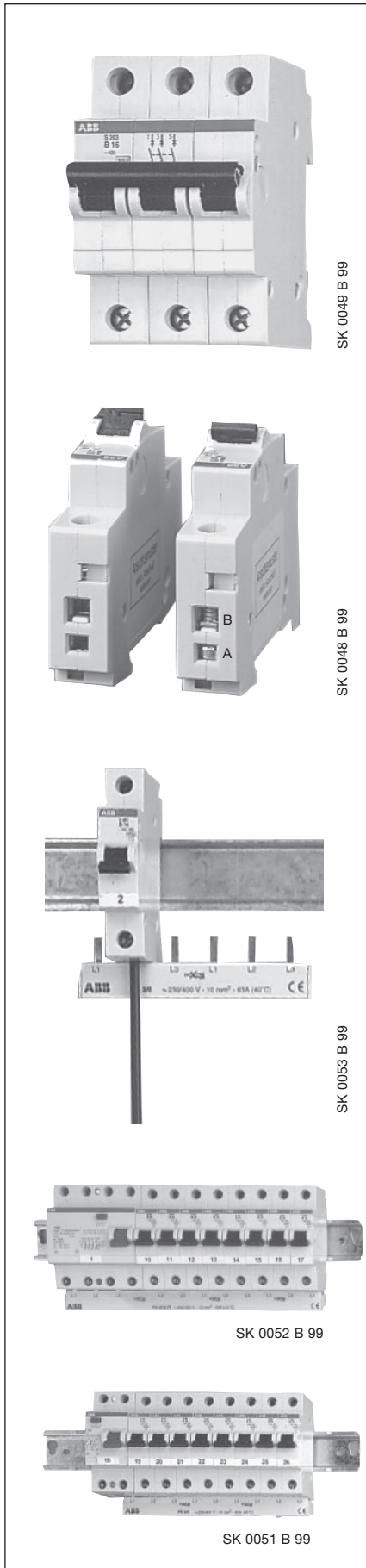

- All round protection against contact with live parts in accordance with DIN VDE 106 part 100.
- Due to new design: Upper and lower shoulders reduced. More working space between component rows. Outgoing and incoming connection points easily accessible.
- New, failsafe, bi-directional cylinder lift terminal, ensuring a faster, totally error-free connection. As you tighten the screw, the terminal draws together to simultaneously close the front and rear wiring inputs. This creates a strong, contact-assured connection between the wires and the device, in a single operation. Busbar is installed at the back terminals (A). Connection of conductors on the front terminals (B). Result: a clear view on all connection points. Never fumble for the right connection point again. Substantially improved cross-wiring safety. Tangible time-savings.
- Connection possible for single, multi and finely stranded conductors of 0.75 to 25 mm². It is also possible to connect conductors with different cross section at the same time.
- New cross wiring busbars. Standard length sizes or meter length cutable.



- New quick-fastening technique for easy disconnection of the device from the assembly.
No time-consuming extra work:
Cross-wiring remains with the assembly.
To remove the device, just loosen the screw, lift the device and pull it out.
If necessary, all devices of the series connected to the new pro M compact cross-wiring rails may be exchanged easily and quickly, e.g. to implement the adaptation to the VDE standard 0100 part 410.
Easy to add on MCB for extensions.

- New, integrated auxiliary contact, factory fitted, reduces space by 50 %.
Cross wiring to customary compact busbar possible.

- Self-adhesive identification labels are provided for all devices, ensuring clear and accurate identification.
Every detail of System pro M compact has now been optimised to meet the user's requirements.
Furthermore, System pro M compact offers you many different ways to label the switchgear cabinet and built-in consumer unit in a professional manner.
Individual, efficient labeling of devices.

- Pad lock prevents unauthorized switching to ON or OFF.

- Complete range of tripping characteristics in B, C, D, K, Z.
- High rated switching capacity of 6 000 A (S 200) or 10 000 A (S 200 M).
- Current limitation is below the values prescribed by the VDE, therefore higher selectivity rating than energy limitation class 3.
- Disconnecter abilities according to DIN VDE 0660 part 107, surge withstand capability 6 kV (1.2/50).

Trip characteristics

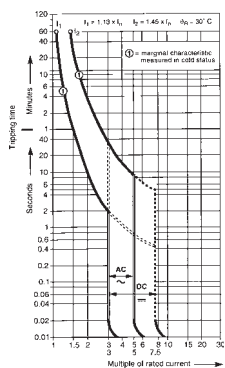

SK 0126 Z 00

B

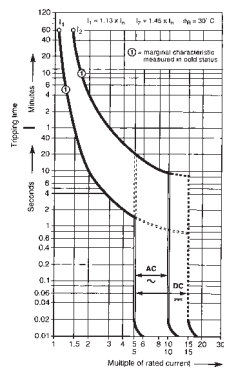

SK 0128 Z 00

C

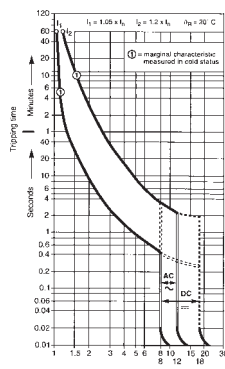

SK 0142 Z 00

D

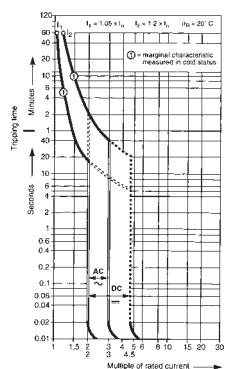

SK 0146 Z 00

K

Description

The MCBs of the S 200/S 200 M series have a current-limiting effect. They have two different trip releases acting on the contact mechanism

1. the delayed thermal release providing overload protection
2. the electromagnetic instantaneous release with "hammer trip" solenoid providing fault current protection.

They offer:

- high short-circuit capacity
- high selectivity for back-up fuse
- In case of short-circuit, low stress on the cable in the point of fault due to the high limitation of the let-through $\int i^2 dt$ (current heating value).

Oscillogram of rupturing process

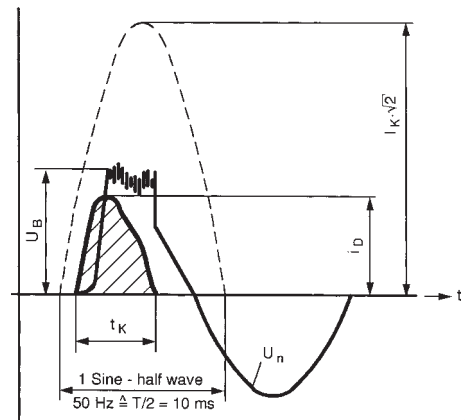

SK 0130 Z 98

Task

To protect against excessive temperature rises of electric items in the case of overcurrents caused by overload, short circuit of earth-fault current if assigned according to DIN VDE 0100 Part 430. Protection against electric shock in the case of excessive touch voltage caused by insulation fault if assigned according to DIN VDE 0100 Part 410.

Trip characteristics and rated current

Independent of the type of characteristic, national codes of practice provide what highest rated current and/or performance characteristic can be assigned to the conductor cross section to be protected (e.g. DIN VDE 0100 Part 430).

The following assignment rules apply: $I_b \leq I_n \leq I_z$; $I_2 \leq 1,45 \cdot I_z$

- I_b = operating current of the circuit to be expected
- I_n = rated current of the MCB of characteristics type B, C, D, K and Z
- I_z = permissible current loading of lines
- I_2 = conventional tripping current

B-, C- and D-type trip characteristics for line protection

Tripping behaviour according to DIN VDE 0641 Part 11. Rated current 6 ... 63 A, (C 0,5 ... 63 A). The introduction of these trip characteristics enables direct assignments of MCBs to the permissible load of lines I_z according to DIN VDE 0298 Part 4/11.98, as the second condition is already fulfilled ($I_2 = 1.45 \cdot I_n$).

K-type trip characteristics

Tripping behaviour according to DIN VDE 0660 Part 101 and IEC 947-2, rated current 0.5 ... 63 A, for circuits where current-consuming apparatus cause functional current peaks and for the overcurrent protection of lines.

Z-type trip characteristics

Tripping behaviour according to DIN VDE 0660 Part 101 and IEC 947-2. Rated current 0.5 ... 63 A in 17 grades. For the protection of semiconductors and measuring circuits with transformers.

Technical data

Specifications:	DIN VDE 0641 Part 11, IEC 60898, EN 60898, IEC 60947-2, UL 1077
No. of poles:	1, 2, 3, 4, 1 + NA, 3 + NA
tripping characteristics:	B, C, D, K, Z
rated current I_n :	B 6 ... 63 A, C, D, K and Z 0,5 ... 63 A
rated voltage U_n :	1-pole 230 V ~ multipole 400 V ~
max. operating voltage U_{Bmax} :	AC $U_n + 10\%$ DC 1-pole 60 V ~ 2-pole 125 V ~
min. operating voltage U_{Bmin} :	12 V~, 12 V-
energy limitation class:	S 3
short circuit rupturing capacity:	see page 9
frequency:	50 ... 60 Hz
insulation coordination:	according to DIN VDE 0110 Part 1 and 2
- overvoltage category:	III
- pollution degree:	2
- surge voltage:	5 kV (1.2/50 μ s)
- impulse alternating voltage:	3 kV (50/60 Hz)
housing: 7035	Insulating material rating I (CTI \geq 600) according to DIN IEC 112/VDE 0303 Part 1, RAL
operating lever:	Insulating material rating II ($400 \leq$ CTI < 600) black, sealable
degree of protection acc. to DIN VDE 0100:	IP 20, in the consumer unit IP 40
dimensions:	according to DIN 43880, size code 1
depth of device:	68 mm
overall dimensions:	see page 25
mounting position:	optional
fixing:	snap-on to DIN rails EN 60 715, 35 mm or screw fixing by means of mounting plate (see accessories)
connection: to	failsafe bi-directional cylinder-lift terminal at top and bottom, shock-protected according to DIN VDE 0106 Part 100. Suitable for connection of single, multi or finely stranded conductors up to 25 mm ² (if also connected to rails)
tightening torque:	2.8 Nm
mechanical service life:	20,000 operations
service life at rated load	
$I_n < 32$ A:	20,000 operations
$I_n \geq 32$ A:	10,000 operations
climatic resistance acc. to DIN IEC 68 Part 2-30:	constant climate 23/83, 40/93, 55/20 [°C/RH] alternating climate 25/95 - 40/93 [°C/RH]
storage temperature:	T_{max} +70 °C/15 _g .F, T_{min} -40 °C/-13 °F
ambient temperature:	T_{max} +55 °C/15 _g .F, T_{min} -25 °C/-13 °F
shock resistance:	30 g, at least 2 impacts shock duration 13 ms
resistance to vibration acc. to DIN IEC 68-2-6:	5 g, 20 frequency cycles 5 ... 150 ... 5 Hz at 0.8 I_n
weight:	see selection tables

Technical data of the integrated auxiliary contact

contact:	1NO (1 make contact) 1NC (1 normally closed contact)
contact load:	AC 14 230 V 2 A DC 12 identical DC 13 DC 13 50 V 1 A
min. operating voltage:	12 VAC/DC at 0.1 VA
short-circuit withstand capacity:	230 V~ 1,000 A
electrical service life:	> 4,000 operations
safe disconnection of auxiliary circuit and main circuit according to VDE 0106 Part 101	
connection capacity:	0.75 to 2.5 mm ² (finely-stranded conductors to be fitted with a connector sleeve)

Internal resistance and power loss of the miniature circuit-breakers

Internal resistance per pole in mΩ, power loss per pole in W

type	rated current I_n A	device series B, C, D Ⓞ		K		Z	
		mΩ	W	mΩ	W	mΩ	W
S 200 and S 200 M	0.5	5500	1.4	6340	1.6	10100	2.5
	1	1440	1.4	1550	1.6	2270	2.3
	1.6	630	1.6	695	1.8	1100	2.8
	2	460	1.8	460	1.9	619	2.5
	3	150	1.3	165	1.5	202	1.8
	4	110	1.8	120	2.0	149	2.4
	6	55	2.0	52	1.9	104	3.7
	8	15	1.0	38	2.5	53.9	3.45
	10	13.3	1.3	12.6	1.26	17.5	1.7
	13	13.3	2.3	12.6	1.26	–	–
	16	7.0	1.8	7.7	2.0	10.9	2.8
	20	6.25	2.5	6.7	2.7	6.0	2.4
	25	5.0	3.2	4.6	2.9	4.1	2.6
	32	3.6	3.7	3.5	3.6	2.8	2.9
	40	3.0	4.8	2.8	4.5	2.5	4.1
	50	1.3	3.25	1.25	2.9	1.8	4.4
	63	1.2	4.8	0.7	5.2	1.3	5.2

Ⓞ Current intensities 0.5 – 4 apply exclusively to C-type trip characteristics.

**Maximum permissible fault loop impedance Z_s at $U_0 = 230 V \sim$ Ⓞ
to ensure compliance with the rupturing conditions prescribed in DIN VDE 0100 Part 410.**

The internal resistance of MCB is included.

Note: Attention should be paid to the maximum voltage drop

S 200 and S 200 M

Bemessungs- strom I_n A	B max. Z_s Ω	C max. Z_s Ω	D max. Z_s Ω	K max. Z_s Ω	Z max. Z_s Ω
0,5		46.0	33.0	38.3	153.3
1		23.0	16.5	19.2	76.7
1.6		14.4	10.3	12.0	47.9
2		11.5	8.2	9.6	38.3
3		7.7	5.5	6.4	25.6
4		5.8	4.1	4.8	19.2
6	7.7	3.8	2.7	3.2	12.8
8	–	2.8	2.1	2.4	9.5
10	4.6	2.3	1.6	1.9	7.7
13	3.5	1.7	1.2	–	–
16	2.9	1.4	1.0	1.2	4.8
20	2.3	1.2	0.8	1.0	3.8
25	1.8	0.9	0.7	0.8	3.1
32	1.4	0.7	0.5	0.6	2.4
40	1.2	0.6	0.4	0.5	1.9
50	0.9	0.5	0.3	0.4	1.5
63	0.7	0.4	0.3	0.3	1.2

Ⓞ U_0 = rated voltage against earthed conductor; for $U_0 = 240 V \sim$: $Z_s \cdot 1.04$; for $U_0 = 127 V \sim$: $Z_s \cdot 0.55$
The max. permissible length of cable at different voltage and cross sections on request.

Tripping characteristics

acc. to	tripping characteristic and rated current		thermal release ^①		tripping time	electromagnetic release ^②		tripping time
			current: conventional non-tripping c.	conventional tripping c.		currents: hold current surges	trip at least at	
DIN VDE 0641/T 11	B	6 to 63 A	$1.13 \cdot I_n$	$1.45 \cdot I_n$	> 1 h < 1 h	$3 \cdot I_n$	$5 \cdot I_n$	> 0.1 s < 0.1 s
	C	0.5 to 63 A	$1.13 \cdot I_n$	$1.45 \cdot I_n$	> 1 h < 1 h	$5 \cdot I_n$	$10 \cdot I_n$	> 0.1 s < 0.1 s
	D	0.5 to 63 A	$1.13 \cdot I_n$	$1.45 \cdot I_n$	> 1 h < 1 h	$10 \cdot I_n$	$20 \cdot I_n$	> 0.1 s < 0.1 s
DIN VDE 0660/9.82	K	0.5 to 63 A	$1.05 \cdot I_n$	$1.2 \cdot I_n$	> 1 h < 1 h	not applicable		
DIN VDE 0660 8/69 Part 1 ^③			$1.05 \cdot I_n$	$1.2 \cdot I_n$ $1.5 \cdot I_n$ $6.0 \cdot I_n$	> 2 h < 2 h ^④ < 2 min. ^④ > 2 s (T1)	$8 \cdot I_n$	$12 \cdot I_n$	> 0.2 s < 0.2 s
DIN VDE 0660/9.82	Z	0.5 to 63 A	$1.05 \cdot I_n$	$1.2 \cdot I_n$	> 1 h < 1 h	not applicable		
DIN VDE 0660 8/69 Part 1 ^③			$1.05 \cdot I_n$	$1.2 \cdot I_n$ $1.5 \cdot I_n$ $6.0 \cdot I_n$	> 2 h < 2 h ^④ < 2 min. ^④ > 2 s (T1)	$2 \cdot I_n$	$3 \cdot I_n$	> 0.2 s < 0.2 s

① The indicated tripping values of electromagnetic tripping devices apply to a frequency range of 16 2/3 ... 60 Hz. In the case of diverging frequencies or direct current, the values change by the factor indicated below

factor ca.	alternating current			direct current
	100 Hz	200 Hz	400 Hz	
	1.1	1.2	1.5	1.5

The thermal release operates independently of voltages.

② The thermal releases are calibrated to a nominal reference ambient temperature; for Z and K, the value is 20 °C, for B and C = 30 °C. In the case of higher ambient temperatures, the current values fall by ca. 6% for each 10 K temperature rise.

③ as from operating temperature (after $I_1 > 1$ h or, as applicable, 2 h).

④ The standard DIN VDE 0660/9.69 has expired in 1986, but is still referred to due to its complete statement of the tripping characteristics.

Short circuit rupturing capacity and back-up

operating sequence: **B and C according to DIN VDE 0641, DIN VDE 0660 Part 101 I_{cs} K and Z according to IEC 947**

series	trip characteristic	1phase 133 V ~	alternating current				direct current	Max. back-up	
			230 V ~	2/3phase 230 V ~	400 V ~ 133/230 V ~	1pole ^① 60 V ... 230/400 V ~		kA/T ≤ ms	fuse gL ^②
S 200-B	A	6	10/0.5	6/0.7	10/0.5	6/0.7	10/4.0	63 A	100 A
S 200 M-B	10 ... 20	100 A						100 A	
	25 ... 32	100 A						100 A	
	40	125 A						100 A	
	50 ... 63	160 A						100 A	
S 200-C	0.5 ... 2	unlimited				not required			
S 200 M-C	3 ... 4	10/0.5	6/0.7	10/0.5	6/0.7	10/4.0	20 A	-	
S 200-D	6						40 A	100 A	
	8						63 A	100 A	
	10 ... 20						100 A	100 A	
	25 ... 32						100 A	100 A	
	40						125 A	100 A	
50 ... 63	160 A	100 A							
S 200-K	0.5 ... 2	unlimited				not required			
	3	10/0.5	6/0.7	10/0.5	6/0.7	10/4.0	20 A	-	
	4						25 A	-	
	6 ... 10						63 A	100 A	
	16 ... 20						80 A	100 A	
	25 ... 32						100 A	100 A	
	40						125 A	100 A	
50 ... 63	160 A	100 A							
S 200-Z	0.5 ... 2	unlimited				not required			
	3 ... 4	10/0.5	6/0.7	10/0.5	6/0.7	10/4.0	20 A	-	
	6						35 A	100 A	
	8						40 A	100 A	
	10 ... 16						63 A	100 A	
	20 ... 25						80 A	100 A	
	32 ... 40						100 A	100 A	
	50 ... 63						125 A	100 A	

① In symmetrically earthed direct current circuits, 2-pole devices (two poles connected in series) can be used up to 110 VDC. Any connection is possible, polarity does not need to be taken into account.

② Back-up protection is necessary only if the solid short-circuit current to be expected at the place of installation may exceed the switching capacity indicated.

Short circuit selectivity: In the case of a short circuit, selectivity exists up to the values indicated.

series	I_n A	short circuit discrimination in kA									to fuse gL/gG (DIN VDE 0636; IEC 269/3)												
		16	20	25	35	40	50	63	80	100	16	20	25	35	50	63	80	100	125	160			
S 200-B, C, D Current values smaller than 6 A and 8 A, apply only to C and D characteristics.	≤ 2	>15	>15	>15	>15	>15	>15	>15	>15	>15	1	1.2	4	>15	>15	>15	>15	>15	>15	>15	>15	>15	
	3	10	10	10	10	10	10	10	8	8	0.3	0.7	1.2	4.6	6	6	6	6	6	6	6	6	6
	4	10	10	10	10	10	10	10	8	8	0.3	0.6	0.9	2.8	6	6	6	6	6	6	6	6	6
	6	10	10	10	10	10	10	10	8	8	0.2	0.5	0.8	2	3.3	5.5	6	6	6	6	6	6	6
	8	10	10	10	10	10	10	10	8	8	0.2	0.4	0.7	1.7	2.8	4.5	6	6	6	6	6	6	6
	10	10	10	10	10	10	10	10	8	8	0.2	0.4	0.7	1.5	2.5	3.5	5	6	6	6	6	6	6
	13	10	10	10	10	10	10	10	8	8			0.7	1.5	2.5	3.5	5	6	6	6	6	6	6
	16	10	10	10	10	10	10	10	8	8				1.3	2	2.9	4.1	6	6	6	6	6	6
	20		10	10	10	10	10	10	8	8					1.8	2.6	3.5	5	6	6	6	6	6
	25			10	10	10	10	10	8	8					1.8	2.6	3.5	5	6	6	6	6	6
	32				10	10	10	10	8	8						2.2	3	4	6	6	6	6	6
	40		**			10	10	10	8	8						2.5	4	6	6	6	6	6	6
	50/63						10	10	8	8								3.5	5	6	6	6	6
S 200 M-B, C Current values smaller than 6 A and 8 A, apply only to C characteristics.	≤ 2	>15	>15	>15	>15	>15	>15	>15	>15	>15	1	1.2	4	>15	>15	>15	>15	>15	>15	>15	>15	>15	
	3	15	15	15	15	15	15	15	10	10	0.3	0.7	1.2	4.6	6	6	6	6	6	6	6	6	6
	4	15	15	15	15	15	15	15	10	10	0.3	0.6	0.9	2.8	6	6	6	6	6	6	6	6	6
	6	15	15	15	15	15	15	15	10	10	0.2	0.5	0.8	2	3.3	5.5	6	6	6	6	6	6	6
	8	15	15	15	15	15	15	15	10	10	0.2	0.4	0.7	1.7	2.8	4.5	6	6	6	6	6	6	6
	10	15	15	15	15	15	15	15	10	10	0.2	0.4	0.7	1.5	2.5	3.5	5	6	6	6	6	6	6
	13	15	15	15	15	15	15	15	10	10			0.7	1.5	2.5	3.5	5	6	6	6	6	6	6
	16	15	15	15	15	15	15	15	10	10				1.3	2	2.9	4.1	6	6	6	6	6	6
	20		15	15	15	15	15	15	10	10					1.8	2.6	3.5	5	6	6	6	6	6
	25			15	15	15	15	15	10	10					1.8	2.6	3.5	5	6	6	6	6	6
	32				15	15	15	15	10	10						2.2	3	4	6	6	6	6	6
	40		**			15	15	15	10	10						2.5	4	6	6	6	6	6	6
	50/63					15	15	10	10	10							3.5	5	6	6	6	6	6
S 200-K Selectivity values apply to I_{cu} according to IEC 947-2.	≤ 2	>15	>15	>15	>15	>15	>15	>15	>15	>15	0.3	1.2	4	>15	>15	>15	>15	>15	>15	>15	>15	>15	
	3	10	10	10	10	10	10	10	10	10	0.3	0.7	1.2	4.6	6	6	6	6	6	6	6	6	6
	4	10	10	10	10	10	10	10	10	10	0.3	0.6	0.9	2.8	6	6	6	6	6	6	6	6	6
	6	10	10	10	10	10	10	10	10	10			0.7	1.7	3	5.9	6	6	6	6	6	6	6
	8	10	10	10	10	10	10	10	10	10				1.3	2.2	3.6	6	6	6	6	6	6	6
	10	10	10	10	10	10	10	10	10	10					1.7	2.5	4	6	6	6	6	6	6
	16	10	10	10	10	10	10	10	10	10						2.2	3.1	4.6	6	6	6	6	6
	20		10	10	10	10	10	10	10	10							3.1	4.6	6	6	6	6	6
	25			10	10	10	15	10	10	10							2.6	3.5	6	6	6	6	6
	32				10	10	10	10	10	10								3.5	6	6	6	6	6
	40		**			10	10	10	10	10									5.5	6	6	6	6
	50/63					10	10	10	10	10													6
	S 200 Z Selectivity values apply to I_{cu} according to IEC 947-2.	≤ 2	>15	>15	>15	>15	>15	>15	>15	>15	>15	0.5	2	>15	>15	>15	>15	>15	>15	>15	>15	>15	>15
3		10	10	10	10	10	10	10	10	10	0.3	0.7	1.2	6	6	6	6	6	6	6	6	6	6
4		10	10	10	10	10	10	10	10	10	0.3	0.6	1.3	7	6	6	6	6	6	6	6	6	6
6		10	10	10	10	10	10	10	10	10	0.2	0.5	0.9	2.7	6	6	6	6	6	6	6	6	6
8		10	10	10	10	10	10	10	10	10	0.2	0.5	0.6	1.7	3.8	6	6	6	6	6	6	6	6
10		10	10	10	10	10	10	10	10	10			0.4	0.6	1.3	2.4	4	6	6	6	6	6	6
16		10	10	10	10	10	10	10	10	10				0.5	1.1	1.7	3	4.5	6	6	6	6	6
20			10	10	10	10	10	10	10	10					0.9	1.5	2.3	3.5	5.2	6	6	6	6
25				10	10	10	15	10	10	10						1.4	2	3	4	6	6	6	6
32					10	10	10	10	10	10						1.4	2	3	4	6	6	6	6
40			**			10	10	10	10	10							2	3	4	6	6	6	6
50/63						10	10	10	10	10							2.2	3.5	5.8	6	6	6	6

**** Limited or no selectivity at all possible in the overload range (thermal tripping)**

The above values require that, in the case of multi-phase installations, that the last cb be feed from above.

Tripping diagrams

Reading example for tripping characteristic of the B-type trip characteristics (in connection with the table **tripping characteristics** on page 9, line **B**)

a Thermal tripping characteristic:

Conventional non-tripping current I_1 = selected non-tripping current
The MCB maintains the 1.13 times of the rated current for at least 60 minutes.
Conventional tripping current I_2 = selected tripping current.
The MCB switches off within 60 minutes when the 1.45 times of the rated current is reached.

b Electromagnetic trip characteristic AC:

The MCB maintains current rushes of the 3-fold of the rated current for more than 0.1 sec. (in this example up to ca. 4 sec.).

The MCB switches off within less than 0.1 sec when the 5-times of the rated current is reached.

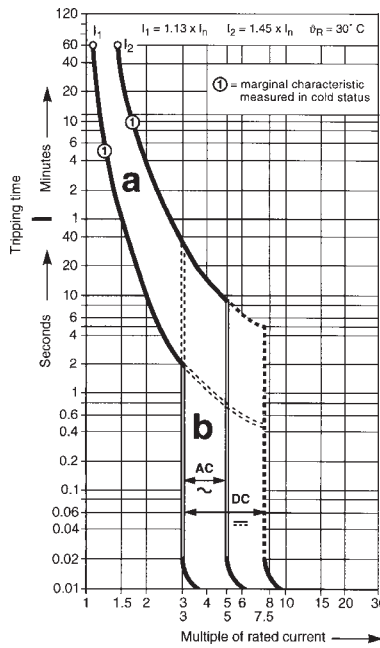

SK 0038 Z 01

trip characteristic: B
 $I_n = 6 \dots 63 \text{ A}$
S 200/S 200 M MCBs

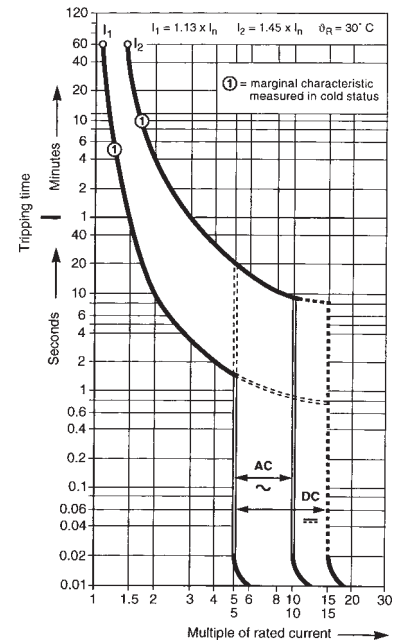

SK 0128 Z 00

trip characteristic: C
 $I_n = 0.5 \dots 63 \text{ A}$
S 200/S 200 M MCBs

Note: Deviating ambient temperature values and interdependencies need to be taken into account

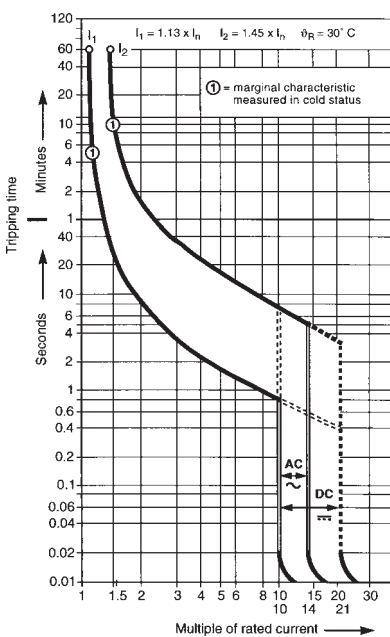

2CDC 022 377 F0203

trip characteristic: D
 $I_n = 0.5 \dots 63 \text{ A}$
S 200 MCBs

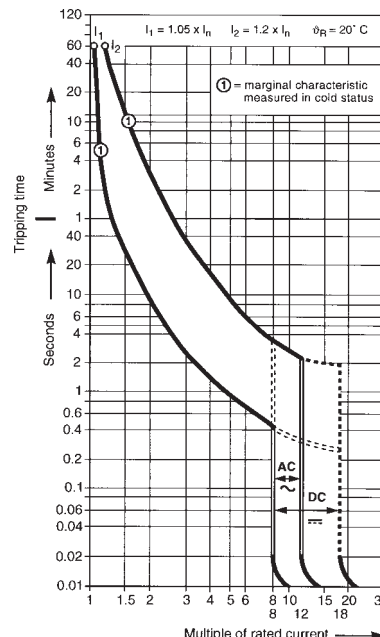

SK 0142 Z 00

trip characteristic: K
 $I_n = 0.5 \dots 63 \text{ A}$
S 200 MCBs

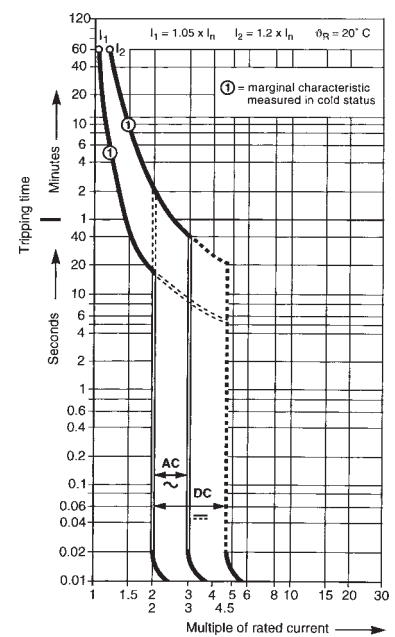

SK 0146 Z 00

trip characteristic: Z
 $I_n = 0.5 \dots 63 \text{ A}$
S 200 MCBs

Pulse tripping of the MCBs S 200/S 200 M made by ABB-STOTZ-KONTAKT

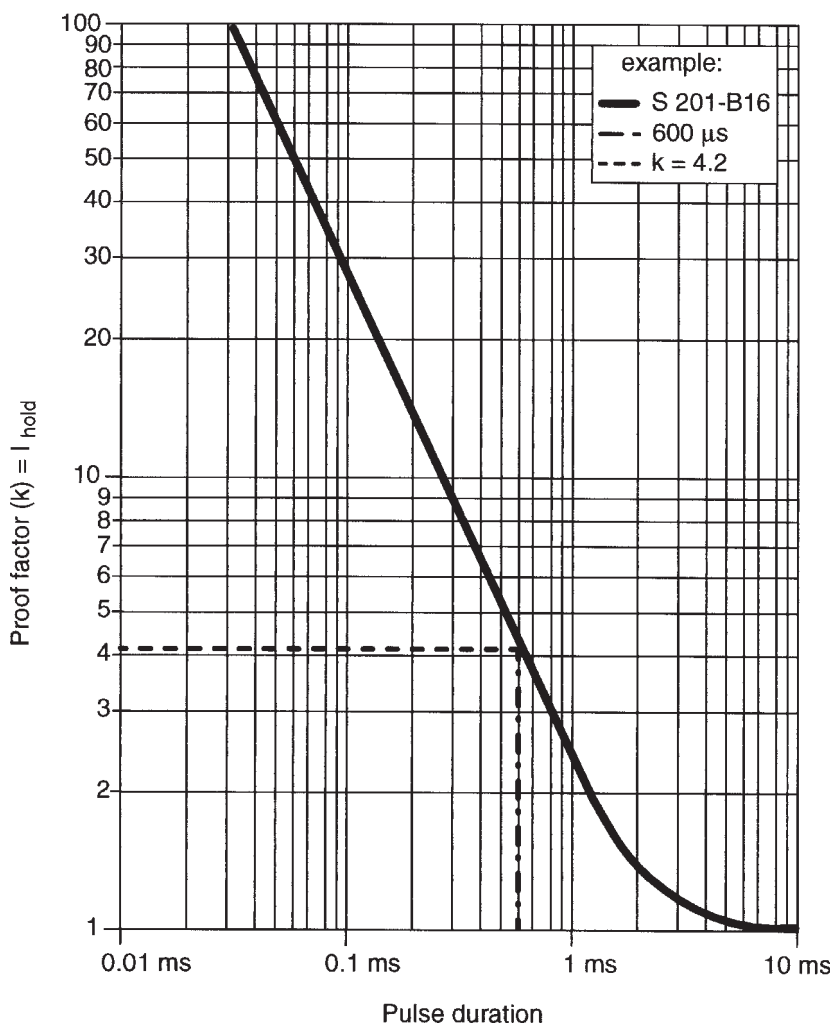

2CDC 022 131 F0203

Example:

S 201-B16

$I_{hold} = K \times \text{non-tripping current}$

$I_{hold} = 4.2 \times 3 \times 16$

$I_{hold} = 201.6 \text{ A}$

non-tripping current (electromagnetic release)

B-type characteristic = $3 \times I_n$

C-type characteristic = $5 \times I_n$

D-type characteristic = $10 \times I_n$

K-type characteristic = $10 \times I_n$

Z-type characteristic = $2 \times I_n$

In the case of an impulse of 600μ , S 201-B16 maintains up to a current of 201.6 A.

Diagrams of let-through values $I^2 t$ at 230/400 VAC

Miniature circuit-breakers S 200 B/C, D on request

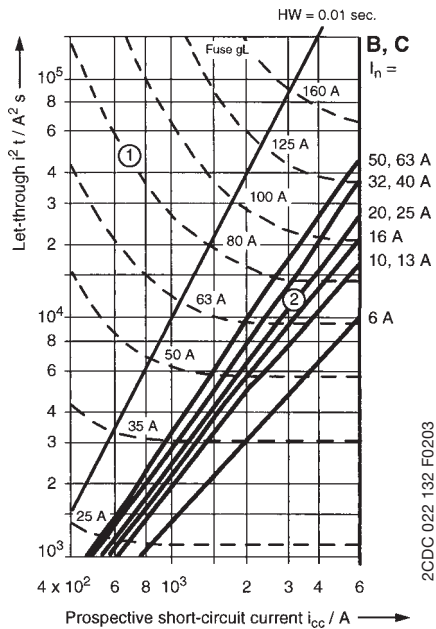

Miniature circuit-breakers S 200 K

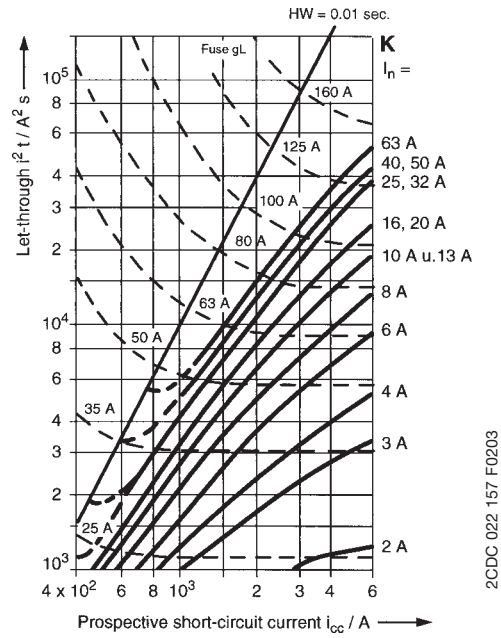

- ① min. pre-arcing I^2t , e.g. $I_n = 80$ A gL
- ② max. let-through I^2t MCB e.g. B20 A

- Fuse-MCB, selectivity with respect to the upstream fuse to the point of intersection of both curves ① and ②, e.g. S 200-B20 to fuse 80 A: selectivity up to 3.5 kA min.
- Let-through value I^2t reduced:
127 V~ by factor 2.5
110 V~ by factor 3

Miniature circuit-breakers S 200 Z

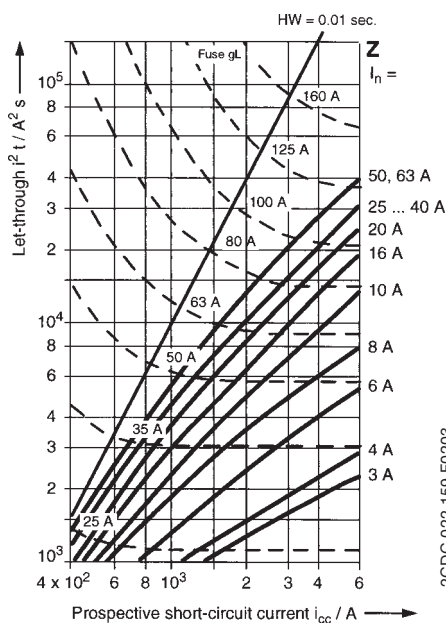

Miniature circuit-breakers S 200 M B/C

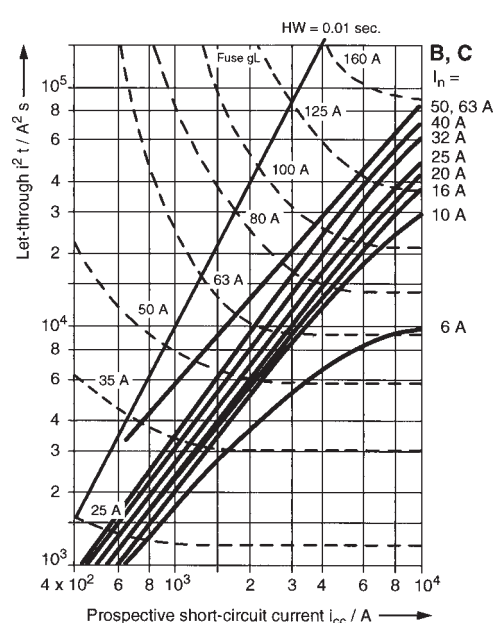

The influence of ambient temperature and interdependencies in the case of even loads on the load capability of MCBs

Practical Note: This practical deduction, that is applicable for all types of characteristics, can be recommended for standard environments. Selection criteria for rated current of circuit-breakers according to EN 60898 and EN 60947-2.

Choose the circuit-breaker that is appropriate for the lower of the rated value of the device or the permissible current loading. Now, the major factors having an influence on the circuit-breaker, must be taken into account:

1. ambient temperature with $I_b \leq 0.9 \times I_n$ at 40 °C ambient temperature
2. mutual influence with $I_b \leq 0.75 \times I_n$ in the case of more than one circuit-breaker being loaded evenly in parallel.

The ensuing rated current of the circuit breaker is thus: $I_n = 1.5 \times \text{rated current}$

Example: operating current 4 A, then the rated current of the circuit-breaker is: $I_n = 1.5 \times 4 \text{ A} = 6 \text{ A}$

The above takes into account all relevant factors and the circuit is protected at the lowest possible level.

This practical note is based on the following:

1. Deviating ambient temperature: The thermal releases are adapted to a given reference ambient temperature. For the K- and Z-type characteristics, it is 20 °C, for B-, C- and D-type, it is 30 °C.

For all other ambient temperatures, the current values indicated vary by **ca. 6 % per 10 K temperature de/increase**.

For more precise calculations and very high/low ambient temperatures, the following tables apply:

Max. operating current depending on the ambient temperature circuit-breaker in load circuit of characteristics type B, C and D

B, C and D	Ambient temperature T (°C)											
	-40	-30	-20	-10	0	10	20	30	40	50	60	70
I_n (A)												
0.5	0.67	0.65	0.62	0.60	0.58	0.55	0.53	0.50	0.47	0.44	0.41	0.37
1.0	1.33	1.29	1.25	1.20	1.15	1.11	1.05	1.00	0.94	0.88	0.82	0.75
1,6	2.13	2.07	2.00	1.92	1.85	1.77	1.69	1.60	1.51	1.41	1.31	1.19
2,0	2.67	2.58	2.49	2.40	2.31	2.21	2.11	2.00	1.89	1.76	1.63	1.49
3,0	4.0	3.9	3.7	3.6	3.5	3.3	3.2	3.0	2.8	2.6	2.4	2.2
4,0	5.3	5.2	5.0	4.8	4.6	4.4	4.2	4.0	3.8	3.5	3.3	3.0
6,0	8.0	7.7	7.5	7.2	6.9	6.6	6.3	6.0	5.7	5.3	4.9	4.5
8,0	10.7	10.3	10.0	9.6	9.2	8.8	8.4	8.0	7.5	7.1	6.5	6.0
10,0	13.3	12.9	12.5	12.0	11.5	11.1	10.5	10.0	9.4	8.8	8.2	7.5
13,0	17.3	16.8	16.2	15.6	15.0	14.4	13.7	13.0	12.3	11.5	10.6	9.7
16,0	21.3	20.7	20.0	19.2	18.5	17.7	16.9	16.0	15.1	14.1	13.1	11.9
20,0	26.7	25.8	24.9	24.0	23.1	22.1	21.1	20.0	18.9	17.6	16.3	14.9
25,0	33.3	32.3	31.2	30.0	28.9	27.6	26.4	25.0	23.6	22.0	20.4	18.6
32,0	42.7	41.3	39.9	38.5	37.0	35.4	33.7	32.0	30.2	28.2	26.1	23.9
40,0	53.3	51.6	49.9	48.1	46.2	44.2	42.2	40.0	37.7	35.3	32.7	29.8
50,0	66.7	64.5	62.4	60.1	57.7	55.3	52.7	50.0	47.1	44.1	40.8	37.3
63,0	84.0	81.3	78.6	75.7	72.7	69.6	66.4	63.0	59.4	55.6	51.4	47.0

Max. operating current depending on the ambient temperature circuit-breaker in load circuit of characteristics type K and Z

K and Z	Ambient temperature T (°C)											
	-40	-30	-20	-10	0	10	20	30	40	50	60	70
I_n (A)												
0.5	0.66	0.64	0.61	0.59	0.56	0.53	0.50	0.47	0.43	0.40	0.35	0.31
1.0	1.32	1.27	1.22	1.17	1.12	1.06	1.00	0.94	0.87	0.79	0.71	0.61
1.6	2.12	2.04	1.96	1.88	1.79	1.70	1.60	1.50	1.39	1.26	1.13	0.98
2.0	2.65	2.55	2.45	2.35	2.24	2.12	2.00	1.87	1.73	1.58	1.41	1.22
3.0	4.0	3.8	3.7	3.5	3.4	3.2	3.0	2.8	2.6	2.4	2.1	1.8
4.0	5.3	5.1	4.9	4.7	4.5	4.2	4.0	3.7	3.5	3.2	2.8	2.4
6.0	7.9	7.6	7.3	7.0	6.7	6.4	6.0	5.6	5.2	4.7	4.2	3.7
8.0	10.8	10.2	9.8	9.4	8.9	8.5	8.0	7.5	6.9	6.3	5.7	4.9
10.0	13.2	12.7	12.2	11.7	11.2	10.6	10.0	9.4	8.7	7.9	7.1	6.1
13.0	17.2	16.6	15.9	15.2	14.5	13.8	13.0	12.2	11.3	10.3	9.2	8.0
16.0	21.2	20.4	19.6	18.8	17.9	17.0	16.0	15.0	13.9	12.6	11.3	9.8
20.0	26.5	25.5	24.5	23.5	22.4	21.2	20.0	18.7	17.3	15.8	14.1	12.2
25.0	33.1	31.9	30.6	29.3	28.0	26.5	25.0	23.4	21.7	19.8	17.7	15.3
32.0	42.3	40.8	39.2	37.5	35.8	33.9	32.0	29.9	27.7	25.3	22.6	19.6
40.0	52.9	51.0	49.0	46.9	44.7	42.4	40.0	37.4	34.6	31.6	28.3	24.5
50.0	66.1	63.7	61.2	58.6	55.9	53.0	50.0	46.8	43.3	39.5	35.4	30.6
63.0	83.3	80.3	77.2	73.9	70.4	66.8	63.0	58.9	54.6	49.8	44.5	38.6

2. Interdependencies in the case of even loads

A correction factor must be taken into account in the case butt-mounted devices and an evenly applied, high load:

2 and 3 circuit-breakers with factor 0.9

4 and 5 circuit-breakers with factor 0.8

6 and more circuit-breakers with factor 0.75

The interdependency becomes irrelevant if FST ... spacers or packing blocks (9mm width) are used.

Use of S 200/S 200 M miniature circuit-breakers in direct current circuits 60 VDC/125 VDC

In DC systems up to 60 VDC or, as the case may be, series connection up to 125 VDC, customary S 200/S 200 M series MCBs can be used. Polarity does not need to be taken into consideration, the outgoing circuit may be implemented from above or below the device.

For higher direct voltage up to 440 VDC devices of the S 280 UC series must be used.

Example for max. permissible voltages between conductors depending on the number of poles and type of connection.

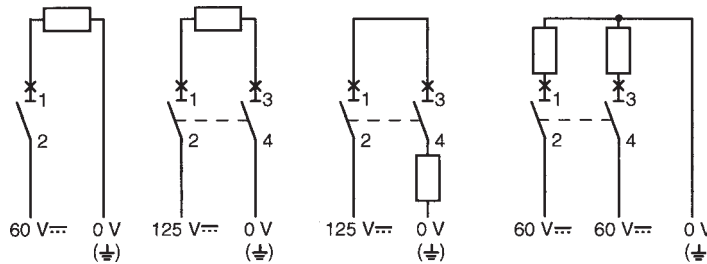

Examples for different voltages between a conductor and earth where voltages between conductors are identical:

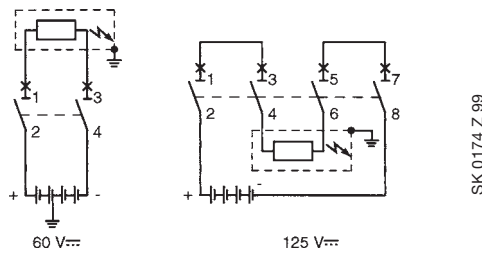

Fusing of lighting currents

1. Filament lamps and fluorescent lamps

The following table indicates the maximum number of fluorescent lamps that can be protected with a single-pole miniature circuit-breaker. In the case of multipole MCBs, the value is reduced by 20 %. Tripping characteristic type C allows for light currents up to the rated current of the MCB, for fusing of:

- filament lamps
- fluorescent lamps
 - a) non-compensated
 - b) shunt compensated ($\cos \varphi = 0.95$)
 - c) electronic load

Characteristic/ rated current	non-compensated conventional ballast			shunt compensated conventional ballast			electronic ballast ^①		
	18/20 W	36/40 W	58/65 W	18/20 W	36/40 W	58/65 W	18/20 W	36/40 W	58/65 W
10	27	23	15	32	32	20	18	18	8
16	43	37	24	51	51	33	26	26	12
20	53	46	30	64	64	41	33	33	15
25	66	58	37	82	82	53	42	42	19

① electronic ballast: twin-lamp style, jointly switched number of lamps

2. High-pressure discharge lamps

Starting current: ca. 1.7 x lamp current
Recovery time: ca. 3 ... 5 min.

According to the type of lamp, line impedance and start-stop torque, the so-called rectifier effect may occur which superimposes the starting current of the lamp for some half-waves.

In the most unfavorable circumstances, inrush currents of 15 times of the lamp nominal current may ensue.

To avoid nuisance tripping, MCBs with K-type characteristic should not carry loads higher than 0.6-fold of the lamp current. The load factor indicated refers to the least favorable case (proximity to transformer, low line impedances).

Installation and operation instructions

Installation

Can be installed in any mounting position due to snap-on fixing to DIN rails EN 60 715, 35 mm width.

- A** If MCB S 200/S 200 M is installed without cross wiring, hinge the upper part into the DIN rail and push to let the lower part of the device snap into place **(1)**. The device is released in the reverse order, after the quick fastener has been removed with a screw driver **(2)**.
- B** To release S 200 /S 200 M that are cross-wired with **System pro M compact** busbars, first remove the clamping screws. Then, pull the lower part of the S 200/S 200 M forwards **(1)** and lift it straight up **(1a)**, then, the quick fastener **(1b)** will recede.
- C** The busbar is deallocated and the S 200/S 200 M can be pulled out by lifting the device forwards **(2)**.
- D** The cross-wiring is re-inserted in the reverse order. First, open the clamping screws and pull out the quick fastener **until it locks into place for the first time (3)**. Then, take the S 200 /S 200 M and insert it with rear terminal side onto the pins of the **System pro M compact** busbar **(4)**, turn it into the direction of the DIN rail **(4a)** and shift it vertically downwards **(4b)**, this way, the quick fastener snaps back into place **(4c)**.

Attention: Do not forget to re-tighten the clamping screws.

A Assembly, disassembly without pro M compact cross wiring

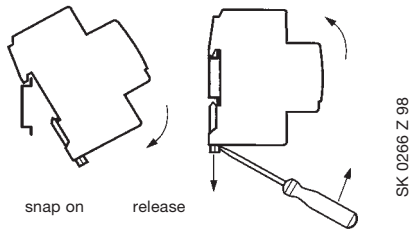

B Detaching when pro M compact cross wiring remains in place

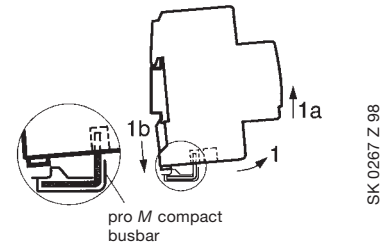

C Removal when pro M compact cross wiring remains in place

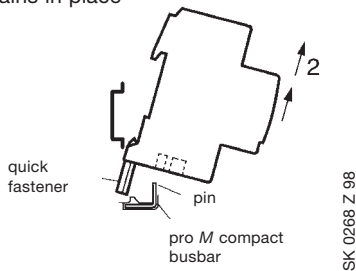

D Insertion when pro M compact cross wiring remains in place

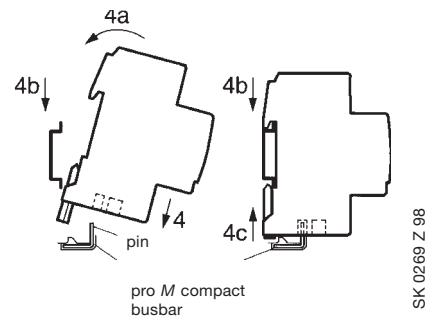
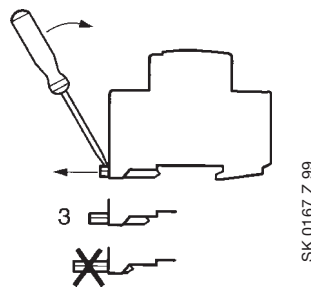

Operation

MCBs are switched on by switching the operating lever into the upper position (with respect to the text block of the nameplate). If an MCB, after it has triggered, cannot be switched on again off-handedly, the triggering is probably caused by overload.

If the MCB trips again immediately when trying to reclose (let a short period of time elapse), a complete short-circuit, or as the case may be, earth connection can be assumed.

Do not try and continuously re-close an existing short circuit or earth fault. The MCB even trips under overload, or short-circuit or earth fault conditions, even if the operating lever is maintained in the ON position by force (trip-free mechanism).

Cleaning the device

MCBs soiled by installation work should be cleaned with a dry, or, if necessary, a damp and soapy cloth. Never use caustic agents or dissolvents.

Maintenance

STOTZ MCBs are maintenance-free.

Opening the device will lead to a loss of warranty.

Connection:

For connection cross sections, see page 7.

Feeder optional, top or bottom, terminal designation according to EN 50 005.

For wiring diagrams, see picture to the right.

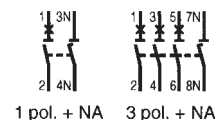
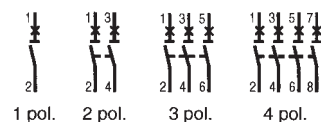

2CDC 022 153 F0003

Additional devices

Mounting additional devices

Additional devices are always fitted from the right hand side:

- signal contact/auxiliary switch S2C-S/H6R for MCBs and RCCBs
- auxiliary switch S2C-H6R for MCBs
- shunt release S2C-A for MCB

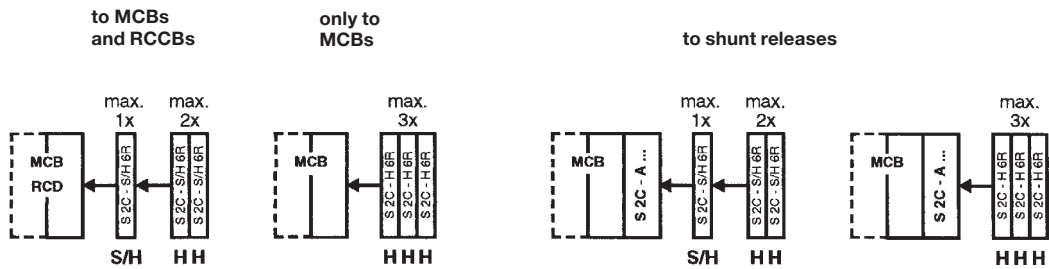

S function signal contact
H function auxiliary switch

2CDC 092 154 F0003

1. Signal contact and auxiliary switches

Retrofittable to the right side of circuit-breakers or shunt releases without extra installation devices.

1.1 Universal signal contact/ auxiliary switch type S2C-S/H6R

Description

S2 – serial code:

S 2 C - S / H 6 R

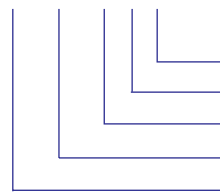

- R** = right side-mounted
- 6** = change over
- H** = auxiliary switch
- S** = signal contact
- C** = compatible to pro M compact

S2C-S/H6R is a universal device complementing the range of pro M compact, which is supplied to offer signal contact functionality, or the auxiliary switch can be activated, all you need is a screwdriver. The universal switch can be with MCBs and RCCBs. Up to three S2C-H6R can be mounted (one signal contact max. fitted to MCB or RCCB). Both the switchgear and the S2C-S/H6R must be in the ON end position to ensure that the coupling is correct.

Function of the signal contact S

Signal is transmitted only if caused by fault-tripping of the circuit-breaker, but not if the switch has been switched on or off manually. Press the orange reset button to acknowledge the has-tripped signal.

Function of the auxiliary switch H

The switch always indicates the switching position of the MCB, irrespective of whether the switching position is attributable to manual operation or fault tripping.

Functionality selection

To select either the signal contact function S or the auxiliary switch H, use a screwdriver and adjust to position S, or as the case may be, H at the side of the device.

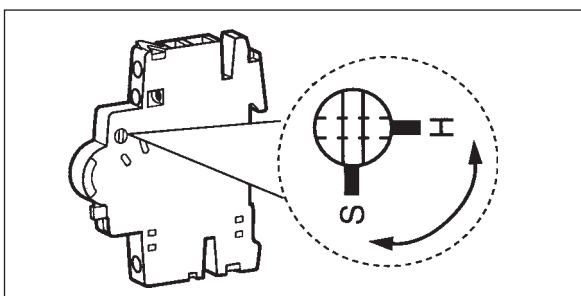

SK 0170 Z 02

Installation:

1. Mounting one S2C-S/H6R

→ RCCB or MCB must be in the ON position → remove coupling cover on the right side of the MCB/RCCB → signal contact/auxiliary switch in ON position → if fitted to MCB, remove bottom (RCD), if fitted to RCCB middle (MCB) coupling pin → plug devices together.

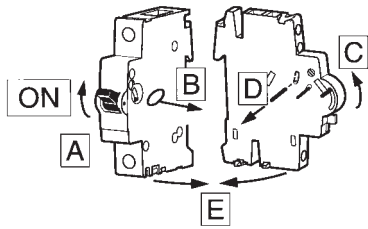

SK 0287 Z 02

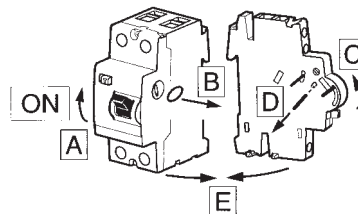

SK 0288 Z 02

2. Mounting more than one S2C-S/H6R

Up to three S2C-H6R can be mounted.

Note: one signal contact max. fitted at first to MCB or RCCB

If fitted to an MCB, remove the bottom coupling pin (RCD), if fitted to an RCCB, remove the middle coupling pin (MCB), switch all signal contact/ auxiliary switches to the end position ON, plug them together and carry through a function control test.

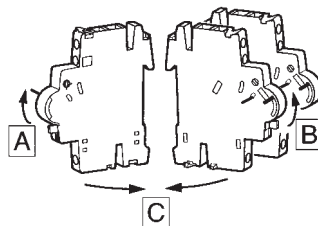

SK 0285 Z 02

Function control test:

After all signal contacts/auxiliary switches or auxiliary switches have been mounted, use the upper coupling pin to switch on the devices (ON position). If the lower (for RCD) or, as the case may be, the middle (for MCB) coupling pin is operated, all devices must trip.

Now combination with MCB/RCCB:

RCCB or MCB must be in the ON position → remove coupling cover on the right side of the MCB/RCCB → signal contact/auxiliary switch in ON position → if fitted to MCB, remove bottom (RCD), if fitted to RCCB middle (MCB) coupling pin → plug devices together.

Test functions of the signal contact

in ON and OFF position after hand operation

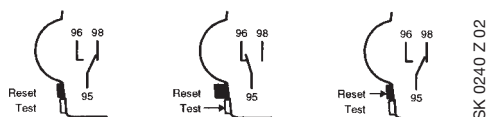

SK 0240 Z 02

Test functions of the auxiliary switch

in ON position

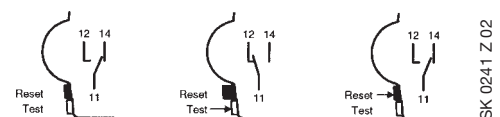

SK 0241 Z 02

in ON position after tripping

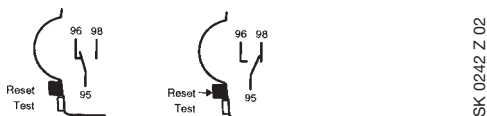

SK 0242 Z 02

in OFF position

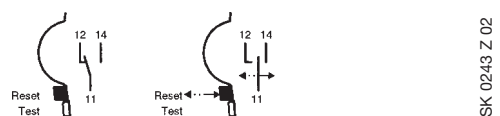

SK 0243 Z 02

Technical Data

Signal contact/auxiliary switch S2C-S/H6R and auxiliary switch S2C – H6R according to EN 62019

AC 14	U _e	400 V	230 V
	I _e	1 A	2 A
DC 12	U _e	220 V	110 V
	I _e	1 A	1.5 A
DC 13	U _e	60 V	24 V
	I _e	1.5 A	4 A

rated current I _{th} :	10 A
min. rated voltage U _{Bmin} :	24 V ~, 24 V...
min. rated operational current:	5 VA ①
short-circuit withstand capacity:	230 V~ 1000 A with S 201 K 4
insulation coordination:	according to DIN VDE 0110 Parts 1 and 2
– overvoltage category:	III
– surge voltage:	4 kV (1.2/50 µs)
– pollution degree:	2
connection cross section:	0.75 ... 2.5 mm ² (up to 2 x 1.5 mm ²)
tightening torque:	1.2 Nm max.
contact stability in vibration test according to DIN IEC 68-2-6-:	5 g, 20 sweep cycles 5 ... 150 ... 5 Hz at 24 VAC/DC, 5 mA automatic reclosing < 10 ms
mech. service life:	10 000 operations

① The minimum rated operational current value applies in the case of operation and environmental conditions according to EN 60 204-1/1998 and EN 60 439-1/2000 if installed indoors and in clean ambient air: 24 VAC/DC, 5 mA (AC-12, DC-12)

1.2 Auxiliary switch type S2C-H6R

Description

The simple auxiliary switch without test functionality is appropriate for applications where it is only necessary to indicate the contact position of the circuit-breaker.

Up to three S2C-H6R can be butt-mounted, including combinations with the signal contact/auxiliary switch SC2-S/H6R.

Installation and technical data

the same as for signal contact/auxiliary switch SC2-S/H6R, see preceding page and above.

Installation and technical data

the same as for signal contact/auxiliary switch SC2-S/H6R, see preceding page and above.

2. Shunt trip S2C-A

Description

For distance tripping of the MCB. The shunt release has a relay coil with an integrated contact which disconnects the coil and the coil voltage if the MCB trips, this prevents the flow of current in the case of sustained coil voltage.

Technical data

type:	S2C - A1	S2C - A2
service voltage:	12 ... 60 V	110 ... 415 VAC and 110 ... 250 VDC

STOTZ-Shunt trip with automatic disconnecting within 10 milliseconds U_B = U_n + 10 – 30 %

	U _B	I _{Bmax}		U _B	I _{Bmax}
S2C-A1	12 VDC	2.2 A	S2C-A2	110 VDC	0.35 A
	12 VAC	2.5 A		110 VAC	0.5 A
	24 VDC	4.5 A		220 VDC	1.1 A
	24 VAC	5 A		230 VAC	1.0 A
	60 VDC	14 A		415 VAC	2.7 A
	60 VAC	8.8 A			

U_B = operating voltage



I_{Bmax} = operating current

Description

Residual-current protective devices have a balance or, as the case may be, differential current transformer as measuring device that is connected with permanent magnet trip via the secondary winding. Residual-current protective devices cover a.c. fault current and pulsating d.c. fault current and are insensitive to current rushes up to 250 A, selective and short-time delayed tripping types up to 3,000 A). Pulse shape 8/20 according to DIN VDE 0432 Part 2.

STOTZ residual-current protective devices are surge-proof and thus insensitive to transient leakage current to earth, as may occur e.g. when switching fluorescent lamps, X-ray apparatus, IT systems and also thyristor control. (The value of the surge strength is indicated in the technical data information regarding the switching variants).

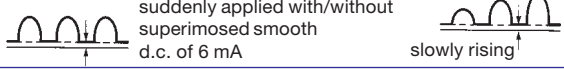
Protection through RCD of types AC, A and B according to IEC 755

form of residual current		correct functioning of RCD ●		
		a.c.- sensitive type AC	pulsating current-sensitive type A	d.c.-sensitive type B
sinusoidal a.c.		● F 200 AC	● F 200	●
pulsating d.c.			●	●
smooth d.c.				●

Selective RCCB F 200S

Is installed centrally and operates on a time-selective basis with respect to more sensitive downstream residual-current devices. The result is a high degree of service security, as in the case of a fault, only the circuit affected will be switched off. Due to their surge strength of up to 5,000 A/3,000 A, nuisance tripping of STOTZ main RCCBs caused by remote strike is ruled out. They are therefore the perfect choice for the connection of freezers and agricultural applications (e.g. fans in intensive livestock husbandry) according to DIN VDE 0100 Part 705.

Short-time delayed RCCBs F 200 R

are RCCBs with high surge strength needed where apparatus causes high leakage currents when switched on or off (e.g. lighting circuits with ballast, long lines).

Application





To obtain a better level of security in all wiring systems, as well as in supply areas with respect to which codes of practice recommend or require the use of residual-current protective devices.

Tasks

Protection against electric shock

Measures for the protection against electric shock as provided for in DIN VDE 0100 Part 410. These measures are:

- Protection from indirect touch – as fault protection through disconnection of circuit in the case of excessive touch voltage caused by short circuit to exposed conductive part.
- Protection from direct touch – as additional protection through disconnection when conductive parts are touched. Dangerous leakage current is switched off within the shortest possible time if the rated residual current of the circuit-breakers is $I_{\Delta n} \leq 30$ mA, in the case of people protector FS 201 $I_{\Delta n} \leq 10$ mA.
- Protection against fire – protection against fire ignited by electricity if the nominal residual current of the circuit-breaker is $I_{\Delta n} \leq 300$ mA.

Technical data	F 200	F 200 AC	F 200 R short time delayed	F 204 S selective	FS 201 RCBO
specifications:	DIN VDE 0664 Part 11, EN 61008-2-1				DIN VDE 0664 Part 21 and EN 61009/IEC 61009
No. of poles:	2-pole 4-pole	2-pole 4-pole	2-pole 4-pole	4-pole	
tripping characteristics:	-				B and C acc. to DIN VDE 0641 and EN 60898; K acc. to DIN VDE 0660 and EN 60947
rated current I_n :	16, 25, 40, 63 A	25, 40, 63 A		25, 40, 63 A	40 A, 63 A 6 to 32 (40) A
rated residual current $I_{\Delta n}$:	10, 30, 300 and 500 mA	30, 100 and 300 mA	30 mA	300 mA	10 mA, 30 mA, 300 mA
tripping range at  at 	0.50 ... 1.0 · $I_{\Delta n}$ 0.11 ... 1.4 · $I_{\Delta n}$				
tripping time  at 1 · $I_{\Delta n}$: at 2 · $I_{\Delta n}$: at 5 · $I_{\Delta n}$: at 500 A:	≤ 300 ms ≤ 40 ms	≤ 300 ms ≤ 40 ms	120 ... 300 ms 50 ... 150 ms 20 ... 40 ms	150 ... 500 ms 60 ... 200 ms 40 ... 150 ms 40 ... 150 ms	≤ 300 ms ≤ 40 ms
tripping time  at 1 · 1,4 $I_{\Delta n}$: at 5 · 1,4 $I_{\Delta n}$:	≤ 300 ms ≤ 40 ms	- -	≤ 300 ms ≤ 40 ms	≤ 300 ms ≤ 50 ... 150 ms	≤ 300 ms ≤ 40 ms
rated switching capacity:	-			-	6 kA, φ 0,7
surge strength (impulse waveshape 8/20):	250 A		3000 A	5000 A	250 A
short-circuit withstand capacity:	10.000 A, in connection with an upstream fuse gL 100 A or the STOTZ selective main circuit-breaker S 700-E 100 A			10.000 A, in connection with an upstream fuse gL 100 A or the selective main circuit-breaker S 700-E 100 A	
rated voltage U_n :	2-pole: 230 V ~ 4-pole: 230/400 V ~		230/400 V ~		2-pole: 230 V ~
max. operating voltage U_{Bmax} :	$U_n + 10\%$				
operative range of test equipment U_T :	100 V ~ to 264 V ~				100 V ~ to 264 V ~ 100 V ~ to 264 V ~
insulation coordination according to DIN VDE 0110 Part 1 and 2 - overvoltage category: - pollution degree: - surge voltage U_{imp} (1,2/50): - power-frequency withstand voltage (50/60 Hz):	III, disconnector abilities 2 4 kV 2.5 kV				
frequency:	50/60 Hz				50/60 Hz
housing:	moulding grey				moulding grey
operating lever/test button:	blue				black/blue
degree of protection:	IP 20; in the distribution board IP 40; in moulded-plastic casing IP 55 (see accessories)				
dimensions:	see dimension drawings				
connection cross section:	1 to 16 mm ² for finely-stranded to massive conductors for I_n to 40 A, 1 to 25 mm ² for I_n 63 A				1 to 16 mm ²
service life:	> 5.000 switches				
climatic resistance according to DIN IEC 68 Part 2-30: (RH = rel. humidity)	damp heat, cyclic (55 °C/28 cycles)				damp heat: 28 cycl. 55/95 ... 100 (°C/RH) alternating climate: 25/95 - 40/93 (°C/RH) constant climate: 23/83, 40/93, 55/95 ... 100 (°C/RH)
ambient temperature:	$T_{max.} + 55\text{ °C}$ $T_{min.} - 25\text{ °C}$				
vibration resistance according to:	DIN VDE 0664 Part 1/10.85 and EN 61008				DIN VDE 0664 Part 2/10.85 and EN 61009
terminals:	bi-directional cylinder-lift terminal				
trip-free mechanism:	yes				
connection:	individually or collectively via a busbar				
supplementary devices:	type S2C-S/HR s. pagee 17				in preparation

Installation and operation instructions

Installation

Can be installed in any mounting position due to snap-on fixing to DIN rails EN 50 022, 35 mm width.

- A** If RCD F 200/FS 201 is installed without cross-wiring, hinge the upper part into the DIN rail and push to let the lower part of the device snap into place (1). The device is released in the reverse order, after the quick fastener has been removed with a screw driver (2).
- B** To release RCD F 200/FS 201 that are cross-wired with **System pro M compact** busbars, first remove the clamping screws. Then, pull the lower part of the F 200/FS 201 forwards (1) and lift it straight up (1a), then, the quick fastener will recede (1b).
- C** The busbar is deallocated and the RCD F 200/FS 201 can be pulled out by lifting the device forwards (2).
- D** The cross-wiring is re-inserted in the reverse order. First, open the clamping screws and pull out the quick fastener **until it locks into place for the first time** (3). Then, take the RCD F 200/FS 201 and insert it with the rear terminal side onto the pins of the **System pro M compact** busbar (4), turn it into the direction of the DIN rail (4a) and shift it vertically downwards (4b), to let the quick fastener snap back into place (4c).

Attention: Do not forget to re-tighten the clamping screws.

A Assembly,
disassembly
without
pro M compact
cross wiring

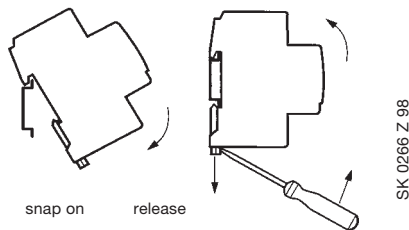

SK 0266 Z 98

B Detaching when
pro M compact
cross wiring
remains in place

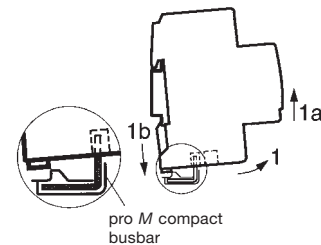

SK 0267 Z 98

C Removal when
pro M compact
cross wiring
remains in place

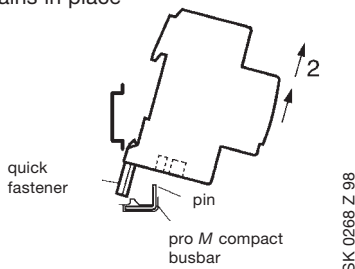

SK 0268 Z 98

D Insertion when
pro M compact
cross wiring
remains in place

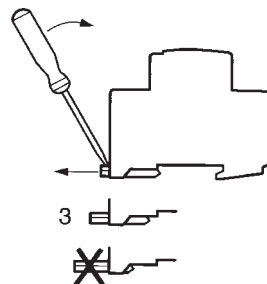

SK 0167 Z 99

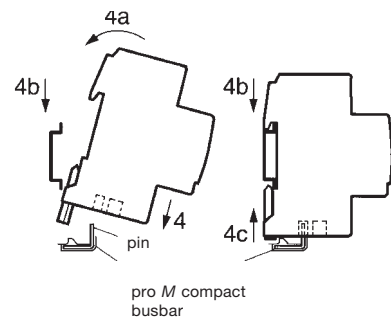

SK 0269 Z 98

Connection

Feeder optional, top or bottom. Ensure that conductors are connected correctly and firmly.

If the 4-pole RCCB is operated as a 2-pole RCCB, use terminals 5 and 7 or, as the case may be, 6 and 8 to make sure that the test button function of the RCCB is working. In the case of a three-phase system with $U_n = 127/230$ V (without neutral N), terminals 4 and 8 must be bridged.

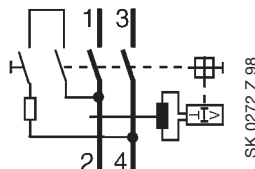

SK 0272 Z 98

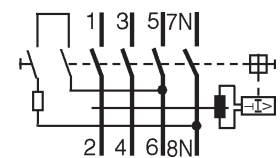

SK 0012 Z 96

Operation

F 200/FS 201 is switched ON or OFF with the blue operating lever.

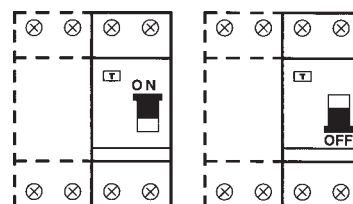

2CDC 032 138
F0203

Operating test

To test proper functioning, press the blue test button when the device is switched ON, the RCCB must trip immediately (the knob jumps into the „0“ switching position).

It is necessary to test the RCD halfyearly, if no other regional or user specified additional test are required.

Test of protective measure

Except for the operating test, the effectiveness of the protection provided within the installation must be tested according to the applicable codes of practice. For RCD protection, the maximum permissible earthing resistance values are as follows:

max. touch voltage U_L	max. earthing resistance at nominal residual current				
	10 mA	30 mA	100 mA	300 mA	500 mA
25 V	2500 Ω	833 Ω	250 Ω	83 Ω	50 Ω
50 V	5000 Ω	1666 Ω	500 Ω	166 Ω	100 Ω

Malfunctioning

The high-quality STOTZ residual-current-operated circuit-breakers are thoroughly adjusted and tested in our works. Where damage occurs (caused e.g. by transport, storage, etc.) no repair work must be undertaken. If the device responds immediately after putting the RCCB into operation, check the downstream active circuit and any connected current-consuming apparatus for earth fault current. Remove insulation faults or connections between the neutral conductor and the protective conductor existing in load circuit. Where the RCCB does not trip in the first operating test after pressing the test button, check first whether the test circuit is connected correctly.

Where none of the above causes apply, or should the operating test be completed unsuccessfully, the RCCB must be replaced.

Opening the device will lead to a loss of warranty.

Examples for the protection against electric shock

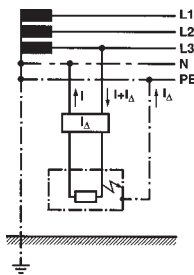

SK 0038 Z 94

TN-S system (protective multiple earthing)
separate neutral and protective conductors throughout the network

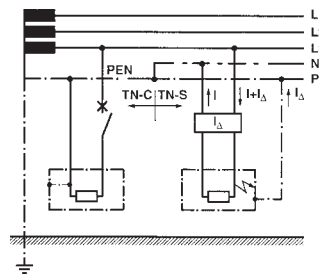

SK 0005 Z 97

TN-C-S system
neutral and protective conductor (PEN) combined in one part of the network.

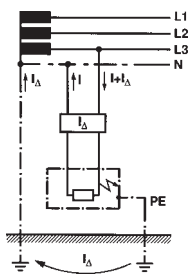

SK 0040 Z 94

TT system

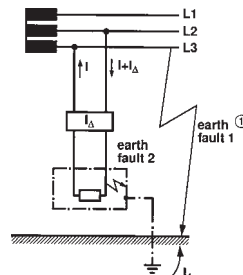

① only indicated by line isolation monitor

SK 0017 Z 95

IT system

The residual-current-operated circuit-breaker trips if a double fault occurs, as e.g. is indicated as fault 1 and fault 2 above.

Explanation of type codes

- L1, L2, L3 „line“ phase conductor
- PE „protection earth“
- N „neutral“
- PEN PE and N combined
- T „terre“ direct bond to earth

- I „insulation“
- C „combined“ PE and N (PEN)
- S „separated“ PE and N
- „...“ terms used in international IEC standard

Description

The newly developed **pro M compact** cross wiring busbar system includes everything that is needed for secure and economic connections of distribution build-in devices of the series S 200 and F 200.

The optimised quick fastener of the S 200 series, F 200, when used together with the **System pro M compact** cross wiring busbars, makes removing and inserting devices a quick and easy job, and the cross wiring of other devices remains in place, at that.

Busbars are supplied ready-to-use and in standard lengths, time-consuming cutting to length or end caps are no longer required.

MCBs and RCCBs of the customary **System pro M** technology can also be easily cross-wired with the new **System pro M compact** busbars.

Technical data

specifications:	VDE 0660 Part 500, DIN EN 60439-1: 1994	test surge voltage: (1,2/50)	6,2 kV
busbar material:	SF-Cu F 24	short-circuit withstand capacity:	25 kA
insulating profile material:	plastic, temperature resistant ≥ 90 °C flame-retardant, self-extinguishing dioxine- and halogene-free	climatic resistance:	constant climate L23/83; 40/92 55/20 according to DIN 50 015 humid heat, 28 cycles (\geq IEC 68 Part 2 - 30)
busbar cross section:	10 mm ²	insulation coordination:	acc. to VDE 0110 Part 1 April 1997 (IEC 664)
max. operating voltage:	440 V	- overvoltage category:	III
rated surge voltage:	4 kV	- pollution degree:	2

Load capability depending on the feed point

bar cross section	10 mm ²	16 mm ²
① max. busbar current I_S /phase	63 A	80 A
② max. current in branch I_E /phase	100 A	130 A*

* If the device is fed via the device terminal, ensure that - irrespective of the current carrying capacity (I_S) of the busbar - the following values are not exceeded:

For devices up to and including 40 A I_n max. 110 A and for 50/63 A I_n max. 140 A.

① incoming supply at the beginning of the busbar

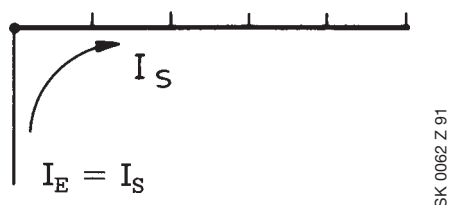

② incoming supply within the busbar or centre-fed

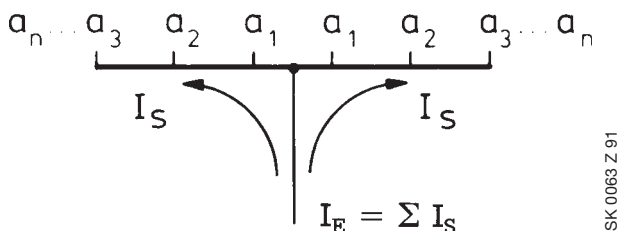

If the device is centre-fed (see picture to the right), ensure that the combined outgoing currents $a_1 \dots a_n$ per branch do not exceed the max. busbar current I_S /phase referred to above.

Dimensions

measurements in mm

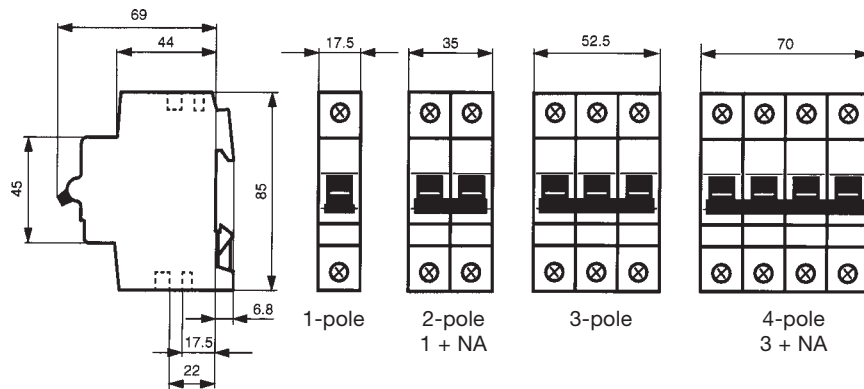

S 201, S 202, S 203, S 204

SK 0136 Z 01

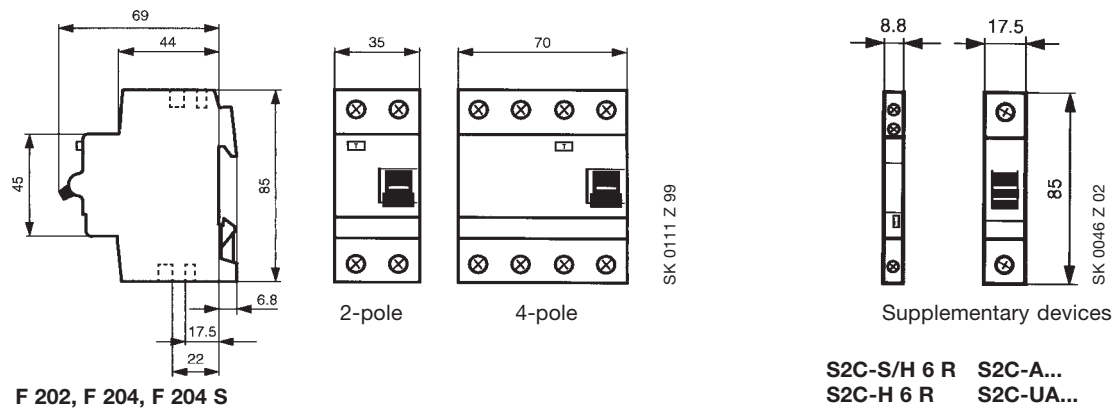

F 202, F 204, F 204 S

**S2C-S/H 6 R S2C-A...
S2C-H 6 R S2C-UA...**

SK 0111 Z 99

SK 0046 Z 02

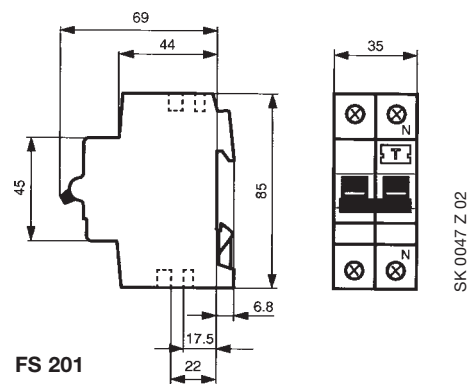

FS 201

SK 0047 Z 02

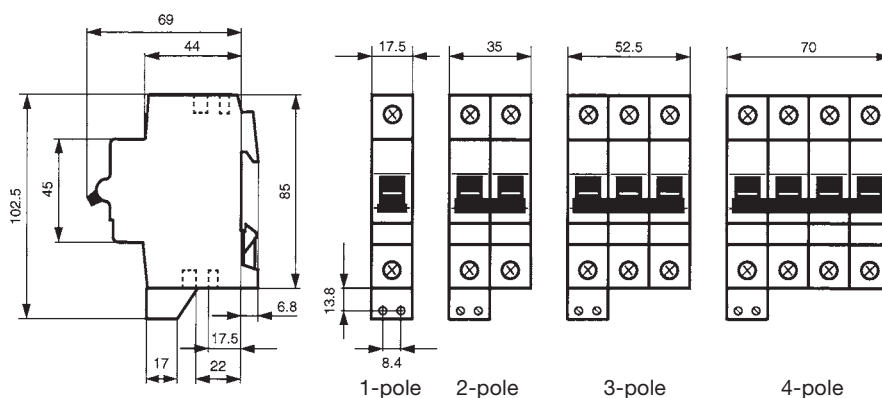

S 201 H, S 202 H, S 203 H, S 204 H

SK 0058 Z 01

Accessories Dimensions

Terminal covers

measurements in mm

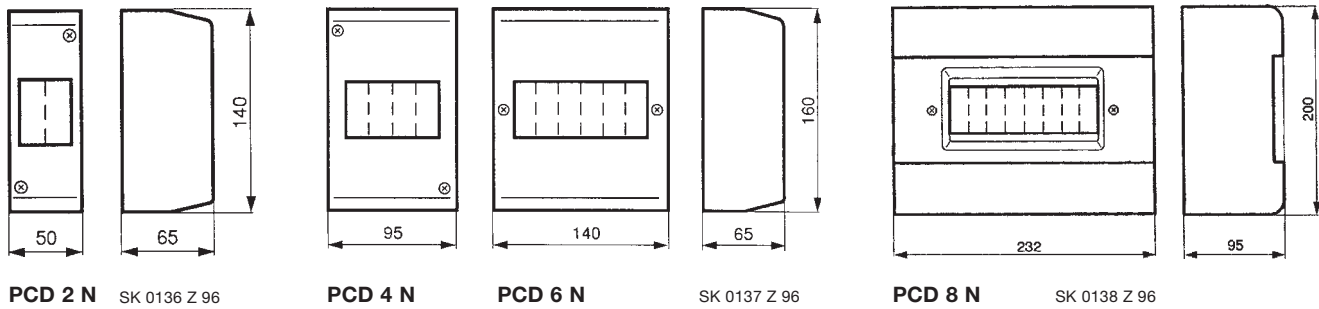

Enclosure of moulded-plastic

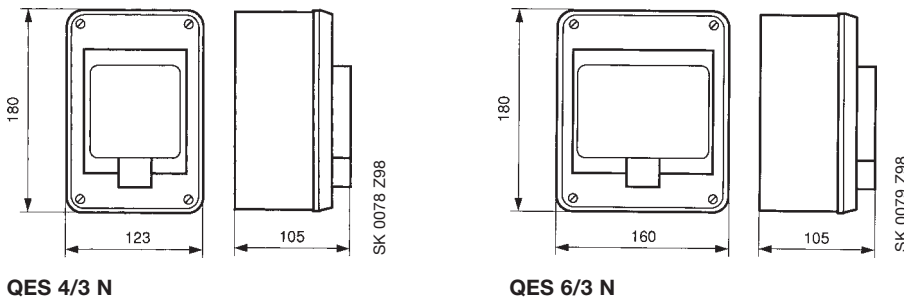

Flush frame

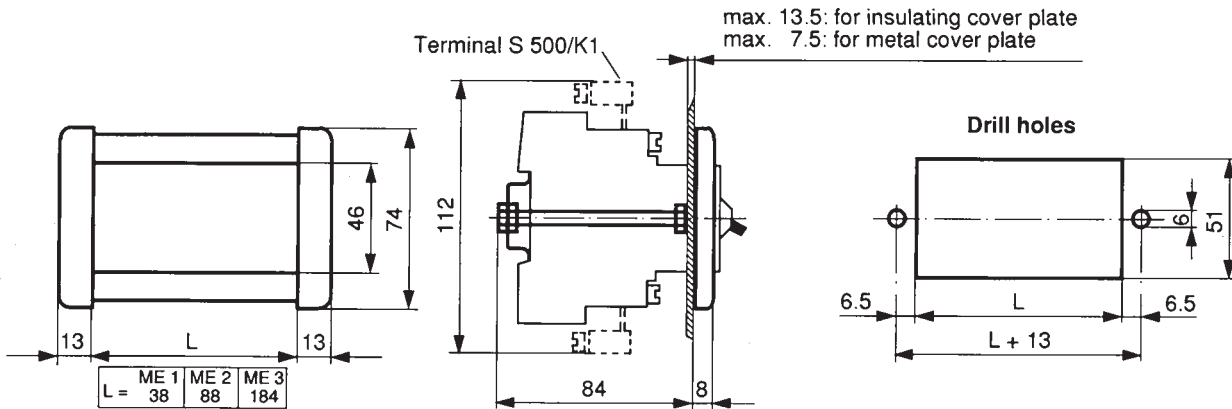

type	dim. L	max. No. of modules (1 module = 17.5 mm)
S 500 - ME 1	38 mm	for 2 Module
S 500 - ME 2	88 mm	for 5 Module
S 500 - ME 3	184 mm	for 10 Module

Mounting rails

① In the case of DSW 1,
the drill holes
are vertical

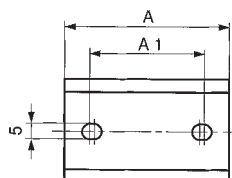

name	A	A1
DSW	17.5	15
DSW 2	35	20
DSW 3	52.5	37.5
DSW 4	70	55
DSW 6	105	90

SK 0131 Z 94

Dimensions

measurements in mm

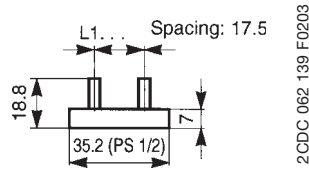

PS 1/2

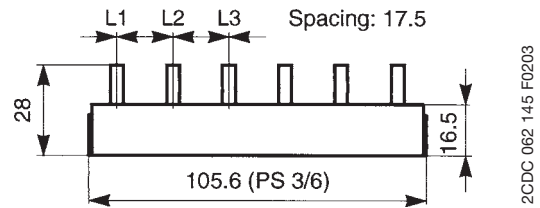

PS 3/6

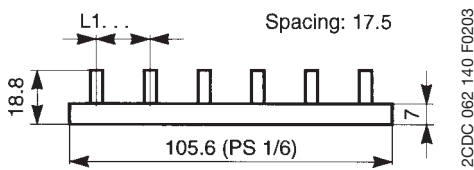

PS 1/6

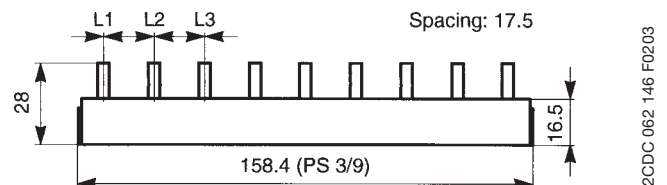

PS 3/9

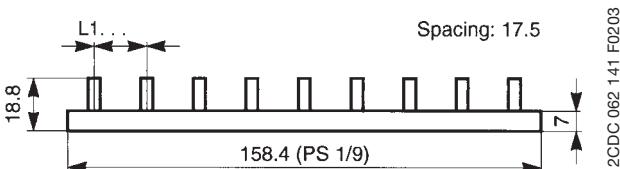

PS 1/9

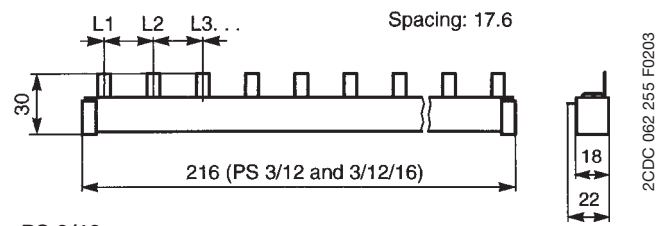

PS 3/12

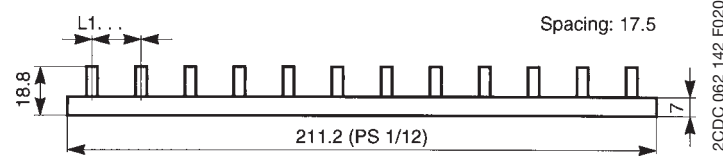

PS 1/12

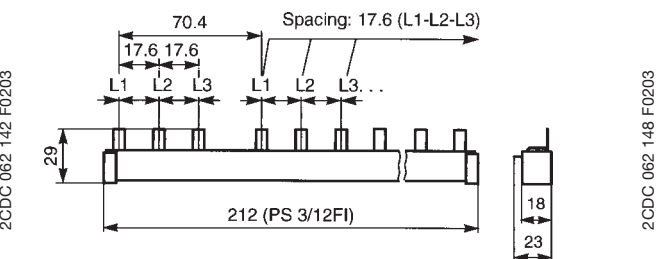

PS 3/12 FI

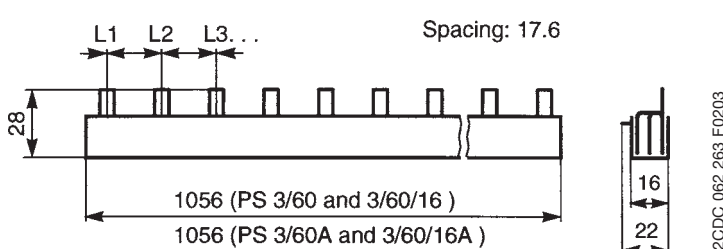

PS 3/60

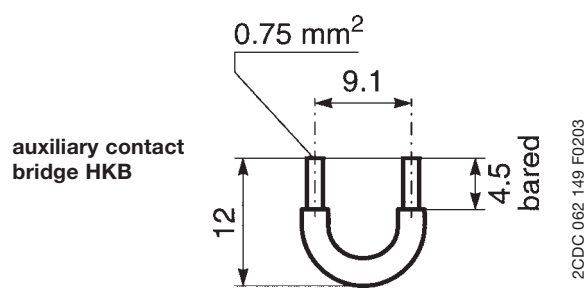

**auxiliary contact
bridge HKB**

Dimensions

measurements in mm

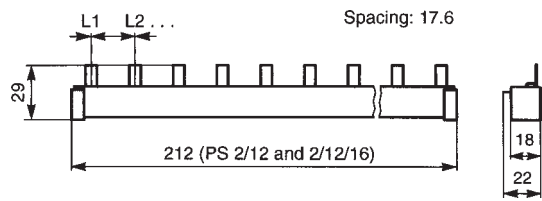

PS 2/12

2CDC 062 251 F0203

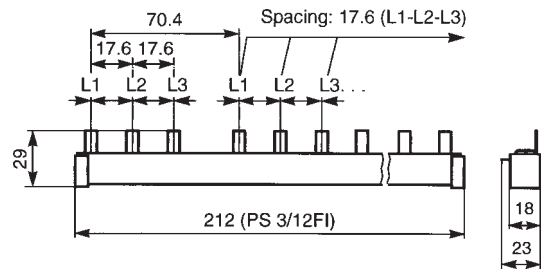

PS 3/12 FI H

2CDC 062 148 F0203

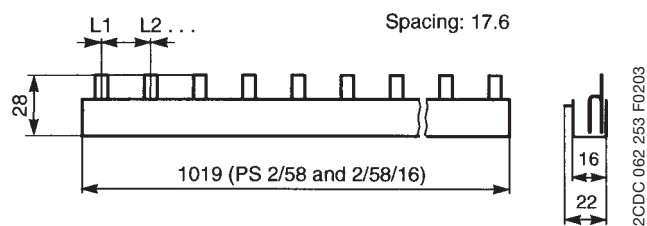

PS 2/58

2CDC 062 253 F0203

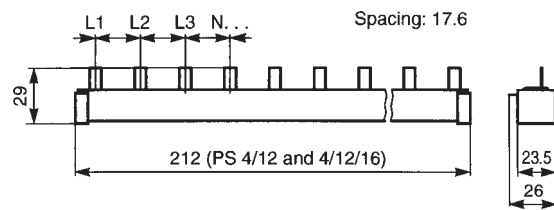

PS 4/12

2CDC 062 265 F0203

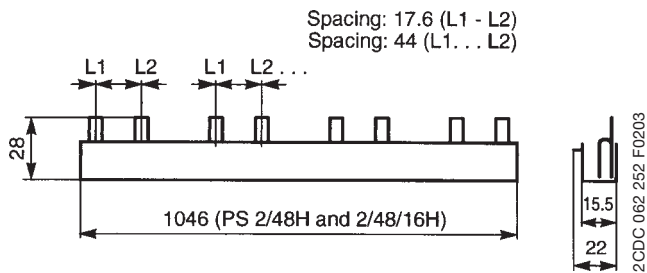

PS 2/48

2CDC 062 252 F0203

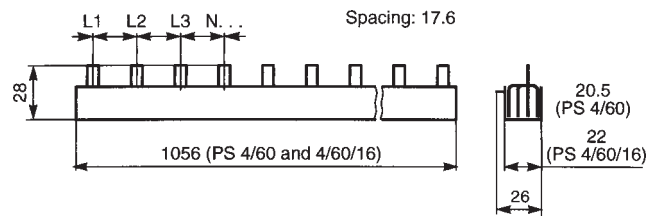

PS 4/60

2CDC 062 269 F0203

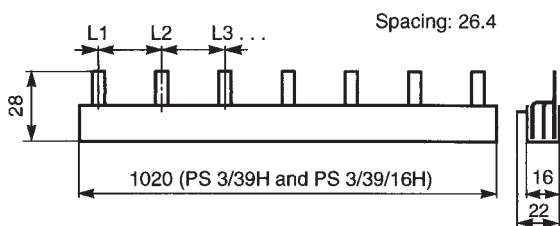

PS 3/39 H

2CDC 062 260 F0203

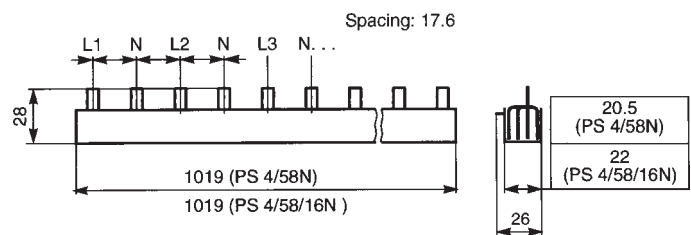

PS 4/58 N

2CDC 062 267 F0203

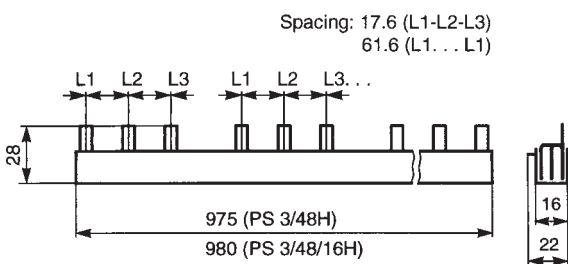

PS 3/48 H

2CDC 062 261 F0203

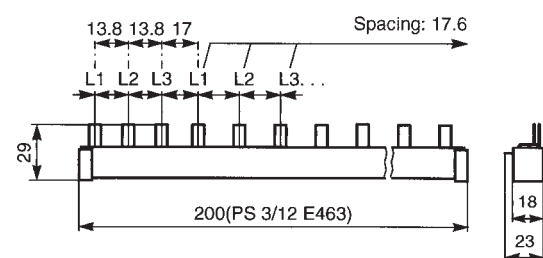

PS 3/12 E 463

2CDC 062 143 F0203

D

6000
3



SK 018 B 01



SK 019 B 01



SK 020 B 019



SK 030 B 01

Selection table

No. of poles	rated current I_n , A	order details		bbn 40 16779 EAN	price 1 piece €	price group	w'ght 1 pc. kg	pack. unit pc.
		type code	order code					
1	0.5	S 201-D 0.5	2CDS 251 001 R0981	52993 8			0.125	10/40
	1	S 201-D 1	2CDS 251 001 R0011	52994 5				
	1.6	S 201-D 1.6	2CDS 251 001 R0971	52995 2				
	2	S 201-D 2	2CDS 251 001 R0021	52996 9				
	3	S 201-D 3	2CDS 251 001 R0031	52997 6				
	4	S 201-D 4	2CDS 251 001 R0041	52998 3				
	6	S 201-D 6	2CDS 251 001 R0061	52999 0				
	8	S 201-D 8	2CDS 251 001 R0081	53000 2				
	10	S 201-D 10	2CDS 251 001 R0101	53001 9				
	13	S 201-D 13	2CDS 251 001 R0131	53002 6				
	16	S 201-D 16	2CDS 251 001 R0161	53003 3				
	20 ①	S 201-D 20	2CDS 251 001 R0201	53004 0				
	25	S 201-D 25	2CDS 251 001 R0251	53005 7				
	32 ②	S 201-D 32	2CDS 251 001 R0321	53006 4				
	40 ③	S 201-D 40	2CDS 251 001 R0401	53007 1				
	50	S 201-D 50	2CDS 251 001 R0501	55199 1				
	63	S 201-D 63	2CDS 251 001 R0631	55200 4				
2	0.5	S 202-D 0.5	2CDS 252 001 R0981	53048 4			0.250	5/20
	1	S 202-D 1	2CDS 252 001 R0011	53049 1				
	1.6	S 202-D 1.6	2CDS 252 001 R0971	53050 7				
	2	S 202-D 2	2CDS 252 001 R0021	53051 4				
	3	S 202-D 3	2CDS 252 001 R0031	53052 1				
	4	S 202-D 4	2CDS 252 001 R0041	53053 8				
	6	S 202-D 6	2CDS 252 001 R0061	53054 5				
	8	S 202-D 8	2CDS 252 001 R0081	53055 2				
	10	S 202-D 10	2CDS 252 001 R0101	53058 3				
	13	S 202-D 13	2CDS 252 001 R0131	53060 6				
	16	S 202-D 16	2CDS 252 001 R0161	53061 3				
	20	S 202-D 20	2CDS 252 001 R0201	53063 7				
	25	S 202-D 25	2CDS 252 001 R0251	53064 4				
	32	S 202-D 32	2CDS 252 001 R0321	53065 1				
	40	S 202-D 40	2CDS 252 001 R0401	53066 8				
	50 ④	S 202-D 50	2CDS 252 001 R0501	55203 5				
	63	S 202-D 63	2CDS 252 001 R0631	55204 2				
3	0.5	S 203-D 0.5	2CDS 253 001 R0981	53081 1			0.375	3/12
	1	S 203-D 1	2CDS 253 001 R0011	53082 8				
	1.6	S 203-D 1.6	2CDS 253 001 R0971	53083 5				
	2	S 203-D 2	2CDS 253 001 R0021	53084 2				
	3	S 203-D 3	2CDS 253 001 R0031	53085 9				
	4	S 203-D 4	2CDS 253 001 R0041	53086 6				
	6	S 203-D 6	2CDS 253 001 R0061	53088 0				
	8	S 203-D 8	2CDS 253 001 R0081	53089 7				
	10	S 203-D 10	2CDS 253 001 R0101	53090 3				
	13	S 203-D 13	2CDS 253 001 R0131	53091 0				
	16	S 203-D 16	2CDS 253 001 R0161	53092 7				
	20 ①	S 203-D 20	2CDS 253 001 R0201	53093 4				
	25	S 203-D 25	2CDS 253 001 R0251	53094 1				
	32 ②	S 203-D 32	2CDS 253 001 R0321	53095 8				
	40 ③	S 203-D 40	2CDS 253 001 R0401	53096 5				
	50	S 203-D 50	2CDS 253 001 R0501	55205 9				
	63	S 203-D 63	2CDS 253 001 R0631	55206 6				
4	0.5	S 204-D 0.5	2CDS 254 001 R0981	53112 2			0.500	2
	1	S 204-D 1	2CDS 254 001 R0011	53113 9				
	1.6	S 204-D 1.6	2CDS 254 001 R0971	53114 6				
	2	S 204-D 2	2CDS 254 001 R0021	53115 3				
	3	S 204-D 3	2CDS 254 001 R0031	53116 0				
	4	S 204-D 4	2CDS 254 001 R0041	53117 7				
	6	S 204-D 6	2CDS 254 001 R0061	53118 4				
	8	S 204-D 8	2CDS 254 001 R0081	53119 1				
	10	S 204-D 10	2CDS 254 001 R0101	53120 7				
	13	S 204-D 13	2CDS 254 001 R0131	53121 4				
	16	S 204-D 16	2CDS 254 001 R0161	53122 1				
	20	S 204-D 20	2CDS 254 001 R0201	53123 8				
	25	S 204-D 25	2CDS 254 001 R0251	53129 0				
	32 ④	S 204-D 32	2CDS 254 001 R0321	53130 6				
	40	S 204-D 40	2CDS 254 001 R0401	53131 3				
	50	S 204-D 50	2CDS 254 001 R0501	55209 7				
	63	S 204-D 63	2CDS 254 001 R0631	55210 3				

① suitable for flow-type heaters 12 kW
② suitable for flow-type heaters 18 kW

③ suitable for flow-type heaters 21, 24 and 27 kW
④ U_{Bmax} 125 V ∴ with 2 poles connected in series

B

10000
S



SK 032 B 02

Selection table

No. of poles	rated current I_n A	order details		bbn 40 16779 EAN	price 1 piece €	price group	w'ght 1 pc. kg	pack. unit pc.	
		type code	order code						
1	6	S 201 M-B 6	2CDS 271 001 R0065	54942 4			0.125	10/40	
	10	S 201 M-B 10	2CDS 271 001 R0105	54943 1					
	13	S 201 M-B 13	2CDS 271 001 R0135	54944 8					
	16	S 201 M-B 16	2CDS 271 001 R0165	54945 5					
	20 ①	S 201 M-B 20	2CDS 271 001 R0205	54946 2					
	25	S 201 M-B 25	2CDS 271 001 R0255	54947 9					
	U_{Bmax} 440 V ~	32 ②	S 201 M-B 32	2CDS 271 001 R0325					54948 6
	60 V ∴	40 ③	S 201 M-B 40	2CDS 271 001 R0405					54949 3
	50	S 201 M-B 50	2CDS 271 001 R0505	54381 1					
	63	S 201 M-B 63	2CDS 271 001 R0635	54382 8					
2	6	S 202 M-B 6	2CDS 272 001 R0065	54958 5			0.250	5/20	
	10	S 202 M-B 10	2CDS 272 001 R0105	54959 2					
	13	S 202 M-B 13	2CDS 272 001 R0135	54960 8					
	16	S 202 M-B 16	2CDS 272 001 R0165	54961 5					
	20	S 202 M-B 20	2CDS 272 001 R0205	54962 2					
	25	S 202 M-B 25	2CDS 272 001 R0255	54963 9					
	U_{Bmax} 440 V ~	32	S 202 M-B 32	2CDS 272 001 R0325					54964 6
	125 V ∴	40	S 202 M-B 40	2CDS 272 001 R0405					54965 3
	50	S 202 M-B 50	2CDS 272 001 R0505	54385 9					
	④	63	S 202 M-B 63	2CDS 272 001 R0635					54386 6
3	6	S 203 M-B 6	2CDS 273 001 R0065	54966 0			0.375	3/12	
	10	S 203 M-B 10	2CDS 273 001 R0105	54967 7					
	13	S 203 M-B 13	2CDS 273 001 R0135	54968 4					
	16	S 203 M-B 16	2CDS 273 001 R0165	54969 1					
	20 ①	S 203 M-B 20	2CDS 273 001 R0205	54970 7					
	25	S 203 M-B 25	2CDS 273 001 R0255	54971 4					
	U_{Bmax} 440 V ~	32 ②	S 203 M-B 32	2CDS 273 001 R0325					54972 1
	40 ③	S 203 M-B 40	2CDS 273 001 R0405	54973 8					
	50	S 203 M-B 50	2CDS 273 001 R0505	54387 3					
	63	S 203 M-B 63	2CDS 273 001 R0635	54388 0					
4	6	S 204 M-B 6	2CDS 274 001 R0065	54982 0			0.500	2	
	10	S 204 M-B 10	2CDS 274 001 R0105	54983 7					
	13	S 204 M-B 13	2CDS 274 001 R0135	54984 4					
	16	S 204 M-B 16	2CDS 274 001 R0165	54985 1					
	20	S 204 M-B 20	2CDS 274 001 R0205	54986 8					
	25	S 204 M-B 25	2CDS 274 001 R0255	54987 5					
	U_{Bmax} 440 V ~	32	S 204 M-B 32	2CDS 274 001 R0325					54988 2
	125 V ∴	40	S 204 M-B 40	2CDS 274 001 R0405					54989 9
	50	S 204 M-B 50	2CDS 274 001 R0505	54391 0					
	④	63	S 204 M-B 63	2CDS 274 001 R0635					54392 7

① suitable for flow-type heaters 12 kW
② suitable for flow-type heaters 18 kW

③ suitable for flow-type heaters 21, 24 and 27 kW
④ U_{Bmax} 125 V ∴ with 2 poles connected in series

B

10000
3



SK 032 B 02

Selection table

No. of poles	rated current I_n A	order details	bbn 40 16779 EAN	price 1 piece €	price group	w'ght 1 pc. kg	pack. unit pc.
		type code	order code				

With disconnecting neutral NA

1 + NA	6	S 201 M-B 6 NA	2CDS 271 103 R0065	54950 9		0.250	50/40
	10	S 201 M-B 10 NA	2CDS 271 103 R0105	54951 6			
	13	S 201 M-B 13 NA	2CDS 271 103 R0135	54952 3			
	16	S 201 M-B 16 NA	2CDS 271 103 R0165	54953 0			
	20 ①	S 201 M-B 20 NA	2CDS 271 103 R0205	54954 7			
	25	S 201 M-B 25 NA	2CDS 271 103 R0255	54955 4			
	32 ②	S 201 M-B 32 NA	2CDS 271 103 R0325	54956 1			
	40 ③	S 201 M-B 40 NA	2CDS 271 103 R0405	54957 8			
	50	S 201 M-B 50 NA	2CDS 271 103 R0505	54383 5			
	63	S 201 M-B 63 NA	2CDS 271 103 R0635	54384 2			
3 + NA	6	S 203 M-B 6 NA	2CDS 273 103 R0065	54974 5		0.500	2/20
	10	S 203 M-B 10 NA	2CDS 273 103 R0105	54975 2			
	13	S 203 M-B 13 NA	2CDS 273 103 R0135	54976 9			
	16	S 203 M-B 16 NA	2CDS 273 103 R0165	54977 6			
	20 ①	S 203 M-B 20 NA	2CDS 273 103 R0205	54978 3			
	25	S 203 M-B 25 NA	2CDS 273 103 R0255	54979 0			
	32 ②	S 203 M-B 32 NA	2CDS 273 103 R0325	54980 6			
	40 ③	S 203 M-B 40 NA	2CDS 273 103 R0405	54981 3			
	50	S 203 M-B 50 NA	2CDS 273 103 R0505	54389 7			
	63	S 203 M-B 63 NA	2CDS 273 103 R0635	54390 3			

① suitable for flow-type heaters 12 kW
② suitable for flow-type heaters 18 kW

③ suitable for flow-type heaters 21, 24 and 27 kW

C

10000
3



SK 044 B 02



SK 045 B 02



SK 046 B 02

Selection table

No. of poles	rated current I _n A	order details		bbn 40 16779 EAN	price 1 piece €	price group	w'ght 1 pc. kg	pack. unit pc.
		type code	order code					
1	0.5	S 201 M-C 0.5	2CDS 271 001 R0984	54990 5			0.125	10/40
	1	S 201 M-C 1	2CDS 271 001 R0014	54992 9				
	1.6	S 201 M-C 1.6	2CDS 271 001 R0974	54991 2				
	2	S 201 M-C 2	2CDS 271 001 R0024	54993 6				
	3	S 201 M-C 3	2CDS 271 001 R0034	54994 3				
	4	S 201 M-C 4	2CDS 271 001 R0044	54995 0				
	6	S 201 M-C 6	2CDS 271 001 R0064	54996 7				
	8	S 201 M-C 8	2CDS 271 001 R0084	54997 4				
	10	S 201 M-C 10	2CDS 271 001 R0104	54998 1				
	13	S 201 M-C 13	2CDS 271 001 R0134	54999 8				
	16	S 201 M-C 16	2CDS 271 001 R0164	55000 0				
	20 ①	S 201 M-C 20	2CDS 271 001 R0204	55001 7				
	25	S 201 M-C 25	2CDS 271 001 R0254	55002 4				
	32 ②	S 201 M-C 32	2CDS 271 001 R0324	55003 1				
	40 ③	S 201 M-C 40	2CDS 271 001 R0404	55004 8				
	50	S 201 M-C 50	2CDS 271 001 R0504	54393 4				
	63	S 201 M-C 63	2CDS 271 001 R0634	54394 1				
U _{Bmax} 440 V ~ 60 V ∴								
2	0.5	S 202 M-C 0.5	2CDS 272 001 R0984	55020 8			0.250	5/20
	1	S 202 M-C 1	2CDS 272 001 R0014	55022 2				
	1.6	S 202 M-C 1.6	2CDS 272 001 R0974	55021 5				
	2	S 202 M-C 2	2CDS 272 001 R0024	55023 9				
	3	S 202 M-C 3	2CDS 272 001 R0034	55024 6				
	4	S 202 M-C 4	2CDS 272 001 R0044	55025 3				
	6	S 202 M-C 6	2CDS 272 001 R0064	55026 0				
	8	S 202 M-C 8	2CDS 272 001 R0084	55027 7				
	10	S 202 M-C 10	2CDS 272 001 R0104	55028 4				
	13	S 202 M-C 13	2CDS 272 001 R0134	55029 1				
	16	S 202 M-C 16	2CDS 272 001 R0164	55030 7				
	20	S 202 M-C 20	2CDS 272 001 R0204	55031 4				
	25	S 202 M-C 25	2CDS 272 001 R0254	55032 1				
	32	S 202 M-C 32	2CDS 272 001 R0324	55033 8				
	40	S 202 M-C 40	2CDS 272 001 R0404	55034 5				
	50	S 202 M-C 50	2CDS 272 001 R0504	54397 2				
	63	S 202 M-C 63	2CDS 272 001 R0634	54398 9				
U _{Bmax} 440 V ~ 125 V ∴ ④								
3	0.5	S 203 M-C 0.5	2CDS 273 001 R0984	55035 2			0.375	3/12
	1	S 203 M-C 1	2CDS 273 001 R0014	55037 6				
	1.6	S 203 M-C 1.6	2CDS 273 001 R0974	55036 9				
	2	S 203 M-C 2	2CDS 273 001 R0024	55038 3				
	3	S 203 M-C 3	2CDS 273 001 R0034	55039 0				
	4	S 203 M-C 4	2CDS 273 001 R0044	55040 6				
	6	S 203 M-C 6	2CDS 273 001 R0064	55041 3				
	8	S 203 M-C 8	2CDS 273 001 R0084	55042 0				
	10	S 203 M-C 10	2CDS 273 001 R0104	55043 7				
	13	S 203 M-C 13	2CDS 273 001 R0134	55044 4				
	16	S 203 M-C 16	2CDS 273 001 R0164	55045 1				
	20 ①	S 203 M-C 20	2CDS 273 001 R0204	55046 8				
	25	S 203 M-C 25	2CDS 273 001 R0254	55047 5				
	32 ②	S 203 M-C 32	2CDS 273 001 R0324	55048 2				
	40 ③	S 203 M-C 40	2CDS 273 001 R0404	55049 9				
	50	S 203 M-C 50	2CDS 273 001 R0504	54399 6				
	63	S 203 M-C 63	2CDS 273 001 R0634	54400 9				
U _{Bmax} 440 V ~								
4	0.5	S 204 M-C 0.5	2CDS 274 001 R0984	55065 9			0.500	2
	1	S 204 M-C 1	2CDS 274 001 R0014	55067 3				
	1.6	S 204 M-C 1.6	2CDS 274 001 R0974	55066 6				
	2	S 204 M-C 2	2CDS 274 001 R0024	55068 0				
	3	S 204 M-C 3	2CDS 274 001 R0034	55069 7				
	4	S 204 M-C 4	2CDS 274 001 R0044	55070 3				
	6	S 204 M-C 6	2CDS 274 001 R0064	55071 0				
	8	S 204 M-C 8	2CDS 274 001 R0084	55072 7				
	10	S 204 M-C 10	2CDS 274 001 R0104	55073 4				
	13	S 204 M-C 13	2CDS 274 001 R0134	55074 1				
	16	S 204 M-C 16	2CDS 274 001 R0164	55075 8				
	20	S 204 M-C 20	2CDS 274 001 R0204	55076 5				
	25	S 204 M-C 25	2CDS 274 001 R0254	55077 2				
	32	S 204 M-C 32	2CDS 274 001 R0324	55078 9				
	40	S 204 M-C 40	2CDS 274 001 R0404	55079 6				
	50	S 204 M-C 50	2CDS 274 001 R0504	54403 0				
	63	S 204 M-C 63	2CDS 274 001 R0634	54404 7				
U _{Bmax} 440 V ~ 125 V ∴ ④								

① suitable for flow-type heaters 12 kW
② suitable for flow-type heaters 18 kW

③ suitable for flow-type heaters 21, 24 and 27 kW
④ U_{Bmax} 125 V ∴ with 2 poles connected in series

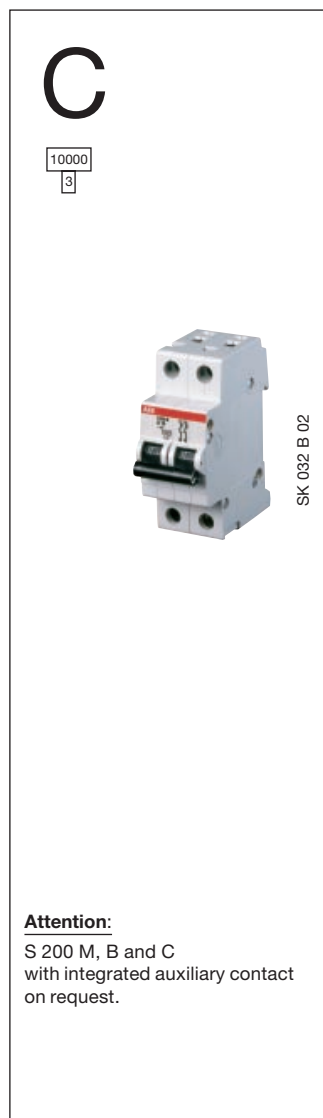

Selection table

No. of poles	rated current I _n A	order details type code	order code	bbn 40 16779 EAN	price 1 piece €	price group	w'ght 1 pc. kg	pack. unit pc.
1 + NA	0.5	S 201 M-C 0.5 NA	2CDS 271 103 R0984	55005 5			0.250	5
	1	S 201 M-C 1 NA	2CDS 271 103 R0014	55007 9				
	1.6	S 201 M-C 1.6 NA	2CDS 271 103 R0974	55006 2				
	2	S 201 M-C 2 NA	2CDS 271 103 R0024	55008 6				
	3	S 201 M-C 3 NA	2CDS 271 103 R0034	55009 3				
	4	S 201 M-C 4 NA	2CDS 271 103 R0044	55010 9				
	6	S 201 M-C 6 NA	2CDS 271 103 R0064	55011 6				
	8	S 201 M-C 8 NA	2CDS 271 103 R0084	55012 3				
	10	S 201 M-C 10 NA	2CDS 271 103 R0104	55013 0				
	13	S 201 M-C 13 NA	2CDS 271 103 R0134	55014 7				
	16	S 201 M-C 16 NA	2CDS 271 103 R0164	55015 4				
	20 ①	S 201 M-C 20 NA	2CDS 271 103 R0204	55016 1				
	25	S 201 M-C 25 NA	2CDS 271 103 R0254	55017 8				
	32 ②	S 201 M-C 32 NA	2CDS 271 103 R0324	55018 5				
	40 ③	S 201 M-C 40 NA	2CDS 271 103 R0404	55019 2				
	50	S 201 M-C 50 NA	2CDS 271 103 R0504	54395 8				
63	S 201 M-C 63 NA	2CDS 271 103 R0634	54396 5					
3 + NA	0.5	S 203 M-C 0.5 NA	2CDS 273 103 R0984	55051 2			0.500	2
	1	S 203 M-C 1 NA	2CDS 273 103 R0014	55052 9				
	1.6	S 203 M-C 1.6 NA	2CDS 273 103 R0974	55050 5				
	2	S 203 M-C 2 NA	2CDS 273 103 R0024	55053 6				
	3	S 203 M-C 3 NA	2CDS 273 103 R0034	55054 3				
	4	S 203 M-C 4 NA	2CDS 273 103 R0044	55055 0				
	6	S 203 M-C 6 NA	2CDS 273 103 R0064	55056 7				
	8	S 203 M-C 8 NA	2CDS 273 103 R0084	55057 4				
	10	S 203 M-C 10 NA	2CDS 273 103 R0104	55058 1				
	13	S 203 M-C 13 NA	2CDS 273 103 R0134	55059 8				
	16	S 203 M-C 16 NA	2CDS 273 103 R0164	55060 4				
	20 ①	S 203 M-C 20 NA	2CDS 273 103 R0204	55061 1				
	25	S 203 M-C 25 NA	2CDS 273 103 R0254	55062 8				
	32 ②	S 203 M-C 32 NA	2CDS 273 103 R0324	55063 5				
	40 ③	S 203 M-C 40 NA	2CDS 273 103 R0404	55064 2				
	50	S 203 M-C 50 NA	2CDS 273 103 R0504	54401 6				
63	S 203 M-C 63 NA	2CDS 273 103 R0634	54402 3					

① suitable for flow-type heaters 12 kW
② suitable for flow-type heaters 18 kW

③ suitable for flow-type heaters 21, 24 and 27 kW

Supplementary devices MCB's Range S 200/S 200 M

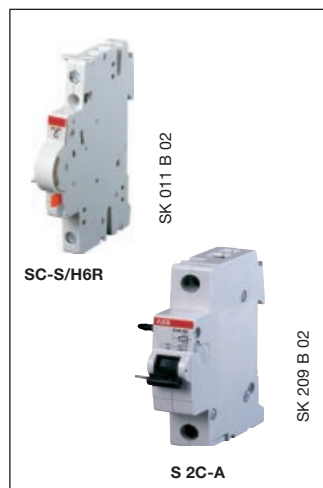

Description	order details type code	order code	bbn 40 16779 EAN	price 1 piece €	price group	w'ght 1 pc. kg	pack. unit pc.
Signalcontact/Auxiliary switch (universal) Retrofittable to the right side of MCB's, RCB's and Shunt trip's							
1 change over	S 2C-S/H6R	2CDS 200 922 R0001	56381 9			0.04	1
Auxiliary contact Retrofittable to the right side of MCB's							
1 change over	S 2C-H6R	2CDS 200 912 R0001	56382 6			0.04	1
Shunt trip							
AC/DC 12 ... 60 V	S 2C-A1	2CDS 200 909 R0001	57099 2			0.15	1
AC 110 ... 415 V und DC 110 ... 250 V	S 2C-A2	2CDS 200 909 R0002	57100 5				
Undervoltage release (in preparation)							
DC 12 V	S 2C-UA 12	2CDS 200 911 R0001	57101 2			0.09	1
AC/DC 24 V	S 2C-UA 24	2CDS 200 911 R0002	57102 9				
AC/DC 48 V	S 2C-UA 48	2CDS 200 911 R0003	57103 6				
AC/DC 110 V	S 2C-UA 110	2CDS 200 911 R0004	57104 3				
AC/DC 220 V	S 2C-UA 220	2CDS 200 911 R0005	57105 0				
AC 380 V	S 2C-UA 380	2CDS 200 911 R0006	57106 7				

Areas of application	DIN VDE...	Required sensitivity I _n mA	F 200 F 660 F 670	F 200 F 690 S	F 172 FS 200	F220 F 804
In apartments ≤32 A Socket-outlets up to 20 A Outdoor lightning installations	0100 – 739 0100 – 470 0100 – 714	10...30 10...30 10...30	F 200 F 660 F 670		F 172 FS 200	
Fire protection in high-risk or high-danger areas	0100 – 482	10 u. 30	F 200 F 660 F 670	F 200 F 690	F 172 FS 200	
Rooms with bath tub or shower Swimming pools	0100 – 701 0100 – 702	10...30 10...30	F 200 F 660 F 670		F 172 FS 200	
Construction sites Socket-outlet circuits up to 32 A and other socket-outlet circuits	0100 – 704 BG F&E	10...30 ≤300...500 ^①	F 200 F 660 F 670	F 200 F 690	F 172 FS 200	F 220 F 804 Type B
Agricultural and horticultural properties, General socket-outlet circuits	0100 – 705	≤300...500 ^① 10...30	F 200 F 660 F 670	F 200 F 690	F 172 FS 200 F 270 P 270	
Feed points for caravans Camp sites	0100 – 708	10...30	F 200 F 660 F 670		F 172 FS 200	
Berths Socket-outlets	0100 – 721	10...30	F 200 F 660 F 670		F 172 FS 200	
Temporary buildings, carny carriages and caravans, Feed points	0100 – 722	30 and 300	F 200 F 660 F 670	F 200 F 690	F 172 FS 200	
Medical rooms Group 1 Group 2 a Group 2 b	0100 – 710	at I _n ≤ 32 A 10...30 10...30 ≤ 300	F 200 F 660 F 670	F 200 F 690	F 172 FS 200	F 220 F 804 Type B
Equipment of power installations with electronic items I _{ab} type A, test for type B	0160 DIN EN 50 178	≤ 4kVA 10...30 > 4kVA 300	F 200 F 660 F 670	F 200 F 690	F 172 FS 200	F 220 F 804 Type B
Photovoltaics	0100 – 712 E EnBW	≤ 30				F 220 F 802 Type B

① Operating areas subject to fire hazards... VdS 2033: 2002 – 02 ≤ 300 mA

MCB's and RCB's

Type	Approvals												Ship classification associations			
Sign of conformity																
Code	SEV	BD 6 DEMKO	NEMKO	SEMKO	EL.	① CSA Inspect. CDN	① USA	KEMA	ÖVE	CEBEC	UTE	VDE	BV	GL	LRS	DNV
Valid for	CH	DK	N	S	SF	277/480 V~		NL	A	B	F	D	F	D	GB	N
S 200, B, C 1 – 4 pole	<input type="checkbox"/>	<input type="checkbox"/>	<input type="checkbox"/>	<input type="checkbox"/>	<input type="checkbox"/>		<input checked="" type="checkbox"/>	<input type="checkbox"/>	<input type="checkbox"/>	<input type="checkbox"/>	<input type="checkbox"/>	<input checked="" type="checkbox"/>	<input type="checkbox"/>	<input type="checkbox"/>	<input type="checkbox"/>	<input type="checkbox"/>
S 200 M 1 – 4 pole	<input type="checkbox"/>	<input type="checkbox"/>	<input type="checkbox"/>	<input type="checkbox"/>	<input checked="" type="checkbox"/>			<input type="checkbox"/>	<input type="checkbox"/>	<input type="checkbox"/>	<input type="checkbox"/>	<input checked="" type="checkbox"/>	<input type="checkbox"/>	<input type="checkbox"/>	<input type="checkbox"/>	<input type="checkbox"/>
F 200 - 16/25/ 40 – 0.01/ 0.03/0.1/ 0.3/0.5							<input checked="" type="checkbox"/>									
F 200 A, AC, S 2/4 pole 16...63 A 0.01...0.5 A	<input checked="" type="checkbox"/>	<input checked="" type="checkbox"/>	<input checked="" type="checkbox"/>	<input checked="" type="checkbox"/>	<input checked="" type="checkbox"/>			<input type="checkbox"/>	<input checked="" type="checkbox"/>	<input type="checkbox"/>	<input type="checkbox"/>	<input checked="" type="checkbox"/>				
FS 201 B 6...40/0,03 A C 16/0,03	<input checked="" type="checkbox"/>	<input checked="" type="checkbox"/>	<input checked="" type="checkbox"/>	<input checked="" type="checkbox"/>	<input checked="" type="checkbox"/>			<input type="checkbox"/>	<input checked="" type="checkbox"/>	<input type="checkbox"/>	<input type="checkbox"/>	<input checked="" type="checkbox"/>				

- approved
- submitted for aproval/planed to be submitted
- △ Approved variants on request
- Approval not required

① Back-up protection usually required.
For details contact your importer and/or inspector.



ABB STOTZ-KONTAKT GmbH

P.O. Box 10 16 80, 69006 Heidelberg, Germany
Eppelheimer Straße 82, 69123 Heidelberg, Germany
Telephone: +49 (0) 62 21 701- 0
Fax: +49 (0) 62 21 701-723
www.abb.de/stotz-kontakt

X-ON Electronics

Largest Supplier of Electrical and Electronic Components

Click to view similar products for [Circuit Breakers](#) category:

Click to view products by [ABB](#) manufacturer:

Other Similar products are found below :

[M39019/04-249S](#) [M39019/04-313S](#) [M55629/1-001](#) [M55629/1-016](#) [M55629/1-018](#) [M55629/1-021](#) [M55629/1-033](#) [M55629/1-036](#) [M55629/1-046](#) [M55629/1-048](#) [M55629/1-058](#) [M55629/1-060](#) [M55629/1-067](#) [M55629/1-070](#) [M55629/1-079](#) [M55629/1-084](#) [M55629/1-085](#) [M55629/1-101](#) [M55629/1-108](#) [M55629/1-109](#) [M55629/11-102](#) [M55629/1-120](#) [M55629/12-045](#) [M55629/12-046](#) [M55629/1-243](#) [M55629/1-330](#) [M55629/1-331](#) [M55629/1-351](#) [M55629/1-366](#) [M55629/1-387](#) [M55629/1-388](#) [M55629/1-401](#) [M55629/1-430](#) [M55629/1-450](#) [M55629/1-453](#) [M55629/2-022](#) [M55629/2-037](#) [M55629/2-082](#) [M55629/2-099](#) [M55629/2-101](#) [M55629/2-102](#) [M55629/2-115](#) [M55629/2-116](#) [M55629/2-183](#) [M55629/21-HM-HM](#) [M55629/21-NS-NS](#) [M55629/21-SK-UK](#) [M55629/22-NR-NR-NR](#) [M55629/22-RS-RS-RS](#) [M55629/22-TM-TM-TM](#)