

Relays

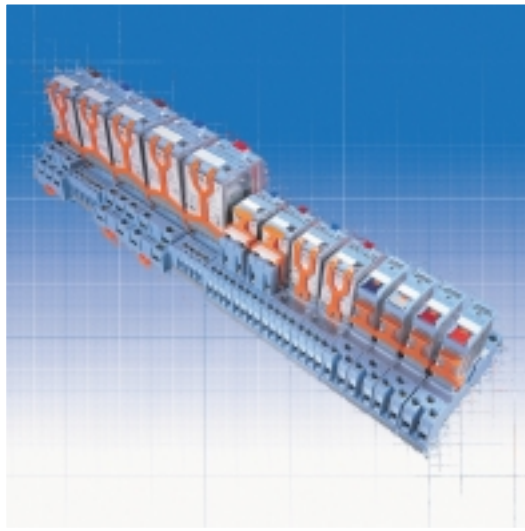

- Full Featured Industrial Plug-In Relays
- Single Pole Interface to Four Pole Power Switching
- Low Level Signal to High Power DC Switching
- Latching & Low Consumption Coil Options
- Plug In Timer Cube Options

CONTENTS

Relays

Selection Guide & Part No Key	40
General Information	41
General Information	42
General Information	43
MRC 8 Pin C2 Relays	44
MRC 11 Pin C3 Relays	45
MRC 11 Pin C3 Relays	46
MRC 11 Pin C3 Relays	47
MRC 14 Pin C4 Relays	48
MRC 11 Pin C5 Relays	49
MRC 11 Pin C5 Relays	50
QRC 8 Pin Miniature C7 Relays	51
QRC 8 Pin Miniature C7 Relays	52
QRC 14 Pin Miniature C9 Relays	53
IRC Single Pole Interface C10 Relays	54
Time Cubes	55
Sockets For C2 Relays	56
Sockets For C3 Relays	57
Module Sockets & Modules for C3 Relays	58
Sockets For C4 & C5 Relays	59
Sockets For C7 Relays	60
Sockets For C9 & C10 Relays	61

RELECO

MRC, QRC & IRC SERIES

Application	Types	Poles	AC ratings	DC ratings	Page	Sockets	Page	
General purpose	C2-A20	8 pin	2 C	10A / 250V	0,5A @ 110V	44	S2	56
	C3-A30	11 pin	3 C	10A / 250V	0,5A @ 110V	45	S3	57
	C4-A40	14 pin flat blade	4 C	10A / 250V	0,5A @ 110V	48	S4	59
	C5-A20	11 pin flat blade	2 C	16A / 500V	0,5A @ 110V	49	S5	59
	C5-A30	11 pin flat blade	3 C	16A / 500V	0,5A @ 110V	49	S5	59
	C7-A10	8 pin miniature flat blade	1 C	16A / 250V	0,5A @ 110V	51	S7	60
	C7-A20	8 pin miniature flat blade	2 C	10A / 250V	0,5A @ 110V	51	S7	60
	C9-A41	14 pin miniature flat blade	4 C	3A / 250V	0,5A @ 110V	53	S9	61
	C10-A10	5 pin flat blade	1 C	10A / 400V	0,5A @ 110V	54	S10	61
Twin contacts Low level loads	C2-T21	8 pin	2 C	6A / 250V	Min. 5mA @ 5V	44	S2	56
	C3-T31	11 pin	3 C	6A / 250V	Min. 5mA @ 5V	45	S3	57
	C7-T21	8 pin miniature flat blade	2 C	6A / 250V	Min. 5mA @ 5V	51	S7	60
	C10-T13	5 pin flat blade	1 C	6A / 400V	Min. 1mA @ 5V	54	S10	61
Open contacts DC load switching Flag not available	C2-G20	8 pin	2 NO	10A / 250V	1,2A @ 110V	44	S2	56
	C3-G30	11 pin	3 NO	10A / 250V	1,2A @ 110V	45	S3	57
	C5-G30	11 pin flat blade	3 NO	16A / 500V	1,2A @ 110V	49	S5	59
	C7-G20	8 pin miniature flat blade	2 NO	10A / 250V	0,8A @ 110V	52	S7	60
Double make DC load switching Flag not available	C3-X10	11 pin	1 DM	10A / 250V	7A @ 110V	46	S3	57
	C4-X20	14 pin flat blade	2 DM	10A / 250V	7A @ 110V	48	S4	59
	C5-X10	11 pin flat blade	1 DM	10A / 250V	7A @ 110V	50	S5	59
	C7-X10	8 pin miniature flat blade	1 DM	10A / 250V	6A @ 110V	52	S7	60
Magnet blow-out Flag not available	C3-M10	11 pin	1 DM	10A / 250V	10A @ 220V	46	S3	57
	C5-M10	11 pin flat blade	1 DM	16A / 500V	10A @ 220V	50	S5	59
Latching LED not available	C3-R20	11 pin	2 C	10A / 250V	0,5A @ 110V	46	S3	57
	C4-R30	14 pin flat blade	3 C	10A / 250V	0,5A @ 110V	48	S4	59
	C5-R20	11 pin flat blade	2 C	10A / 250V	0,5A @ 110V	50	S5	59
	C9-R21	14 pin miniature flat blade	2 C	3A / 250V	0,5A @ 110V	53	S9	61
Sensitive 250mW ... 800mW Flag not available LED not available	C3-S14	11 pin	1 C	6A / 250V	0,5A @ 110V	47	S3	57
	C3-E24	11 pin	2 C	6A / 250V	0,5A @ 110V	47	S3	57
	C3-N34	11 pin	3 C	6A / 250V	0,5A @ 110V	47	S3	57
	C9-E21	14 pin miniature flat blade	2 C	3A / 250V	0,5A @ 110V	53	S9	61
Lamp switching	C7-W10	Miniature, faston 187	1 NO	10A / 250V	0,5A @ 110V	52	S7	60
Time cube	CT2	8 pin plug-in timer module	2 C	10A / 250V	0,5A @ 110V	55	S2	56
	CT3	11 pin plug-in timer module	3 C	10A / 250V	0,5A @ 110V	55	S3	57

PART NUMBER KEY

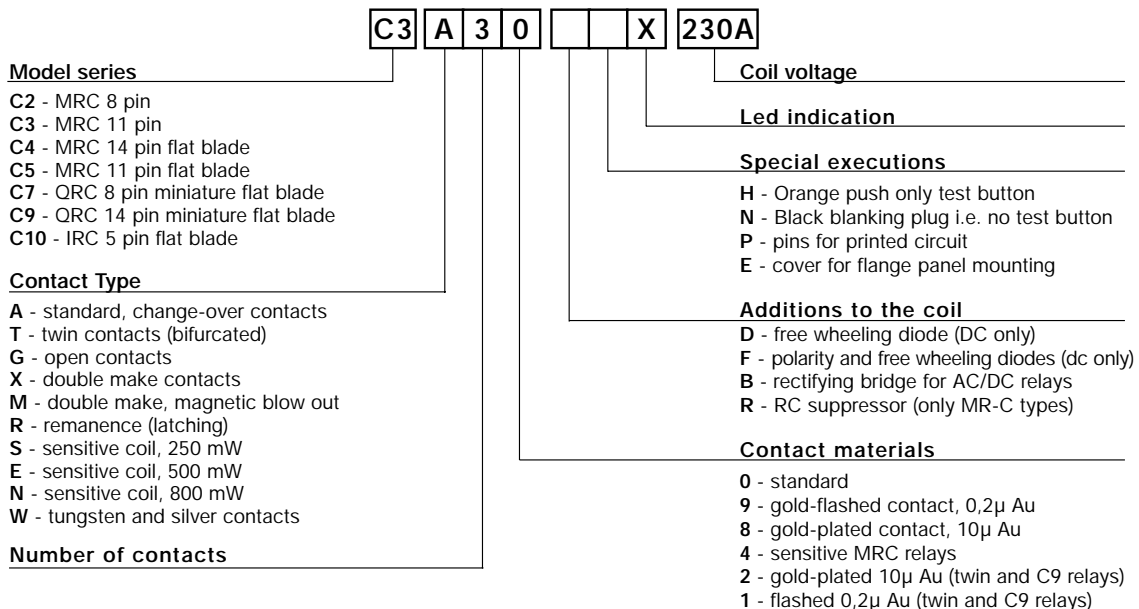

GENERAL INFORMATION

Contact materials

Silver-nickel (AgNi) and silver-tin oxide (AgSnO₂) are used as standard contact materials for all models. Other contact materials are available on request.

Gold Flash

For relays that are intended to be stored or remain unoperated for any length of time, a 0,2µ layer of gold protects the contacts from oxidisation.

Gold Plating

A 10µ plate of gold increases the operational reliability. They should be used for switching low level currents.

Contact Resistance

Contact resistance is dependent on contact material, contact pressure and contact contamination.

High contact resistance raises the temperature of the contacts, therefore reducing their working life.

Typical contact resistance of the MR-C and QR-C relays is 50 mΩ.

Contacts gap

Contact gap and opening speed of the contacts have an influence on the length and the duration of the arc.

In the case of AC, a gap of 0,5 mm is sufficient to quench the arc which occurs automatically at the "zero point" of the cycle.

In the case of DC, the arc only quenches when the contact gap is sufficient for the voltage and current applied.

Please see tables of "Max. DC current".

Coil Materials

Coils bobbins are moulded in poly-butylene with fibreglass (130° C). Enamelled wires of Class F specification are used (155° C).

They are wound on automatic precision winding machines, with the number of turns and wire tension accurately regulated and monitored.

Tolerances

Coil resistance is measured at 20° C and is regulated within ± 10% of specified value.

Standard Windings

The coil voltages indicated in the catalogue refer to standard windings. Other coil voltages are available, including products for series connection and amperometric applications. Please consult your distributor for details.

Maximum Intensity

The "Max. switching current" indicated in every model, refers to the maximum stable current which should be possible in permanent conduction (ITH).

In the case of AC, the "Max. switching current" that the relay can support is the same for all the values of voltages ≤ of the "Max. switching voltage" specified in every model.

The product of the intensity and the voltage applied should not be higher than the values specified as "Max. AC load".

In the case of DC, the "Max. switching current" must be less than the current that causes the continuous arcing.

The tables of "Max. DC current" show the possible values of intensity in relation to the applied voltage.

Maximum Voltage

The maximum voltage on the contacts depends on the insulation between each contact (pole to pole) and between all contacts and the coil.

The EN60947 and VDE 0110 standards set out the maximum voltage values, taking into consideration the quality of the insulation materials, pollution degree as well as the shape and dimensions of the contact barriers (creepage distance).

Contacts in series

The connection of two or more contacts in series is equivalent to multiplying the contact gap by that amount. By using this method, a greater break capacity is achieved for DC switching.

Minimum working voltage (pull in)

This is the minimum voltage that must be supplied to the coil to ensure that the relay energises, the contacts change over and are positively held in place without any vibration. The values of voltage specified are those at or above which the relay must pull in.

DC relays ≥ 80% **Un**
AC relays ≥ 80% **Un**

Maximum release voltage (drop out)

This is the voltage at which the relay de-energises, the contacts change over and are positively held in place without any vibration.

The values of voltage specified are those at or below which the relay must drop out.

DC relays ≥ 10% **Un**
AC relays ≤ 15% **Un**

Contacts in parallel

The connection of two or more contacts in parallel does not mean that it is possible to switch a greater load. However, the stable current and the operational reliability of the relay is increased.

Double break contacts

The double break contact arrangement is equivalent to two contacts connected in series.

The maximum intensity supported corresponds to only one contact. This system allows for higher DC operating voltages.

Bifurcated (twin) contacts

The contact blade is divided into two parts, each with its own contact. Both contacts press down each on their own independent fixed contacts.

This system is particularly good for reliably switching at very low levels.

Contact protection

The electrical life of contacts can be prolonged by components which eliminate or reduce the back EMF transients.

These voltages are generated by the reactive component of the load on disconnection, which increases the duration and the temperature of the arc.

For AC, RC suppressors or varistors can be connected in parallel with the load or the contacts.

For DC with an inductive load, the best method is to connect a diode in parallel with the load.

Ambient temperature

The ambient temperature has an influence on the coil resistance and on its thermal dissipation capacity.

Curve 1 represents the variations of the pull in voltage (% **Un**) in relation with the ambient temperature (**T**).

Curve 2 indicates the maximum values of the voltage applied (**Ub**) to the coil in relation with the nominal voltage (**Un**) at the ambient temperature (**T**).

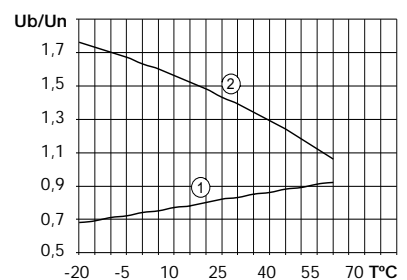

GENERAL INFORMATION

A **General purpose relays**
They are used for most general applications, like as automation, pneumatic, heating appliances, signaling, as an input or output interface, etc.

Change-over contacts. Isolation between NO/NC: 1000 Vrms. Gap: 0,5 mm.

Rating loads of up to 16A @ 230V AC1
16 A @ 30V DC1
0,5A @ 110V DC1 0,2A @ 220V DC1

MR-C coils C2-A20 and C3-A30

Vac	Ω	mA	Vdc	Ω	mA
24	67	92	12	110	110
48	280	46	24	443	54
115	1K7	19	48	1K8	27
230	7K2	9,5	110	9K	12
400*	19K	5,5	220	37K	6

* 400V coils only in pollution 2

MR-C coils C4-A40, C5-A20, C5-A30

Vac	Ω	mA	Vdc	Ω	mA
24	65	100	12	103	116
48	280	50	24	411	58
115	1K6	21	48	1K6	30
230	6K8	10	110	8K6	13
400*	18K	6	220	34K	6,5

* C4-A40 , 400V coils only in pollution 2

QR-C coils C7-A20, C9-A41

Vac	Ω	mA	Vdc	Ω	mA
24	147	62	12	140	85
48	607	31	24	555	43
115	3K7	13	48	2K3	21
230	14K	6,5	110	9K8	11

T **Relays with twin contacts**
These are used to switch low currents with high operational reliability.

Change-over contacts. Isolation between contacts NO/NC: 1000 Vrms.

Gap: 0,5 mm
Gold-flashed contact 0,2μ or plated with 10μ Au (optional).

Maximum load: 6A @ 230V AC1
Minimum load: 5 mA @ 5V DC1

MR-C coils C2-T21 and C3-T31

Vac	Ω	mA	Vdc	Ω	mA
24	67	92	12	110	110
48	280	46	24	443	54
115	1K7	19	48	1K8	27
230	7K2	9,5	110	9K3	12
400*	19K	5,5	220	37K	6

* 400V coils only in pollution 2

QR-C coils C7-T21

Vac	Ω	mA	Vdc	Ω	mA
24	147	62	12	140	85
48	607	31	24	555	43
115	3K7	13	48	2K3	21
230	14K	6,5	110	9K8	11

G **Relays with open contacts**
An open contact arrangement allows an increase in the contact gap, increasing the DC "break capacity" without altering the AC performance.

Gap: 1,5 mm (QR-C types); 1,7 mm (MR-C)
Isolation of contacts NO: >2000 Vrms.

Maximum load: 16A @ 230V AC1
1,2A @ 110V DC1 0,4A @ 220V DC1

MR-C coils C2-G20, C3-G30, C5-G30

Vac	Ω	mA	Vdc	Ω	mA
24	60	100	12	90	133
48	268	50	24	360	66
115	1K7	21	48	1K4	34
230	5K8	10	110	7K5	15
400*	16K	6	220	30K	7,5

* C2-G20, C3-G30 400V only in pollution 2

QR-C coils C7-A10, C7-G20, C7-X10

Vac	Ω	mA	Vdc	Ω	mA
24	132	83	12	96	125
48	535	42	24	384	62
115	3K1	17	48	1K5	32
230	12K	8,7	110	8K	13

X **Double break relays**
These relays are designed to switch high DC loads at voltages of 110 and 220 Vdc.

They consist of one normally open contact with a gap >3 mm so that the arc length is divided by two.

Isolation between contacts: >2000 Vrms
The max. DC load is shown in the tables.
X versions are available in MR-C and QR-C type housing.

MR-C coils C3-X10, C4-X20, C5-X10

Vac	Ω	mA	Vdc	Ω	mA
24	60	100	12	110	110
48	268	50	24	443	54
115	1K7	21	48	1K8	27
230	5K8	10	110	9K	12
400*	16K	6	220	37K	6

* C3-X10, C4-X20 400V only in pollution 2

M **Relays with "mag. blow out"**
These versions are similar to X types, however they have the addition of a powerful magnet which "blows out" the arc generated when the contacts are opened, therefore quenching the arcing quickly and increasing the contact life.

See Tables 6 and 7. On page 46

They are able to switch DC loads of up to 10A @ 220V DC1 and 2A @ 220V DC13

MR-C coils C3-M10 and C5-M10

Vac	Ω	mA	Vdc	Ω	mA
24	60	100	12	110	110
48	268	50	24	443	54
115	1K7	21	48	1K8	27
230	5K8	10	110	9K	12
400*	16K	6	220	37K	6

* C3-M10 , 400V coils only in pollution 2

R **Remanence relays**
A high remanence magnetic circuit allows the relay to latch positively when the current applied flows through the coil in a direction and delatches if the current flows in the opposite direction.
Electronic circuitry is added inside the relay to control this action and also protects against transient voltages.

There is one winding for AC coils and two windings for DC coils.

All coils withstand permanent connection. The relay can be operated with pulses of 50 ms., minimum, at nominal voltage.

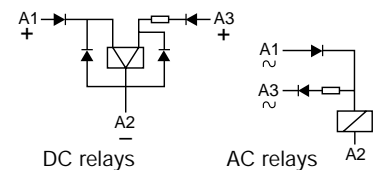

MR-C coils C3-R20, C4-R30, C5-R20

Vac	ON mA	OFF mA	Vdc	ON mA	OFF mA
24	75	12	12	24	30
48	38	6	24	62	21
115	16	2,5	48	32	10
230	8	1,3	110	13	6

QR-C coils C9-R21

Vac	ON mA	OFF mA	Vdc	ON mA	OFF mA
24	50	8	12	100	25
48	25	4	24	50	12
115	10	2	48	25	6
230	5	1	60	20	5

GENERAL INFORMATION

- S** Sensitive relays, 250 mW
One change-over contact
- E** Sensitive relays, 500 mW
Two change-over contacts
- N** Sensitive relays, 800 mW
Three change-over contacts

DC relays adjusted to work at lower power, available in both MR-C and QR-C versions. Gold-flashed contacts 0,2µ or plated 10µ Au (optional).

Operational voltage range:
S relays: 0,8 ... 2,5 **Un**
E relays: 0,8 ... 1,7 **Un**
N relays: 0,8 ... 1,4 **Un**

Coils Relays C3-S, C3-E, C3-N, C9-E

Vdc	Relays S		Relays E		Relays N	
	Ω	mA	Ω	mA	Ω	mA
6	144	42	72	83	45	133
12	576	21	288	42	180	66
24	2K3	10	1K1	21	720	33
48	9K2	5	4K6	10	2K8	17
60			7K2	8,3	4K5	13
110					15K	7

W High inrush current relay
 Two open contacts, one of silver nickel and one of tungsten work in parallel but are physically displaced so that the tungsten contact makes and breaks the load. The silver contact is used for carrying the stable current.

This relay was designed to switch incandescent and fluorescent lamps, (with p.f corrected), and DC inductive loads.

Only available in **C7** type housing.

Maximum loads:
 6A @ 230 AC5a/b (lamps)
 10A @ 230V AC15; 1,5A @ 110V DC1

See table of electrical life on page 52.

QR-C coils			Relays C7-W		
Vac	Ω	mA	Vdc	Ω	mA
24	132	83	12	110	110
48	535	42	24	443	54
115	3K1	17	48	1K8	27
230	12K	8,7	110	9K	12

Specifications

The data referred to in the specifications for each model refers to typical values of "new" relays at 20° C.

Tables

The tables of electrical life and the tables of maximum DC current show the typical result of exhaustive tests performed at an ambient temperature of 20° C, operating frequency of 1200 operations / hour, and under permanent connection.

The switching current ratings specified in the catalogue refer to a minimum electrical life of 100.000 operations.

Margin of over-voltage

A maximum over-voltage of 110% **Un** is permissible at the coil, with rated current through the contacts at an ambient temperature of 60° C.

Custom relays

Relays with special specifications can be supplied after consultation with an official Releco distributor.

Protection against transients

When the coil is disconnected from an electromagnet, peaks of inverse voltage appear at the terminals which can reach very high values. These pulses can be transmitted down the line associated with the coil and could possibly affect other components.

In the case of a relay being operated by such devices as transistors, triacs, etc; it may be necessary to protect against transients.

Transients carried in the line

High voltage pulses can be carried in the supply line to the relay coil. These may appear in the form of peaks or bursts and are generated by the connection and disconnection of electric motors, transformers, capacitors etc.

Normally a relay is unaffected by these pulses, but if a diode is connected in association with the coil, it must be capable of withstanding an inverse voltage higher than those of the incoming peaks.

Protection circuits

A protection circuit must efficiently cope with pulses generated by the coil as well as incoming line pulses.

EN61000 norms set levels of protection for each application.

Releco relays are available with integrated protection circuits or with modules plugged into sockets S3-MP or S3-MS.

X LED indication with rectifier.
 For DC and AC relays up to 250V
 Level II (1000V) up to 24V
 Level III (2000V) from 25 to 60V
 Level IV (4000V) from 61 to 250V
 Note: LED connected in series with the coil @ 220Vdc in QRC types.

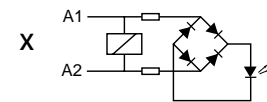

D Free wheeling diode.
DX Free wheeling diode + LED
 Dampens transients caused by the relay coil on de-energisation.
 Level III (2000V) up to 60 Vdc
 Level IV (4000V) from 61 to 250 Vdc (*)

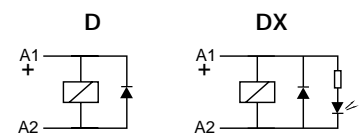

F Polarity and free wheeling diodes.
FX Polarity + free wheeling diode + LED
 A diode in series with the coil protects the relay from reverse connection.
 Level II (1000V) up to 60 Vdc
 Level IV (4000V) from 61 to 250 Vdc (*)

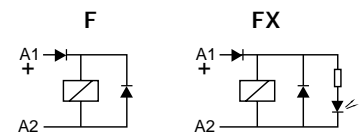

B Bridge rectifier incorporated.
BX Bridge rectifier + LED indication
 Allows the relay to operate in both AC or DC without any polarity inconvenience.
 Available only in voltages up to 60V
 Protection level II (1000V)

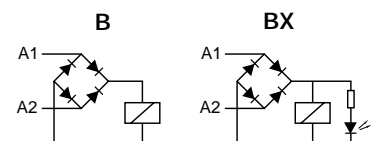

R Resistor and capacitor.
RX Resistor and capacitor + LED
 Suppressor for AC coils. Level III (2000V)
 Available only in **MRC** types

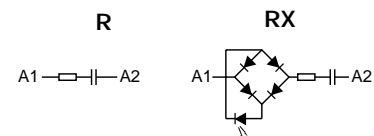

(*) Level III (2000V) in **QRC** types.



MRC 8 PIN STANDARD/LOW SIGNAL LEVEL/
OPEN CONTACTS

- Lockable test button
- Marking label on relay
- 2 window mechanical flag (not available on C2-G20)
- Colour coded test button
- Coil voltage marked on top of relay
- Label carries full technical information
- CE marked

C2-A20... General purpose
Two change-over contacts, 10 A

10A / 250V AC1	10A @ 30V DC1
6A / 250V AC15	0,5A @ 110V DC1

Contacts
Materials code 0 (standard); options: 8 - 9
Max. switching current 10 A
Peak inrush current (20 ms) 30 A
Max. switching voltage, (pollution 3) 250 V
Max. switching voltage, (pollution 2) 400 V
Max. AC load (Table 1) 2,5 KVA
Max. DC load See Table 2

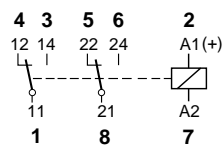

Standard types (50/60 Hz and DC)
AC 24, 48, 115 (110 ... 120), 230
X = LED (optional) C2-A20 X/ ... V
RC suppressor C2-A20R X/ ... V

DC 12, 24, 48, 110, 120/125, 220
X = LED (optional) C2-A20 X/ ... V
Free wheeling diode C2-A20D X/ ... V
Free wheeling and polarity C2-A20F X/ ... V
AC/DC rectifier (60V max.) C2-A20B X/ ... V

Specifications
Nominal coil power: 2,2 VA (AC), 1,3 W (DC)
Operate time 16 ms.
Release time 8 ms.
Isolation: EN60947 pollution 3, Gr C 250V
Dielectric strength, contacts / coil 2,5 KV
Dielectric strength, pole / pole 2,5 KV

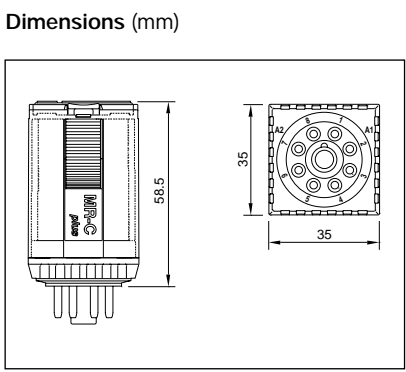

C2-T21... Low level
Two change-over, bifurcated contacts

6A / 250V AC1	6A @ 30V DC1
Min. 5mA @ DC 5V	

Contacts
Materials code 1 (standard); option: 2
Switching current: min. 5 mA; max. 6 A
Peak inrush current (5 ms) 15 A
Max. switching voltage, (pollution 3) 250 V
Max. switching voltage, (pollution 2) 400 V
Max. AC load (Table 3, page 45) 1,2 KVA
Max. DC load See Table 18, page 51

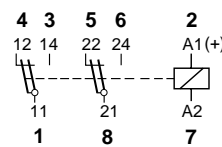

Standard types (50/60 Hz and DC)
AC 24, 48, 115 (110 ... 120), 230
X = LED (optional) C2-T21 X/ ... V
RC suppressor C2-T21R X/ ... V

DC 12, 24, 48, 110, 120/125, 220
X = LED (optional) C2-T21 X/ ... V
Free wheeling diode C2-T21D X/ ... V
Free wheeling and polarity C2-T21F X/ ... V
AC/DC rectifier (60V max.) C2-T21B X/ ... V

Specifications
Nominal coil power: 2,2 VA (AC), 1,3 W (DC)
Operate time 16 ms.
Release time 8 ms.
Isolation: EN60947 pollution 3, Gr C 250V
Dielectric strength, contacts / coil 2,5 KV
Dielectric strength, pole / pole 2,5 KV

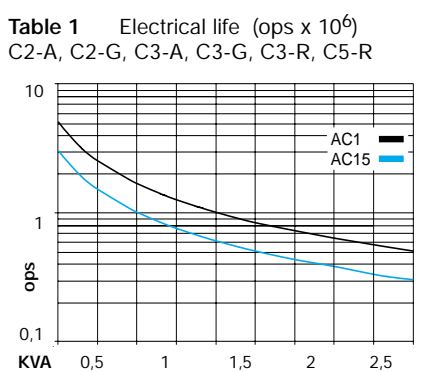
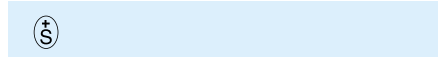

C2-G20... General purpose, DC
Two open contacts

10A / 250V AC1	0,3A @ 110V DC13
1,2A @ 110V DC1	0,4A @ 220V DC1

Contacts
Materials code 0 (standard)
Max. switching current 10 A
Peak inrush current (20 ms) 30 A
Max. switching voltage, (pollution 3) 250 V
Max. switching voltage, (pollution 2) 400 V
Max. AC load (Table 1) 2,5 KVA
Max. DC load See Table 4, page 45

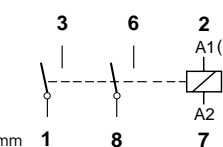

Standard types (50/60 Hz and DC)
AC 24, 48, 115 (110 ... 120), 230
X = LED (optional) C2-G20 X/ ... V
RC suppressor C2-G20R X/ ... V

DC 12, 24, 48, 110, 120/125, 220
X = LED (optional) C2-G20 X/ ... V
Free wheeling diode C2-G20D X/ ... V
Free wheeling and polarity C2-G20F X/ ... V
AC/DC rectifier (60V max.) C2-G20B X/ ... V

Specifications
Nominal coil power: 2,4 VA (AC), 1,6 W (DC)
Operate time 20 ms.
Release time 10 ms.
Isolation: EN60947 pollution 3, Gr C 250V
Dielectric strength, contacts / coil 2,5 KV
Dielectric strength, pole / pole 2,5 KV

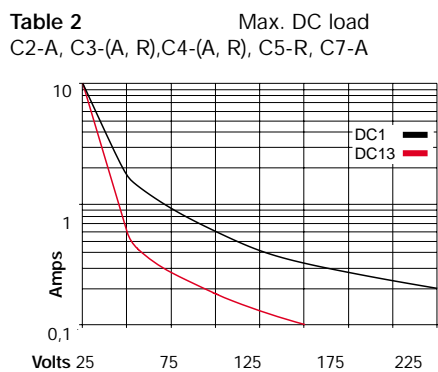
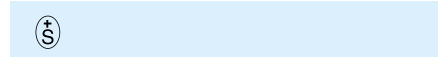



MRC 11 PIN STANDARD/LOW SIGNAL LEVEL/
OPEN CONTACTS

- Lockable test button
- Marking label on relay
- 2 window mechanical flag (not available on C3-G30)
- Colour coded test button
- Coil voltage marked on top of relay
- Label carries full technical information
- CE marked

C3-A30... General purpose
Three change-over contacts, 10 A

10A / 250V AC1 10A @ 30V DC1
6A / 250V AC15 0,5A @ 110V DC1

Contacts

Materials code 0 (standard); options: 8 - 9
Max. switching current 10 A
Peak inrush current (20 ms) 30 A
Max. switching voltage, (pollution 3) 250 V
Max. switching voltage, (pollution 2) 400 V
Max. AC load (Table 1, page 44) 2,5 KVA
Max. DC load See Table 2, page 44

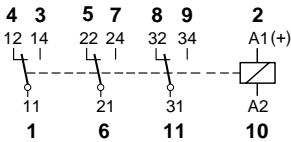

Standard types (50/60 Hz and DC)

AC 24, 48, 115 (110 ... 120), 230
X = LED (optional) **C3-A30** X/ ... V
RC suppressor **C3-A30R** X/ ... V

DC 12, 24, 48, 110, 120/125, 220
X = LED (optional) **C3-A30** X/ ... V
Free wheeling diode **C3-A30D** X/ ... V
Free wheeling and polarity **C3-A30F** X/ ... V
AC/DC rectifier (60V max.) **C3-A30B** X/ ... V

Specifications

Nominal coil power: 2,2 VA (AC), 1,3 W (DC)
Operate time 16 ms.
Release time 8 ms.
Isolation: EN60947 pollution 3, Gr C 250V
Dielectric strength, contacts / coil 2,5 KV
Dielectric strength, pole / pole 2,5 KV



Dimensions (mm)

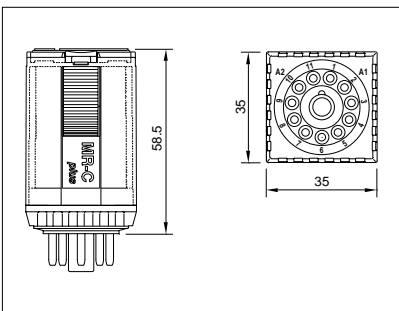

C3-T31... Low level
3 change-over, bifurcated contacts

6A / 250V AC1 6A @ 30V DC1
Min. 5mA @ DC 5V

Contacts

Materials code 1 (standard); option: 2
Switching current: min. 5 mA, max. 6 A
Peak inrush current (15 ms) 15 A
Max. switching voltage, (pollution 3) 250 V
Max. switching voltage, (pollution 2) 400 V
Max. AC resistive load (Table 3) 1,2 KVA
Max. DC load See Table 18, page 51

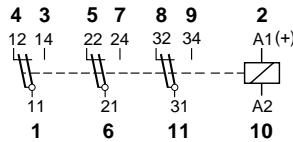

Standard types (50/60 Hz and DC)

AC 24, 48, 115 (110 ... 120), 230
X = LED (optional) **C3-T31** X/ ... V
RC suppressor **C3-T31R** X/ ... V

DC 12, 24, 48, 110, 120/125, 220
X = LED (optional) **C3-T31** X/ ... V
Free wheeling diode **C3-T31D** X/ ... V
Free wheeling and polarity **C3-T31F** X/ ... V
AC/DC rectifier (60V max.) **C3-T31B** X/ ... V

Specifications

Nominal coil power: 2,2 VA (AC), 1,3 W (DC)
Operate time 16 ms.
Release time 8 ms.
Isolation: EN60947 pollution 3, Gr C 250V
Dielectric strength, contacts / coil 2,5 KV
Dielectric strength, pole / pole 2,5 KV

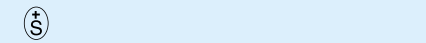
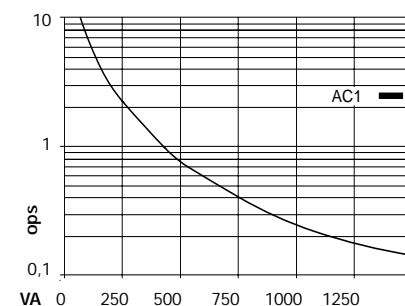

Table 3 Electrical life (ops x 10⁶)
Types C2-T21, C3-T31, C7-T21



C3-G30... General purpose, DC
Three open contacts

10A / 250V AC1 0,3A @ 110V DC13
1,2A @ 110V DC1 0,4A @ 220V DC1

Contacts

Materials code 0 (standard)
Max. switching current 10 A
Peak inrush current (20 ms) 30 A
Max. switching voltage, (pollution 3) 250 V
Max. switching voltage, (pollution 2) 400 V
Max. AC load (Table 1, page 44) 2,5 KVA
Max. DC load See Table 4

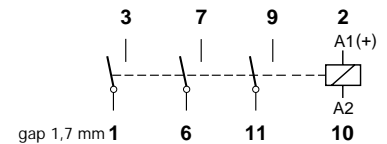

Standard types (50/60 Hz and DC)

AC 24, 48, 115 (110 ... 120), 230
X = LED (optional) **C3-G30** X/ ... V
RC suppressor **C3-G30R** X/ ... V

DC 12, 24, 48, 110, 120/125, 220
X = LED (optional) **C3-G30** X/ ... V
Free wheeling diode **C3-G30D** X/ ... V
Free wheeling and polarity **C3-G30F** X/ ... V
AC/DC rectifier (60V max.) **C3-G30B** X/ ... V

Specifications

Nominal coil power: 2,4 VA (AC), 1,6 W (DC)
Operate time 20 ms.
Release time 10 ms.
Isolation: EN60947 pollution 3, Gr C 250V
Dielectric strength, contacts / coil 2,5 KV
Dielectric strength, pole / pole 2,5 KV

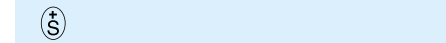
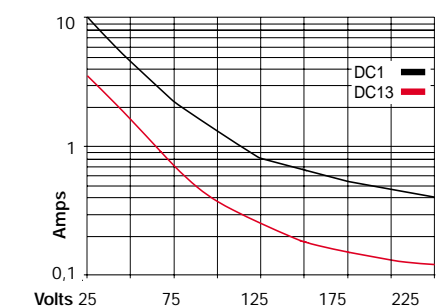

Table 4 Max. DC load
Types C2-G20, C3-G30





MRC 11 PIN POWER/MAGNETIC BLOW-OUT/LATCHING

- Lockable test button
- Marking label on relay
- 2 window mechanical flag (not available on C3X10 or C3-M10)
- Colour coded test button
- Coil voltage marked on top of relay
- Label carries full technical information
- CE marked

C3-X10... Power relay, DC
Single pole, NO, double make

10A / 250V AC1 1,2A @ 220V DC1
7A @ 110V DC1 0,3A @ 220V DC13

Contacts

Materials code 0 (standard)
Max. switching current 10 A
Peak inrush current (20 ms) 30 A
Max. switching voltage, (pollution 3) 250 V
Max. switching voltage, (pollution 2) 400 V
Max. AC load (Table 5) 2,5 KVA
Max. DC load See Table 10, page 48

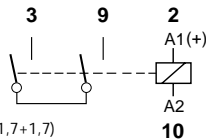

gap > 3 mm (1,7+1,7)

Standard types (50/60 Hz and DC)

AC 24, 48, 115 (110 ... 120), **230**
X = LED (optional) **C3-X10** X/ ... V
RC suppressor **C3-X10R** X/ ... V

DC 12, 24, 48, 110, 120/125, 220

X = LED (optional) **C3-X10** X/ ... V
Free wheeling diode **C3-X10D** X/ ... V
Free wheeling and polarity **C3-X10F** X/ ... V
AC/DC rectifier (60V max.) **C3-X10B** X/ ... V

Specifications

Nominal coil power: 2,4 VA (AC), 1,3 W (DC)
Operate time 20 ms.
Release time 10 ms.
Isolation: EN60947 pollution 3, Gr C 250V
Dielectric strength, contacts / coil 2,5 KV



Table 5 Electrical life (ops x10⁶)
Types C3-X10 and C3-M10

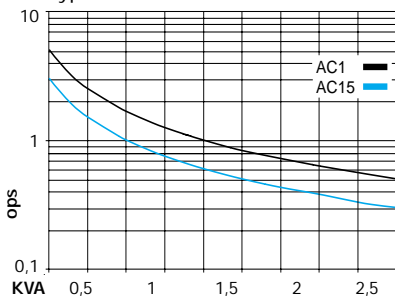

C3-M10... Power relay, DC
Single pole, magnetic blow out

10A / 250V AC1 10A @ 220V DC1
3,6A @ 110V DC13 2A @ 220V DC13

Contacts

Materials code 0 (standard)
Max. switching current 10 A
Peak inrush current (20 ms) 30 A
Max. switching voltage, (pollution 3) 250 V
Max. switching voltage, (pollution 2) 400 V
Max. AC load (Table 5) 2,5 KVA
Electrical life, DC See Tables 6 and 7

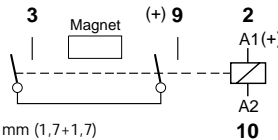

gap > 3 mm (1,7+1,7)

Standard types (50/60 Hz and DC)

AC 24, 48, 115 (110 ... 120), **230**
X = LED (optional) **C3-M10** X/ ... V
RC suppressor **C3-M10R** X/ ... V

DC 12, 24, 48, 110, 120/125, 220

X = LED (optional) **C3-M10** X/ ... V
Free wheeling diode **C3-M10D** X/ ... V
Free wheeling and polarity **C3-M10F** X/ ... V
AC/DC rectifier (60V max.) **C3-M10B** X/ ... V

Specifications

Nominal coil power: 2,4 VA (AC), 1,3 W (DC)
Operate time 20 ms.
Release time 10 ms.
Isolation: EN60947 pollution 3, Gr C 250V
Dielectric strength, contacts / coil 2,5 KV

C3-R20... Latching
Two change-over contacts, 10 A

10A / 250V AC1 10A @ 30V DC1
6A / 250V AC15 0,5A @ 110VDC1

Contacts

Materials code 0 (standard); options: 8 - 9
Max. switching current 10 A
Peak inrush current (20 ms) 30 A
Max. switching voltage, (pollution 3) 250 V
Max. switching voltage, (pollution 2) 400 V
Max. AC load (Table 1, page 44) 2,5 KVA
Max. DC load See Table 2, page 44

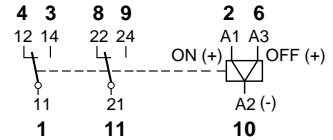

Standard types (50/60 Hz and DC)

AC 24, 48, 115 (110 ... 120), **230**
C3-R20 / ... V

DC 12, 24, 48, 110, 125
(two windings)

C3-R20 / ... V

Note: All AC and DC coils withstand permanent connection.

Specifications

ON pulse power 1,5 VA/ W
OFF pulse power 0,5 VA/ W
Min. pulse length for ON/OFF control 50 ms.
Isolation: EN60947 pollution 3, Gr C 250V
Dielectric strength, contacts / coil 2,5 KV
Dielectric strength, pole / pole 2,5 KV



Table 6 Electrical life (ops x 10⁶)
Types C3-M10 and C5-M10

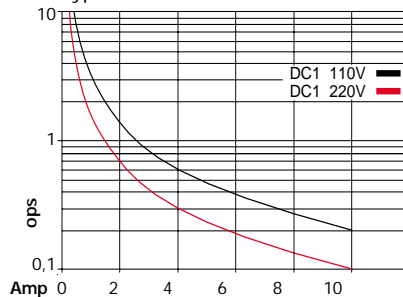
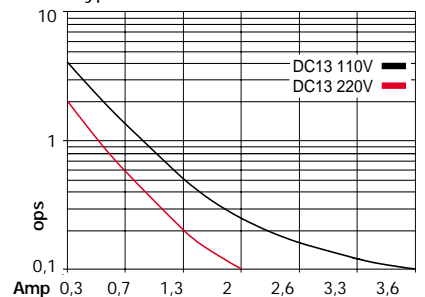

Table 7 Electrical life (ops x 10⁶)
Types C3-M10 and C5-M10





MRC 11 PIN SENSITIVE COIL
(WIDE VOLTAGE TOLERANCE)

- Lockable test button
- Marking label on relay
- Colour coded test button
- Coil voltage marked on top of relay
- Label carries full technical information
- CE marked

C3-S14... Sensitive, 250 mW
One change-over contact, 6 A

Operating range: 0,8 ... 2,5 x Un
6A / 250V AC1 6A @ 30V DC1

Contacts

Materials	code 4 (standard)
Max. switching current	6 A
Peak inrush current (10 ms)	15 A
Max. switching voltage, (pollution 3)	250 V
Max. switching voltage, (pollution 2)	400 V
Max. AC resistive load (Table 8)	1,2 KVA
Max. DC load	See Table 9

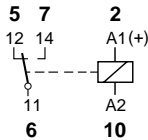

Standard types, DC

DC 6, 12, 24, 48 C3-S14 / ... V

Free wheeling diode C3-S14D / ... V
Free wheeling and polarity C3-S14F / ... V

Note: The connection of diodes to the coil will increase the initial drop-out time.
LED not available

Specifications

Nominal coil power	250 mW
Operate time	18 ms.
Release time	10 ms.
Isolation: EN60947 pollution 3, Gr C	250V
Dielectric strength, contacts / coil	2,5 KV
Dielectric strength, pole / pole	2,5 KV



Dimensions (mm)

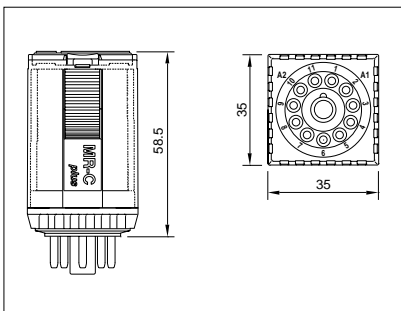

C3-E24... Sensitive, 500 mW
Two change-over contacts, 6 A

Operating range: 0,8 ... 1,7 x Un
6A / 250V AC1 6A @ 30V DC1

Contacts

Materials	code 4 (standard)
Max. switching current	6 A
Peak inrush current (10 ms)	15 A
Max. switching voltage, (pollution 3)	250 V
Max. switching voltage, (pollution 2)	400 V
Max. AC resistive load (Table 8)	1,2 KVA
Max. DC load	See Table 9

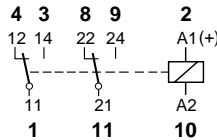

Standard types, DC

DC 6, 12, 24, 48, 60 C3-E24 / ... V

Free wheeling diode C3-E24D / ... V
Free wheeling and polarity C3-E24F / ... V

Note: The connection of diodes to the coil will increase the initial drop-out time.
LED not available

Specifications

Nominal coil power	500 mW
Operate time	18 ms.
Release time	10 ms.
Isolation: EN60947 pollution 3, Gr C	250V
Dielectric strength, contacts / coil	2,5 KV
Dielectric strength, pole / pole	2,5 KV



Table 8 Electrical life (ops x 10⁶)
Types C3-S14, C3-E24, C3-N34

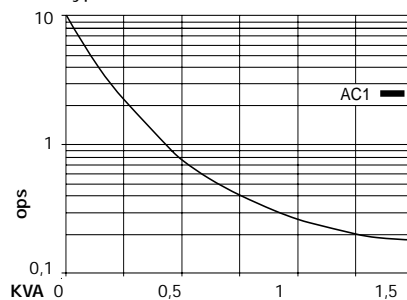

C3-N34... Sensitive, 800 mW
Three change-over contacts, 6 A

Operating range: 0,8 ... 1,4 x Un
6A / 250V AC1 6A @ 30V DC1

Contacts

Materials	code 4 (standard)
Max. switching current	6 A
Peak inrush current (10 ms)	15 A
Max. switching voltage, (pollution 3)	250 V
Max. switching voltage, (pollution 2)	400 V
Max. AC resistive load (Table 8)	1,2 KVA
Max. DC load	See Table 9

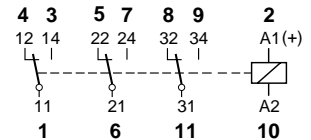

Standard types, DC

DC 6, 12, 24, 48, 60, 110 C3-N34 / ... V

Free wheeling diode C3-N34D / ... V
Free wheeling and polarity C3-N34F / ... V

Note: The connection of diodes to the coil will increase the initial drop-out time.
LED not available

Specifications

Nominal coil power	800 mW
Operate time	18 ms.
Release time	10 ms.
Isolation: EN60947 pollution 3, Gr C	250V
Dielectric strength, contacts / coil	2,5 KV
Dielectric strength, pole / pole	2,5 KV



Table 9 Max. DC load
Types C3-S14, C3-E24, C3-N34

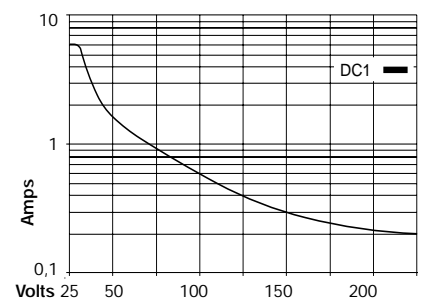



MRC 14 PIN (FLAT BLADE) STANDARD/
POWER/LATCHING

- Lockable test button
- Marking label on relay
- 2 window mechanical flag (not available on C4-X20)
- Colour coded test button
- Coil voltage marked on top of relay
- Label carries full technical information
- CE marked

C4-A40... General purpose
Four change-over contacts, 10 A

10A / 250V AC1 10 A @ 30V DC1
6A / 250V AC15 0,5A @ 110V DC1

Contacts

Materials code 0 (standard); options: 8 - 9
Max. switching current 10 A
Peak inrush current (20 ms) 30 A
Max. switching voltage, (pollution 3) 250 V
Max. switching voltage, (pollution 2) 400 V
Max. AC load (Table 11) 2 KVA
Max. DC load See Table 2, page 44

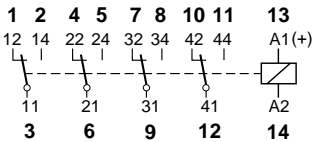

Standard types (50/60 Hz and DC)

AC 24, 48, 115 (110 ... 120), **230**
X = LED (optional) C4-A40 X/ ... V
RC suppressor C4-A40R X/ ... V

DC 12, 24, 48, 110, 120/125, 220
X = LED (optional) C4-A40 X/ ... V
Free wheeling diode C4-A40D X/ ... V
Free wheeling and polarity C4-A40F X/ ... V
AC/DC rectifier (60V max.) C4-A40B X/ ... V

Specifications

Nominal coil power: 2,4 VA (AC), 1,4 W (DC)
Operate time 20 ms.
Release time 8 ms.
Isolation: EN60947 pollution 3, Gr C 250V
Dielectric strength, contacts / coil 2,5 KV
Dielectric strength, pole / pole 2,5 KV

Lloyd's

Dimensions (mm)

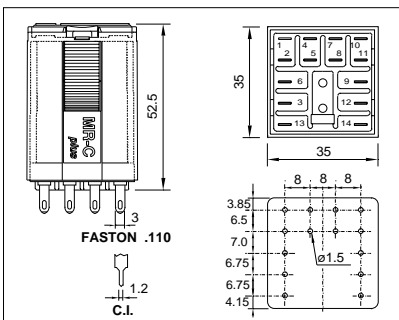

C4-X20... Power relay, DC
Double pole, NO, double make

10A / 250V AC1 1,2A @ 220V DC1
7A @ 110V DC1 0,3A @ 220V DC13

Contacts

Materials code 0 (standard)
Max. switching current 10 A
Peak inrush current (20 ms) 30 A
Max. switching voltage, (pollution 3) 250 V
Max. switching voltage, (pollution 2) 400 V
Max. AC load (Table 11) 2 KVA
Max. DC load See Table 10

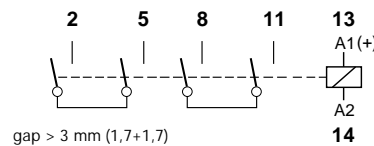

Standard types (50/60 Hz and DC)

AC 24, 48, 115 (110 ... 120), **230**
X = LED (optional) C4-X20 X/ ... V
RC suppressor C4-X20R X/ ... V

DC 12, 24, 48, 110, 120/125, 220
X = LED (optional) C4-X20 X/ ... V
Free wheeling diode C4-X20D X/ ... V
Free wheeling and polarity C4-X20F X/ ... V
AC/DC rectifier (60V max.) C4-X20B X/ ... V

Specifications

Nominal coil power: 2,4 VA (AC), 1,3 W (DC)
Operate time 20 ms.
Release time 8 ms.
Isolation: EN60947 pollution 3, Gr C 250V
Dielectric strength, contacts / coil 2,5 KV
Dielectric strength, pole / pole 2,5 KV



Table 10 Máx. DC load
Type C3-X10, C4-X20

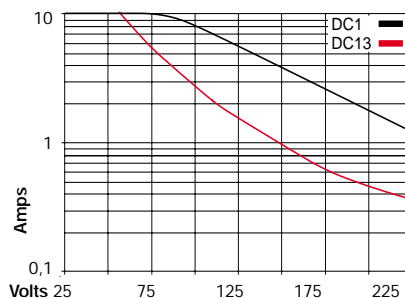

C4-R30... Latching relay
Three change-over contacts, 10 A

10A / 250V AC1 10 A @ 30V DC1
6A / 250V AC15 0,5A @ 110V DC1

Contacts

Materials code 0 (standard); options: 8 - 9
Max. switching current 10 A
Peak inrush current (20 ms) 30 A
Max. switching voltage, (pollution 3) 250 V
Max. switching voltage, (pollution 2) 400 V
Max. AC load (Table 11) 2 KVA
Max. DC load See Table 2, page 44

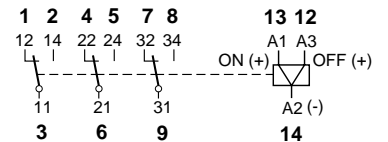

Standard types (50/60 Hz and DC)

AC 24, 48, 115 (110 ... 120), **230**
C4-R30 / ... V

DC 12, 24, 48, 110, 125
Two coils C4-R30 / ... V

Note: All AC and DC coils withstand permanent connection.

Specifications

ON pulse power 1,5 VA/ W
OFF pulse power 0,5 VA/ W
Min. pulse length for ON/OFF control: 50 ms.
Isolation: EN60947 pollution 3, Gr C 250V
Dielectric strength, contacts / coil 2,5 KV
Dielectric strength, pole / pole 2,5 KV



Table 11 Electrical life (ops x 10⁶)
Types C4-A40, C4-X20, C4-R30

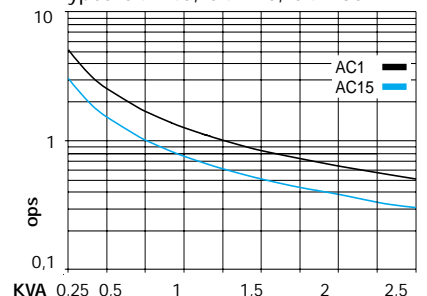



MRC 11 PIN (FLAT BLADE) STANDARD/
OPEN CONTACTS

- Lockable test button
- Marking label on relay and socket
- 2 window mechanical flag (not available on C5-G30)
- Colour coded test button
- Coil voltage marked on top of relay
- Label carries full technical information
- CE marked

C5-A20... General purpose
Two change-over contacts, 16 A

16A / 500V AC1 16A @ 30V DC1
8A / 500V AC15 0,5A @ 110V DC1

Contacts

Materials code 0 (standard); options: 8 - 9
Max. switching current 16 A
Peak inrush current (20 ms) 40 A
Max. switching voltage, (pollution 3) 500
Max. AC load (Table 12) 4 KVA
Max. DC load See Table 13

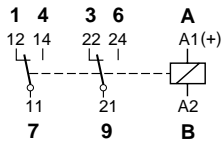

Standard types (50/60 Hz and DC)

AC 24, 48, 115 (110 ... 120), 230, 400
X = LED (optional) C5-A20 X/ ... V
RC suppressor C5-A20R X/ ... V

DC 12, 24, 48, 110, 120/125, 220

X = LED (optional) C5-A20 X/ ... V
Free wheeling diode C5-A20D X/ ... V
Free wheeling and polarity C5-A20F X/ ... V
AC/DC rectifier (60V max.) C5-A20B X/ ... V

Specifications

Nominal coil power: 2,4 VA (AC), 1,4 W (DC)
Operate time 20 ms.
Release time 10 ms.
Isolation: EN60947 pollution 3, Gr C 500 V
Dielectric strength, contacts / coil 4 KV
Dielectric strength, pole / pole 4 KV



Dimensions (mm)

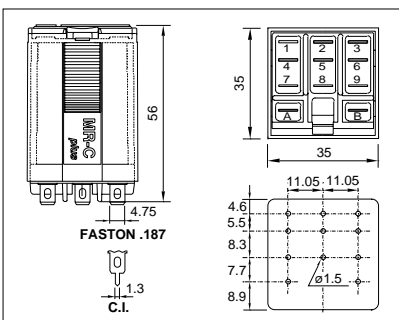

C5-A30... General purpose
Three change-over contacts, 16 A

16A / 500V AC1 16A @ 30V DC1
8A / 500V AC15 0,5A @ 110V DC1

Contacts

Materials code 0 (standard); options: 8 - 9
Max. switching current 16 A
Peak inrush current (20 ms) 40 A
Max. switching voltage, (pollution 3) 500
Max. AC load (Table 12) 4 KVA
Max. DC load See Table 13

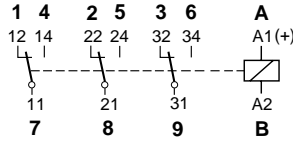

Standard types (50/60 Hz and DC)

AC 24, 48, 115 (110 ... 120), 230, 400
X = LED (optional) C5-A30 X/ ... V
RC suppressor C5-A30R X/ ... V

DC 12, 24, 48, 110, 120/125, 220

X = LED (optional) C5-A30 X/ ... V
Free wheeling diode C5-A30D X/ ... V
Free wheeling and polarity C5-A30F X/ ... V
AC/DC rectifier (60V max.) C5-A30B X/ ... V

Specifications

Nominal coil power: 2,4 VA (AC), 1,4 W (DC)
Operate time 20 ms.
Release time 10 ms.
Isolation: EN60947 pollution 3, Gr C 500 V
Dielectric strength, contacts / coil 4 KV
Dielectric strength, pole / pole 4 KV



Table 12 Electrical life (ops x 10⁶)
Types C5- (A, G, X, M), C7-A10

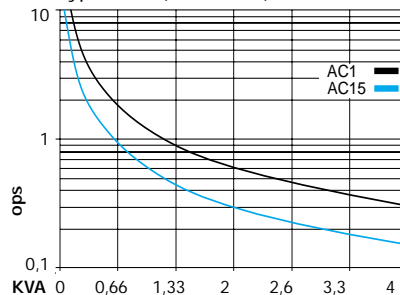

C5-G30... General purpose, DC
Three open contacts

16A / 500V AC1 0,3A @ 110V DC13
1,2A @ 110V DC1 0,4A @ 220V DC1

Contacts

Materials code 0 (standard)
Max. switching current 16 A
Peak inrush current (20 ms) 40 A
Max. switching voltage, (pollution 3) 500 V
Max. AC load (Table 12) 4 KVA
Max. DC load See Table 14, page 50

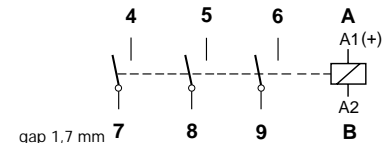

Standard types (50/60 Hz and DC)

AC 24, 48, 115 (110 ... 120), 230, 400
X = LED (optional) C5-G30 X/ ... V
RC suppressor C5-G30R X/ ... V

DC 12, 24, 48, 110, 120/125, 220

X = LED (optional) C5-G30 X/ ... V
Free wheeling diode C5-G30D X/ ... V
Free wheeling and polarity C5-G30F X/ ... V
AC/DC rectifier (60V max.) C5-G30B X/ ... V

Specifications

Nominal coil power: 2,4 VA (AC), 1,6 W (DC)
Operate time 20 ms.
Release time 10 ms.
Isolation: EN60947 pollution 3, Gr C 500 V
Dielectric strength, contacts / coil 4 KV
Dielectric strength, pole / pole 4 KV



Table 13 Max. DC load
Types C5-A20, C5-A30

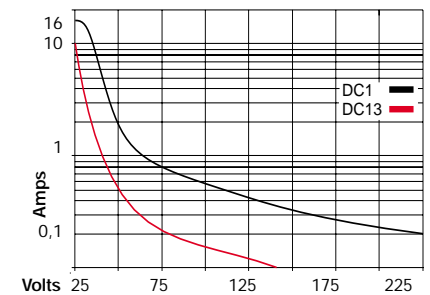



MRC 11 PIN (FLAT BLADE) POWER/
MAGNETIC BLOW-OUT/LATCHING

- Lockable test button
- Marking label on relay
- 2 window mechanical flag (not available on C5-X10 or C5-M10)
- Colour coded test button
- Coil voltage marked on top of relay
- Label carries full technical information
- CE marked

C5-X10... Power relay, DC
Single pole, NO, double make

16A / 500V AC1 1,2A @ 220V DC1
7A @ 110V DC1 0,3A @ 220V DC13

Contacts

Materials code **0** (standard)
Max. switching current 16 A
Peak inrush current (20 ms) 40 A
Max. switching voltage, (pollution 3) 500 V
Max. AC load (Table 12, page 49) 4 KVA
Max. DC load See Table 15

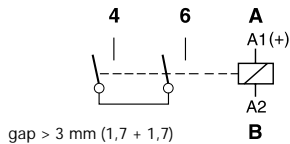

Standard types (50/60 Hz and DC)

AC 24, 48, 115 (110 ... 120), **230, 400**
X = LED (optional) C5-X10 X/ ... V
RC suppressor C5-X10R X/ ... V

DC 12, 24, 48, 110, 120/125, 220

X = LED (optional) C5-X10 X/ ... V
Free wheeling diode C5-X10D X/ ... V
Free wheeling and polarity C5-X10F X/ ... V
AC/DC rectifier (60V max.) C5-X20B X/ ... V

Specifications

Nominal coil power: 2,4 VA (AC), 1,3 W (DC)
Operate time 20 ms.
Release time 10 ms.
Isolation: EN60947 pollution 3, Gr C 500V
Dielectric strength, contacts / coil 4 KV
Weight avg. 90 grs.



Table 14 Max. DC load
Type C5-G30

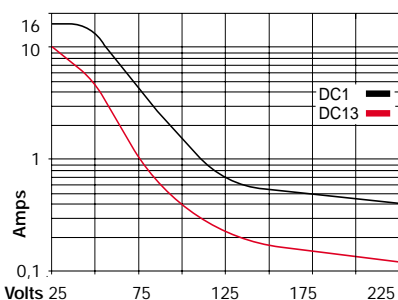

C5-M10... Power relay, DC
SP double make. Magnetic blow out

16A / 500V AC1 10A @ 220V DC1
3,6A @ 110V DC13 2A @ 220V DC13

Contacts

Materials code **0** (standard)
Max. switching current 16 A
Peak inrush current (20 ms) 40 A
Max. switching voltage, (pollution 3) 500 V
Max. AC load (Table 12, page 49) 4 KVA
Electrical life, DC See Tables 6 and 7, page 46

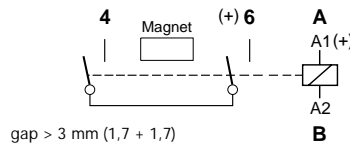

Standard types (50/60 Hz and DC)

AC 24, 48, 115 (110 ... 120), **230, 400**
X = LED (optional) C5-M10 X/ ... V
RC suppressor C5-M10R X/ ... V

DC 12, 24, 48, 110, 120/125, 220

X = LED (optional) C5-M10 X/ ... V
Free wheeling diode C5-M10D X/ ... V
Free wheeling and polarity C5-M10F X/ ... V
AC/DC rectifier (60V max.) C5-M20B X/ ... V

Specifications

Nominal coil power: 2,4 VA (AC), 1,3 W (DC)
Operate time 20 ms.
Release time 10 ms.
Isolation: EN60947 pollution 3, Gr C 500V
Dielectric strength, contacts / coil 4 KV
Weight avg. 90 grs.

C5-R20... Latching relay
Two change-over contacts, 10 A

10A / 500V AC1 10A @ 30V DC1
6A / 500V AC15 0,5A @ 110V DC1

Contacts

Materials code **0** (standard)
Max. switching current 10 A
Peak inrush current (20 ms) 30 A
Max. switching voltage, (pollution 3) 500 V
Max. AC load (Table 1, page 44) 2,5 KVA
Max. DC load See Table 2, page 44

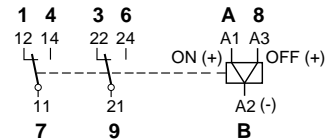

Standard types (50/60 Hz and DC)

AC 24, 48, 115 (110 ... 120), **230**
C5-R20 / ... V

DC 12, 24, 48, 110, 125
(two windings)

C5-R20 / ... V

Note: All AC and DC coils withstand permanent connection.

Specifications

ON pulse power 1,5 VA/ W
OFF pulse power 0,5 VA/ W
Min. pulse length for ON/OFF control 50 ms.
Isolation: EN60947 pollution 3, Gr C 500V
Dielectric strength, contacts / coil 4 KV
Dielectric strength, pole / pole 4 KV



Table 16 Max. DC load
Type C7-A10

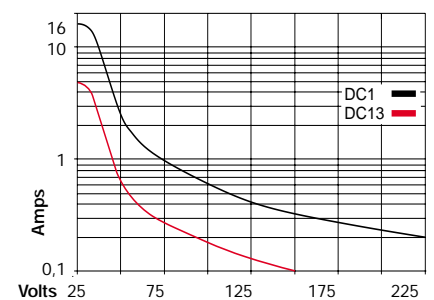



QRC 8 PIN MINIATURE STANDARD/LOW SIGNAL LEVEL

- Lockable test button
- Marking label on relay
- 2 window mechanical flag
- Colour coded test button
- Coil voltage marked on top of relay
- Label carries full technical information
- CE marked

C7-A20... General purpose
Two change-over contacts, 10 A

10A / 250V AC1 10A @ 30V DC1
6A / 250V AC15 0,5A @ 110V DC1

Contacts

Materials code 0 (standard); options: 8 - 9
Max. switching current 10 A
Peak inrush current (20 ms) 30 A
Max. switching voltage, (pollution 3) 250 V
Max. switching voltage, (pollution 2) 400 V
Max. AC load (Table 17) 2,5 KVA
Max. DC load See Table 2, page 44

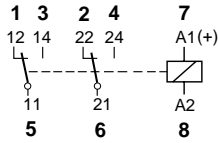

Standard types (50/60 Hz and DC)

AC 24, 48, 115 (110 ... 120), 230
X = LED (optional) C7-A20 X/ ... V

DC 12, 24, 48, 110, 120/125, 220
X = LED (optional) C7-A20 X/ ... V
Free wheeling diode C7-A20D X/ ... V
Free wheeling and polarity C7-A20F X/ ... V
AC/DC rectifier (60V max.) C7-A20B X/ ... V

Specifications

Nominal coil power: 1,5 VA (AC), 1 W (DC)
Operate time 16 ms.
Release time 8 ms.
Isolation: EN60947 pollution 3, Gr C 250V
Dielectric strength, contacts / coil 2,5 KV
Dielectric strength, pole / pole 2,5 KV
Weight avg. 43 grs.



Dimensions (mm)

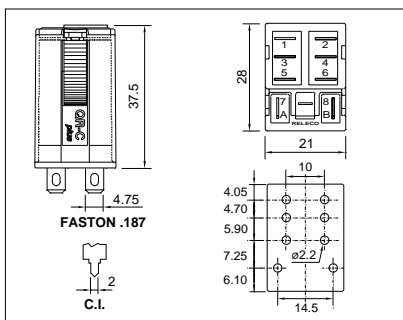

C7-T21... Low level
Two change-over, bifurcated contacts

6A / 250V AC1 6A @ 30V DC1
Min. 5mA @ DC 5V

Contacts

Materials code 1 (standard); option: 2
Switching current: min. 5 mA; max. 6 A
Peak inrush current (5 ms) 15 A
Max. switching voltage, (pollution 3) 250 V
Max. switching voltage, (pollution 2) 400 V
Max. AC load (Table 3, page 45) 1,2 KVA
Max. DC load See Table 18

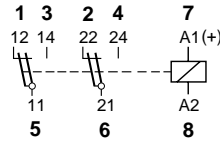

Standard types (50/60 Hz and DC)

AC 24, 48, 115 (110 ... 120), 230
X = LED (optional) C7-T21 X/ ... V

DC 12, 24, 48, 110, 120/125, 220
X = LED (optional) C7-T21 X/ ... V
Free wheeling diode C7-T21D X/ ... V
Free wheeling and polarity C7-T21F X/ ... V
AC/DC rectifier (60V max.) C7-T21B X/ ... V

Specifications

Nominal coil power: 1,5 VA (AC), 1 W (DC)
Operate time 16 ms.
Release time 8 ms.
Isolation: EN60947 pollution 3, Gr C 250V
Dielectric strength, contacts / coil 2,5 KV
Dielectric strength, pole / pole 2,5 KV
Weight avg. 43 grs.



Table 17 Electrical life (ops x 10⁶)
Types C7-A20, C7-G20, C7-X, C7-W

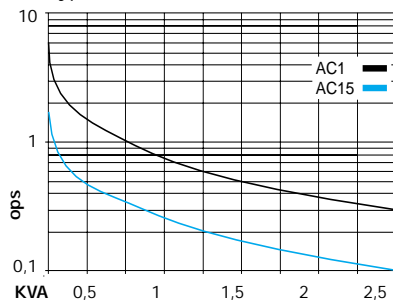

C7-A10... General purpose
One change-over contact, 16 A

16A / 250V AC1 16A @ 30V DC1
8A / 250V AC15 0,5A @ 110V DC1

Contacts

Materials code 0 (standard)
Max. switching current 16 A
Peak inrush current (20 ms) 40 A
Max. switching voltage, (pollution 3) 250 V
Max. switching voltage, (pollution 2) 400 V
Max. AC load (Table 12, page 49) 4 KVA
Max. DC load See Table 16, page 50

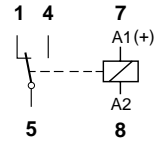

Standard types (50/60 Hz and DC)

AC 24, 48, 115 (110 ... 120), 230
X = LED (optional) C7-A10 X/ ... V

DC 12, 24, 48, 110, 120/125
X = LED (optional) C7-A10 X/ ... V
Free wheeling diode C7-A10D X/ ... V
Free wheeling and polarity C7-A10F X/ ... V
AC/DC rectifier (60V max.) C7-A10B X/ ... V

Specifications

Nominal coil power: 1,8 VA (AC), 1,5 W (DC)
Operate time 16 ms.
Release time 8 ms.
Isolation: EN60947 pollution 3, Gr C 250V
Dielectric strength, contacts / coil 2,5 KV
Weight avg. 43 grs.

Table 18 Max. DC load
Types C2-T21, C3-T31, C7-T21

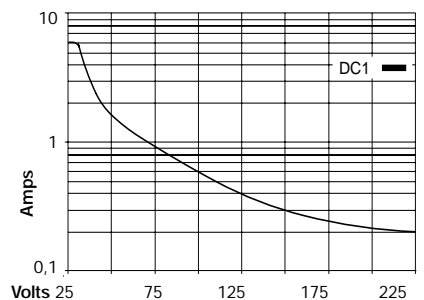



QRC 8 PIN MINIATURE OPEN CONTACTS/
POWER/HIGH INRUSH CURRENT

- Lockable test button
- Marking label on relay
- 2 window mechanical flag (not available on C7-G20 or C7-X10)
- Colour coded test button
- Coil voltage marked on top of relay
- Label carries full technical information
- CE marked

C7-G20... Power relay, DC
Two open contacts, gap 1,5 mm

10A / 250V AC1 0,8A @ 110V DC1
0,4A @ 220V DC1 0,3A @ 110V DC13

Contacts

Materials code 0 (standard)
Max. switching current 10 A
Peak inrush current (20 ms) 30 A
Max. switching voltage, (pollution 3) 250 V
Max. switching voltage, (pollution 2) 400 V
V Max. AC load (Table 17, page 51) 2,5 KVA
Max. DC load See Table 19

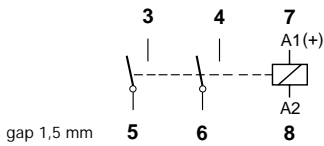

Standard types (50/60 Hz and DC)

AC 24, 48, 115 (110 ... 120), 230
X = LED (optional) C7-G20 X/ ... V

DC 12, 24, 48, 110, 120/125
X = LED (optional) C7-G20 X/ ... V
Free wheeling diode C7-G20D X/ ... V
Free wheeling and polarity C7-G20F X/ ... V
AC/DC rectifier (60V max.) C7-G20B X/ ... V

Specifications

Nominal coil power: 1,8 VA (AC), 1,5 W (DC)
Operate time 20 ms.
Release time 10 ms.
Isolation: EN60947 pollution 3, Gr C 250V
Dielectric strength, contacts / coil 2,5 KV
Dielectric strength, pole / pole 2,5 KV
Weight avg. 43 grs.

C7-X10... Power relay, DC
Single pole, NO, double make

10A / 250V AC1 1A @ 220V DC1
6A @ 110V DC1 0,3A @ 220V DC13

Contacts

Materials code 0 (standard)
Max. switching current 10 A
Peak inrush current (20 ms) 30 A
Max. switching voltage, (pollution 3) 250 V
Max. switching voltage, (pollution 2) 400V
V Max. AC load (Table 17, page 51) 2,5 KVA
Max. DC load See Table 20

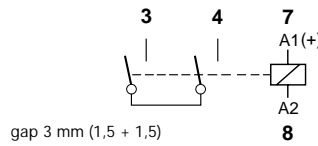

Standard types (50/60 Hz and DC)

AC 24, 48, 115 (110 ... 120), 230
X = LED (optional) C7-X10 X/ ... V

DC 12, 24, 48, 110, 120/125
X = LED (optional) C7-X10 X/ ... V
Free wheeling diode C7-X10D X/ ... V
Free wheeling and polarity C7-X10F X/ ... V
AC/DC rectifier (60V max.) C7-X10B X/ ... V

Specifications

Nominal coil power: 1,8 VA (AC), 1,3 W (DC)
Operate time 20 ms.
Release time 10 ms.
Isolation: EN60947 pollution 3, Gr C 250V
Dielectric strength, contacts / coil 2,5 KV
Weight avg. 43 grs.

C7-W10... High inrush current
Single pole, two contacts in parallel
wolfram and silver

10A / 250V AC15 6A @ 250V AC5a/b

Contacts

Materials code 0 (standard)
Max. switching current 10 A
Peak inrush current (2,5 ms) 500 A
Max. switching voltage, (pollution 3) 250 V
Max. switching voltage, (pollution 2) 400 V
V Max. AC load (Table 17, page 51) 2,5 KVA
Electrical life, AC5 a/b (lamps) See Table 21

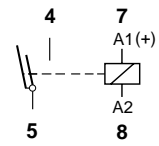

Standard types (50/60 Hz and DC)

AC 24, 48, 115 (110 ... 120), 230
X = LED (optional) C7-W10 X/ ... V

DC 12, 24, 48, 110, 120/125
X = LED (optional) C7-W10 X/ ... V
Free wheeling diode C7-W10D X/ ... V
Free wheeling and polarity C7-W10F X/ ... V
AC/DC rectifier (60V max.) C7-W10B X/ ... V

Specifications

Nominal coil power: 1,8 VA (AC), 1,3 W (DC)
Operate time 20 ms.
Release time 10 ms.
Isolation: EN60947 pollution 3, Gr C 250V
Dielectric strength, contacts / coil 2,5 KV
Weight avg. 43 grs.

Table 19 Max. DC load
Type C7-G20

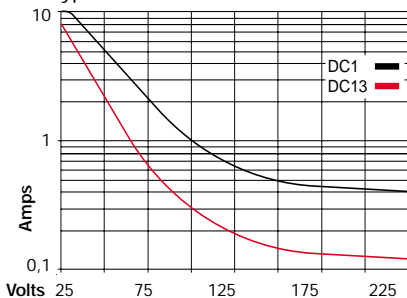

Table 20 Max. DC load
Type C7-X10

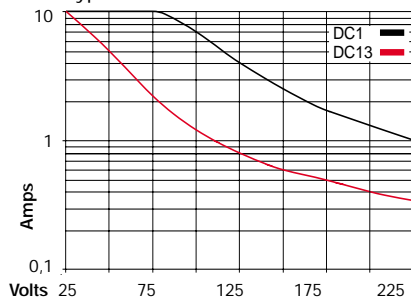
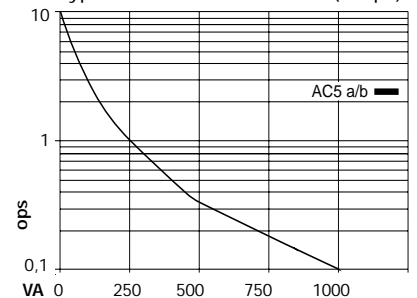

Table 21 Electrical life (ops x 10⁶)
Type C7-W10 AC5a/b (lamps)





QRC 14 PIN MINIATURE STANDARD/
SENSITIVE COIL / LATCHING

- Lockable test button
- Marking label on relay
- 2 window mechanical flag (not available on C9-E21)
- Colour coded test button
- Coil voltage marked on top of relay
- Label carries full technical information
- CE marked

C9-A41... General purpose
Four change-over contacts, 3 A

3A / 250V AC1 3A @ 30V DC1
1A / 250V AC15 0,2A @ 110V DC1

Contacts

Materials code 1 (standard); options: 2 - 9
Max. switching current 3 A
Peak inrush current (10 ms) 15 A
Max. switching voltage, (pollution 2) 150 V
Max. AC resistive load (Table 22) 0,7 KVA
Max. DC load See Table 23

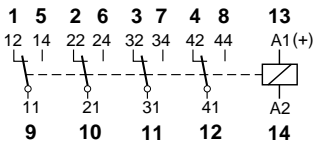

Standard types (50/60 Hz and DC)

AC 24, 48, 115 (110 ... 120), 230
X = LED (optional) C9-A41 X/ ... V

DC 12, 24, 48, 110, 120/125, 220
X = LED (optional) C9-A41 X/ ... V
Free wheeling diode C9-A41D X/ ... V
Free wheeling and polarity C9-A41F X/ ... V
AC/DC rectifier (60V max.) C9-A41B X/ ... V

Specifications

Nominal coil power: 1,5 VA (AC), 1 W (DC)
Operate time 10 ms.
Release time 6 ms.
Isolation: EN60947 pollution 2 150V
Dielectric strength, contacts / coil 2,5 KV
Dielectric strength, pole / pole 1 KV
Weight avg. 43 grs.



Dimensions (mm)

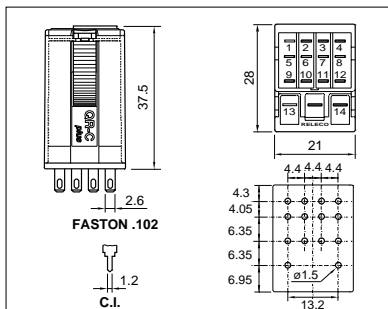

C9-E21... Sensitive, 500 mW
Two change-over contacts, 3 A

Operating range: 0,8 ... 1,7 x Un
3A / 250V AC1 3A @ 30V DC1

Contacts

Materials code 1 (standard); options: 2 - 9
Max. switching current 3 A
Peak inrush current (10 ms) 15 A
Max. switching voltage, (pollution 3) 250 V
Max. AC resistive load (Table 22) 0,7 KVA
Max. DC load See Table 23

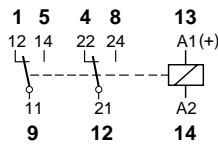

Standard types (50/60 Hz and DC)

AC 24, 48, 115 (110 ... 120), 230
X = LED (optional) C9-E21 X/ ... V

DC 12, 24, 48, 110, 120/125, 220
X = LED (optional) C9-E21 X/ ... V
Free wheeling diode C9-E21D X/ ... V
Free wheeling and polarity C9-E21F X/ ... V
AC/DC rectifier (60V max.) C9-E21B X/ ... V

Specifications

Nominal coil power: 1 VA (AC), 500 mW (DC)
Operate time 10 ms.
Release time 6 ms.
Isolation: EN60947 pollution 3, Gr C 250V
Dielectric strength, contacts / coil 2,5 KV
Dielectric strength, pole / pole 2,5 KV
Note: Specifications valid without LED or diodes

Lloyd's

Table 22 Electrical life (ops x 10⁶)
Types C9-A41, C9-E21, C9-R21

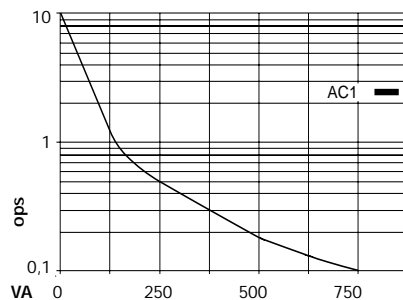

C9-R21... Latching
Two change-over contacts, 3 A

3A / 250V AC1 3A @ 30V DC1
1A / 250V AC15 0,2A @ 110V DC1

Contacts

Materials code 1 (standard)
Max. switching current 3 A
Peak inrush current (10 ms) 15 A
Max. switching voltage, (pollution 3) 250 V
Max. AC resistive load (Table 22) 0,7 KVA
Max. DC load See Table 23

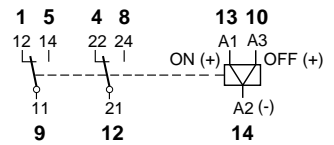

Standard types (50/60 Hz and DC)

AC 24, 48, 115 (110 ... 120), 230
C9-R20 / ... V

DC 12, 24, 48, 60
(two windings) C9-R20 / ... V

Note: All AC and DC coils withstand permanent connection

Specifications

ON pulse power 1,2 VA/ W
OFF pulse power 0,3 VA/ W
Min. pulse length for ON/OFF control 50 ms.
Isolation: EN60947 pollution 3, Gr C 250V
Dielectric strength, contacts / coil 2,5 KV
Dielectric strength, pole / pole 2,5 KV
Weight avg. 43 grs.

Table 23 Max. DC load
Types C9-A41, C9-E21, C9-R21

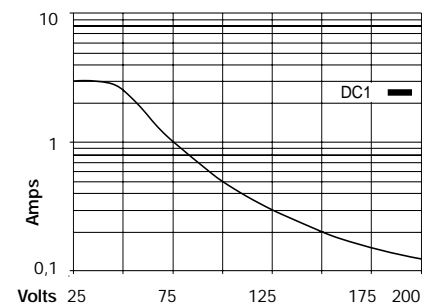



IRC SINGLE POLE STANDARD/
LOW SIGNAL LEVEL

- LED Indication as standard (except with RC suppression)
- Colour coded lockable test button
- Marking label on relay
- 4.75mm flat blade terminals
- Coil voltage marked on top of relay
- Gold plate option (C10-A18X and C10-T12X)

- BX version — one type fits all!
 - 24VDC
 - 24VAC
 - Not polarity conscious
 - Free wheeling diode (VDC)
 - RC suppression (VAC)

GENERAL INFORMATION

Electrical and Mechanical Life

100.000 operations at full rated load 20 x 10⁶ mechanical operations measured at 6.000 ops/hour (see table 1).

Temperatures

Operating and storage temperatures are respectively -20°C...+60°C and -20°C...+100°C.

Coil

The temperature rise in the coil when permanently energised, at nominal voltage, is 45°C max. at AC and 35°C max. at DC.

All coils are calculated to withstand a permanent connection at maximum ambient temperature of 60°C and 10% above the nominal voltage.

The coil inrush power of AC coils is approx. 1,3 x nominal power.

Vac/dc	Ω ± 10%	mA	Vdc	Ω ± 10%	mA	Vac	Ω ± 10%	mA
24	773	31	5	45	111	24	Use 24Vac/dc*	
48	3K5	13	12	224	53	115	7K1	8,7
			24	773	31	230	28K3	4,3
			110	19K9	5,5			

All values (LED included) measured at U_N with an ambient temperature of 20°C.

* 24Vac and any other coil values, as well as special coils, are available upon request.

Pull-in voltages

DC and AC/DC relays: 0,75 x U_N

AC relays: 0,75 x U_N (at 50 and 60Hz)

Drop-out voltages

DC and AC/DC relays: 0,15 x U_N

AC relays: 0,35 x U_N (at 50 and 60Hz)

Diagrams of additions to the coil

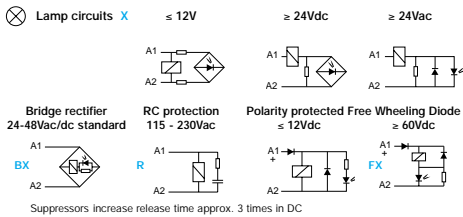

LED & protection circuits available

Voltage	X	BX	FX	R
AC 6 ... 12	●			
AC 24 ... 48	●	●		
AC 115 ... 230	●			●
DC 5 ... 12	●		●	
DC 24 ... 48	●	●		
DC 60 ... 110	●		●	

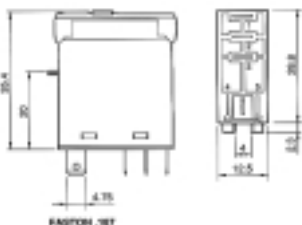

C10-A10X...

Single pole relay, 10A

10A / 400V AC1	10 A @ 30V DC1
6A / 400V AC15	0,5A @ 110V DC1

Contacts

Standard material	AgNi
Optional material	code 8 - AgNi + 10µ Au
Max. switching current	10 A
Peak inrush current (10 ms)	30 A
Max. switching voltage, (pollution 3)	250 V
Max. switching voltage, (pollution 2)	400 V
Max. AC resistive load (table 1)	2,5 KVA
Max. DC load	(table 2)

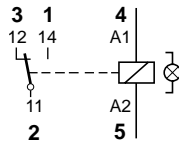

⊗ For lamp, see appropriate diagram

Standard types (50/60 Hz and DC)

- AC/DC 24, 48
- AC 115, 230
- DC 5, 12, 24, 48, 110
- X = LED (standard)
- AC/DC rectifier (48V max.)
- FWD - polarity protected
- RC protection (no LED)

Specifications

Coil power including LED	1,1 VA, 0,65 W
Operate time + bounce time	10 + 1 ms
Release time + bounce time	5 + 3 ms
Isolation: EN60947 pollution 3, Gr C	250 V
Dielectric strength, contact / coil	8 mm / 5 KV
Weight avg.	21 grs.

C10-T13X...

low level

Single pole relay, bifurcated contact

6A / 400V AC1	6A @ 30V DC1
Min. 1mA @ DC 5V	

Contacts

Standard material	code 3 - AgNi + 3µ Au
Optional material	code 2 - AgNi + 10µ Au
Switching current	min. 1 mA; max. 6 A
Peak inrush current (5 ms)	15 A
Max. switching voltage, (pollution 3)	250 V
Max. switching voltage, (pollution 2)	400 V
Max. AC resistive load	1,5 KVA
Max. DC load @ 24 V	6 A

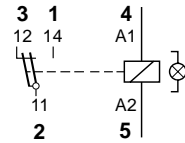

⊗ For lamp, see appropriate diagram

Standard types (50/60 Hz and DC)

- AC/DC 24, 48
- AC 115, 230
- DC 5, 12, 24, 48, 110
- X = LED (standard)
- AC/DC rectifier (48V max.)
- FWD - polarity protected
- RC protection (no LED)

Specifications

Coil power including LED	1,1 VA, 0,65 W
Operate time + bounce time	10 + 1 ms
Release time + bounce time	5 + 3 ms
Isolation: EN60947 pollution 3, Gr C	250 V
Dielectric strength, contact / coil	8 mm / 5 KV
Weight avg.	21 grs.



Table 1: C10-A10X Electrical life (ops. x 10⁶)

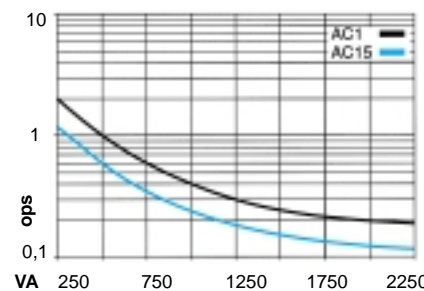
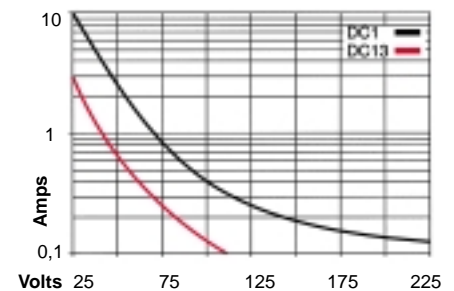
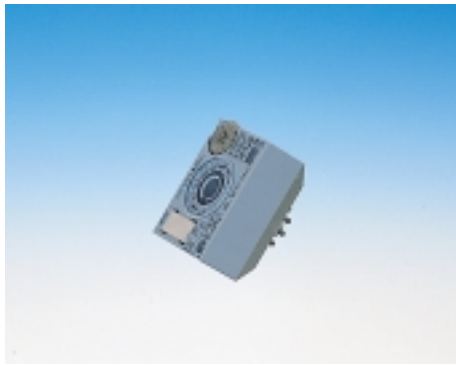

Table 2: C10-T13X Max. DC load





TIME CUBES

- Fits between socket and relay
- Converts relay to timer relay
- On delay, off delay, blinker, one shot and interval functions
- Accepts standard C2 or C3 relays
- Multi time range

CT2A CT3A Off delay	CT2B CT3B Blinker	CT2E CT3E On delay	CT2K CT3K One shot, aux. pulse	CT2W CT3W One shot
The timing starts when S is switched off. The relay drops out at time (t)	The relay blinks ON/OFF at time (t) when switch S is closed. First pulse, ON	The timing starts when the switch S is closed. The relay pulls in at the time (t)	The relay turns ON with a pulse on the switch S and turns OFF at the time (t)	The relay turns ON as switch S is closed and turns OFF at the time (t)

CT2... (8 pin) and CT3... (11 pin) types with time range from 0,2 seconds to 12 minutes (range 20)

CT2-A20/S	9,5 ... 18 V	CT2-B20/S	9,5 ... 18 V	CT2-E20/S	9,5 ... 18 V	CT2-K20/S	9,5 ... 18 V	CT2-W20/S	9,5 ... 18 V
CT2-A20/L	20 ... 65 V	CT2-B20/L	20 ... 65 V	CT2-E20/L	20 ... 65 V	CT2-K20/L	20 ... 65 V	CT2-W20/L	20 ... 65 V
CT2-A20/M	90 ... 150 V	CT2-B20/H	90 ... 265 V	CT2-E20/H	90 ... 265 V	CT2-K20/M	90 ... 150 V	CT2-W20/H	90 ... 265 V
CT2-A20/U	180 ... 265 V					CT2-K20/U	180 ... 265 V		
CT3-A20/S	9,5 ... 18 V	CT3-B20/S	9,5 ... 18 V	CT3-E20/S	9,5 ... 18 V	CT3-K20/S	9,5 ... 18 V	CT3-W20/S	9,5 ... 18 V
CT3-A20/L	20 ... 65 V	CT3-B20/L	20 ... 65 V	CT3-E20/L	20 ... 65 V	CT3-K20/L	20 ... 65 V	CT3-W20/L	20 ... 65 V
CT3-A20/M	90 ... 150 V	CT3-B20/H	90 ... 265 V	CT3-E20/H	90 ... 265 V	CT3-K20/M	90 ... 150 V	CT3-W20/H	90 ... 265 V
CT3-A20/U	180 ... 265 V					CT3-K20/U	180 ... 265 V		

CT2... (8 pin) and CT3... (11 pin) types with time range from 0,8 seconds to 30 minutes (range 25)

CT2-A25/S	9,5 ... 18 V	CT2-E25/S	9,5 ... 18 V	CT2-K25/S	9,5 ... 18 V	CT2-W25/S	9,5 ... 18 V
CT2-A25/L	20 ... 65 V	CT2-E25/L	20 ... 65 V	CT2-K25/L	20 ... 65 V	CT2-W25/L	20 ... 65 V
CT2-A25/M	90 ... 150 V	CT2-E25/H	90 ... 265 V	CT2-K25/M	90 ... 150 V	CT2-W25/H	90 ... 265 V
CT2-A25/U	180 ... 265 V			CT2-K25/U	180 ... 265 V		
CT3-A25/S	9,5 ... 18 V	CT3-E25/S	9,5 ... 18 V	CT3-K25/S	9,5 ... 18 V	CT3-W25/S	9,5 ... 18 V
CT3-A25/L	20 ... 65 V	CT3-E25/L	20 ... 65 V	CT3-K250/L	20 ... 65 V	CT3-W25/L	20 ... 65 V
CT3-A25/M	90 ... 150 V	CT3-E25/H	90 ... 265 V	CT3-K25/M	90 ... 150 V	CT3-W25/H	90 ... 265 V
CT3-A25/U	180 ... 265 V			CT3-K25/U	180 ... 265 V		

Specifications

Time accuracy: + 0,5% / 20 ms.
 Repetition 1 ms / volt.
 Supply voltage 1 ms / volt.
 Ambient temperature -0,25% / K
 Reset time (types E, W, B) < 150 ms.
 Reset time (types A, K) < 200 ms.
 Triggering time: AC, 80 ms ; DC, 50 ms.
 Ambient temperature -10°C ... +60°C
 Transient protection IEC 255.4
 Housing material: Noryl SE1 (UL94V-1)
 Protection class (DIN 40050) IP40
 Weight avg. 35 grs.

Time range setting

Range 20	Range 25
0,2- 3 s	0,8- 8 s
0,8- 12 s	3 - 30 s
0,1-1,5 min	0,4- 4 min
0,8-12 min	3 -30 min

Dip - Sw



10 A / 380 V

Dimensions

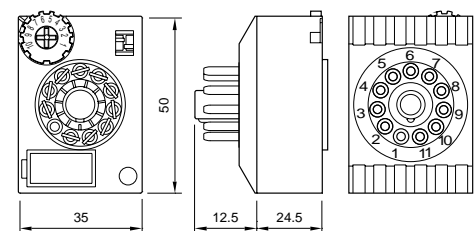



SOCKETS FOR C2 RELAYS

- Built in retaining clip
- Removable label marking facility
- Coding ring compatible
- One or two level terminals
- DIN rail, solder tag or PCB mount

S2-B One level.
Integrated clip and marking label

Accepts the exclusive Releco coding ring for coding both the relay and base. DIN rail or panel mountable. Removable label. EN/DIN and sequential numbering. According to EN60947

Wiring diagram

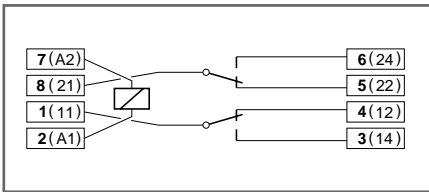

Specifications

Nominal load 10A / 300V
 Dielectric strength (adjacent screws) 2,5 KV
 Dielectric strength (screws / rail) 2,5 KV
 Max. screw torque 1,2 Nm
 Screw dimensions M3, Pozi
 Wire in-lets capacity:
 Solid wire 4 mm² or 2 x 2,25 mm²
 Multi-core 22 - 14 AWG

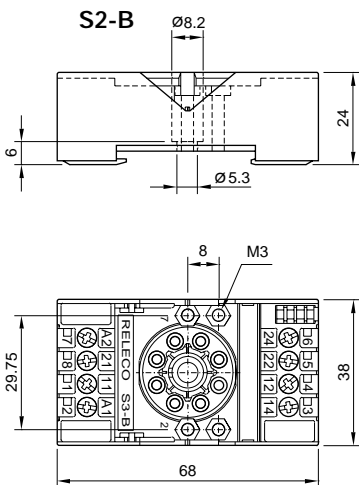

S2-S Two level.
Integrated clip and marking label

Accepts the exclusive Releco coding ring for coding both the relay and base. DIN rail or panel mountable. Removable label. EN/DIN and sequential numbering. According to EN60947

Wiring diagram

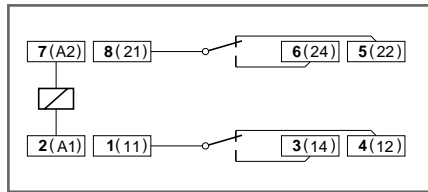

Specifications

Nominal load 10A / 300V
 Dielectric strength (adjacent screws) 2,5 KV
 Dielectric strength (screws / rail) 2,5 KV
 Max. screw torque 1,2 Nm
 Screw dimensions M3, Pozi
 Wire in-lets capacity:
 Solid wire 4 mm² or 2 x 2,25 mm²
 Multi-core 22 - 14 AWG

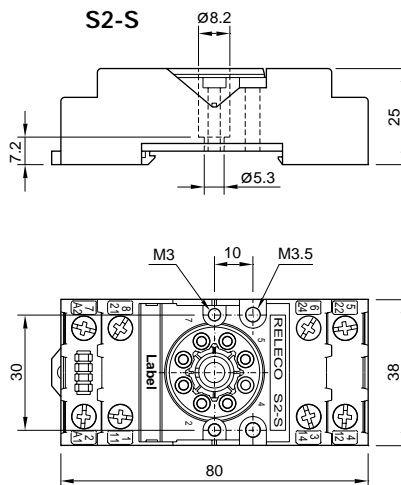

S2-L **S2-PO**
8 pin, solder and printed circuit tags

S2-L Flange panel mountable.

S2-PO Printed circuit tags with flange.

Printed circuit lay-out

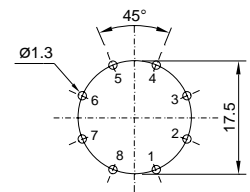

Specifications

Nominal load 10 A / 300 V
 Dielectric strength (adjacent pin) 2,5 KV
 Hard brass, tin-plated terminals

S2-L **S2-PO**

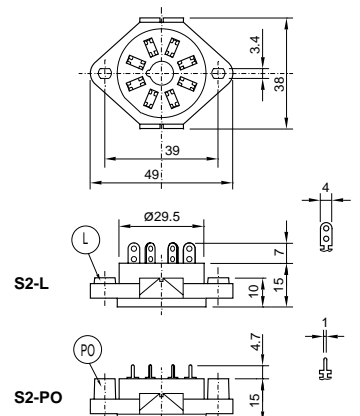

S2-BC Coding Ring

Can be used to code a specific relay to fit a specific socket up to 8 combinations. Supplied in a pack of 5 pieces.



SOCKETS FOR C3 RELAYS

- Built in retaining clip
- Removable label marking facility
- Coding ring compatible
- One or two level terminals
- DIN rail, solder tag or PCB mount

S3-B One level.
Integrated clip and marking label

Accepts the exclusive Releco coding ring for coding both the relay and base. DIN rail or panel mountable. Removable label. EN/DIN and sequential numbering. According to EN60947

Wiring diagram

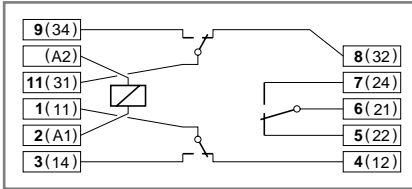

Specifications

Nominal load 10A / 250V
 Dielectric strength (adjacent screws) 2,5 KV
 Dielectric strength (screws / rail) 2,5 KV
 Max. screw torque 1,2 Nm
 Screw dimensions M3, Pozi
 Wire in-lets capacity:
 Solid wire 4 mm² or 2 x 2,25 mm²
 Multi-core 22 - 14 AWG

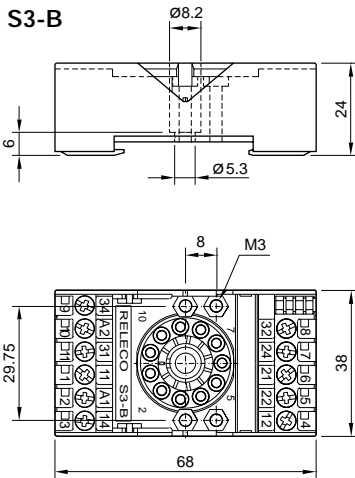

S3-BC Coding Ring

Can be used to code a specific relay to fit a specific socket up to 11 combinations. Supplied in a pack of 5 pieces.

S3-S Two level.
Integrated clip and marking label

Accepts the exclusive Releco coding ring for coding both the relay and base. DIN rail or panel mountable. Removable label. EN/DIN and sequential numbering. According to EN60947

Wiring diagram

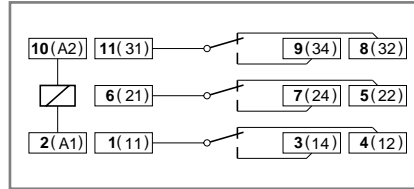

Specifications

Nominal load 10A / 250V
 Dielectric strength (adjacent screws) 2,5 KV
 Dielectric strength (screws / rail) 2,5 KV
 Max. screw torque 1,2 Nm
 Screw dimensions M3, Pozi
 Wire in-lets capacity:
 Solid wire 4 mm² or 2 x 2,25 mm²
 Multi-core 22 - 14 AWG

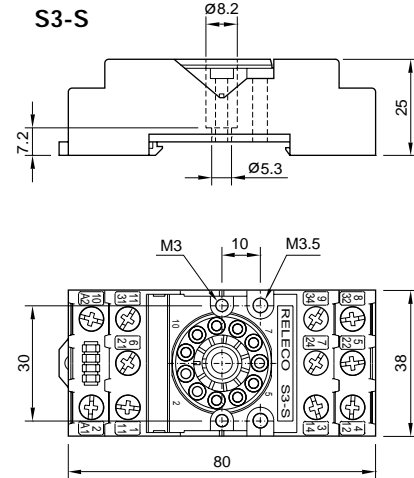
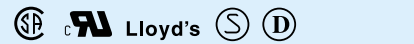

S3-L **S3-PO**
8 pin, solder and printed circuit tags

- S3-L** Flange panel mountable.
- S3-PO** Printed circuit tags with flange.

Printed circuit lay-out

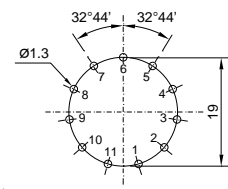

Specifications

Nominal load 10 A / 250 V
 Dielectric strength (adjacent pin) 2,5 KV
 Hard brass, tin-plated terminals

S3-L **S3-PO**

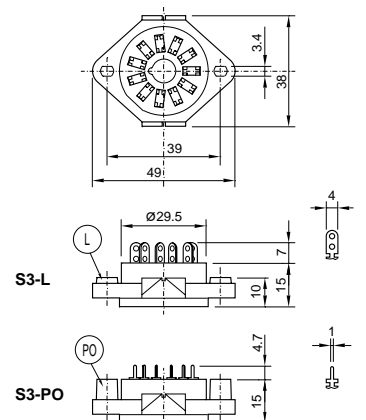



MODULE SOCKETS & MODULES FOR C3 RELAYS



- Built in retaining clip
- Removable label marking facility
- Logical wiring
- In line single level terminals
- Accepts serial and parallel modules

S3-MP One level, screws in line
Logic wiring and Modules

Accepts the plug-in modules **M3P** in parallel with the relay coil.
Integrated hold-down clip and removable marking label. DIN rail or panel mountable. EN/DIN and sequential numbering.

Wiring diagram

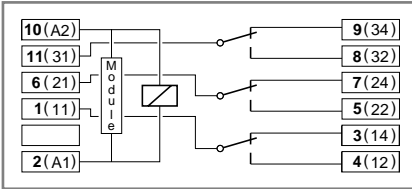

Specifications

Nominal load 10 A / 250 V
Dielectric strength (adjacent screws) 2,5 KV
Dielectric strength (screws / rail) 2,5 KV
Max. screw torque 1,2 Nm
Screw dimensions M3, Pozi
Wire in-lets capacity:
Solid wire 4 mm² or 2 x 2,25 mm²
Multi-core 22 - 14 AWG

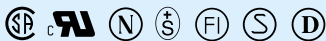

S3-MS One level, screws in line
Logic wiring and Modules

Accepts the plug-in modules **M3S** in series with the coil and **M3P** in parallel.
Integrated hold-down clip and removable marking label. DIN rail or panel mountable. EN/DIN and sequential numbering.

Wiring diagram

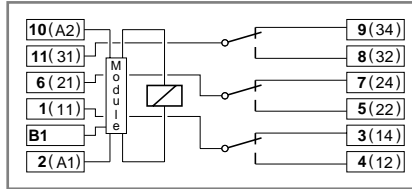

Specifications

Nominal load 10 A / 250 V
Dielectric strength (adjacent screws) 2,5 KV
Dielectric strength (screws / rail) 2,5 KV
Max. screw torque 1,2 Nm
Screw dimensions M3, Pozi
Wire in-lets capacity:
Solid wire 4 mm² or 2 x 2,25 mm²
Multi-core 22 - 14 AWG



M3P Plug in modules for S3-MP

In parallel with the coil

Signaling LED

M3P-X / 24 Vac/dc
M3P-X / 48 Vac/dc
M3P-X / 110 ... 125 Vac/dc
M3P-X / 200 ... 230 Vac/dc

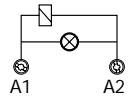

Free wheeling diode

M3P-DL / 12 ... 60 Vdc
M3P-DH / 12 ... 250 Vdc

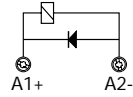

Free wheeling diode and LED

M3P-DX / 24 Vdc
M3P-DX / 48 Vdc
M3P-DX / 110 ... 125 Vdc
M3P-DX / 200 ... 230 Vdc

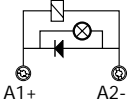

RC suppressor and LED

M3P-RC / 20 ... 50 Vac
M3P-RC / 110 ... 120 Vac
M3P-RC / 220 ... 240 Vac

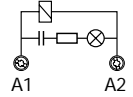

M3S Plug in modules for S3-MS

In series with the coil

Free wheeling and polarity

M3S-FL / 12 ... 60 Vdc
M3S-FH / 12 ... 250 Vdc

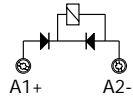

Free wheeling, polarity and LED

M3S-FX / 24 Vdc
M3S-FX / 48 Vdc
M3S-FX / 110 ... 125 Vdc
M3S-FX / 200 ... 230 Vdc

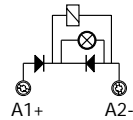

Rectifier bridge and LED

M3S-B / 12 ... 48 Vac/dc
M3S-BX / 12 Vac/dc
M3S-BX / 24 Vac/dc
M3S-BX / 48 Vac/dc

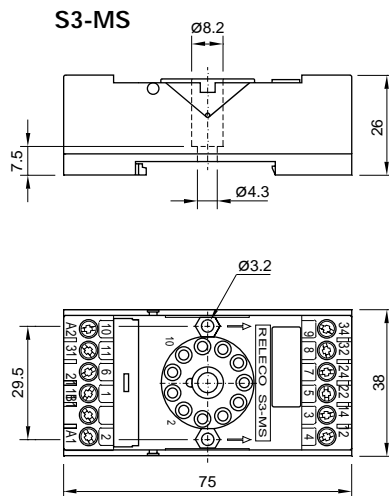
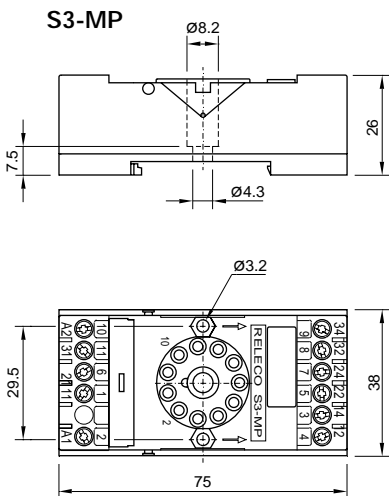
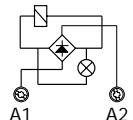

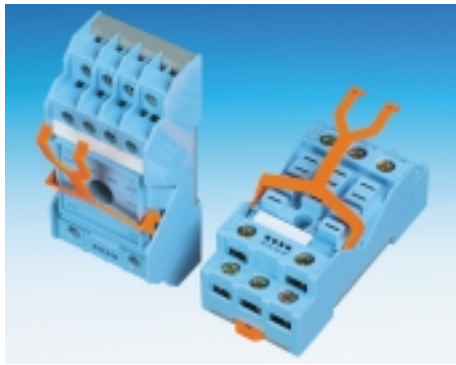

SOCKETS FOR C4 AND C5 RELAYS

- Built in retaining clip
- Removable label marking facility
- Two level terminals
- DIN rail, solder tag or PCB mount

S4-B

Two level screws
Logic wiring

Integrated hold-down clip and removable marking label. DIN rail or panel mountable. EN/DIN and sequential numbering. According to EN60947

Wiring diagram

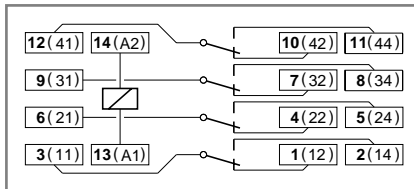

Specifications

Nominal load 10 A / 250 V
Dielectric strength (adjacent screws) 2,5 KV
Dielectric strength (screws / rail) 2,5 KV
Max. screw torque 1,2 Nm
Screw dimensions M3, Pozi
Wire in-lets capacity:
Solid wire 4 mm² or 2 x 2,25 mm²
Multi-core 22 - 14 AWG



S4-L S4-P S4-PO

14 pin, solder and printed circuit tags

S4-L Flange panel mountable.

S4-P Printed circuit tags.

S4-PO Printed circuit tags with flange.

Printed circuit lay-out

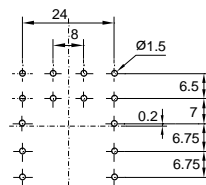

Specifications

Nominal load 10 A / 250 V
Dielectric strength (adjacent pin) 2,5 KV
Hard brass tin-plated terminals

S5-S

Two level screws
Logic wiring

Integrated hold-down clip and removable marking label. DIN rail or panel mountable. EN/DIN and sequential numbering. According to EN60947

Wiring diagram

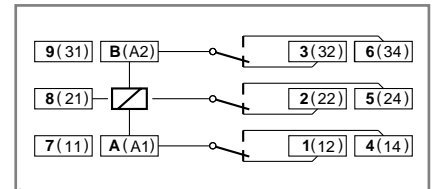

Specifications

Nominal load 16 A / 400 V
Dielectric strength (adjacent screws) 2,5 KV
Dielectric strength (screws / rail) 2,5 KV
Max. screw torque 1,2 Nm
Screw dimensions M3, Pozi
Wire in-lets capacity:
Solid wire 4 mm² or 2 x 2,25 mm²
Multi-core 22 - 14 AWG



S4-B

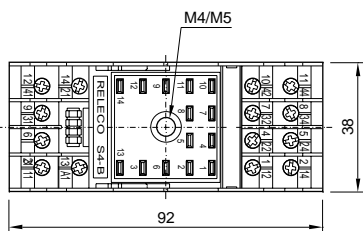
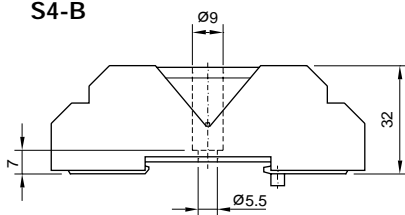

S4-PO S4-L

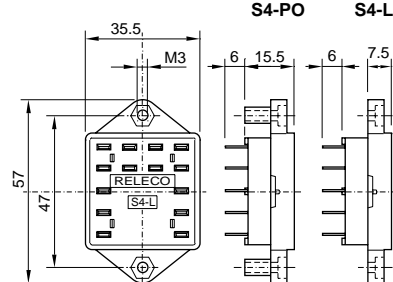

S4-P

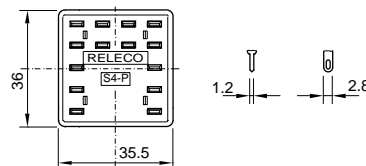

S5-S

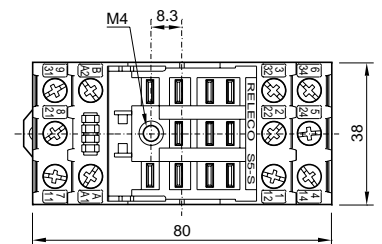
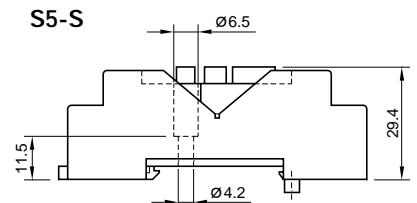



SOCKETS FOR C7 RELAYS

- Built in retaining clip
- Removable label marking facility
- One level terminals & in line screws (on S7M)
- S7M is only 22.5mm wide
- S7-IO input-output socket
- Bridge bar available for S7-IO

S7-M One level, screws on line
22,5 mm wide

Socket offers an optimum packing density and is provided with sturdy screws terminals. DIN rail or panel mountable. Integrated clip. Removable marking label EN/DIN and sequential numbering.

Wiring diagram

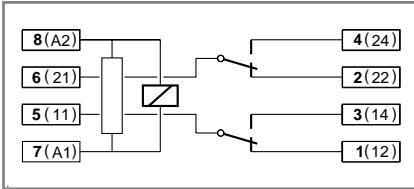

Specifications

Nominal load 10 A / 250 V
 Dielectric strength (adjacent screws) 2,5 KV
 Dielectric strength (screws / rail) 2,5 KV
 Max. screw torque 1,2 Nm
 Screw dimensions M3, Pozi
 Wire in-lets capacity:
 Solid wire 4 mm² or 2 x 2,25 mm²
 Multi-core 22 - 14 AWG

S7-L S7-P S7-PO
Solder and printed circuit tags

S7-L Flange panel mountable.
S7-P Printed circuit tags.
S7-PO Printed circuit tags with flange.

Printed circuit lay-out

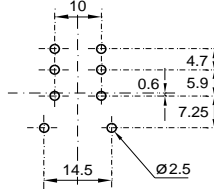

Specifications

Nominal load 10 A / 250 V
 Dielectric strength (adjacent screws) 2,5 KV
 Hard brass tin-plated terminals

S7-IO Input-Output socket
for 2 pole C7 relay

Bridge bar for coil (A2), Integrated clip, DIN rail or panel mounting

Specifications

Nominal load 10 A / 250 V
 Dielectric strength (input-output) 2,5 KV
 Dielectric strength (screws / rail) 2,5 KV
 M3, Pozi screw max. torque 1,2 Nm
 Wire inlet capacity multi-core 22 - 14 AWG
 Wire inlet solid wire 4 mm² or 2 x 2,25 mm²
 Weight avg. 48 grs.

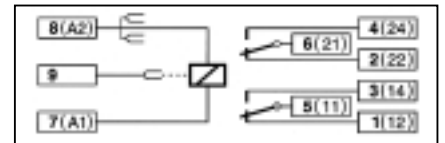

Lloyd's

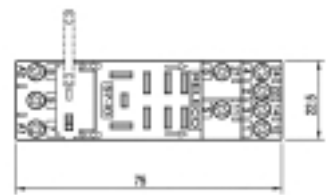

S7-M

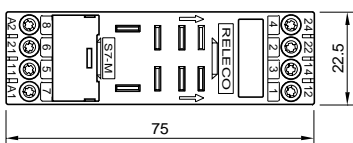
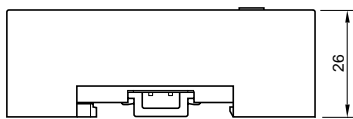

S7-PO

S7-L

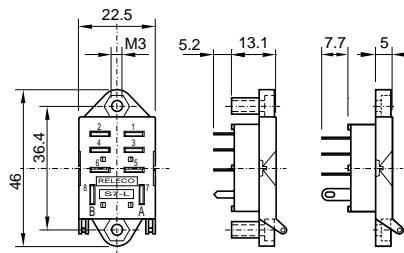

S7-P

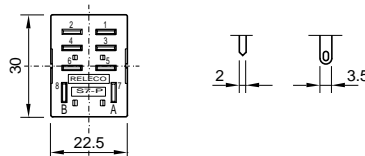

S7BB Bridge Bar

Bridge bar for use with S7-IO sockets. Pack quantity 5 pieces of strips of 4.

Bridge bar (pack of five) S7BB



S7-16 16A Socket

16A rated socket @ 250V specifically for use with C7-A10 16A single pole relays. All other characteristics as per S7-M

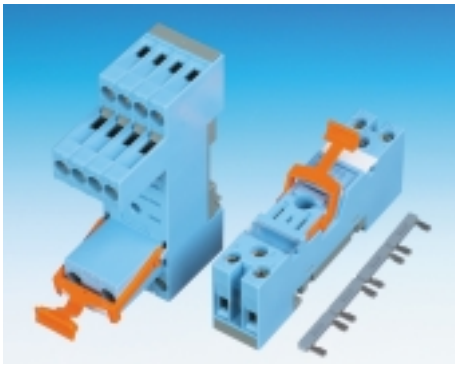

SOCKETS FOR C9 & C10 RELAYS

- Built in retaining clip
- Removable label marking facility
- DIN rail, solder tag or PCB mount
- S9M is only 22.5mm wide
- Bridge bar available for S-10
- S-10 is only 16.5mm wide

S9-M Two level, screws in line
22,5 mm wide

Socket offers an optimum packing density and is provided with sturdy screws terminals. DIN rail or panel mountable. Integrated clip. Removable marking label. EN/DIN and sequential numbering.

Wiring diagram

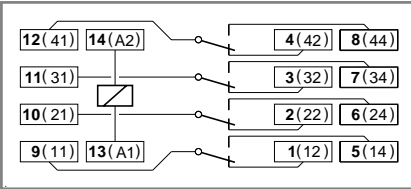

Specifications

Nominal load 6 A / 250V
 Dielectric strength (adjacent screws) 2,5 KV
 Dielectric strength (screws / rail) 2,5 KV
 Max. screw torque 1,2 Nm
 Screw dimensions M3, Pozi
 Wire in-lets capacity:
 Solid wire 4 mm² or 2 x 2,25 mm²
 Multi-core 22 - 14 AWG



S9-L S9-P S9-PO
Solder and printed circuit tags

S9-L Flange panel mountable.
S9-P Printed circuit tags.
S9-PO Printed circuit tags with flange.

Printed circuit lay-out

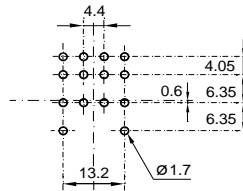

Specifications

Nominal load 6 A / 250 V
 Dielectric strength (adjacent screws) 2,5KV
 Hard brass tin-plated terminals



S-10 Input-Output socket
for C10 relay

Bridge bar for coil and movable contact, Integrated clip, DIN rail or panel mounting

Specifications

Nominal load 10 A / 250 V
 Dielectric strength (input-output) 8 mm - 5 KV
 Dielectric strength (screws / rail) 5 KV
 M3, Pozi screw max. torque 1,2 Nm
 Wire inlet capacity multi-core 22 - 14 AWG
 Wire inlet solid wire 4 mm² or 2 x 2,25 mm²
 Weight avg. 28 grs.

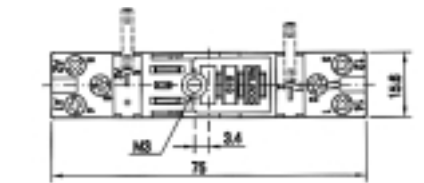
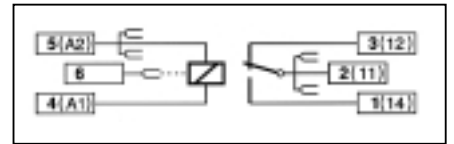

S10BB Bridge Bar

Bridge bar for use with S-10 sockets. Pack quantity 5 pieces of strips of 4.

Bridge bar (pack of five) S10BB



S9-M

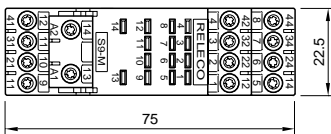
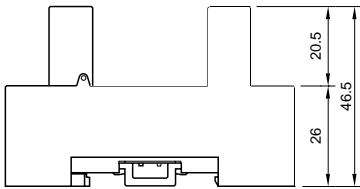

S9-PO

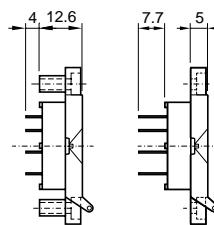
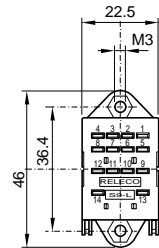

S9-P

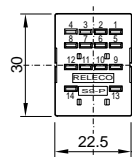

X-ON Electronics

Largest Supplier of Electrical and Electronic Components

Click to view similar products for [releco](#) manufacturer:

Other Similar products are found below :

[S-12](#) [S2B + S2BC](#) [C10A10X230A](#) [C3-A30X24D](#) [C12A21BX24AD](#) [C2-A20X230A](#) [C7-A20X24D](#) [C4-A40X230A](#) [S4-B+S3-C](#)
[C10A10X24D](#) [S9-M](#) [C4-A40X24D](#) [C9-A41X115A](#)