

NICHIA CORPORATION

SPECIFICATIONS FOR GREEN LED

NEPG510S

- RoHS Compliant



SPECIFICATIONS

(1) Absolute Maximum Ratings

Item	Symbol	Absolute Maximum Rating	Unit
Forward Current	I_F	25	mA
Pulse Forward Current	I_{FP}	80	mA
Reverse Voltage	V_R	5	V
Power Dissipation	P_D	96.2	mW
Operating Temperature	T_{opr}	-30~85	°C
Storage Temperature	T_{stg}	-40~100	°C
Junction Temperature	T_J	100	°C

* Absolute Maximum Ratings at $T_A=25^\circ\text{C}$.

* I_{FP} conditions with pulse width $\leq 10\text{ms}$ and duty cycle $\leq 10\%$.

(2) Initial Electrical/Optical Characteristics

Item	Symbol	Condition	Typ	Unit
Forward Voltage	V_F	$I_F=20\text{mA}$	3.3	V
Luminous Intensity	I_v	$I_F=20\text{mA}$	6.8	cd
Chromaticity Coordinate	x	$I_F=20\text{mA}$	0.17	-
	y	$I_F=20\text{mA}$	0.70	-

* Characteristics at $T_A=25^\circ\text{C}$.

* Luminous Intensity value as per CIE 127:2007 standard.

* Chromaticity Coordinates as per CIE 1931 Chromaticity Chart.

RANKS

Item	Rank	Min	Max	Unit
Forward Voltage	-	2.85	3.85	V
Reverse Current	-	-	50	μA
Luminous Intensity	U	9.64	13.76	cd
	T	6.88	9.64	
	S	4.82	6.88	

Color Ranks

	Rank G			
x	0.14	0.14	0.22	0.22
y	0.64	0.74	0.74	0.64

	Rank H			
x	0.21	0.21	0.28	0.28
y	0.65	0.73	0.73	0.65

- * Ranking at $T_A=25^{\circ}\text{C}$.
- * Reverse Current at $V_R=5\text{V}$.
- * Tolerance of measurements of the Forward Voltage is $\pm 0.05\text{V}$.
- * Tolerance of measurements of the Luminous Intensity is $\pm 10\%$.
- * Tolerance of measurements of the Chromaticity Coordinate is ± 0.01 .
- * A shipment shall consist of LEDs in a combination of the above ranks.
The percentage of each rank in the shipment shall be determined by Nichia.

CHROMATICITY DIAGRAM

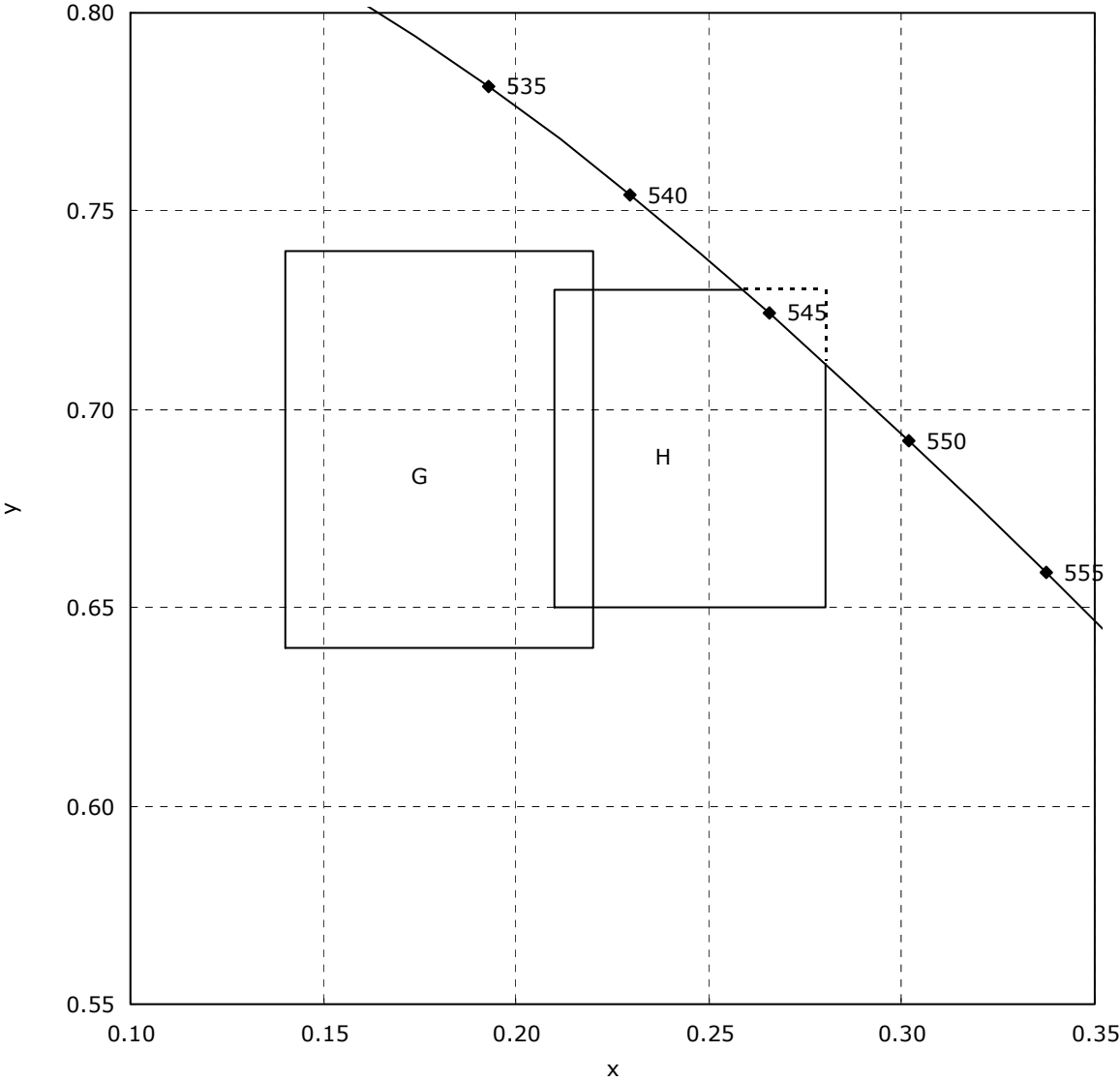

OUTLINE DIMENSIONS

* 本製品はRoHS指令に適合しております。
This product complies with RoHS Directive.

NEPG510S
管理番号 No. STS-DA7-1714

(単位 Unit: mm, 公差 Tolerance: ±0.2)

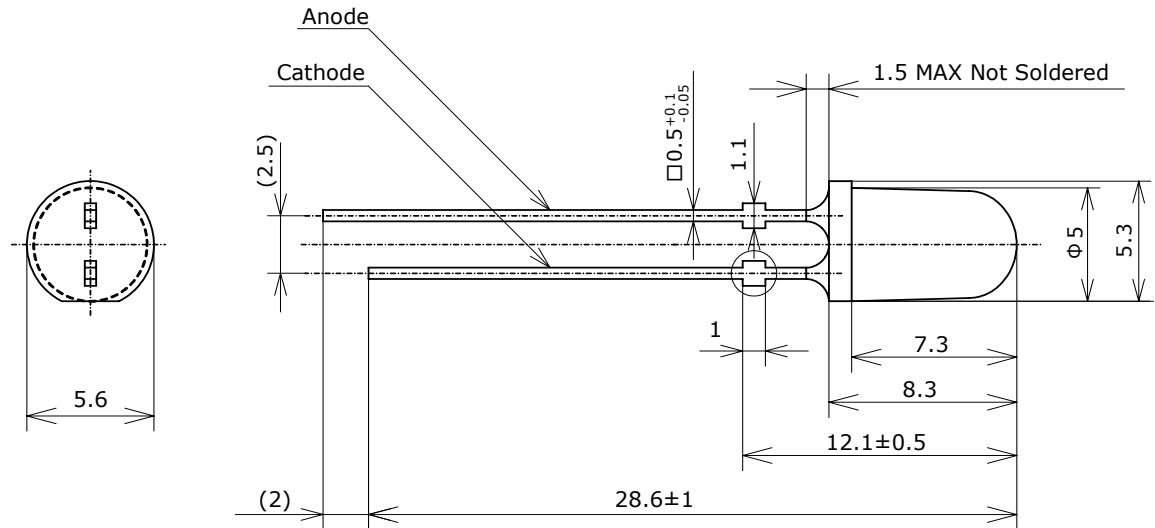

ストップパー部詳細図
Lead Standoff

項目 Item	内容 Description
樹脂材質 Resin Materials	エポキシ樹脂 Epoxy Resin
リードフレーム材質 Lead Frame Materials	鉄+銀メッキ+鉛フリーはんだメッキ Ag-plated and Lead-free Solder-plated Iron
質量 Weight	0.27g(TYP)

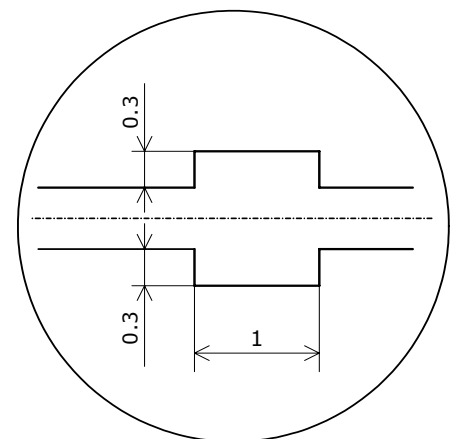

* タイバーを切り取った部分は鉄が露出しております。
またLEDには鋭利な部分があります。特にリード部分は、人体を傷つける
ことがありますので、取り扱いに際しては十分注意して下さい。
The tie bar cut-end surface exhibits exposed iron base metal.
Care must be taken to handle the LEDs, as it may contain sharp parts
such as lead, and can cause injury.

* はんだメッキ部に素地の著しい露出はないこととします。
No noticeable exposure of base metal of the lead with a solder-dipped finish.

SOLDERING

• Recommended Hand Soldering Condition

Temperature	350°C Max
Soldering Time	3sec Max
Position	No closer than 3mm from the base of the lens.

• Recommended Dip Soldering Condition

Pre-Heat	120°C Max
Pre-Heat Time	60sec Max
Solder Bath Temperature	260°C Max
Dipping Time	10sec Max
Dipping Position	No closer than 3mm from the base of the lens.

- * Solder the LED no closer than 3mm from the base of the lens.
Soldering beyond the base of the tie bar is recommended.
- * Dip soldering/hand soldering must not be performed more than once.
- * Care should be taken to avoid cooling at a rapid rate and ensure the peak temperature ramps down slowly.
- * When soldering, do not apply stress to the lead frame while the LED is hot.
- * After soldering, the LED position must not be corrected.
- * After soldering, NO mechanical shock or vibration should be applied to LED lens until the LEDs cool down to room temperature.
- * In order to avoid damage on the lens during cutting and clinching the leads, it is not recommended to solder the LEDs directly on customer PCB without any gap between the lens and the board. If it is unavoidable, customer is advised to check whether such soldering will not cause wire breakage or lens damage. Direct soldering to double-sided PCBs must be avoided due to an increased effect of heat on the lens.
- * When it is necessary to clamp the LEDs to prevent soldering failure, it is important to minimize the mechanical stress on the LEDs.
- * Cut the LED lead frames at room temperature. Cutting the lead frames at high temperature may cause failure of the LEDs.

PACKAGING - BULK

Nxxxxxxx
管理番号 No. STS-DA7-0001B

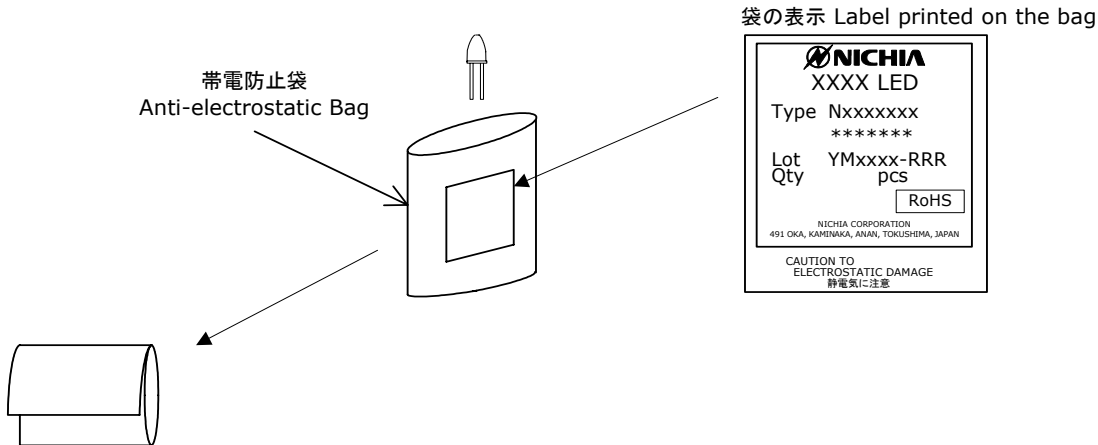

帯電防止袋を並べて入れ、ダンボールで仕切ります。
Anti-electrostatic bags are packed in cardboard boxes with corrugated partitions.

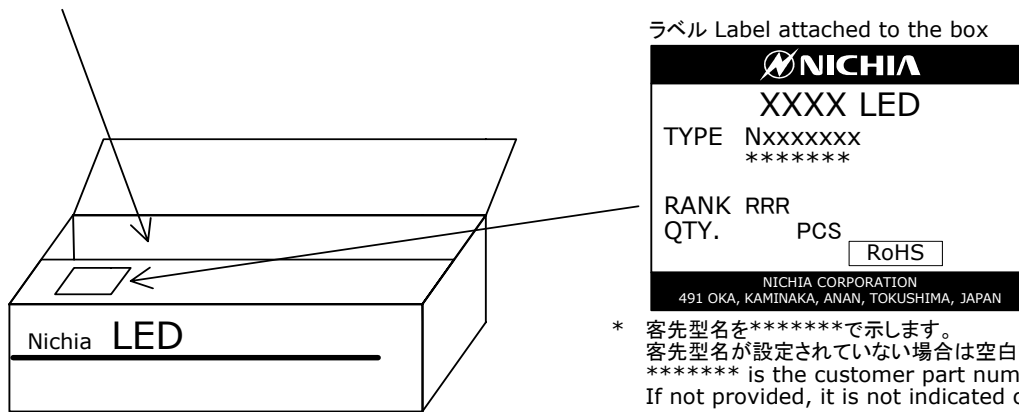

- * 客先型名を*****で示します。
客先型名が設定されていない場合は空白です。
***** is the customer part number.
If not provided, it is not indicated on the label.
- * ロット表記方法についてはロット番号の項を参照して下さい。
For details, see "LOT NUMBERING SCHEME" in this document.

- * 本製品は帯電防止袋に入れたのち、輸送の衝撃から保護するためダンボールで梱包します。
Products are packed in an anti-electrostatic bag.
They are shipped in cardboard boxes to protect them from external forces during transportation.
- * 取り扱いに際して、落下させたり、強い衝撃を与えたりしますと、製品を損傷させる原因になりますので注意して下さい。
Do not drop or shock the box. It may damage the products.
- * ダンボールには防水加工がされておりませんので、梱包箱が水に濡れないよう注意して下さい。
Do not expose to water, the box is not water-resistant.
- * 輸送、運搬に際して弊社よりの梱包状態あるいは同等の梱包を行って下さい。
Using an original packaging material or equivalent in transit is recommended.

LOT NUMBERING SCHEME

Lot Number is presented by using the following alphanumeric code.

YMxxxx - RRR

Y - Year

Year	Y
2009	9
2010	A
2011	B
2012	C
2013	D
2014	E

M - Month

Month	M	Month	M
1	1	7	7
2	2	8	8
3	3	9	9
4	4	10	A
5	5	11	B
6	6	12	C

xxxx-Nichia's Product Number

RRR-Ranking by Color Coordinates, Ranking by Luminous Intensity

DERATING CHARACTERISTICS

NEPG510(S)
管理番号 No. STS-DA7-1678

周囲温度-許容順電流特性
Ambient Temperature vs
Allowable Forward Current

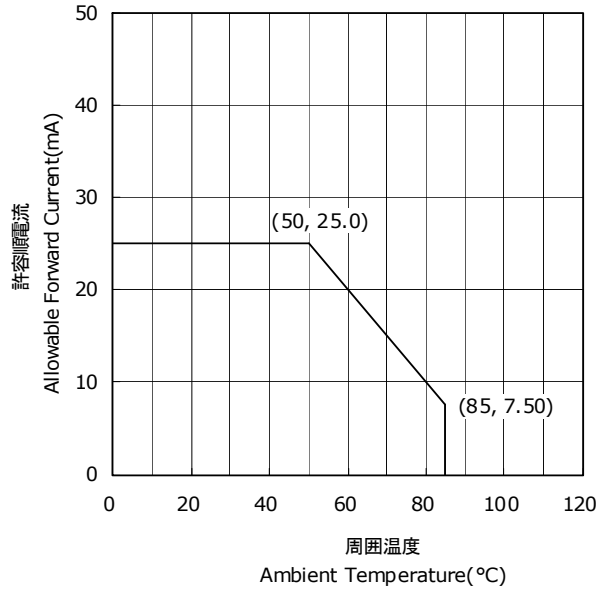

デューティー比-許容順電流特性
Duty Ratio vs
Allowable Forward Current

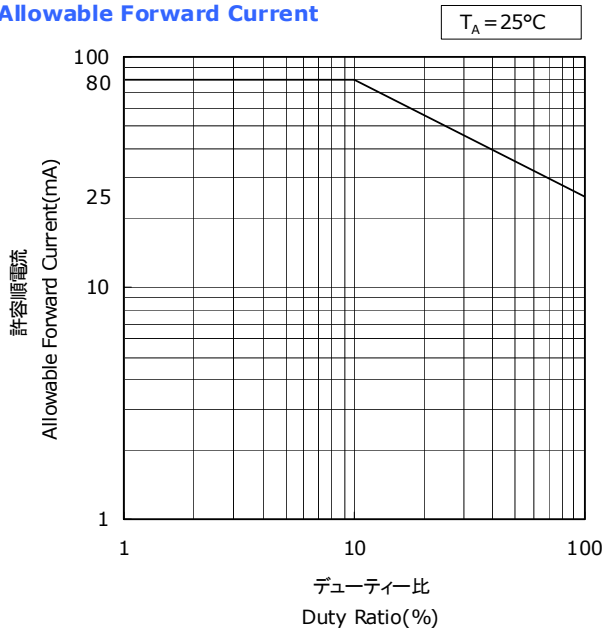

OPTICAL CHARACTERISTICS

* 本特性は参考です。
All characteristics shown are for reference only and are not guaranteed.

NEPG510(S)
管理番号 No. STS-DA7-1679

発光スペクトル Spectrum

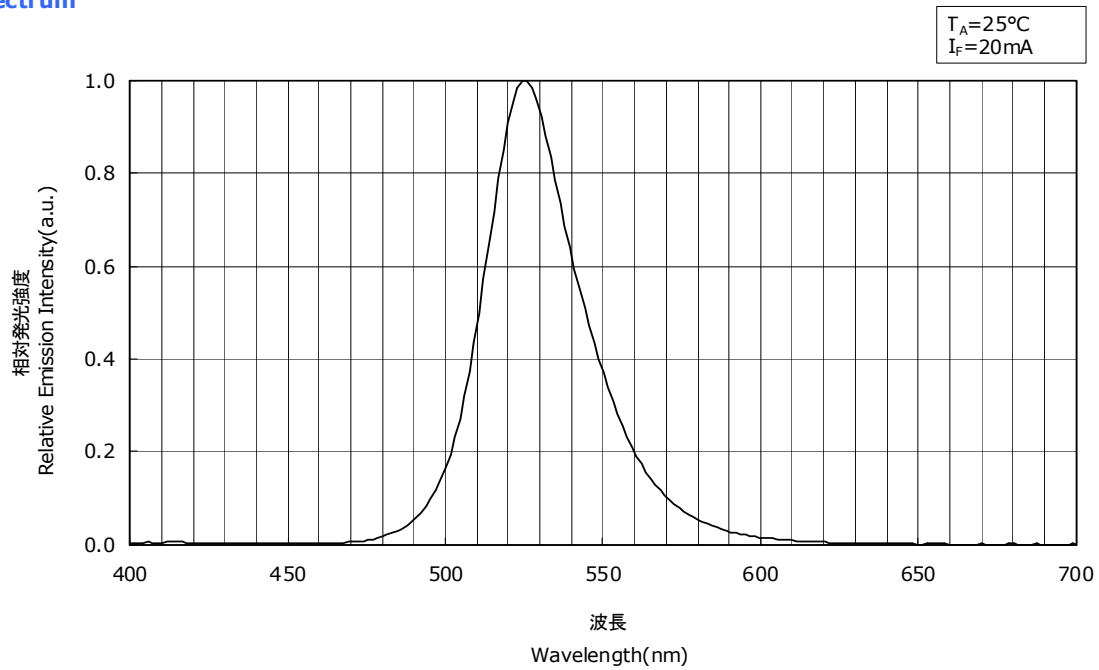

指向特性 Directivity

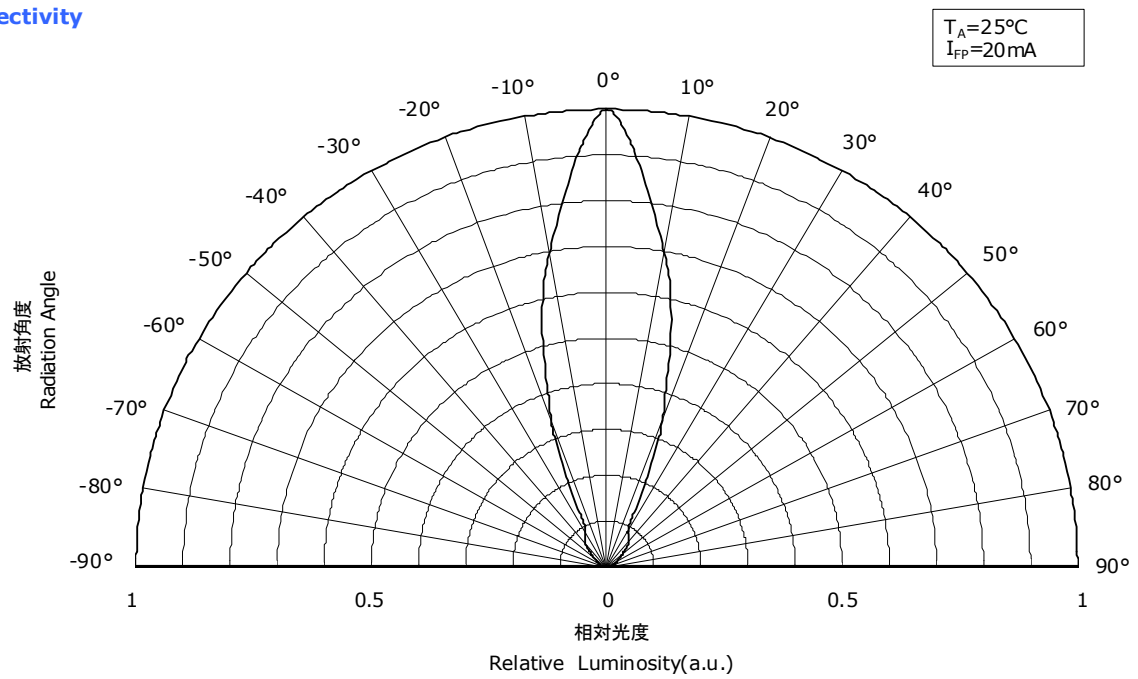

FORWARD CURRENT CHARACTERISTICS / TEMPERATURE CHARACTERISTICS

* 本特性は参考です。
All characteristics shown are for reference only and are not guaranteed.

NEPG510(S)
管理番号 No. STS-DA7-1680

順電圧-順電流特性
Forward Voltage vs Forward Current

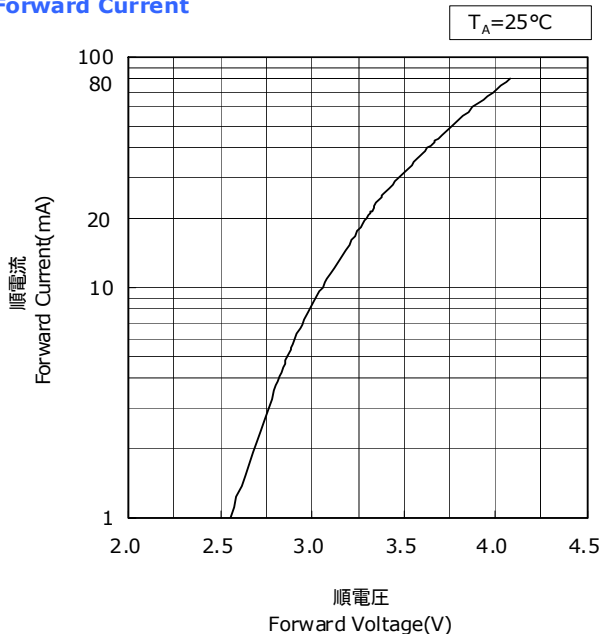

周囲温度-順電圧特性
Ambient Temperature vs Forward Voltage

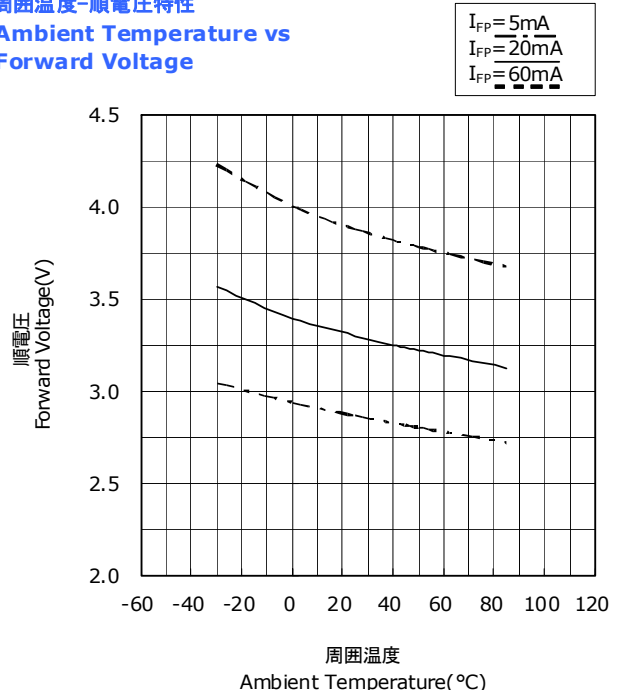

順電流-相対光度特性
Forward Current vs Relative Luminosity

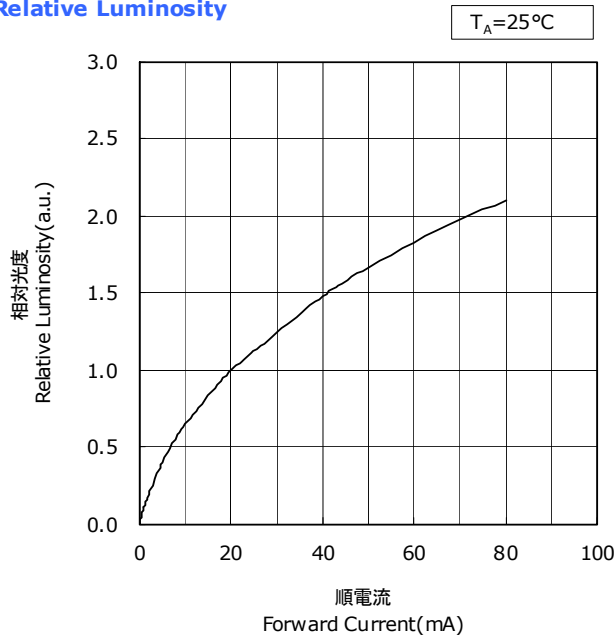

周囲温度-相対光度特性
Ambient Temperature vs Relative Luminosity

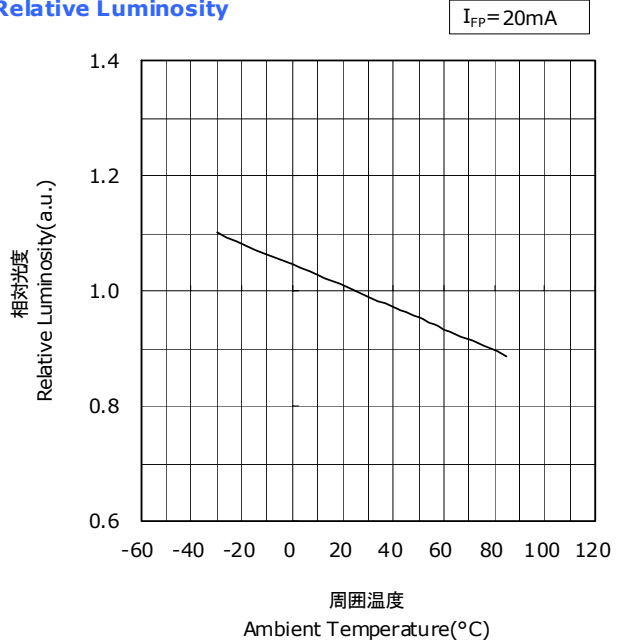

FORWARD CURRENT CHARACTERISTICS / TEMPERATURE CHARACTERISTICS

* 本特性は参考です。
All characteristics shown are for reference only and are not guaranteed.

NEPG510(S)
管理番号 No. STS-DA7-1681

順電流-色度(主波長)特性
Forward Current vs Chromaticity Coordinate(λ_d)

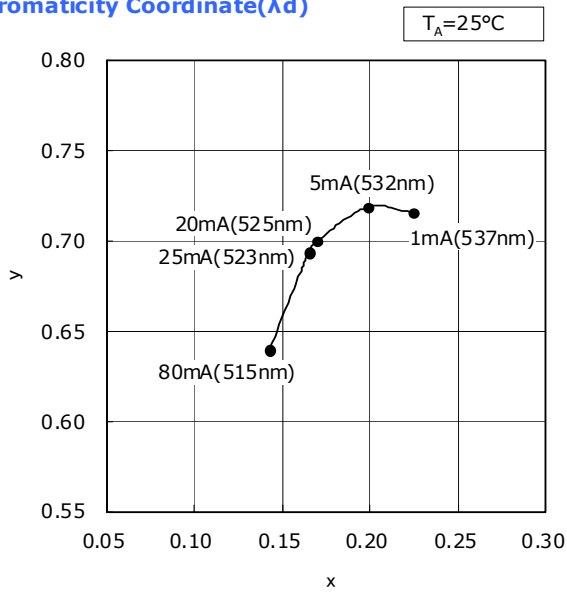

順電流-主波長特性
Forward Current vs Dominant Wavelength

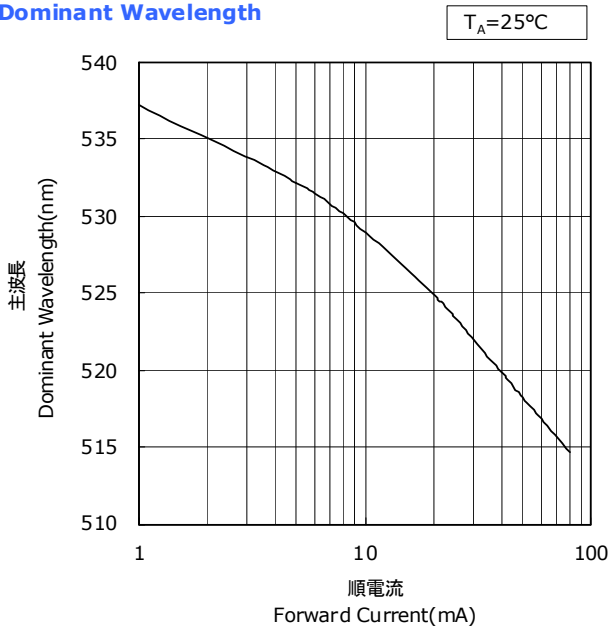

周囲温度-主波長特性
Ambient Temperature vs Dominant Wavelength

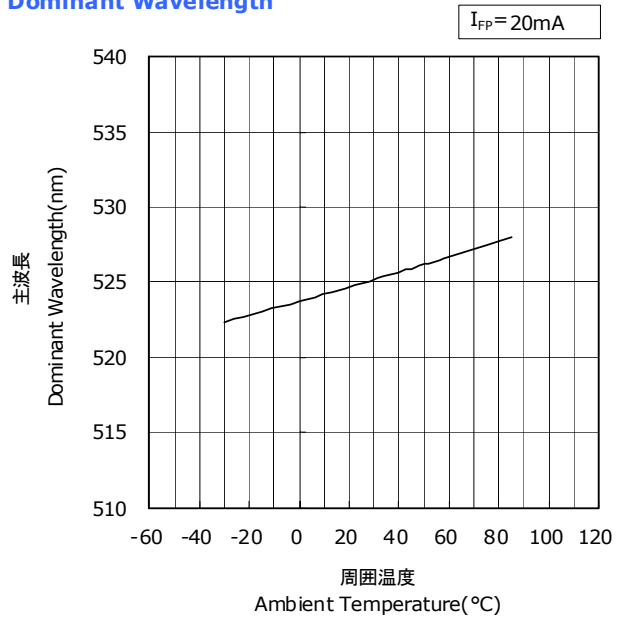

RELIABILITY

(1) Tests and Results

Test	Reference Standard	Test Conditions	Test Duration	Failure Criteria #	Units Failed/Tested
Resistance to Soldering Heat	JEITA ED-4701 300 302	$T_{\text{sold}}=260\pm 5^{\circ}\text{C}$, 10sec, 1dip, 3mm from the base of the lens		#1	0/50
Temperature Cycle	JEITA ED-4701 100 105	$-40^{\circ}\text{C}(30\text{min})\sim 25^{\circ}\text{C}(5\text{min})\sim$ $100^{\circ}\text{C}(30\text{min})\sim 25^{\circ}\text{C}(5\text{min})$	100cycles	#1	0/50
Moisture Resistance (Cyclic)	JEITA ED-4701 200 203	$25^{\circ}\text{C}\sim 65^{\circ}\text{C}\sim -10^{\circ}\text{C}$, 90%RH, 24hr per cycle	10cycles	#1	0/50
Terminal Bend Strength	JEITA ED-4701 400 401	5N, $0^{\circ}\sim 90^{\circ}\sim 0^{\circ}$ bend, 2bending cycles		#1	0/50
Terminal Pull Strength	JEITA ED-4701 400 401	10N, $10\pm 1\text{sec}$		#1	0/50
High Temperature Storage	JEITA ED-4701 200 201	$T_A=100^{\circ}\text{C}$	1000hours	#1	0/50
Temperature Humidity Storage	JEITA ED-4701 100 103	$T_A=60^{\circ}\text{C}$, RH=90%	1000hours	#1	0/50
Low Temperature Storage	JEITA ED-4701 200 202	$T_A=-40^{\circ}\text{C}$	1000hours	#1	0/50
Room Temperature Operating Life		$T_A=25^{\circ}\text{C}$, $I_F=25\text{mA}$	1000hours	#1	0/50
Temperature Humidity Operating Life		60°C , RH=90%, $I_F=15\text{mA}$	500hours	#1	0/50
Low Temperature Operating Life		$T_A=-30^{\circ}\text{C}$, $I_F=20\text{mA}$	1000hours	#1	0/50

NOTES:

Measurements are performed after allowing the LEDs to return to room temperature.

(2) Failure Criteria

Criteria #	Items	Conditions	Failure Criteria
#1	Forward Voltage(V_F)	$I_F=20\text{mA}$	$>U.S.L.\times 1.1$
	Luminous Intensity(I_V)	$I_F=20\text{mA}$	$<L.S.L.\times 0.7$
	Reverse Current(I_R)	$V_R=5\text{V}$	$>U.S.L.\times 2.0$

U.S.L. : Upper Specification Limit L.S.L. : Lower Specification Limit

CAUTIONS

(1) Lead Forming

- When forming leads, the leads should be bent at a point at least 3mm from the base of the epoxy bulb.
Do not use the base of the leadframe as a fulcrum during lead forming.
- Lead forming should be done before soldering.
- Do not apply any bending stress to the base of the lead.
The stress to the base may damage the LED's characteristics or it may break the LEDs.
- When mounting the product onto a printed circuit board, the via-holes on the board should be exactly aligned with the lead pitch of the product. If the LEDs are mounted with stress at the leads, it causes deterioration of the epoxy resin and this will degrade the LEDs.

(2) Storage

- Shelf life of the products in unopened bag is 3 months(max.) at <math><30^{\circ}\text{C}</math> and 70% RH from the delivery date.
If the shelf life exceeds 3 months or more, the LEDs need to be stored in a sealed container with silica gel desiccants to ensure their shelf life will not exceed 1 year.
- Customer is advised to store properly the products in controlled ambient and complete immediately all high temperature related process including soldering as exposure to corrosive environment might cause the plated metal parts of the product to tarnish, which might lead to difficulties in soldering.
- To avoid condensation, the products must not be stored in the areas where temperature and humidity fluctuate greatly.

(3) Directions for Use

- When designing a circuit, the current through each LED must not exceed the Absolute Maximum Rating.
Operating at a constant current per LED is recommended. In case of operating at a constant voltage, Circuit B is recommended.
If the LEDs are operated with constant voltage using Circuit A, the current through the LEDs may vary due to the variation in Forward Voltage characteristics of the LEDs.

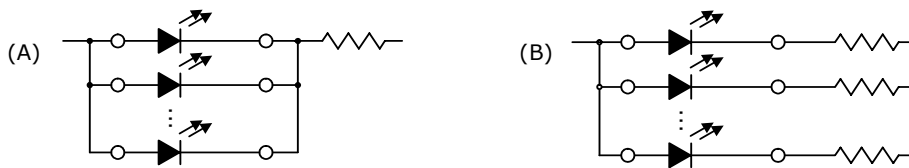

- LEDs should be operated in forward bias. Driving circuits must not subject LEDs to either forward or reverse voltage while off.
Continuous reverse voltage can cause migration and LED damage.
- For stabilizing the LED characteristics, it is recommended to operate at greater than 10% nominal current.
- Care must be taken to ensure that the reverse voltage will not exceed the Absolute Maximum Rating when using the LEDs with matrix drive.
- For outdoor use, necessary measures should be taken to prevent water, moisture and salt air damage.

(4) Handling Precautions

- Do not handle LEDs with bare hands, it may contaminate the LED surface and affect optical characteristics.
In the worst case, catastrophic failure from excess pressure through wire-bond breaks and package damage may result.
- Dropping the product may cause damage.
- Do not stack assembled PCBs together. Failure to comply can cause the resin portion of the product to be cut, chipped, delaminated and/or deformed. It may cause wire to break, leading to catastrophic failures.

(5) Design Consideration

- PCB warpage after mounting the products onto a PCB can cause the package to break.
The LED should be placed in a way to minimize the stress on the LEDs due to PCB bow and twist.
- The position and orientation of the LEDs affect how much mechanical stress is exerted on the LEDs placed near the score lines.
The LED should be placed in a way to minimize the stress on the LEDs due to board flexing.
- Board separation must be performed using special jigs, not using hands.

(6) Electrostatic Discharge (ESD)

- The products are sensitive to static electricity or surge voltage. ESD can damage a die and its reliability.
When handling the products, the following measures against electrostatic discharge are strongly recommended:
 - Eliminating the charge
 - Grounded wriststrap, ESD footwear, clothes, and floors
 - Grounded workstation equipment and tools
 - ESD table/shelf mat made of conductive materials
- Proper grounding is required for all devices, equipment, and machinery used in product assembly.
Surge protection should be considered when designing of commercial products.
- If tools or equipment contain insulating materials such as glass or plastic,
the following measures against electrostatic discharge are strongly recommended:
 - Dissipating static charge with conductive materials
 - Preventing charge generation with moisture
 - Neutralizing the charge with ionizers
- The customer is advised to check if the LEDs are damaged by ESD
when performing the characteristics inspection of the LEDs in the application.
Damage can be detected with a forward voltage measurement or a light-up test at low current ($\leq 1\text{mA}$).
- ESD damaged LEDs may have an increased leakage current, current flow at a low voltage or no longer illuminate at a low current.
Failure Criteria: $V_F < 2.0\text{V}$ at $I_F = 0.5\text{mA}$

(7) Thermal Management

- Proper thermal management is an important when designing products with LEDs. LED die temperature is affected by PCB thermal resistance and LED spacing on the board. Please design products in a way that the LED die temperature does not exceed the maximum Junction Temperature (T_J).
- Drive current should be determined for the surrounding ambient temperature (T_A) to dissipate the heat from the product.

(8) Cleaning

- If required, isopropyl alcohol (IPA) should be used. Other solvents may cause premature failure to the LEDs due to the damage to the resin portion. The effects of such solvents should be verified prior to use.
In addition, the use of CFCs such as Freon is heavily regulated.
- Ultrasonic cleaning is not recommended since it may have adverse effects on the LEDs depending on the ultrasonic power and how LED is assembled.
If ultrasonic cleaning must be used, the customer is advised to make sure the LEDs will not be damaged prior to cleaning.

(9) Eye Safety

- In 2006, the International Electrical Commission (IEC) published IEC 62471:2006 Photobiological safety of lamps and lamp systems, which added LEDs in its scope.
On the other hand, the IEC 60825-1:2007 laser safety standard removed LEDs from its scope.
However, please be advised that some countries and regions have adopted standards based on the IEC laser safety standard IEC 60825-1:2011/2001, which still includes LEDs in its scope.
Most of Nichia's LEDs can be classified as belonging into either the Exempt Group or Risk Group 1.
High-power LEDs, that emit light containing blue wavelengths, may be classified as Risk Group 2.
Please proceed with caution when viewing directly any LEDs driven at high current, or viewing LEDs with optical instruments which may greatly increase the damages to your eyes.
- Viewing a flashing light may cause eye discomfort. When incorporating the LED into your product, please be careful to avoid adverse effects on the human body caused by light stimulation.

(10) Others

- The LEDs described in this brochure are intended to be used for ordinary electronic equipment (such as office equipment, communications equipment, measurement instruments and household appliances).
Consult Nichia's sales staff in advance for information on the applications in which exceptional quality and reliability are required, particularly when the failure or malfunction of the LEDs may directly jeopardize life or health (such as for airplanes, aerospace, submersible repeaters, nuclear reactor control system, automobiles, traffic control equipment, life support systems and safety devices).
- The customer shall not reverse engineer by disassembling or analysis of the LEDs without having prior written consent from Nichia. When defective LEDs are found, the customer shall inform Nichia directly before disassembling or analysis.
- Both the customers and Nichia will agree on official specifications of supplied products before a customer's volume production.
- Specifications and appearance subject to change for improvement without notice.

X-ON Electronics

Largest Supplier of Electrical and Electronic Components

Click to view similar products for [marl](#) manufacturer:

Other Similar products are found below :

[512-532-22](#) [512-532-23](#) [514-114-76](#) [661-508-64-40](#) [651-102-76](#) [671-066-75](#) [352-509-04](#) [352-505-04](#) [205-997-22-38](#) [524-521-21](#) [677-521-23-Y](#) [512-521-21](#) [671-064-75](#) [677-930-21-19](#) [209-521-23-38](#) [520-325-23](#) [651-114-21](#) [690-997-66](#) [508-930-22](#) [671-062-75](#) [525-095-21-50](#) [512-501-75](#) [531-532-63](#) [524-501-21](#) [514-111-75](#) [508-521-21](#) [520-324-23](#) [215-532-23-38](#) [671-063-23](#) [671-066-23](#) [215-532-76-38](#) [604-998-23](#) [662-303-04](#) [690-521-66](#) [671-064-23](#) [215-521-23-38](#) [677-501-22-R](#) [677-532-21-19](#) [698-532-63](#) [570-320-04-40](#) [209-930-23-38](#) [514-105-22](#) [512-501-22](#) [570-314-04-40](#) [528-532-22](#) [528-521-22](#) [512-997-22](#) [671-291-22](#) [660-320-64-40](#) [528-501-21](#)