

# 74HC240; 74HCT240

Octal buffer/line driver; 3-state; inverting

Rev. 03 — 2 August 2007

Product data sheet

## 1. General description

The 74HC240; 74HCT240 is a high-speed Si-gate CMOS device and is pin compatible with Low-Power Schottky TTL (LSTTL).

The 74HC240; 74HCT240 is a dual octal inverting buffer/line driver with 3-state outputs. The 3-state outputs are controlled by the output enable inputs  $\overline{1OE}$  and  $\overline{2OE}$ . A HIGH on  $\overline{nOE}$  causes the outputs to assume a high impedance OFF-state.

The 74HC240; 74HCT240 is similar to the 74HC244; 74HCT244 but has inverting outputs.

## 2. Features

- Inverting 3-state outputs
- Multiple package options
- Complies with JEDEC standard no. 7 A
- ESD protection:
  - ◆ HBM JESD22-A114-D exceeds 2000 V
  - ◆ MM JESD22-A115-A exceeds 200 V
- Specified from  $-40\text{ }^{\circ}\text{C}$  to  $+85\text{ }^{\circ}\text{C}$  and from  $-40\text{ }^{\circ}\text{C}$  to  $+125\text{ }^{\circ}\text{C}$

## 3. Ordering information

Table 1. Ordering information

Type number	Package			
	Temperature range	Name	Description	Version
<b>74HC240</b>				
74HC240N	$-40\text{ }^{\circ}\text{C}$ to $+125\text{ }^{\circ}\text{C}$	DIP20	plastic dual in-line package; 20 leads (300 mil)	SOT146-1
74HC240D	$-40\text{ }^{\circ}\text{C}$ to $+125\text{ }^{\circ}\text{C}$	SO20	plastic small outline package; 20 leads; body width 7.5 mm	SOT163-1
74HC240DB	$-40\text{ }^{\circ}\text{C}$ to $+125\text{ }^{\circ}\text{C}$	SSOP20	plastic shrink small outline package; 20 leads; body width 5.3 mm	SOT339-1
74HC240PW	$-40\text{ }^{\circ}\text{C}$ to $+125\text{ }^{\circ}\text{C}$	TSSOP20	plastic thin shrink small outline package; 20 leads; body width 4.4 mm	SOT360-1
74HC240BQ	$-40\text{ }^{\circ}\text{C}$ to $+125\text{ }^{\circ}\text{C}$	DHVQFN20	plastic dual-in-line compatible thermal enhanced very thin quad flat package; no leads; 20 terminals; body $2.5 \times 4.5 \times 0.85$ mm	SOT764-1
<b>74HCT240</b>				
74HCT240N	$-40\text{ }^{\circ}\text{C}$ to $+125\text{ }^{\circ}\text{C}$	DIP20	plastic dual in-line package; 20 leads (300 mil)	SOT146-1

**Table 1. Ordering information ...continued**

Type number	Package			Version
	Temperature range	Name	Description	
74HCT240D	-40 °C to +125 °C	SO20	plastic small outline package; 20 leads; body width 7.5 mm	SOT163-1
74HCT240DB	-40 °C to +125 °C	SSOP20	plastic shrink small outline package; 20 leads; body width 5.3 mm	SOT339-1
74HCT240PW	-40 °C to +125 °C	TSSOP20	plastic thin shrink small outline package; 20 leads; body width 4.4 mm	SOT360-1
74HCT240BQ	-40 °C to +125 °C	DHVQFN20	plastic dual-in-line compatible thermal enhanced very thin quad flat package; no leads; 20 terminals; body 2.5 × 4.5 × 0.85 mm	SOT764-1

## 4. Functional diagram

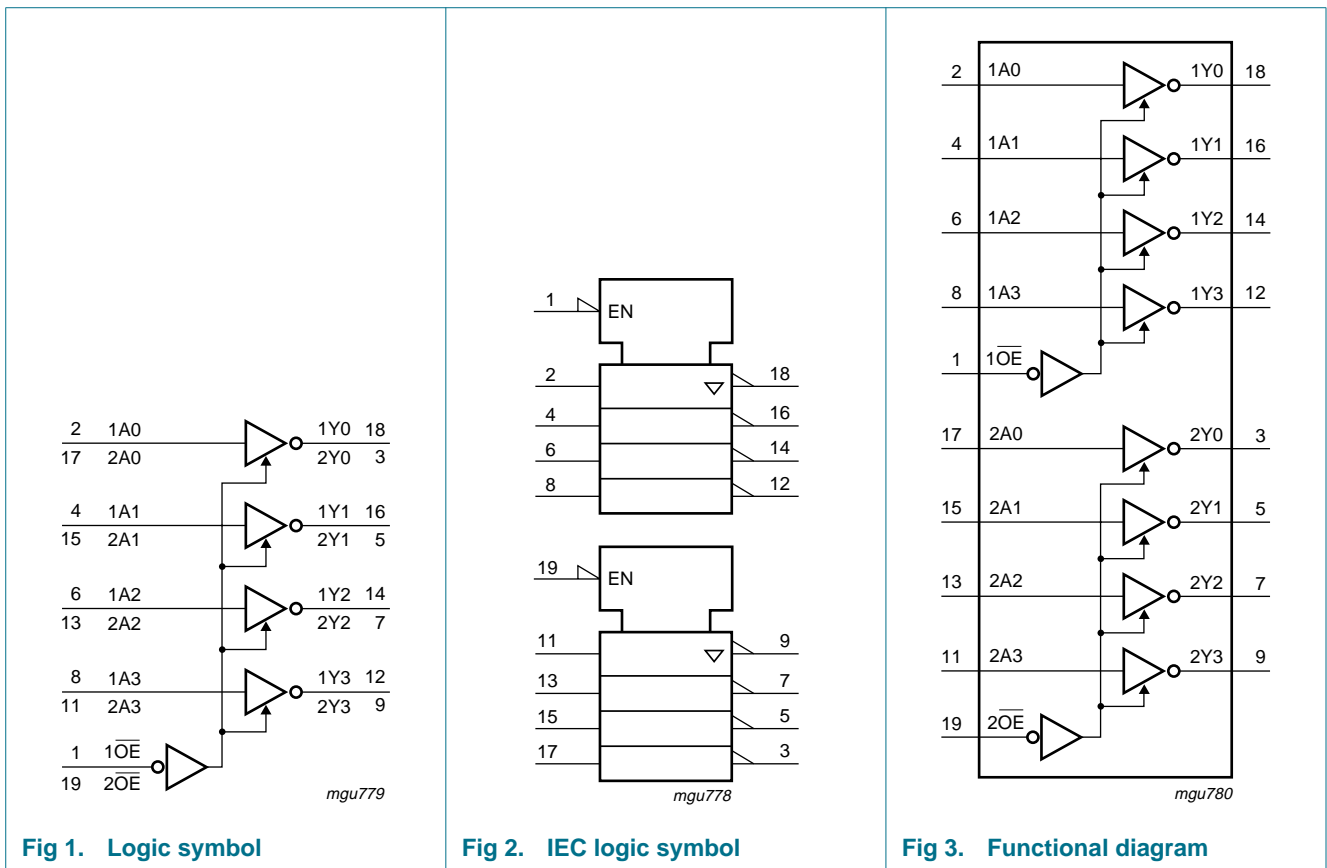

## 5. Pinning information

### 5.1 Pinning

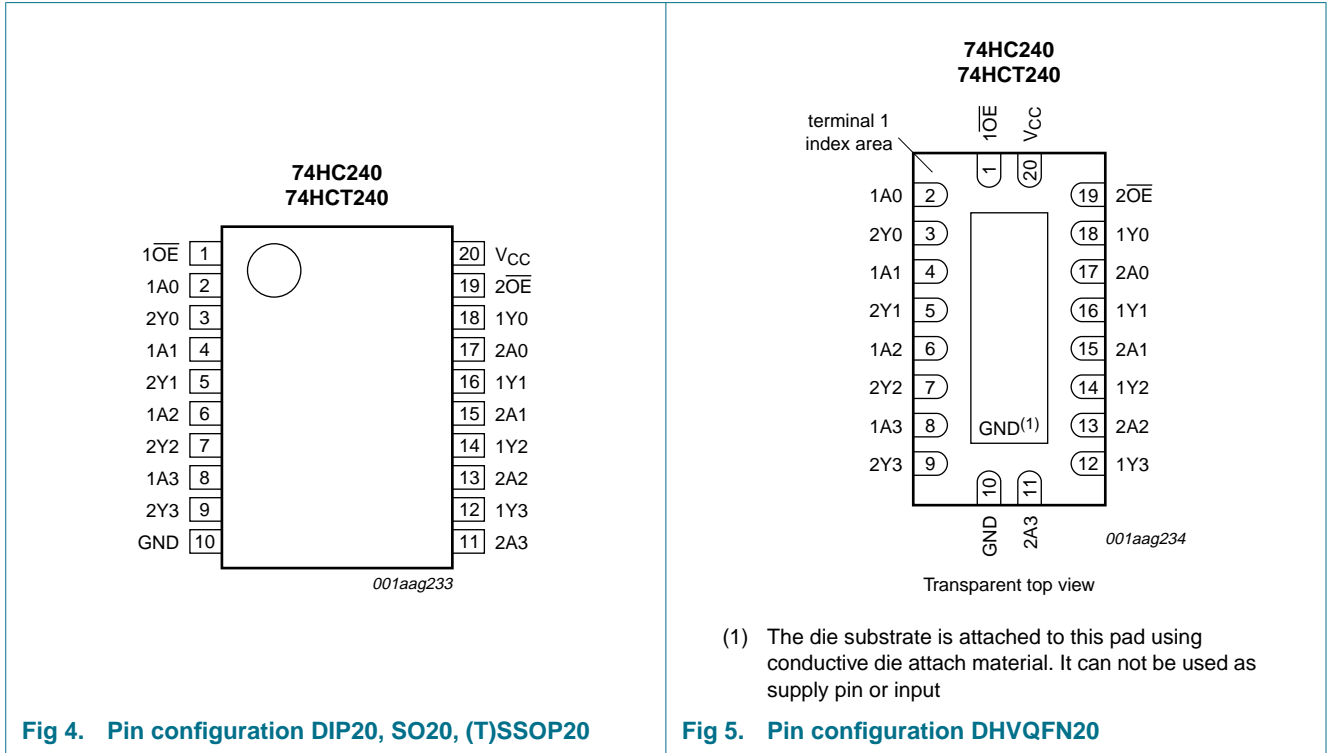

### 5.2 Pin description

Table 2. Pin description

Symbol	Pin	Description
10E	1	output enable input (active LOW)
1A0	2	data input
2Y0	3	bus output
1A1	4	data input
2Y1	5	bus output
1A2	6	data input
2Y2	7	bus output
1A3	8	data input
2Y3	9	bus output
GND	10	ground (0 V)
2A3	11	data input
1Y3	12	bus output
2A2	13	data input
1Y2	14	bus output
2A1	15	data input
1Y1	16	bus output

Table 2. Pin description ...continued

Symbol	Pin	Description
2A0	17	data input
1Y0	18	bus output
$\overline{2OE}$	19	output enable input (active LOW)
$V_{CC}$	20	supply voltage

## 6. Functional description

Table 3. Function table<sup>[1]</sup>

Input		Output	
nOE	nAn	nYn	
L	L	H	
L	H	L	
H	X	Z	

- [1] H = HIGH voltage level;  
 L = LOW voltage level;  
 X = don't care;  
 Z = high-impedance OFF-state.

## 7. Limiting values

Table 4. Limiting values

In accordance with the Absolute Maximum Rating System (IEC 60134). Voltages are referenced to GND (ground = 0 V).

Symbol	Parameter	Conditions	Min	Max	Unit
$V_{CC}$	supply voltage		-0.5	+7	V
$I_{IK}$	input clamping current	$V_I < -0.5\text{ V}$ or $V_I > V_{CC} + 0.5\text{ V}$	-	$\pm 20$	mA
$I_{OK}$	output clamping current	$V_O < -0.5\text{ V}$ or $V_O > V_{CC} + 0.5\text{ V}$	-	$\pm 20$	mA
$I_O$	output current	$-0.5\text{ V} < V_O < V_{CC} + 0.5\text{ V}$	-	$\pm 35$	mA
$I_{CC}$	supply current		-	70	mA
$I_{GND}$	ground current		-70	-	mA
$T_{stg}$	storage temperature		-65	+150	°C
$P_{tot}$	total power dissipation		<sup>[1]</sup>		
	DIP20 package		-	750	mW
	SO20, SSOP20, TSSOP20 and DHVQFN20 packages		-	500	mW

- [1] For DIP20 packages: above 70 °C,  $P_{tot}$  derates linearly with 12 mW/K.  
 For SO20 packages: above 70 °C,  $P_{tot}$  derates linearly with 8 mW/K.  
 For SSOP20 and TSSOP20 packages: above 60 °C,  $P_{tot}$  derates linearly with 5.5 mW/K.  
 For DHVQFN20 packages: above 60 °C,  $P_{tot}$  derates linearly with 4.5 mW/K.

## 8. Recommended operating conditions

**Table 5. Recommended operating conditions**

Symbol	Parameter	Conditions	Min	Typ	Max	Unit
<b>74HC240</b>						
$V_{CC}$	supply voltage		2.0	5.0	6.0	V
$V_I$	input voltage		0	-	$V_{CC}$	V
$V_O$	output voltage		0	-	$V_{CC}$	V
$\Delta t/\Delta V$	input transition rise and fall rate	$V_{CC} = 2.0\text{ V}$	-	-	625	ns/V
		$V_{CC} = 4.5\text{ V}$	-	1.67	139	ns/V
		$V_{CC} = 6.0\text{ V}$	-	-	83	ns/V
$T_{amb}$	ambient temperature		-40	-	+125	°C
<b>74HCT240</b>						
$V_{CC}$	supply voltage		4.5	5.0	5.5	V
$V_I$	input voltage		0	-	$V_{CC}$	V
$V_O$	output voltage		0	-	$V_{CC}$	V
$\Delta t/\Delta V$	input transition rise and fall rate	$V_{CC} = 4.5\text{ V}$	-	1.67	139	ns/V
$T_{amb}$	ambient temperature		-40	-	+125	°C

## 9. Static characteristics

**Table 6. Static characteristics**

At recommended operating conditions; voltages are referenced to GND (ground = 0 V).

Symbol	Parameter	Conditions	25 °C			-40 °C to +85 °C		-40 °C to +125 °C		Unit
			Min	Typ	Max	Min	Max	Min	Max	
<b>74HC240</b>										
$V_{IH}$	HIGH-level input voltage	$V_{CC} = 2.0\text{ V}$	1.5	1.2	-	1.5	-	1.5	-	V
		$V_{CC} = 4.5\text{ V}$	3.15	2.4	-	3.15	-	3.15	-	V
		$V_{CC} = 6.0\text{ V}$	4.2	3.2	-	4.2	-	4.2	-	V
$V_{IL}$	LOW-level input voltage	$V_{CC} = 2.0\text{ V}$	-	0.8	0.5	-	0.5	-	0.5	V
		$V_{CC} = 4.5\text{ V}$	-	2.1	1.35	-	1.35	-	1.35	V
		$V_{CC} = 6.0\text{ V}$	-	2.8	1.8	-	1.8	-	1.8	V
$V_{OH}$	HIGH-level output voltage	$V_I = V_{IH}$ or $V_{IL}$								
		$I_O = -20\ \mu\text{A}; V_{CC} = 2.0\text{ V}$	1.9	2.0	-	1.9	-	1.9	-	V
		$I_O = -20\ \mu\text{A}; V_{CC} = 4.5\text{ V}$	4.4	4.5	-	4.4	-	4.4	-	V
		$I_O = -20\ \mu\text{A}; V_{CC} = 6.0\text{ V}$	5.9	6.0	-	5.9	-	5.9	-	V
		$I_O = -6.0\text{ mA}; V_{CC} = 4.5\text{ V}$	3.98	4.32	-	3.84	-	3.7	-	V
	$I_O = -7.8\text{ mA}; V_{CC} = 6.0\text{ V}$	5.48	5.81	-	5.34	-	5.2	-	V	

**Table 6. Static characteristics ...continued**

At recommended operating conditions; voltages are referenced to GND (ground = 0 V).

Symbol	Parameter	Conditions	25 °C			-40 °C to +85 °C		-40 °C to +125 °C		Unit
			Min	Typ	Max	Min	Max	Min	Max	
V <sub>OL</sub>	LOW-level output voltage	V <sub>I</sub> = V <sub>IH</sub> or V <sub>IL</sub>								
		I <sub>O</sub> = 20 μA; V <sub>CC</sub> = 2.0 V	-	0	0.1	-	0.1	-	0.1	V
		I <sub>O</sub> = 20 μA; V <sub>CC</sub> = 4.5 V	-	0	0.1	-	0.1	-	0.1	V
		I <sub>O</sub> = 20 μA; V <sub>CC</sub> = 6.0 V	-	0	0.1	-	0.1	-	0.1	V
		I <sub>O</sub> = 6.0 mA; V <sub>CC</sub> = 4.5 V	-	0.15	0.26	-	0.33	-	0.4	V
		I <sub>O</sub> = 7.8 mA; V <sub>CC</sub> = 6.0 V	-	0.16	0.26	-	0.33	-	0.4	V
I <sub>I</sub>	input leakage current	V <sub>I</sub> = V <sub>CC</sub> or GND; V <sub>CC</sub> = 6.0 V	-	-	±0.1	-	±1.0	-	±1.0	μA
I <sub>OZ</sub>	OFF-state output current	per input pin; V <sub>I</sub> = V <sub>IH</sub> or V <sub>IL</sub> ; V <sub>O</sub> = V <sub>CC</sub> or GND; other inputs at V <sub>CC</sub> or GND; V <sub>CC</sub> = 6.0 V; I <sub>O</sub> = 0 A	-	-	±0.5	-	±5.0	-	±10	μA
I <sub>CC</sub>	supply current	V <sub>I</sub> = V <sub>CC</sub> or GND; I <sub>O</sub> = 0 A; V <sub>CC</sub> = 6.0 V	-	-	8.0	-	80	-	160	μA
C <sub>I</sub>	input capacitance		-	3.5	-	-	-	-	-	pF
<b>74HCT240</b>										
V <sub>IH</sub>	HIGH-level input voltage	V <sub>CC</sub> = 4.5 V to 5.5 V	2.0	1.6	-	2.0	-	2.0	-	V
V <sub>IL</sub>	LOW-level input voltage	V <sub>CC</sub> = 4.5 V to 5.5 V	-	1.2	0.8	-	0.8	-	0.8	V
V <sub>OH</sub>	HIGH-level output voltage	V <sub>I</sub> = V <sub>IH</sub> or V <sub>IL</sub> ; V <sub>CC</sub> = 4.5 V								
		I <sub>O</sub> = -20 μA	4.4	4.5	-	4.4	-	4.4	-	V
		I <sub>O</sub> = -6 mA	3.98	4.32	-	3.84	-	3.7	-	V
V <sub>OL</sub>	LOW-level output voltage	V <sub>I</sub> = V <sub>IH</sub> or V <sub>IL</sub> ; V <sub>CC</sub> = 4.5 V								
		I <sub>O</sub> = 20 μA	-	0	0.1	-	0.1	-	0.1	V
		I <sub>O</sub> = 6.0 mA	-	0.16	0.26	-	0.33	-	0.4	V
I <sub>I</sub>	input leakage current	V <sub>I</sub> = V <sub>CC</sub> or GND; V <sub>CC</sub> = 5.5 V	-	-	±0.1	-	±1.0	-	±1.0	μA
I <sub>OZ</sub>	OFF-state output current	per input pin; V <sub>I</sub> = V <sub>IH</sub> or V <sub>IL</sub> ; V <sub>O</sub> = V <sub>CC</sub> or GND; other inputs at V <sub>CC</sub> or GND; V <sub>CC</sub> = 5.5 V; I <sub>O</sub> = 0 A	-	-	±0.5	-	±5.0	-	±10	μA
I <sub>CC</sub>	supply current	V <sub>I</sub> = V <sub>CC</sub> or GND; V <sub>CC</sub> = 5.5 V; I <sub>O</sub> = 0 A	-	-	8.0	-	80	-	160	μA
ΔI <sub>CC</sub>	additional supply current	per input pin; V <sub>I</sub> = V <sub>CC</sub> - 2.1 V; other inputs at V <sub>CC</sub> or GND; V <sub>CC</sub> = 4.5 V to 5.5 V; I <sub>O</sub> = 0 A								
		nAn or inputs	-	150	540	-	675	-	735	μA
		nOE input	-	70	252	-	315	-	343	μA
C <sub>I</sub>	input capacitance		-	3.5	-	-	-	-	-	pF

## 10. Dynamic characteristics

**Table 7. Dynamic characteristics**  
*GND = 0 V; for load circuit see Figure 8.*

Symbol	Parameter	Conditions	25 °C			-40 °C to +125 °C		Unit	
			Min	Typ	Max	Max (85 °C)	Max (125 °C)		
<b>74HC240</b>									
t <sub>pd</sub>	propagation delay	nAn to nYn; see <a href="#">Figure 6</a>	[1]						
		V <sub>CC</sub> = 2.0 V	-	30	100	125	150	ns	
		V <sub>CC</sub> = 4.5 V	-	11	20	25	30	ns	
		V <sub>CC</sub> = 5.0 V; C <sub>L</sub> = 15 pF	-	9	-	-	-	ns	
		V <sub>CC</sub> = 6.0 V	-	9	17	21	26	ns	
t <sub>en</sub>	enable time	n $\overline{O}E$ to nYn; see <a href="#">Figure 7</a>	[2]						
		V <sub>CC</sub> = 2.0 V	-	39	150	190	225	ns	
		V <sub>CC</sub> = 4.5 V	-	14	30	38	45	ns	
		V <sub>CC</sub> = 6.0 V	-	11	26	33	38	ns	
t <sub>dis</sub>	disable time	n $\overline{O}E$ to nYn or see <a href="#">Figure 7</a>	[3]						
		V <sub>CC</sub> = 2.0 V	-	41	150	190	225	ns	
		V <sub>CC</sub> = 4.5 V	-	15	30	38	45	ns	
		V <sub>CC</sub> = 6.0 V	-	12	26	33	38	ns	
t <sub>t</sub>	transition time	see <a href="#">Figure 6</a>	[4]						
		V <sub>CC</sub> = 2.0 V	-	14	60	75	90	ns	
		V <sub>CC</sub> = 4.5 V	-	5	12	15	18	ns	
		V <sub>CC</sub> = 6.0 V	-	4	10	13	15	ns	
C <sub>PD</sub>	power dissipation capacitance	per transceiver; V <sub>I</sub> = GND to V <sub>CC</sub>	[5]	-	30	-	-	-	pF

**Table 7. Dynamic characteristics ...continued**  
*GND = 0 V; for load circuit see Figure 8.*

Symbol	Parameter	Conditions	25 °C			-40 °C to +125 °C		Unit	
			Min	Typ	Max	Max (85 °C)	Max (125 °C)		
<b>74HCT240</b>									
$t_{pd}$	propagation delay	nAn to nYn; see <a href="#">Figure 6</a>	[1]						
		$V_{CC} = 4.5\text{ V}$	-	11	20	25	30	ns	
		$V_{CC} = 5.0\text{ V}; C_L = 15\text{ pF}$	-	9	-	-	-	ns	
$t_{en}$	enable time	nOE to nYn; $V_{CC} = 4.5\text{ V}$ ; see <a href="#">Figure 7</a>	[2]	-	13	30	38	45	ns
$t_{dis}$	disable time	nOE to nYn; $V_{CC} = 4.5\text{ V}$ ; see <a href="#">Figure 7</a>	[3]	-	13	25	31	38	ns
$t_t$	transition time	$V_{CC} = 4.5\text{ V}$ ; see <a href="#">Figure 6</a>	[4]	-	5	12	15	18	ns
$C_{PD}$	power dissipation capacitance	per transceiver; $V_I = \text{GND to } V_{CC} - 1.5\text{ V}$	[5]	-	30	-	-	-	pF

- [1]  $t_{pd}$  is the same as  $t_{PHL}$  and  $t_{PLH}$ .
- [2]  $t_{en}$  is the same as  $t_{PZH}$  and  $t_{PZL}$ .
- [3]  $t_{dis}$  is the same as  $t_{PHZ}$  and  $t_{PLZ}$ .
- [4]  $t_t$  is the same as  $t_{THL}$  and  $t_{TLH}$ .
- [5]  $C_{PD}$  is used to determine the dynamic power dissipation ( $P_D$  in  $\mu\text{W}$ ):  
 $P_D = C_{PD} \times V_{CC}^2 \times f_i \times N + \sum (C_L \times V_{CC}^2 \times f_o)$  where:  
 $f_i$  = input frequency in MHz;  
 $f_o$  = output frequency in MHz;  
 $C_L$  = output load capacitance in pF;  
 $V_{CC}$  = supply voltage in V;  
 $N$  = number of inputs switching;  
 $\sum (C_L \times V_{CC}^2 \times f_o)$  = sum of outputs.

## 11. Waveforms

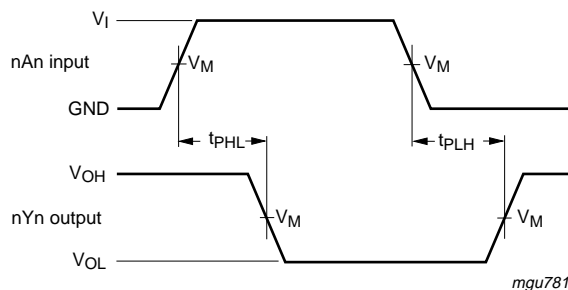

Measurement points are given in [Table 8](#).

$V_{OL}$  and  $V_{OH}$  are typical voltage output drop that occur with the output load.

**Fig 6. Input (nAn) to output (nYn) propagation delays and output transition times**



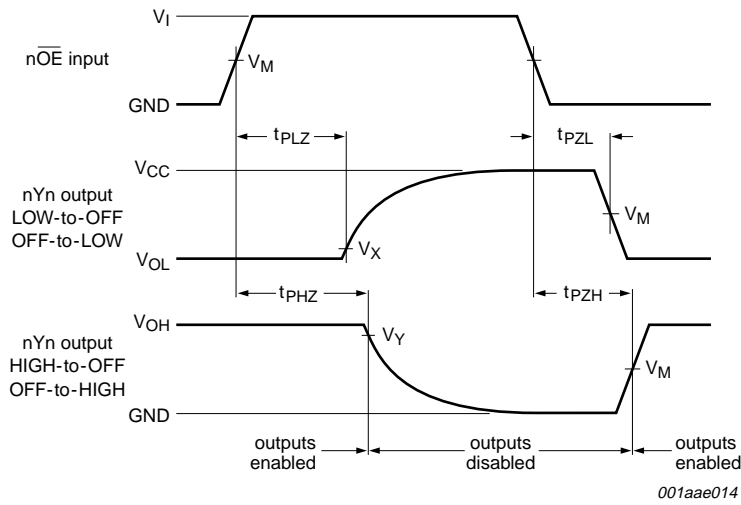

Measurement points are given in [Table 8](#).

$V_{OL}$  and  $V_{OH}$  are typical voltage output drop that occur with the output load.

**Fig 7. 3-state enable and disable times**

**Table 8. Measurement points**

Type	Input	Output		
	$V_M$	$V_M$	$V_X$	$V_Y$
74HC240	$0.5 \times V_{CC}$	$0.5 \times V_{CC}$	$0.1 \times V_{CC}$	$0.9 \times V_{CC}$
74HCT240	1.3 V	1.3 V	$0.1 \times V_{CC}$	$0.9 \times V_{CC}$

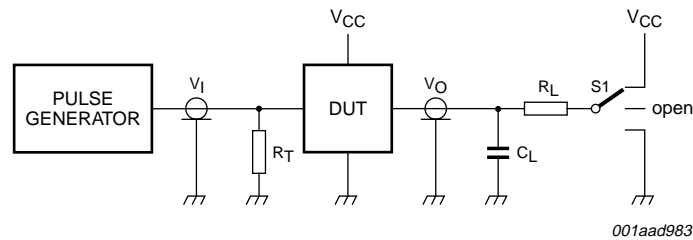
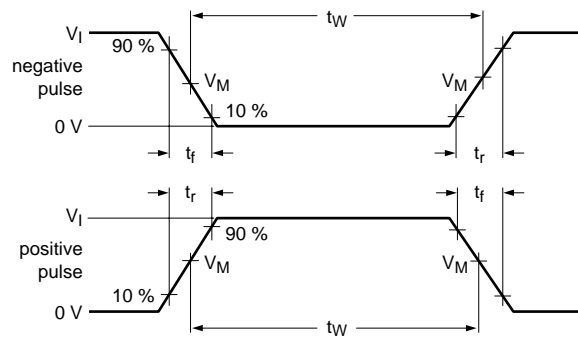

001aad983

Test data is given in [Table 9](#).

Definitions test circuit:

$R_T$  = Termination resistance should be equal to output impedance  $Z_o$  of the pulse generator.

$C_L$  = Load capacitance including jig and probe capacitance.

$R_L$  = Load resistance.

S1 = Test selection switch.

**Fig 8. Load circuitry for measuring switching times**

**Table 9. Test data**

Type	Input		Load		S1 position		
	$V_I$	$t_r, t_f$	$C_L$	$R_L$	$t_{PHL}, t_{PLH}$	$t_{PZH}, t_{PHZ}$	$t_{PZL}, t_{PLZ}$
74HC240	$V_{CC}$	6 ns	15 pF, 50 pF	1 k $\Omega$	open	GND	$V_{CC}$
74HCT240	3 V	6 ns	15 pF, 50 pF	1 k $\Omega$	open	GND	$V_{CC}$

12. Package outline

DIP20: plastic dual in-line package; 20 leads (300 mil)

SOT146-1

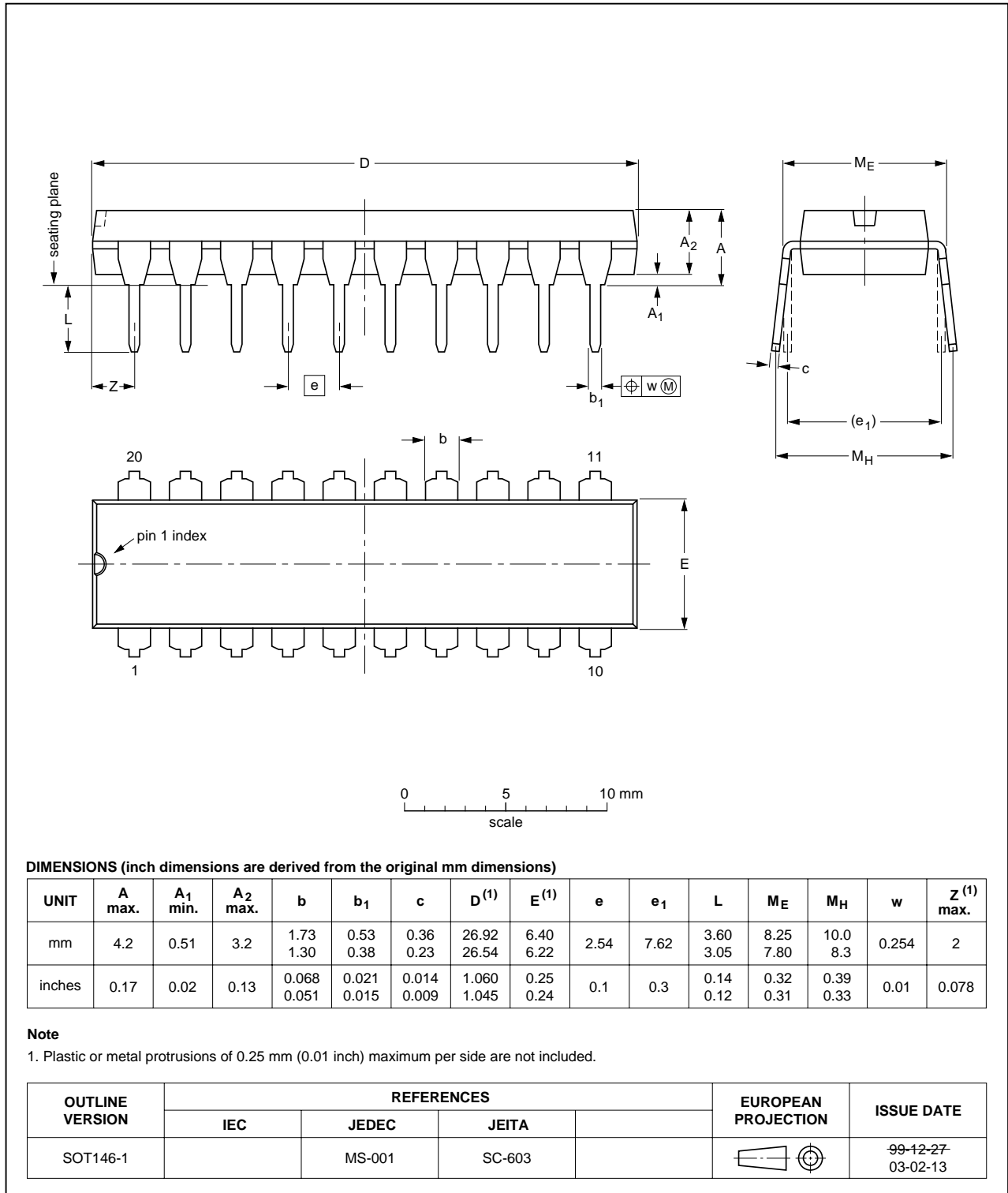

Fig 9. Package outline SOT146-1 (DIP20)

SO20: plastic small outline package; 20 leads; body width 7.5 mm

SOT163-1

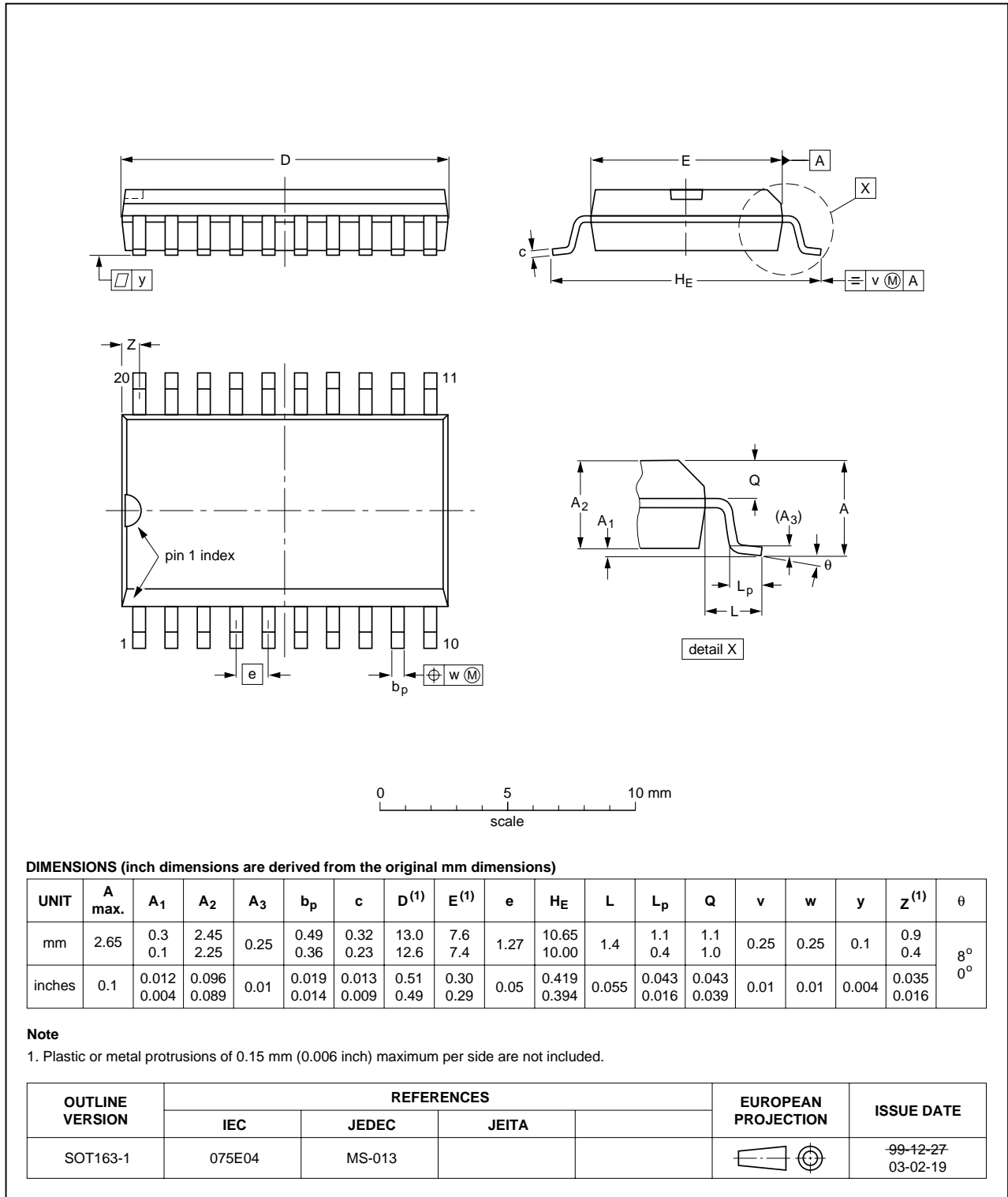

Fig 10. Package outline SOT163-1 (SO20)

SSOP20: plastic shrink small outline package; 20 leads; body width 5.3 mm

SOT339-1



Fig 11. Package outline SOT339-1 (SSOP20)

TSSOP20: plastic thin shrink small outline package; 20 leads; body width 4.4 mm

SOT360-1



Fig 12. Package outline SOT360-1 (TSSOP20)

DHVQFN20: plastic dual in-line compatible thermal enhanced very thin quad flat package; no leads; 20 terminals; body 2.5 x 4.5 x 0.85 mm

SOT764-1

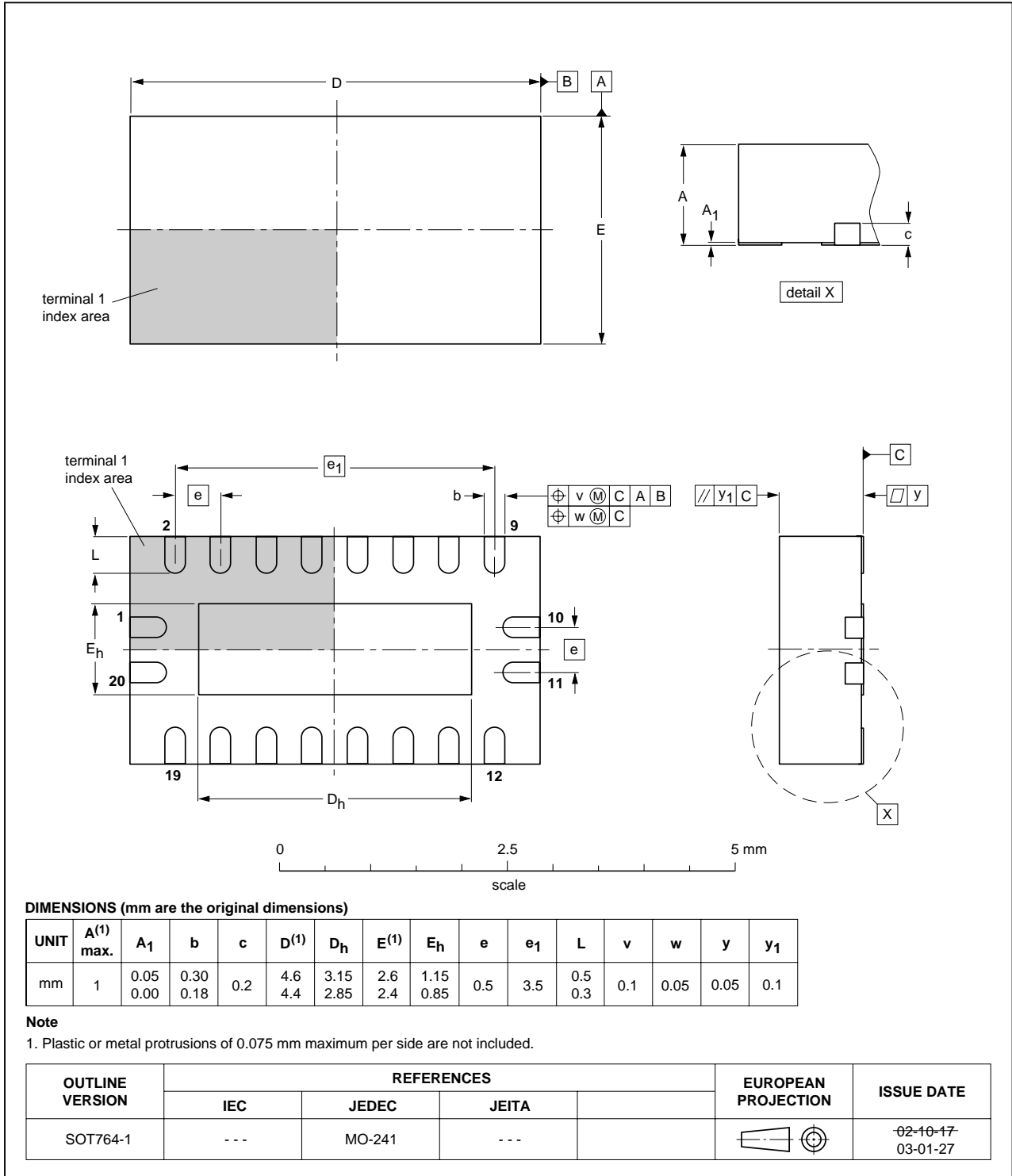

Fig 13. Package outline SOT764-1 (DHVQFN20)

## 13. Abbreviations

Table 10. Abbreviations

Acronym	Description
CMOS	Complementary Metal Oxide Semiconductor
DUT	Device Under Test
ESD	ElectroStatic Discharge
HBM	Human Body Model
MM	Machine Model
TTL	Transistor-Transistor Logic

## 14. Revision history

Table 11. Revision history

Document ID	Release date	Data sheet status	Change notice	Supersedes
74HC_HCT240_3	20070802	Product data sheet	-	74HC_HCT240_CNV_2
Modifications:		<ul style="list-style-type: none"><li>The format of this data sheet has been redesigned to comply with the new identity guidelines of NXP Semiconductors.</li><li>Legal texts have been adapted to the new company name where appropriate.</li><li>Added type number 74HC240BQ and 74HCT240BQ (DHVQFN20 package)</li></ul>		
74HC_HCT240_CNV_2	19970828	Product specification	-	-



## 15. Legal information

### 15.1 Data sheet status

Document status <sup>[1][2]</sup>	Product status <sup>[3]</sup>	Definition
Objective [short] data sheet	Development	This document contains data from the objective specification for product development.
Preliminary [short] data sheet	Qualification	This document contains data from the preliminary specification.
Product [short] data sheet	Production	This document contains the product specification.

[1] Please consult the most recently issued document before initiating or completing a design.

[2] The term 'short data sheet' is explained in section "Definitions".

[3] The product status of device(s) described in this document may have changed since this document was published and may differ in case of multiple devices. The latest product status information is available on the Internet at URL <http://www.nxp.com>.

### 15.2 Definitions

**Draft** — The document is a draft version only. The content is still under internal review and subject to formal approval, which may result in modifications or additions. NXP Semiconductors does not give any representations or warranties as to the accuracy or completeness of information included herein and shall have no liability for the consequences of use of such information.

**Short data sheet** — A short data sheet is an extract from a full data sheet with the same product type number(s) and title. A short data sheet is intended for quick reference only and should not be relied upon to contain detailed and full information. For detailed and full information see the relevant full data sheet, which is available on request via the local NXP Semiconductors sales office. In case of any inconsistency or conflict with the short data sheet, the full data sheet shall prevail.

### 15.3 Disclaimers

**General** — Information in this document is believed to be accurate and reliable. However, NXP Semiconductors does not give any representations or warranties, expressed or implied, as to the accuracy or completeness of such information and shall have no liability for the consequences of use of such information.

**Right to make changes** — NXP Semiconductors reserves the right to make changes to information published in this document, including without limitation specifications and product descriptions, at any time and without notice. This document supersedes and replaces all information supplied prior to the publication hereof.

**Suitability for use** — NXP Semiconductors products are not designed, authorized or warranted to be suitable for use in medical, military, aircraft, space or life support equipment, nor in applications where failure or

malfunction of a NXP Semiconductors product can reasonably be expected to result in personal injury, death or severe property or environmental damage. NXP Semiconductors accepts no liability for inclusion and/or use of NXP Semiconductors products in such equipment or applications and therefore such inclusion and/or use is at the customer's own risk.

**Applications** — Applications that are described herein for any of these products are for illustrative purposes only. NXP Semiconductors makes no representation or warranty that such applications will be suitable for the specified use without further testing or modification.

**Limiting values** — Stress above one or more limiting values (as defined in the Absolute Maximum Ratings System of IEC 60134) may cause permanent damage to the device. Limiting values are stress ratings only and operation of the device at these or any other conditions above those given in the Characteristics sections of this document is not implied. Exposure to limiting values for extended periods may affect device reliability.

**Terms and conditions of sale** — NXP Semiconductors products are sold subject to the general terms and conditions of commercial sale, as published at <http://www.nxp.com/profile/terms>, including those pertaining to warranty, intellectual property rights infringement and limitation of liability, unless explicitly otherwise agreed to in writing by NXP Semiconductors. In case of any inconsistency or conflict between information in this document and such terms and conditions, the latter will prevail.

**No offer to sell or license** — Nothing in this document may be interpreted or construed as an offer to sell products that is open for acceptance or the grant, conveyance or implication of any license under any copyrights, patents or other industrial or intellectual property rights.

### 15.4 Trademarks

Notice: All referenced brands, product names, service names and trademarks are the property of their respective owners.

## 16. Contact information

For additional information, please visit: <http://www.nxp.com>

For sales office addresses, send an email to: [salesaddresses@nxp.com](mailto:salesaddresses@nxp.com)

## 17. Contents

<b>1</b>	<b>General description</b> .....	<b>1</b>
<b>2</b>	<b>Features</b> .....	<b>1</b>
<b>3</b>	<b>Ordering information</b> .....	<b>1</b>
<b>4</b>	<b>Functional diagram</b> .....	<b>2</b>
<b>5</b>	<b>Pinning information</b> .....	<b>3</b>
5.1	Pinning .....	3
5.2	Pin description .....	3
<b>6</b>	<b>Functional description</b> .....	<b>4</b>
<b>7</b>	<b>Limiting values</b> .....	<b>4</b>
<b>8</b>	<b>Recommended operating conditions</b> .....	<b>5</b>
<b>9</b>	<b>Static characteristics</b> .....	<b>5</b>
<b>10</b>	<b>Dynamic characteristics</b> .....	<b>7</b>
<b>11</b>	<b>Waveforms</b> .....	<b>8</b>
<b>12</b>	<b>Package outline</b> .....	<b>11</b>
<b>13</b>	<b>Abbreviations</b> .....	<b>16</b>
<b>14</b>	<b>Revision history</b> .....	<b>16</b>
<b>15</b>	<b>Legal information</b> .....	<b>17</b>
15.1	Data sheet status .....	17
15.2	Definitions .....	17
15.3	Disclaimers .....	17
15.4	Trademarks .....	17
<b>16</b>	<b>Contact information</b> .....	<b>17</b>
<b>17</b>	<b>Contents</b> .....	<b>18</b>

Please be aware that important notices concerning this document and the product(s) described herein, have been included in section 'Legal information'.



© NXP B.V. 2007.

All rights reserved.

For more information, please visit: <http://www.nxp.com>

For sales office addresses, please send an email to: [salesaddresses@nxp.com](mailto:salesaddresses@nxp.com)

Date of release: 2 August 2007

Document identifier: 74HC\_HCT240\_3

## X-ON Electronics

Largest Supplier of Electrical and Electronic Components

*Click to view similar products for [Buffers & Line Drivers](#) category:*

*Click to view products by [NXP](#) manufacturer:*

Other Similar products are found below :

[5962-9217601MSA](#) [634810D](#) [875140G](#) [HEF4022BP](#) [HEF4043BP](#) [NL17SG125DFT2G](#) [NL17SZ126P5T5G](#) [NLU1GT126CMUTCG](#)  
[NLU3G16AMX1TCG](#) [NLV27WZ125USG](#) [MC74HCT365ADTR2G](#) [BCM6306KMLG](#) [54FCT240CTDB](#) [Le87401NQC](#) [Le87402MQC](#)  
[028192B](#) [042140C](#) [051117G](#) [070519XB](#) [065312DB](#) [091056E](#) [098456D](#) [NL17SG07DFT2G](#) [NL17SG17DFT2G](#) [NL17SG34DFT2G](#)  
[NL17SZ07P5T5G](#) [NL17SZ125P5T5G](#) [NLU1GT126AMUTCG](#) [NLV27WZ16DFT2G](#) [5962-8982101PA](#) [5962-9052201PA](#) [74LVC07ADR2G](#)  
[MC74VHC1G125DFT1G](#) [NL17SH17P5T5G](#) [NL17SZ125CMUTCG](#) [NLV17SZ07DFT2G](#) [NLV37WZ17USG](#) [NLVHCT244ADTR2G](#)  
[NC7WZ17FHX](#) [74HCT126T14-13](#) [NL17SH125P5T5G](#) [NLV14049UBDTR2G](#) [NLV37WZ07USG](#) [74VHC541FT\(BE\)](#) [RHFAC244K1](#)  
[74LVC1G17FW4-7](#) [74LVC1G126FZ4-7](#) [BCM6302KMLG](#) [74LVC1G07FZ4-7](#) [74LVC1G125FW4-7](#)