

# E Series OMNI-BEAM™ Sensors

OMNI-BEAM sensors with electromagnetic relay outputs



## Features

- SPDT electromechanical relay output for economy and high switching capacity
- Operate from 24 to 250V ac (50/60Hz) or from 24 to 36V dc; all sensing modes available
- Modular design with interchangeable components, optional Pulse or Delay timing logic modules
- Sense and Load output indicator LEDs
- Choice of prewired cable or SO-type quick-disconnect cable fitting
- Cross-hole design for front, back, or side mounting, plus 30mm threaded base mounting hub. Standard limit switch mounting hole spacing.



E71083 LR41887-17

Sensor Head Models	Sensing Mode	Range	Beam	Excess Gain	Beam Pattern
OSEE, OSER	<p>OPPOSED</p>	<p>45 m (150')</p> <p>Response: 20 ms ON/OFF Repeatability: 0.4 ms</p>	Infrared 880 nm		
OSED	<p>DIFFUSE</p>	<p>450 mm (18")</p> <p>Response: 20 ms ON/OFF Repeatability: 1 ms</p>	Infrared 880 nm		

**⚠ WARNING . . . Not To Be Used for Personnel Protection**





Never use these products as sensing devices for personnel protection. Doing so could lead to serious injury or death.

These sensors do NOT include the self-checking redundant circuitry necessary to allow their use in personnel safety applications. A sensor failure or malfunction can cause either an energized or de-energized sensor output condition. Consult your current Banner Safety Products catalog for safety products which meet OSHA, ANSI and IEC standards for personnel protection.

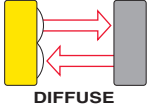
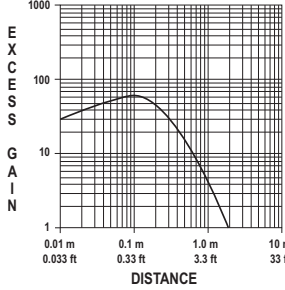
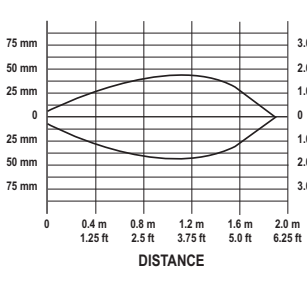

# E Series OMNI-BEAM™ Sensors

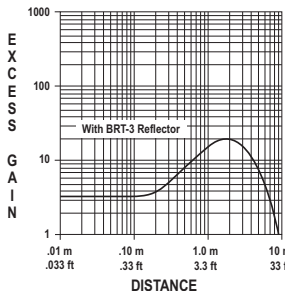
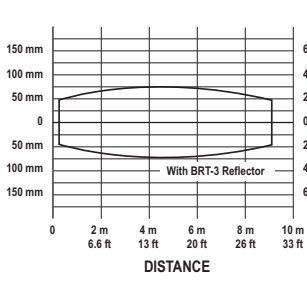
## Models, continued

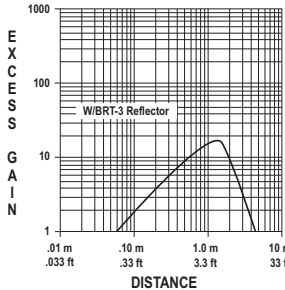
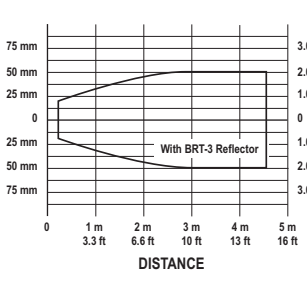
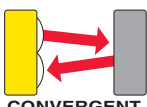
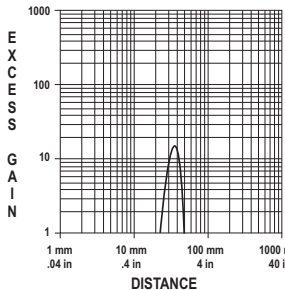
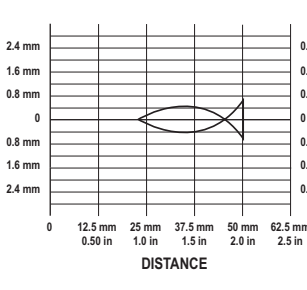
Sensor Head Models	Sensing Mode	Range	Beam	Excess Gain	Beam Pattern
OSEDX	 DIFFUSE	2 m (6')  Response: 20 ms ON/OFF Repeatability: 1 ms	Infrared 880 nm		
OSELV	 RETRO	0.15 to 9 m (6" to 3')  Response: 20 ms ON/OFF Repeatability: 1 ms	Visible red 650 nm		
OSELVAG	 POLAR RETRO Anti-Glare	0.3 to 4.5 m (12" to 15')  Response: 20 ms ON/OFF Repeatability: 1 ms	Visible red 650 nm		
OSECV	 CONVERGENT	Focus at 38 mm (1.5")  Response: 20 ms ON/OFF Repeatability: 1 ms	Visible Red 650 nm		

# E Series OMNI-BEAM™ Sensors

## Models, continued

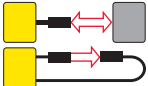
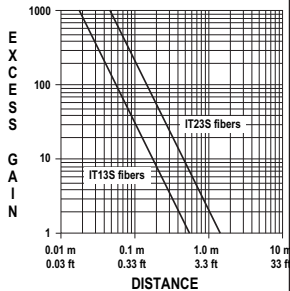
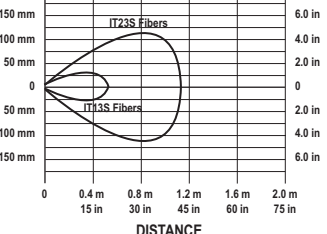
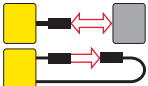
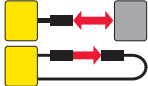
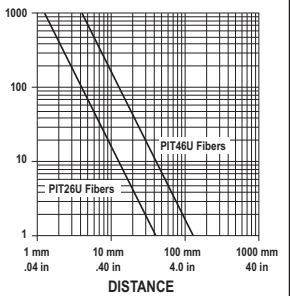
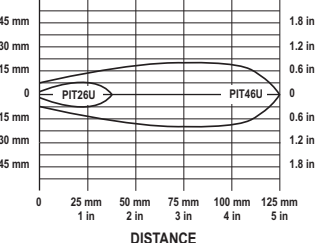
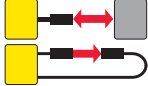
Sensor Head Models	Sensing Mode	Range	Beam	Excess Gain	Beam Pattern
OSEFX	 <p>GLASS FIBER Opposed Mode</p>	See Excess Gain curves	Infrared 880 nm		
	 <p>GLASS FIBER Diffuse Mode</p>			<p>Response: 20 ms ON/OFF Repeatability: 1 ms</p>	Infrared 880 nm
OSEFP	 <p>PLASTIC FIBER Opposed Mode</p>	See Excess Gain curves	Visible Red 650 nm		
	 <p>PLASTIC FIBER Diffuse Mode</p>			<p>Response: 20 ms ON/OFF Repeatability: 1 ms</p>	Visible Red 650 nm

# E Series OMNI-BEAM™ Sensors

Power Block Models	For Use With	Cable or Connector
OPEJ5	All but emitters	Prewired 6-foot PVC-jacketed 5-conductor cable.
OPEJ5QD		Integral minifast™ 5-conductor quick-disconnect cable fitting. Requires cable model MBCC-512, sold separately.
OPEJE	Emitters only, no output circuitry	Prewired 6-foot PVC-jacketed 2-conductor cable.
OPEJEQD		Integral minifast™ 5-conductor quick-disconnect cable fitting. Requires cable model MBCC-512, sold separately.

## Overview

Banner E Series OMNI-BEAM™ sensors are a line of modular, self-contained photoelectric sensors designed for applications where economy and performance are important. E Series OMNI-BEAMs have SPDT (single-pole double-throw, form “C”) electromechanical relay output and employ a power block that operates from either 24 to 250V ac or 24 to 36V dc. Sensing ranges of E Series OMNI-BEAMs are in most cases identical to those of standard model OMNI-BEAMs.

E Series OMNI-BEAM sensors have two major modules: a sensor head and a power block. (NOTE: sensor heads are interchangeable and are ordered individually.) LIGHT or DARK operate output is selected via an easily-accessible internal switch.

LED indicators for Sense and Load are located atop the sensor head beneath a transparent gasketed acrylic cover. Optional logic module boards slip easily into the sensor head and provide adjustable delay or adjustable pulse timer logic.

The Sense indicator lights whenever an object is sensed. The LOAD indicator lights whenever the sensor’s output relay is energized. This indicator is especially useful when a timing logic module is used and SENSE and LOAD conditions are not concurrent.

Their cross-hole mounting design with standard limit-switch hole spacing enables OMNI-BEAM E Series sensors to be mounted from the front, either side, or the back, making them ideal for conveyor and other production line applications. E Series OMNI-BEAMs may also be mounted using their 30mm threaded base mounting hub. A versatile 2-axis stainless steel accessory mounting bracket (model SMB30MM) and a PBT swivel-mount bracket (model SMB30SM) are available.

E Series opposed mode emitters use an emitter power block, either model OPEJE or OPEJEQD. All other E Series sensors use either model OPEJ5 or OPEJ5QD\*. Models OPEJE and OPEJ5 have a 1/2” NPS integral internal conduit thread and are supplied with a 6-foot PVC-covered cable. Models OPEJEQD and OPEJ5QD (“QD” models) have NEMA 4-rated quick-disconnect Mini-style connectors. All models are housed in tough, molded PBT housings. The power block electronics are epoxy-encapsulated. When assembled, all parts of E Series OMNI-BEAMs are fully gasketed.

### Diffuse Mode

Diffuse (proximity) mode sensors detect objects by sensing their own emitted light reflected from the object. They are ideal for use when the reflectivity and profile of the detected object is sufficient to return a large percentage of emitted light back to the sensor. Model OSEDX is the first choice for diffuse (proximity) mode applications when there are no background objects to falsely return light.

### Retroreflective

The visible red sensing beam of retroreflective sensors makes them very easy to align. The anti-glare model (suffix “AG”) polarizes the emitted light and filters out unwanted reflections, making sensing possible in otherwise unsuitable applications. Use “AG” models only in very clean environments and use with the model BRT-3 3” reflector. For detailed information on retroreflective targets, see the Banner Sensor catalog.

### Fiber Optic

Model OSEFX is an excellent choice for glass fiber optic applications compatible with the use of an infrared sensing beam and where faster sensor response is not required. Excess gain is very high; as a result, opposed individual fibers operate reliably in many hostile environments. Also, special miniature bifurcated fiber optic assemblies with bundle sizes as small as 0.5 mm (0.020”) in diameter may be used successfully for diffuse mode sensing. The excess gain curves and beam patterns illustrate response with standard 1.5 mm (0.060”) diameter and 3 mm (0.12”) diameter bundles. Response for smaller or larger bundle sizes may be interpolated.

Plastic fiber optics are lower in cost than glass fiber optics and are ideal for use in situations where the environmental conditions allow. They are easily cut to length in the field and are available in a variety of sensing end styles. For further information, refer to the Banner sensor catalog.

\* NOTE: E Series sensor heads may also be used with Standard OMNI-BEAM power blocks with solid-state output relay.

# E Series OMNI-BEAM™ Sensors

## Overview, continued

**Chemical resistance of plastic fiber optic assemblies:** contact with acids, strong bases (alkalis), and solvents will damage the monofilament optical fiber acrylic core. The polyethylene jacket protects the optical fiber from most chemical environments; however, materials may migrate through the jacket with long-term exposure. Samples of plastic fiber optic material are available from Banner for testing and evaluation.

### Power Blocks with SPDT Form "C" Electromechanical Relay Output

OMNI-BEAM E Series power blocks provide regulated low voltage dc power to the sensor head and logic module (if one is used), with input of 24 to 36V dc or 24 to 250V ac (50/60Hz). All power blocks, except those designed only to power emitters, have an internal electromechanical form "C" SPDT relay output.

Power blocks are epoxy-encapsulated and rated for 0° to +50° C (+32° to +122° F). They feature limit switch style cross-hole design for front, back, or side mounting, plus a 30 mm threaded hub for swivel bracket or through-hole mounting. Models include prewired cable or quick-disconnect (QD) fitting (see models table). Assembled sensors are rated NEMA 1, 2, 3, 3S, 4, 12, and 13.

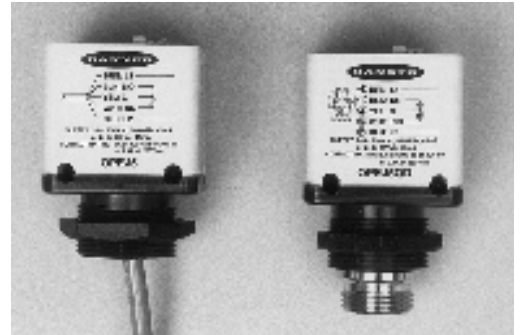

### Emitter Hookup to OPEJE and OPEJEQD Power Blocks

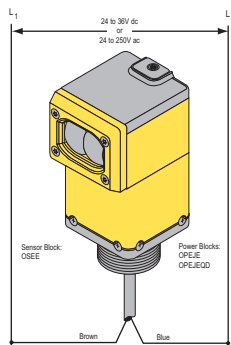

DC hookup is without regard to power supply polarity.

Note: Cordset model MBCC-5.. is sold separately for use with powerblock model OPEJEQD. It has five wires. The white, black, and yellow wires have no connection.

**NOTE: E Series OMNI-BEAM sensor heads may also be used with standard OMNI-BEAM power blocks with solid-state output relay.**

When E Series sensor heads are used with these power blocks, the power block Alarm output functions as a second load output that switches in parallel with the Load output (DPST). If the power block is a dc power block, neither output will have short-circuit or overload protection. E Series sensor heads do not have a D.A.T.A.™ display.

### Emitter Hookup to OPEJ5 and OPEJ5QD Power Blocks

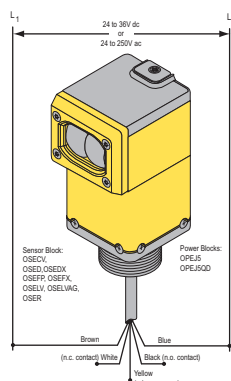

DC hookup is without regard to power supply polarity.

### Functional Schematic OPEJ5 and OPEJ5QD Power Blocks

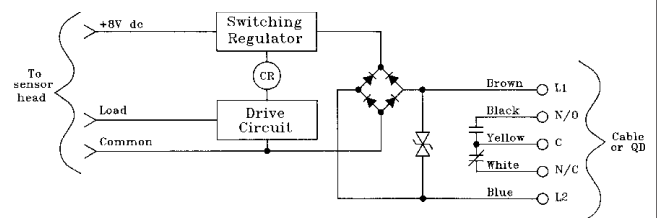

### Application caution - Power block models OPEJ5(QD) and OPEJE(QD)

Power block modules **OPEJ5(QD)** and **OPEJE(QD)** use "partial phase firing" power conversion to enable their wide range of ac input voltage (24 to 250V ac). AC power is applied to the sensor for only a small portion of each ac half-cycle. The current demand during this period may be as high as 1 to 2 amps per sensor.

The collective current demand of several of these sensors on a common ac line is significant. If several sensors are wired directly to the ac mains, it is unlikely that any adverse effects will be noticed. However, problems may be noticed if several sensors are connected to a common circuit that is isolated from the ac mains by a transformer. The collective peak current demand may rob other components on the same circuit of enough power to function properly. In the worst case, a transformer with inadequate reserve current capacity may overheat. Barring a transformer failure, the sensors themselves will operate normally.

NOTE: Peak power demand is not an issue when these power blocks are powered from direct current (24 to 36V dc).

# E Series OMNI-BEAM™ Sensors

## Overview, continued

### OMNI-BEAM Logic Modules

**E Series OMNI-BEAM sensors** easily accept the addition of timing logic when needed. Three multiple-function logic modules are available. Model **OLM5** is programmable for ON-delay, OFF-delay, or ON/OFF-delay timing logic. Models **OLM8** and **OLM8M1** offer either one-short or delayed one-shot functions. Programming of the logic function, the timing range, and the output state is done via a set of four switches located on the logic module.

Both logic modules feature 15-turn clutched potentiometers for accurate timing adjustments. The logic module simply slides into the sensor head housing and interconnects without wires. Timing adjustments are easily accessible at the top of the sensor head and are protected by the sensor head's transparent, gasketed polycarbonate cover. Assembled sensors are rated NEMA 1, 2, 3, 3S, 4, 12, and 13.

### OMNI-BEAM Logic Module Specifications

**Operating Temperature:** -40° to +70° C (-40° to +158° F)

**Timing Adjustments:** Two 15-turn clutched potentiometers with brass elements, accessible from outside at top of sensor block, beneath gasketed cover.

**Timing Repeatability:** Plus or minus 2% of timing range (maximum). Assumes conditions of constant temperature and power supply.

**Useful Time Range:** Useful range is from maximum time down to 10% of maximum, all models. When timing potentiometer is set fully counterclockwise, time will be approximately 1% of maximum for models **OLM5** and **OLM8**, and 2% of maximum for model **OLM8M1**.

**Response Time:** A disabled timing function adds no measurable sensing response time.

### OLM5 Delay Timer Logic Module

Model **OLM5** is programmable for ON-DELAY or OFF-DELAY or ON/OFF DELAY timing functions. Each delay function may be independently adjusted and separately programmed for either a long or short adjustment range.

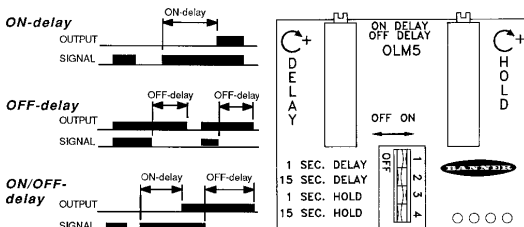

NOTE 1: if both ranges of either delay function are selected (i.e., if both 1 second and 15 second switches are "on"), the delay time range becomes 16 seconds, maximum.

NOTE 2: with switches #1 and #2 "off" (no ON-DELAY programmed), ON-DELAY is adjustable from "negligible" up to 100 milliseconds, maximum.

NOTE 3: with switches #3 and #4 "off" (no OFF-DELAY programmed), OFF-DELAY is adjustable from "negligible" up to 100 milliseconds, maximum.

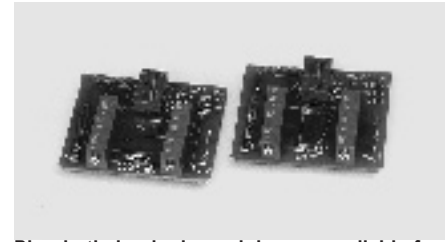

Plug-in timing logic modules are available for either delay or pulse timing functions.

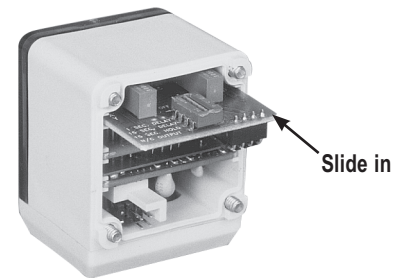

The logic module slides into the sensor head and interconnects without wires.

Timing Logic Function and Timing Range		Switch Positions			
		#1	#2	#3	#4
ON-DELAY	1 second maximum	ON	OFF	OFF	OFF
ON-DELAY	15 seconds maximum	OFF	ON	OFF	OFF
OFF-DELAY	1 second maximum	OFF	OFF	ON	OFF
OFF-DELAY	15 seconds maximum	OFF	OFF	OFF	ON
ON-DELAY OFF-DELAY	1 second maximum 1 second maximum	ON	OFF	ON	OFF
ON-DELAY OFF-DELAY	1 second maximum 15 seconds maximum	ON	OFF	OFF	ON
ON-DELAY OFF-DELAY	15 seconds maximum 1 second maximum	OFF	ON	ON	OFF
ON-DELAY OFF-DELAY	15 seconds maximum 15 seconds maximum	OFF	ON	OFF	ON

## Overview, continued

### OLM8 Pulse Timer Logic Module

Models **OLM8** and **OLM8M1** are programmable for either a one-shot ("single-shot") pulse timer or a delayed one-shot logic timer. Delay and Pulse times may be independently adjusted and separately configured for either a long or short adjustment range. **OLM8M1** maximum times are 1/10 those of the **OLM8**.

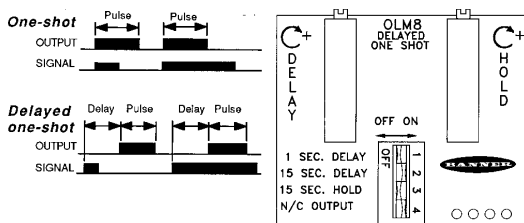

NOTE 1: DELAY is non-retriggerable.

PULSE is retriggerable if the DELAY time is less than the ONE-SHOT pulse time.

NOTE 2: if both ranges of the delay function are selected (i.e., if both 1 second and 15 second switches are "on"), the delay time range becomes 16 (1.6\*) seconds, maximum.

NOTE 3: with switches #1 and #2 "off" (no DELAY programmed), DELAY is adjustable from "negligible" up to 10 (4.5\*) milliseconds, maximum.

Logic Function and Timing Ranges: models OLM8 and OLM8M1*		Switch Positions			
		#1	#2	#3	#4
ONE-SHOT	1 (.1) second max. pulse	OFF	OFF	OFF	----
ONE-SHOT	15 (1.5) seconds max. pulse	OFF	OFF	ON	----
DELAYED	1 (.1) second max. delay	ON	OFF	OFF	----
ONE-SHOT	1 (.1) second max. pulse				
DELAYED	15 (1.5) seconds max. delay	OFF	ON	OFF	----
ONE-SHOT	1 (.1) second max. pulse				
DELAYED	1 (.1) second max. delay	ON	OFF	ON	----
ONE-SHOT	15 (1.5) seconds max. pulse				
DELAYED	15 (1.5) seconds max. delay	OFF	ON	ON	----
ONE-SHOT	15 (1.5) second max. pulse				

For normally open outputs (outputs conduct during pulse time) \_\_\_\_\_ OFF

For normally closed outputs (outputs open during pulse time) \_\_\_\_\_ ON

\*Timing specifications for model OLM8M1 are printed in *italics*.



# E Series OMNI-BEAM™ Sensors

## Configuration



### Light/Dark Operate Selection

Light- or dark-operate mode selection is done via a slide switch inside the bottom of the sensor head (see photo). To access the switch, first remove the transparent cover from the top of the sensor head, then unscrew the four captive assembly bolts that hold the sensor head to the power block. The switch is easily operated with a small screwdriver. Move the switch to the LEFT for LIGHT operate, or to the RIGHT for DARK operate (switch position information is inscribed on the printed circuit board, next to the switch).

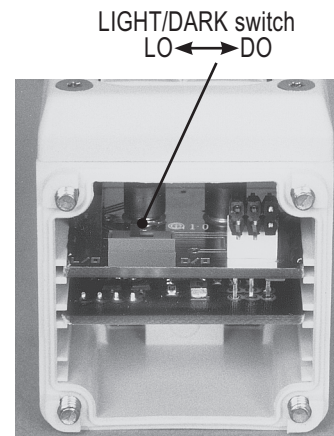
In LIGHT operate, the output is energized when the sensor “sees” light.  
In DARK operate, the output is energized when the sensor “sees” dark.



## Specifications

<b>Supply Voltage and Current</b>	24 to 250V ac (50-60 Hz), or 24 to 36V dc at 45 mA dc maximum, exclusive of load. DC hookup is without regard to polarity.
<b>Output Configuration</b>	One internal form “C” (single-pole double-throw) relay
<b>Output Rating</b>	<b>Maximum switching power (resistive load):</b> 150 W, 600 VA <b>Maximum switching voltage (resistive load):</b> 250V ac or 30V dc <b>Maximum switching current (resistive load):</b> 5 A <b>Minimum voltage and current:</b> 5V dc, 0.1 A <b>Mechanical life of relay:</b> 10,000,000 operations <b>Electrical life of relay at full resistive load:</b> 100,000 operations
<b>Output Response Time</b>	20 milliseconds ON and OFF; 100-millisecond delay on power-up (relay is de-energized during this period).
<b>Adjustments</b>	Multi-turn Gain control on top of sensor (beneath a transparent gasketed polycarbonate cover) allows precise sensitivity setting (turn clockwise to increase gain). Internal switch selects LIGHT operate or DARK operate. Optional logic module models <b>OLM5</b> , <b>OLM8</b> , and <b>OLM8M1</b> have adjustable timing functions.
<b>Indicators</b>	Red LED indicators for Sense and Load on top of sensor (beneath a transparent gasketed polycarbonate cover). Sense LED lights when an object is sensed. Load LED lights when the output relay is energized.
<b>Timing Logic</b>	Optional logic modules are available: timing logic module <b>OLM5</b> (DELAY timing logic) timing logic module <b>OLM8</b> or <b>OLM8M1</b> (PULSE timing logic)
<b>Construction</b>	Molded thermoplastic polyester housing. Power block is totally encapsulated. Molded acrylic lenses, stainless steel hardware. When assembled, all parts are fully gasketed. Assembled E Series OMNI-BEAM sensors are rated NEMA 1, 2, 3, 3S, 4, 12, and 13.
<b>Connections</b>	Sensors may be supplied either with 2-wire (for emitter models) and 5-wire (for all other models) 6' PVC-covered cable and 1/2" NPS integral internal conduit thread in the sensor base, or integral “QD” (quick disconnect) connector. “QD” models use 5-conductor cord sets MBCC-5.. (sold separately).
<b>Operating Conditions</b>	<b>Temperature:</b> 0° to +50° C (+32° to +122° F). <b>Temperature for Plastic Fiber Optics:</b> -30° to +70° C (-20° to +158° F)
<b>Certifications</b>	  E71083  LR41887-17



# E Series OMNI-BEAM™ Sensors

## Dimensions

Models OSEE, OSER, OSED, OSEDX, OSELV, OSELVAG\*, OSECV\*\*

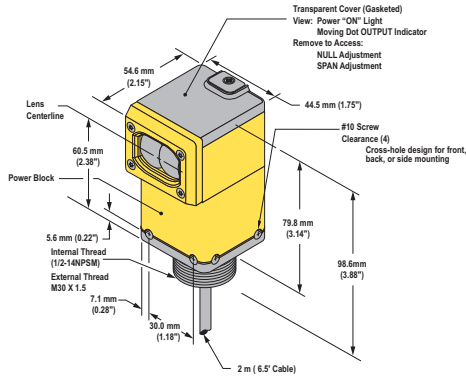

Model OSEFX

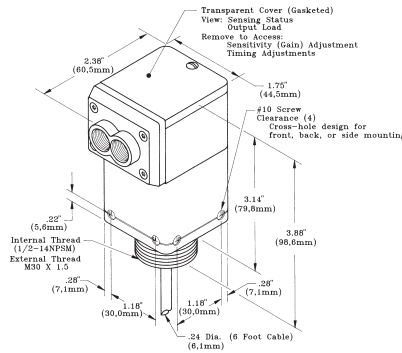

Model OSEFP

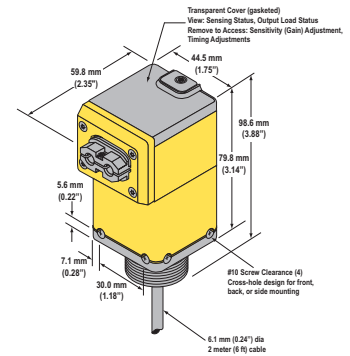

\* Depth of model OSELVAG is 57.7 mm (2.27")

\*\* Depth of model OSECV is 62.0 mm (2.44")

## Quick-Disconnect Cordsets

Style	Model	Length	Dimensions	Pinout
Mini-style 5-pin, straight connector	MBCC-506 MBCC-512 MBCC-530	2 m 4 m 9 m		<p><b>Key</b> 1 = brown 2 = white 3 = blue 4 = black 5 = yellow</p>

# E Series OMNI-BEAM™ Sensors

---



**WARRANTY:** Banner Engineering Corp. warrants its products to be free from defects for one year. Banner Engineering Corp. will repair or replace, free of charge, any product of its manufacture found to be defective at the time it is returned to the factory during the warranty period. This warranty does not cover damage or liability for the improper application of Banner products. This warranty is in lieu of any other warranty either expressed or implied.

P/N 03540 rev. C

Banner Engineering Corp., 9714 Tenth Ave. No., Minneapolis, MN USA 55441 • Phone: 763.544.3164 • [www.bannerengineering.com](http://www.bannerengineering.com) • Email: [sensors@bannerengineering.com](mailto:sensors@bannerengineering.com)

## X-ON Electronics

Largest Supplier of Electrical and Electronic Components

*Click to view similar products for [banner manufacturer](#):*

Other Similar products are found below :

[Q45VR2FPQ](#) [BTA23S](#) [RS-11](#) [L16F](#) [2LM3](#) [2PBA](#) [LM8-1](#) [LMT](#) [SM312CV](#) [SM31RQD](#) [LS4ELQ](#) [FX1](#) [Q45BB6LLQ](#) [QM42VP6AFV150Q](#)  
[D12SP6FP](#) [MBCC-412](#) [BA23S](#) [BT21S](#) [BTA13S](#) [LM4-2](#) [Q25SP6LPQ](#) [ES-FA-6G](#) [T183E](#) [SLSP30-600Q88](#) [SLSP30-1200Q88](#) [OPBA5](#)  
[PBAT](#) [SBLV1](#) [SMA91EQD](#) [SMA91E](#) [SMA912LVQD](#) [SMA912DQD](#) [SM2A312CVQD](#) [SM2A912LVQD](#) [SM31RL](#) [TL70RAQ](#) [TL70RQ](#)  
[K50LGRYPQ](#) [LEDRR70X70-78587](#) [BRT-THG-4X4-5](#) [T18-2VNDL-Q8](#) [SLLP14-1190P88](#) [SME312DQD](#) [SM312CUQD](#) [BR-2](#) [BR23P](#)  
[SM2A312FPQD](#) [SM2A312LVQD](#) [SM31EQD](#) [D12EP6FP](#)