

# OS Series Miniature Slide Switches

## Features/Benefits

- Variety of actuators & terminations
- PC and panel mounting
- Shorting or non-shorting contacts
- RoHS compliant
- Halogen free material

## Typical Applications

- Test & measurement equipment
- Computer peripherals & network products
- Consumer products



## Specifications

CONTACT RATING: See individual parts.  
 MECHANICAL & ELECTRICAL LIFE: 10,000 cycles.  
 CONTACT RESISTANCE: 20 mΩ or less.  
 INSULATION RESISTANCE: 100 MΩ min. at 500 VDC.  
 DIELECTRIC STRENGTH: 500 VAC for 1 minute.  
 OPERATING TEMPERATURE: -30°C to +70°C.  
 PACKAGING: Bulk

\* For RoHS compatible switches contact customer service.

## Materials

BASE: Phenolic resin.  
 ACTUATOR: POM, black.  
 HOUSING PLATE: Non-compatible; SPCC Sn plated.  
 Compatible; SPCC Ni plated.  
 MOVABLE CONTACT: Copper alloy, silver plated.  
 STATIONARY CONTACTS: Brass, silver plated.  
 TERMINALS: Brass, silver plated.  
 TERMINAL SEALED.

NOTE: Specifications and materials listed above are for switches with standard options. For information on specific and custom switches, consult Customer Service Center.

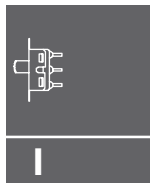

Slide

## How To Order

Complete part numbers for OS Series Slide Switches are shown on pages I-37 through I-43.

PART NUMBER			SWITCH FUNCTION	
	RoHS Compliant	RoHS Compatible	POS.1	POS.2
OS102011MS2QN1 (non-shorting)	YES	NO	ON	ON
OS102011MS2QN1C* (non-shorting)	YES	YES	ON	ON
OS102011MS2QS1 (shorting)	YES	NO	ON	ON
OS102011MS2QS1C* (shorting)	YES	YES	ON	ON
CONN. TERMINALS			1-2	2-3
SCHEMATIC				
SPDT				

CONTACT RATING: 0.1A @ 12 VDC

\* "C" option at the end of part number designates high temperature actuators

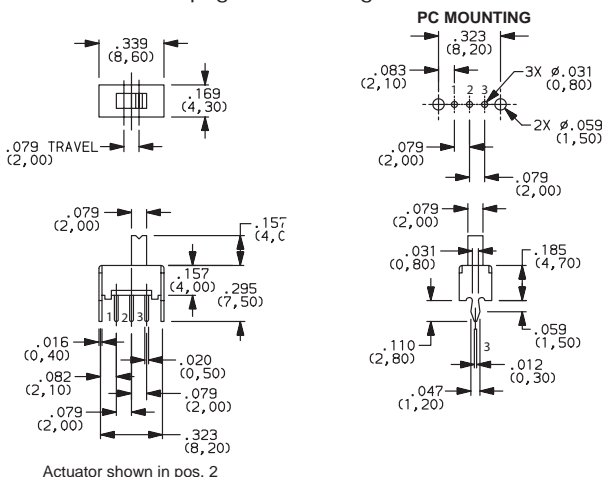

PART NUMBER			SWITCH FUNCTION		
	ROHS Compliant	ROHS Compatible	POS.1	POS.2	POS.3
OS103011MS8QP1 (Non-specified)	YES	NO	ON	ON	ON
OS103011MS8QP1C* (Non-specified)	YES	YES	ON	ON	ON
CONN. TERMINALS			1-2	2-3	2-4
SCHEMATIC					
SP3T					

CONTACT RATING: 0.1A @ 12 VDC

\* "C" option at the end of part number designates high temperature actuators

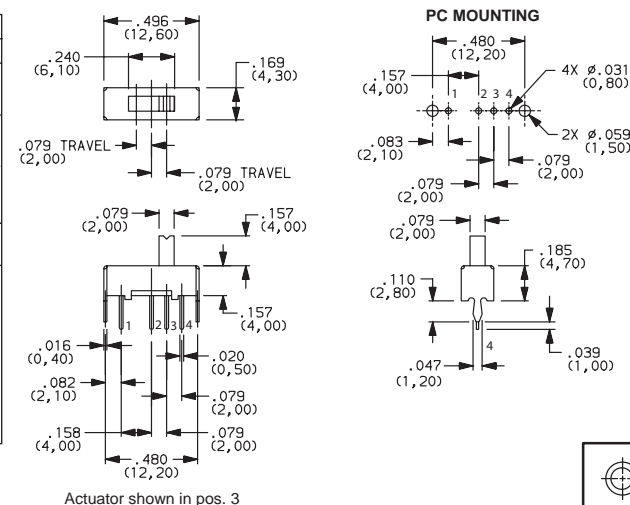

Dimensions are shown: Inches (mm)  
 Specifications and dimensions subject to change



9 nov 16

# OS Series Miniature Slide Switches



OS202011MS2QS1  
DPDT

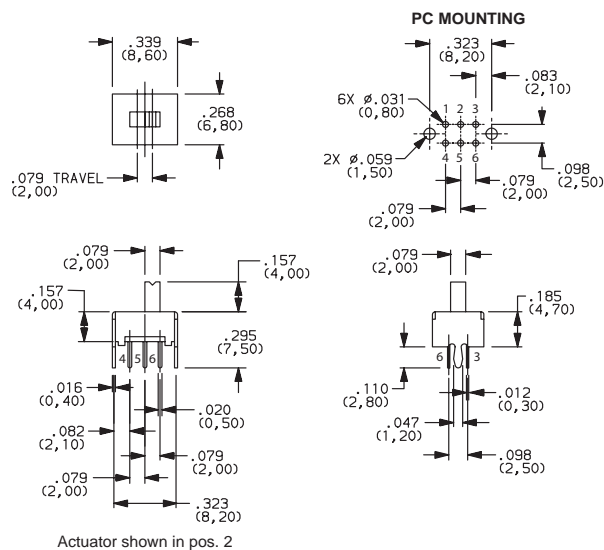

PART NUMBER	RoHS Compliant	RoHS Compatible	SWITCH FUNCTION	
			POS.1	POS.2
OS202011MS2QS1 (Shorting)	YES	NO	ON	ON
OS202011MS2QN1 (Non-shorting)	YES	NO	ON	ON
CONN. TERMINALS			1-2, 4-5	2-3, 5-6
SCHEMATIC				

CONTACT RATING: 0.1A @ 12 VDC



OS203011MS1QP1  
DP3T

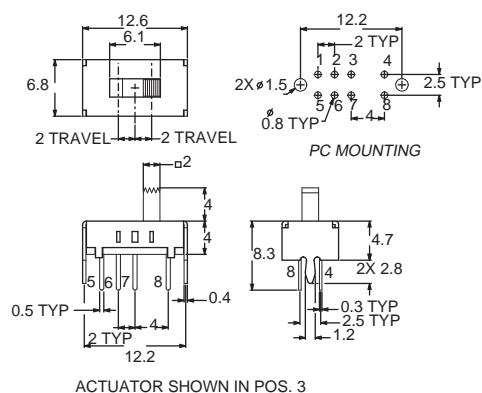

PART NUMBER	ROHS Compliant	ROHS Compatible	SWITCH FUNCTION		
			POS.1	POS.2	POS.3
OS203011MS1QP1 (Non-specified)	YES	NO	ON	ON	ON
CONN. TERMINALS			1-3, 5-7	2-3, 6-7	3-4, 7-8
SCHEMATIC					

CONTACT RATING: 0.3A @ 30 VDC



OS202013MT5QN1  
DPDT

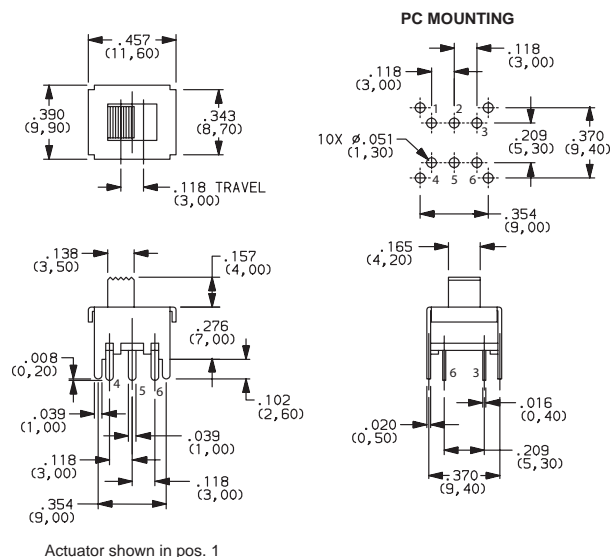

PART NUMBER	RoHS Compliant	RoHS Compatible	SWITCH FUNCTION	
			POS.1	POS.2
OS202013MT5QN1 (Non-shorting)	YES	NO	ON	ON
CONN. TERMINALS			1-2, 4-5	2-3, 5-6
SCHEMATIC				

CONTACT RATING: 0.3A @ 30 VDC

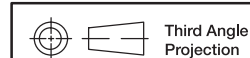

Dimensions are shown: Inch (mm)  
Specifications and dimensions subject to change



# OS Series Miniature Slide Switches

PART NUMBER	ROHS		SWITCH FUNCTION		
	Compliant	Compatible	POS.1	POS.2	POS.3
<b>OS203013MT7QN1</b> (Non-shorting)	YES	NO	ON	OFF	ON
<b>CONN. TERMINALS</b>			1-2, 4-5		2-3, 5-6
<b>SCHEMATIC</b>					
DP3T					

CONTACT RATING: 0.3A @ 30 VDC

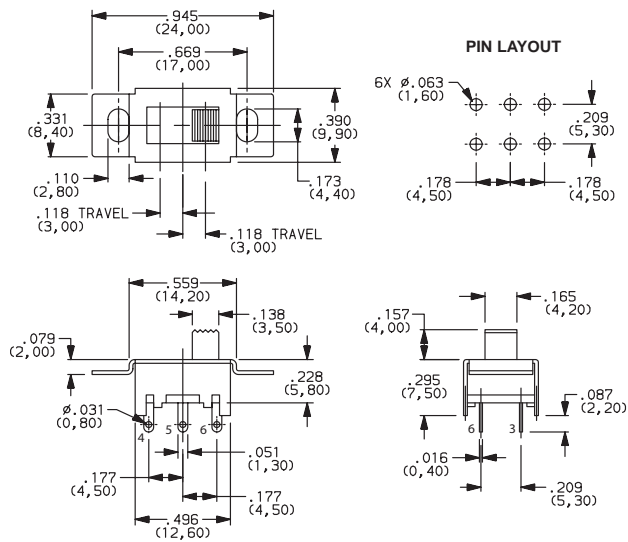

OS203013MT7QN1  
DP3T

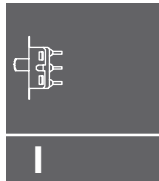

Slide

PART NUMBER	ROHS		SWITCH FUNCTION	
	Compliant	Compatible	POS.1	POS.2
<b>OS202013MT8QN1</b> (Non-shorting)	YES	NO	ON	ON
<b>CONN. TERMINALS</b>			1-2, 4-5	2-3, 5-6
<b>SCHEMATIC</b>				
DPDT				

CONTACT RATING: 0.3A @ 30 VDC

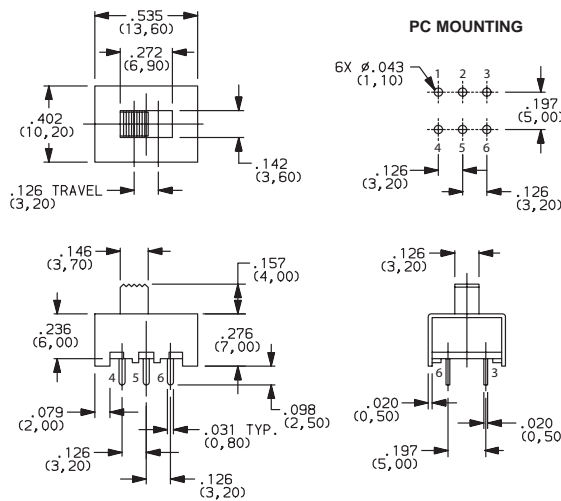

OS202013MT8QN1  
DPDT

PART NUMBER	ROHS		SWITCH FUNCTION		
	Compliant	Compatible	POS.1	POS.2	POS.3
<b>OS203013MT8QN1</b> (Non-shorting)	YES	NO	ON	ON	ON
<b>CONN. TERMINALS</b>			1-2, 5-6	2-3, 6-7	3-4, 7-8
<b>SCHEMATIC</b>					
DP3T					

CONTACT RATING: 0.3A @ 30 VDC

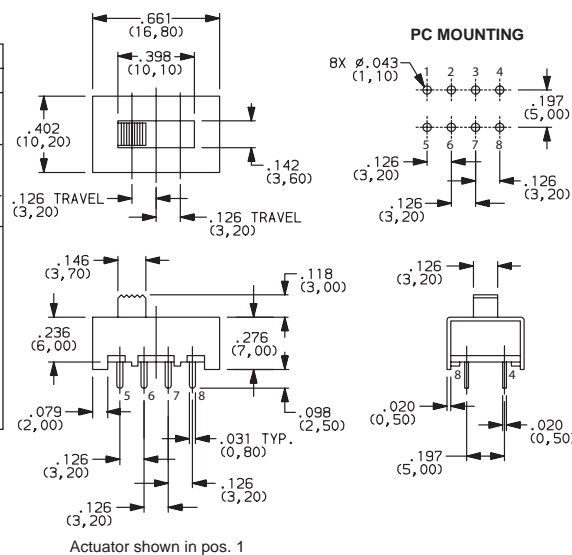

OS203013MT8QN1  
DP3T

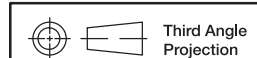

Dimensions are shown: Inches (mm)  
Specifications and dimensions subject to change



9 nov 16

# OS Series Miniature Slide Switches



OS203013MT6QN1  
DP3T

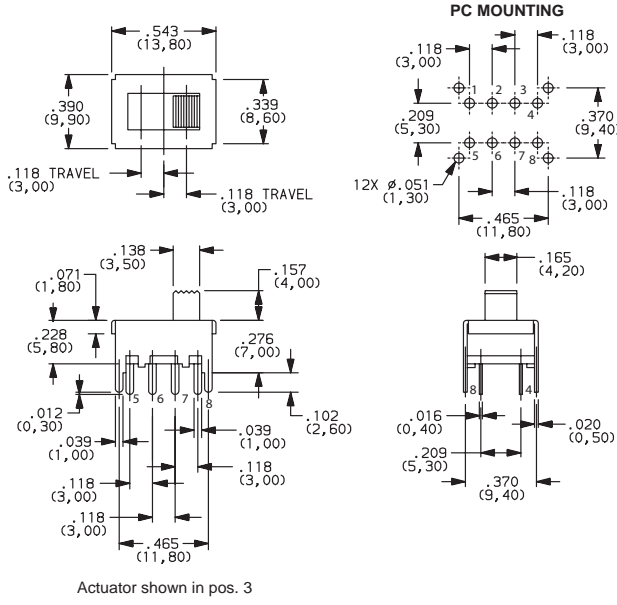

PART NUMBER	ROHS Compliant	ROHS Compatible	SWITCH FUNCTION		
			POS.1	POS.2	POS.3
OS203013MT6QN1 (Non-shorting)	YES	NO	ON	ON	ON
<b>CONN. TERMINALS</b>			1-2, 5-6	2-3, 6-7	3-4, 7-8
<b>SCHEMATIC</b>					
DP3T					

CONTACT RATING: 0.2A @ 30 VDC



OS103012MU1QP1  
SP3T

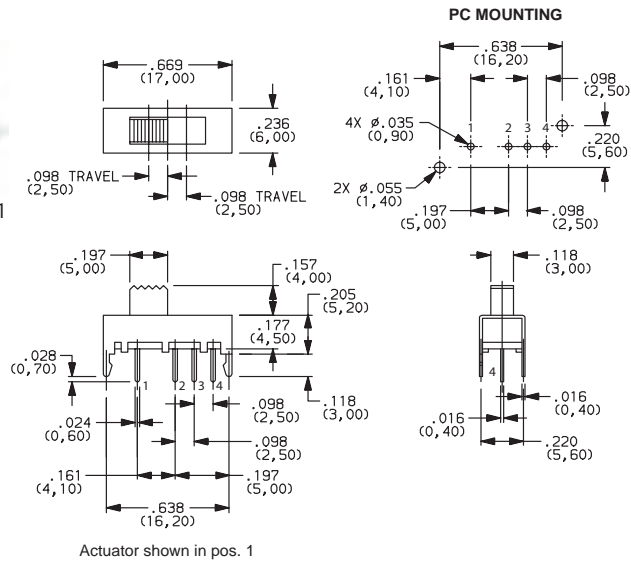

PART NUMBER	ROHS Compliant	ROHS Compatible	SWITCH FUNCTION		
			POS.1	POS.2	POS.3
OS103012MU1QP1 (Non-shorting)	YES	NO	ON	ON	ON
<b>CONN. TERMINALS</b>			1-2	2-3	2-4
<b>SCHEMATIC</b>					
SP3T					

CONTACT RATING: 0.2A @ 30 VDC



OS103012MU2QP1  
SP3T

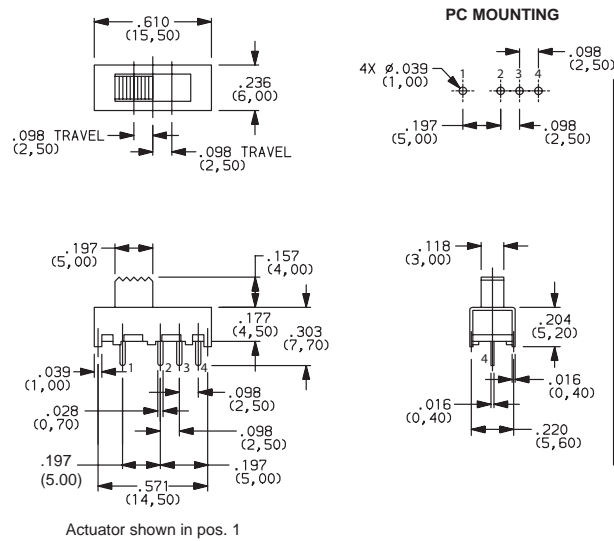

PART NUMBER	ROHS Compliant	ROHS Compatible	SWITCH FUNCTION		
			POS.1	POS.2	POS.3
OS103012MU2QP1 (Non-shorting)	YES	NO	ON	ON	ON
<b>CONN. TERMINALS</b>			1-2	2-3	2-4
<b>SCHEMATIC</b>					
SP3T					

CONTACT RATING: 0.2A @ 30 VDC



Dimensions are shown: Inch (mm)  
Specifications and dimensions subject to change



Slide

# OS Series Miniature Slide Switches

PART NUMBER	ROHS Compliant	ROHS Compatible	SWITCH FUNCTION		
			POS.1	POS.2	POS.3
<b>OS203012MU5QP1</b> (Non-specified)	YES	NO	ON	ON	ON
<b>CONN. TERMINALS</b>			1-2, 5-6	2-3, 6-7	2-4, 6-8
<b>SCHEMATIC</b>					
DP3T					

CONTACT RATING: 0.1A @ 30 VDC

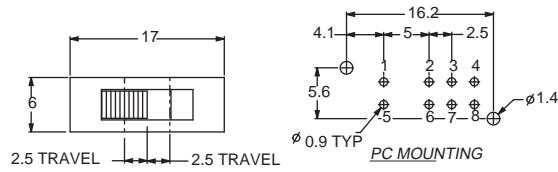

OS203012MU5QP1  
DP3T

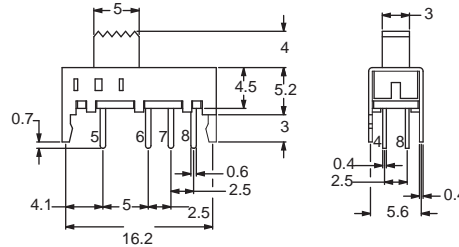

ACTUATOR SHOWN IN POS. 1

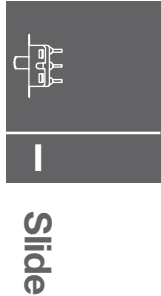

PART NUMBER	RoHS Compliant	RoHS Compatible	SWITCH FUNCTION	
			POS.1	POS.2
<b>OS202011MV4QN1</b> (Non-shorting)	YES	NO	ON	ON
<b>OS202011MV4QS1</b> (Shorting)	YES	NO	ON	ON
<b>CONN. TERMINALS</b>			1-2, 4-5	2-3, 5-6
<b>SCHEMATIC</b>				
DPDT				

CONTACT RATING: 0.1A @ 30 VDC

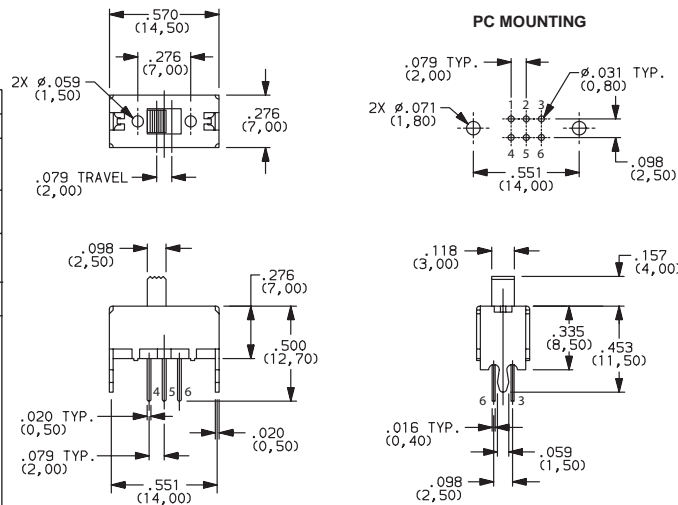

Actuator shown in pos. 1

OS202011MV4QN1  
DPDT

PART NUMBER	ROHS Compliant	ROHS Compatible	SWITCH FUNCTION		
			POS.1	POS.2	POS.3
<b>OS203011MV9QS1</b> (Shorting)	YES	NO	ON	ON	ON
<b>OS203011MV9QN1</b> (Non-Shorting)	YES	NO	ON	ON	ON
<b>CONN. TERMINALS</b>			1-2-5 6-7-10	1-3-5 6-8-10	1-4-5 6-9-10
<b>SCHEMATIC</b>					
DP3T					

CONTACT RATING: 0.1A @ 30 VDC

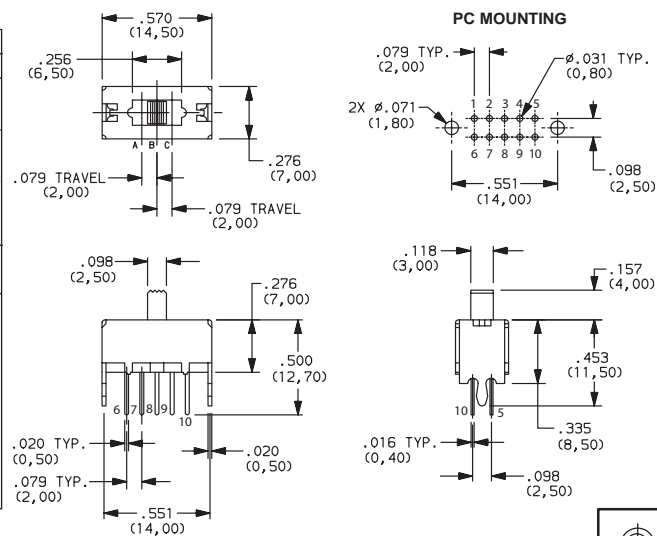

Actuator shown in pos. 2(A)

OS203011MV9QS1  
DP3T



Dimensions are shown: Inches (mm)

Specifications and dimensions subject to change



9 nov 16

# OS Series Miniature Slide Switches



OS102011MA1QN1  
SPDT

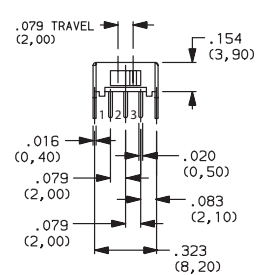
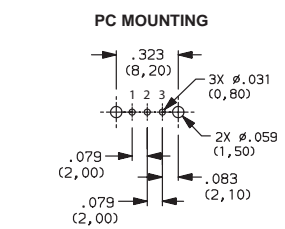
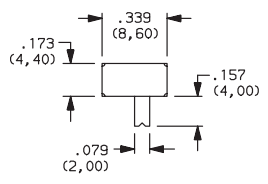

Actuator shown in pos. 2

PART NUMBER	SWITCH FUNCTION		POS.1	POS.2
	RoHS Compliant	RoHS Compatible		
OS102011MA1QN1 (Non-shorting)	YES	NO	ON	ON
OS102011MA1QN1C* (Non-shorting)	YES	YES	ON	ON
OS102011MA1QS1 (Shorting)	YES	NO	ON	ON
OS102011MA1QS1C* (Shorting)	YES	YES	ON	ON
CONN. TERMINALS			1-2	2-3
SCHEMATIC				
SPDT				

CONTACT RATING: 0.1A @ 12 VDC

\* "C" option at the end of part number designates high temperature actuators

Slide



OS103011MA7QP1  
SP3T

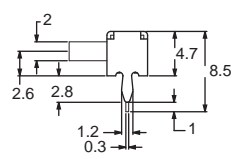
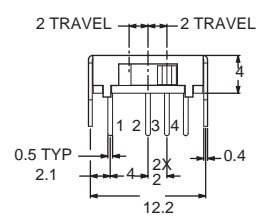
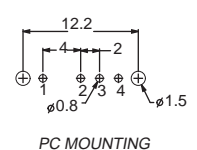
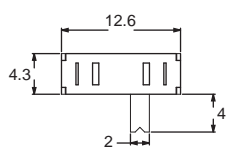

PART NUMBER	SWITCH FUNCTION				
	ROHS Compliant	ROHS Compatible	POS.1	POS.2	POS.3
OS103011MA7QP1 (Non-specified)	YES	NO	ON	ON	ON
OS103011MA7QP1C* (Non-specified)	YES	YES	ON	ON	ON
CONN. TERMINALS			1-2	2-3	2-4

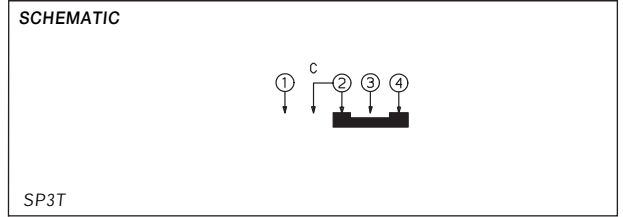

CONTACT RATING: 0.1A @ 12 VDC

\* "C" option at the end of part number designates high temperature actuators



OS203011MA2QP1  
DP3T

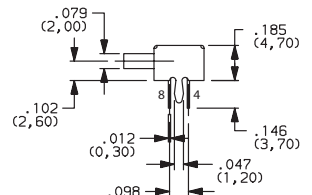
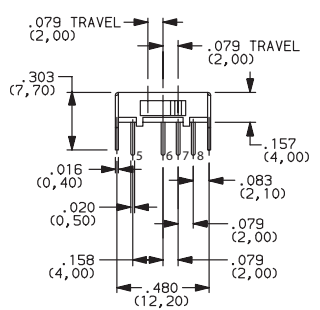
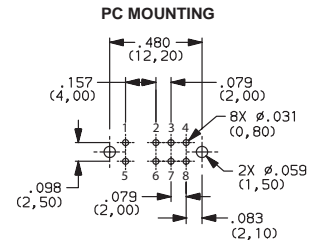
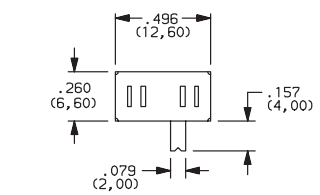

Actuator shown in pos. 3

PART NUMBER	SWITCH FUNCTION				
	ROHS Compliant	ROHS Compatible	POS.1	POS.2	POS.3
OS203011MA2QP1 (Non-specified)	YES	NO	ON	ON	ON
CONN. TERMINALS			1-2, 5-6	2-3, 6-7	2-4, 6-8
SCHEMATIC					
DP3T					

CONTACT RATING: 0.1A @ 12 VDC



# OS Series Miniature Slide Switches

PART NUMBER	RoHS Compliant	RoHS Compatible	SWITCH FUNCTION	
			POS.1	POS.2
OS202011MA0QN1 (Non-shorting)	YES	NO		
OS202011MA0QS1 (Shorting)	YES	NO		
CONN. TERMINALS			1-2, 4-5	2-3, 5-6
SCHEMATIC				
DPDT				

CONTACT RATING: 0.1A @ 12 VDC

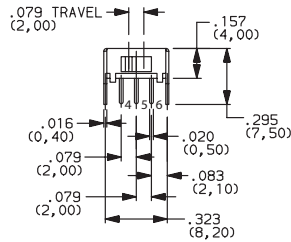
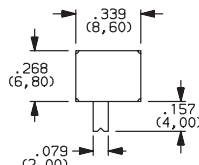

Actuator shown in pos. 1

## PC MOUNTING

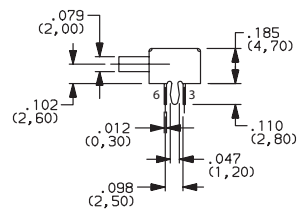
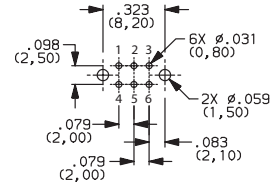

OS202011MA0QN1  
DPDT

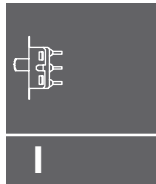

Slide

## X-ON Electronics

Largest Supplier of Electrical and Electronic Components

*Click to view similar products for [Slide Switches](#) category:*

*Click to view products by [C&K](#) manufacturer:*

Other Similar products are found below :

[6-1437581-1](#) [M43R](#) [MHS123K15D](#) [MHSS1104A](#) [MMD](#) [GH49S010001](#) [GH49WW00001](#) [1437576-8](#) [EPS1PC1](#) [1825074-1](#) [1825160-3](#)  
[1825167-2](#) [25139NLDB](#) [25436NLDB](#) [25449NAH](#) [25536NA](#) [L101011ML04B](#) [SLB1240R45](#) [SLSA12004](#) [1825078-1](#) [1825080-4](#) [1825081-1](#)  
[1825269-1](#) [1825270-2](#) [STS141RA04](#) [T2215BEN506](#) [GF-124-0204](#) [GH46P000001](#) [GH46W000001](#) [GH49P010001](#) [25339NA](#) [25436NLDH](#)  
[CST91246FK](#) [TG36P000000](#) [TG36P000050](#) [47227LFE](#) [49331L](#) [MHSS1105A](#) [50208L](#) [HW4S-5LF22N3](#) [L202091MS02Q](#) [4-1437581-7](#)  
[X2225CR-437W](#) [48BFSP3M2QT](#) [49329L](#) [1101M1S3ZB8E2](#) [1-1437581-1](#) [EG1218REDACTUATOR](#) [TG39W000000](#) [1825075-1](#)