

# EPIC® H-A 3 Housings

Innovative metal and plastic housing design



## H-A Hood straight cable entry

### Suitable inserts:

- EPIC® H-A 3 see page 430
- EPIC® H-D 7 see page 437
- EPIC® H-Q 5 see page 436
- EPIC® STA 6 Screw termination see page 433
- EPIC® H-A 4 see page 430
- EPIC® H-D 8 see page 437
- EPIC® STA 6 Solder termination see page 433

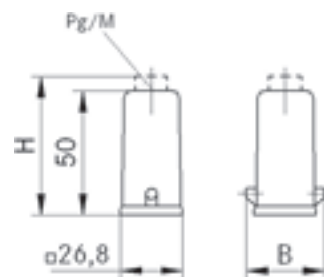

## H-A Hood side cable entry

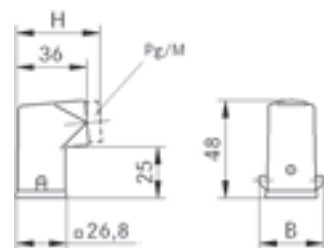

Part number	Part	PG	M	Material	Colour	Cable gland	B	H
<b>H-A housing: Hood (straight cable entry)</b>								
10512100	H-A 3 M Tgv	11		Zinc die-casting	grey		33,5	
10425500	H-A 3 Tgv	11		Thermoplastic	black		36	
10426000	H-A 3 Tgv	11		Thermoplastic	grey		36	
10426500	H-A 3 M Tgv	11		Zinc die-casting	grey	yes	33,5	57
10426700	H-A 3 Tgv	11		Thermoplastic	black	yes	36	62
10426400	H-A 3 Tgv	11		Thermoplastic	grey	yes	36	62
19512100	H-A 3 M Tgv M20		20	Zinc die-casting	grey		33,5	
19425500	H-A 3 Tgv M20		20	Thermoplastic	black		36	
19426000	H-A 3 Tgv M20		20	Thermoplastic	grey		36	
19426500	H-A 3 M Tgv M20		20	Zinc die-casting	grey	yes	33,5	57
<b>H-A housing: Hood (side cable entry)</b>								
10512300	H-A 3 M Ts	11		Zinc die-casting	grey		33,5	
10427300	H-A 3 Ts	11		Thermoplastic	black		36	
10427000	H-A 3 Ts	11		Thermoplastic	grey		36	
10427500	H-A 3 M Ts	11		Zinc die-casting	grey	yes	33,5	43
10620600	H-A 3 Ts	11		Thermoplastic	black	yes	36	48
10427100	H-A 3 Ts	11		Thermoplastic	grey	yes	36	48
19512300	H-A 3 M Ts		20	Zinc die-casting	grey		33,5	
19427300	H-A 3 Ts		20	Thermoplastic	black		36	
19427000	H-A 3 Ts		20	Thermoplastic	grey		36	
19427500	H-A 3 M Ts		20	Zinc die-casting	grey	yes	33,5	43

# EPIC® H-A 3 Housings

Innovative metal and plastic housing design



## H-A Surface Mount Base

1 cable inlet

### Suitable inserts:

- EPIC® H-A 3 see page 430
- EPIC® H-D 7 see page 437
- EPIC® H-Q 5 see page 436
- EPIC® STA 6 Screw termination see page 433
- EPIC® H-A 4 see page 430
- EPIC® H-D 8 see page 437
- EPIC® STA 6 Solder termination see page 433

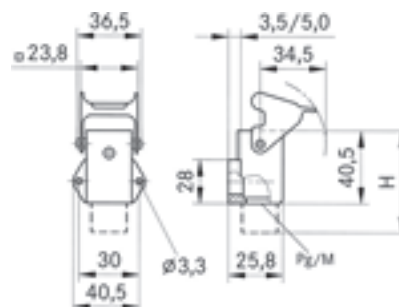
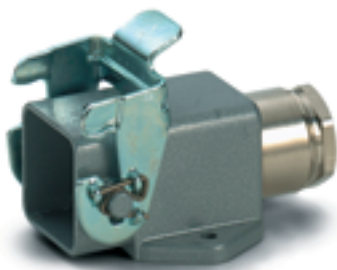

## H-A Surface Mount Base

with open bottom

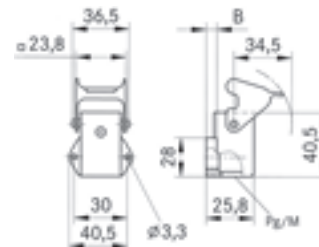

## H-A 3 Cable Coupler Hood

straight entry

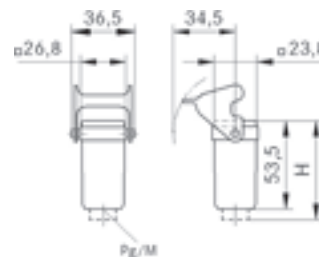

Part number	Part	PG	M	Material	Colour	Cable gland	B	H
<b>H-A housing: Surface mount base</b>								
10512700	H-A 3 MAgsv	11		Zinc die-casting	grey		3,5	51,5
10424000	H-A 3 Agsv	11		Thermoplastic	grey		5,0	56
10424500	H-A 3 MAgsv	11		Zinc die-casting	grey	yes	3,5	57,5
10424200	H-A 3 Agsv	11		Thermoplastic	grey	yes	5,0	65
19512700	H-A 3 MAgsv M20		20	Zinc die-casting	grey		3,5	54,5
19421900	H-A 3 Agsv M20		20	Thermoplastic	grey	yes	5,0	56
19424500	H-A 3 MAgsv M20		20	Zinc die-casting	grey	yes	3,5	60,5
<b>H-A housing: Surface mount base (with open bottom)</b>								
19517200	H-A 3 MAgsv M20		20	Zinc die-casting	grey		3,5	
19515200	H-A 3 Agsv M20		20	Thermoplastic	grey		5,0	
<b>H-A housing: Cable coupler hood (straight cable entry)</b>								
10512900	H-A 3 MTgvb	11		Zinc die-casting	grey			
10429200	H-A 3 Tgvb	11		Thermoplastic	black			
10429000	H-A 3 Tgvb	11		Thermoplastic	grey			
10429500	H-A 3 MTgvb	11		Zinc die-casting	grey	yes		60
10620300	H-A 3 Tgvb	11		Thermoplastic	black	yes		65
10429100	H-A 3 Tgvb	11		Thermoplastic	grey	yes		65
19512900	H-A 3 MTgvb M20		20	Zinc die-casting	grey			
19429000	H-A 3 Tgvb M20		20	Thermoplastic	grey			
19429200	H-A 3 Tgvb M20		20	Thermoplastic	black			

# EPIC® H-A Inserts

H-A Inserts with screw termination up to 2.5 mm<sup>2</sup> wire cross section



## H-A 3 screw termination

The H-A 3 are used wherever space is at a minimum. Screw termination with straight cable insertion from the rear  
 Ranges of application:  
 Machine and apparatus construction, control technology

### Suitable housing:

EPIC® H-A 3 Housings see page 472

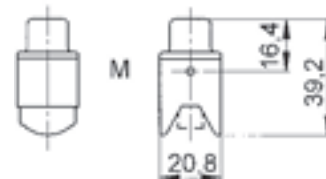
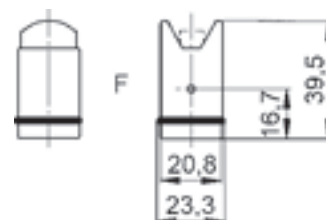

## H-A 4 screw termination

The small H-A 4 are used wherever space is at a minimum. Screw termination with straight cable insertion from the rear  
 Ranges of application:  
 Machine and apparatus construction, control technology

### Suitable housing:

EPIC® H-A 3 Housings see page 472

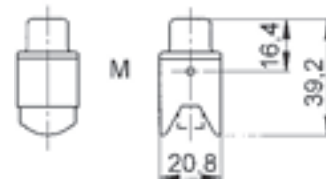
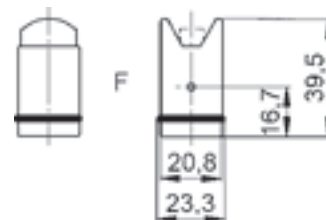

## Technical Data

Rated voltage  
 IEC: 400 V  
 UL: 600 V  
 CSA: 600 V

Rated impulse Voltage  
 4 kV

Rated current  
 IEC: 23 A  
 UL: 10 A  
 CSA: 10 A

Pollution degree  
 3; according to DIN EN 61984  
 sect. 6.19.2.2, at least one  
 protection degree of IP 54 must  
 be complied with

Contact resistance  
 1.5 - 4 mOhm

Contacts  
 Copper alloy, hard silver plated

Numbers of contacts  
 EPIC® H-A 3  
 3 + PE  
 EPIC® H-A 4  
 4 + PE

Termination methods  
 Screw termination: 0.5 - 2.5 mm<sup>2</sup>  
 (2.5 mm<sup>2</sup> only without conductor  
 end sleeves)

Cycle of mechanical operation  
 100

Range of temperature  
 -40°C - +100°C, temporary up  
 to +125°C

Part number	Part	Version	Contacts
<b>H-A 3 screw termination</b>			
10420000	H-A 3 SS		male 1 - 3
10421000	H-A 3 BS		female 1 - 3
<b>H-A 4 screw termination</b>			
10431000	H-A 4 SS		male 1 - 4
10432000	H-A 4 BS		female 1 - 4

# SKINTOP® ST-M / STR-M / ST M ISO / STR M ISO

Cable gland in acc. with EN 50262 for fast assembly



Part number	Part designation / size	Clamping range F mm	SW mm	C mm	D mm	PU pieces
53111220	ST-M 20 x 1.5	7 - 13	25	37	9	100
53111230	ST-M 25 x 1.5	9 - 17	30	40	10	50
53111240	ST-M 32 x 1.5	11 - 21	36	47	10	25
53111250	ST-M 40 x 1.5	19 - 28	46	52	10	10
53111260	ST-M 50 x 1.5	27 - 35	55	62	12	5
53111270	ST-M 63 x 1.5	34 - 45	66	71	12	5
<b>SKINTOP® ST-M light grey</b>						
53111400	ST-M 12 x 1.5	3,5 - 7	15	30	8	100
53111410	ST-M 16 x 1.5	4,5 - 10	19	34	8	100
53111420	ST-M 20 x 1.5	7 - 13	25	37	9	100
53111430	ST-M 25 x 1.5	9 - 17	30	40	10	50
53111440	ST-M 32 x 1.5	11 - 21	36	47	10	25
53111450	ST-M 40 x 1.5	19 - 28	46	52	10	10
53111460	ST-M 50 x 1.5	27 - 35	55	62	12	5
53111470	ST-M 63 x 1.5	34 - 45	66	71	12	5
<b>SKINTOP® ST M ISO silver-grey (with long metric connecting thread)</b>						
53017010	ST M 16 x 1.5	3,5 - 8	19	40	13	100
53017030	ST M 20 x 1.5	5 - 12	24	45	13	100
53017040	ST M 25 x 1.5	9 - 14	27	47	13	50
<b>SKINTOP® ST M ISO black (with long metric connecting thread)</b>						
53017210	ST M 16 x 1.5	3,5 - 8	19	40	13	100
53017230	ST M 20 x 1.5	5 - 12	24	45	13	100
53017240	ST M 25 x 1.5	9 - 14	27	47	13	50
<b>SKINTOP® STR-M silver-grey</b>						
53111100	STR-M 12 x 1.5	1 - 5	15	30	8	100
53111110	STR-M 16 x 1.5	2 - 7	19	34	8	100
53111120	STR-M 20 x 1.5	5 - 10	25	37	9	100
53111130	STR-M 25 x 1.5	6 - 13	30	40	10	50
53111140	STR-M 32 x 1.5	7 - 15	36	47	10	25
53111150	STR-M 40 x 1.5	15 - 23	46	52	10	10
53111160	STR-M 50 x 1.5	22 - 29	55	62	12	5
53111170	STR-M 63 x 1.5	28 - 39	66	71	12	5
<b>SKINTOP® STR-M black</b>						
53111300	STR-M 12 x 1.5	1 - 5	15	30	8	100
53111310	STR-M 16 x 1.5	2 - 7	19	34	8	100
53111320	STR-M 20 x 1.5	5 - 10	25	37	9	100
53111330	STR-M 25 x 1.5	6 - 13	30	40	10	50
53111340	STR-M 32 x 1.5	7 - 15	36	47	10	25
53111350	STR-M 40 x 1.5	15 - 23	46	52	10	10
53111360	STR-M 50 x 1.5	22 - 29	55	62	12	5
53111370	STR-M 63 x 1.5	28 - 39	66	71	12	5
<b>SKINTOP® STR-M light grey</b>						
53111500	STR-M 12 x 1.5	1 - 5	15	30	8	100
53111510	STR-M 16 x 1.5	2 - 7	19	34	8	100
53111520	STR-M 20 x 1.5	5 - 10	25	37	9	100
53111530	STR-M 25 x 1.5	6 - 13	30	40	10	50
53111540	STR-M 32 x 1.5	7 - 15	36	47	10	25
53111550	STR-M 40 x 1.5	15 - 23	46	52	10	10
53111560	STR-M 50 x 1.5	22 - 29	55	62	12	5
53111570	STR-M 63 x 1.5	28 - 39	66	71	12	5
<b>SKINTOP® STR M ISO silver-grey (with long metric connecting thread)</b>						
53017110	STR M 16 x 1.5	2 - 6	19	40	13	100
53017130	STR M 20 x 1.5	4 - 9	24	45	13	100
53017140	STR M 25 x 1.5	6 - 12	27	47	13	50
<b>SKINTOP® STR M ISO black (with long metric connecting thread)</b>						
53017310	STR M 16 x 1.5	2 - 6	19	40	13	100
53017330	STR M 20 x 1.5	4 - 9	24	45	13	100
53017340	STR M 25 x 1.5	6 - 12	27	47	13	50

## X-ON Electronics

Largest Supplier of Electrical and Electronic Components

*Click to view similar products for [epic manufacturer](#):*

Other Similar products are found below :

[44420040 + 73002716](#) [19426500](#) [72004000 + 73018000](#) [13.1623](#) [HBE24-FK-SE-PM-M20](#) [11161000](#) [11.1610](#) [10.4225](#) [9198+00022030](#)  
[72004000 + 73002756](#) [72000010](#) [10.5310](#) [10.4264+10.4310](#) [72040010](#) [HA4-FK-TE-SM-M-M20](#) [10.4310](#) [8883+00022030](#)  
[10.1270+10.1970+12.9545](#) [10.4220+10.4320](#) [10.4265+10.4235+10.4200+10.4210](#) [10121000+10196000+12954500](#) [10.0720](#) [44420037 +](#)  
[73002752](#) [10102000](#) [10.4264](#) [72004000 + 73002716](#) [8990+00022030](#) [44420037 + 73018000](#) [10.1210+10.1960+12.9545](#) [10.4881](#) [10431000](#)  
[10.1920](#) [10.0220+10.0030+10.1900+10.1910+12.9544](#) [44420037 + 73028500](#) [10.4861](#) [10.4265+10.4295+10.4200+10.4210](#) [13.1622](#)  
[44420037 + 73002716](#) [10.1900](#)