

## DETAILS

<b>Product Number</b>	C14116_STRADA-2X2-PX
<b>Family</b>	Strada-Module
<b>Type</b>	Lens
<b>Color</b>	clear
<b>Diameter</b>	50x50 mm
<b>Height</b>	8 mm
<b>Style</b>	square
<b>Optic Material</b>	PMMA
<b>Holder Material</b>	
<b>Fastening</b>	screw, pin
<b>Status</b>	ready
<b>ROHS Compliant</b>	Yes
<b>Date Updated</b>	23/02/2015



## OPTICAL PROPERTIES

LED	Viewing Angle	Light Beam	Efficiency	cd/lm	Connector
TL1L3	Asym deg	Asymmetric	94 %	0.760	-
XT-E	Asymmetric deg	Asymmetric	94 %	0.950	-
XM-L2	Asymmetric deg	Asymmetric	94 %	0.790	-
XM-L	Asymmetric deg	Asymmetric	94 %	0.770	-
XP-G2	Asymmetric deg	Asymmetric	94 %	1.000	-
Z5P	Asymmetric deg	Asymmetric	94 %	1.130	-
Oslon Square PC	Asymmetric deg	Asymmetric	94 %	1.100	-
Oslon SSL 150	Asymmetric deg	Asymmetric	94 %	1.300	-
XB-D	Asymmetric deg	Asymmetric	94 %	1.000	-
Oslon SSL 80	Asymmetric deg	Asymmetric	94 %	1.300	-
NCSxx19B	Asymmetric deg	Asymmetric	94 %	1.120	-
LUXEON T	Asymmetric deg	Asymmetric	94 %	0.990	-
LUXEON Rebel ES	Asymmetric deg	Asymmetric	94 %	1.050	-
XP-E	Asymmetric deg	Asymmetric	94 %	1.200	-
Z5	Asymmetric deg	Asymmetric	94 %	1.300	-
LH351A(3535)	Asymmetric deg	Asymmetric	94 %	1.200	-
H35C0 (LEMWA33)	Asymmetric deg	Asymmetric	94 %	0.900	-
H35C1 (LEMWA33)	Asymmetric deg	Asymmetric	94 %	0.980	-
NS9x383	Asymmetric deg	Asymmetric	94 %	0.750	-
NVSxx19B/NVSxx19C	Asymmetric deg	Asymmetric	94 %	0.940	-
TL1L4	Asymmetric deg	Asymmetric	91 %	1.000	-
Fortimo FastFlex LED board 2x8/740 DA 03	Asymmetric deg	Asymmetric	94 %	1.100	-
Z5M1/Z5M2	Asymmetric deg	Asymmetric	94 %	1.000	-
Z5M	Asymmetric deg	Asymmetric	94 %	1.000	-
LH351Z	Asymmetric deg	Asymmetric	94 %	1.000	-

D

C

B

A

4

4

Cent. to cent.

Rear view

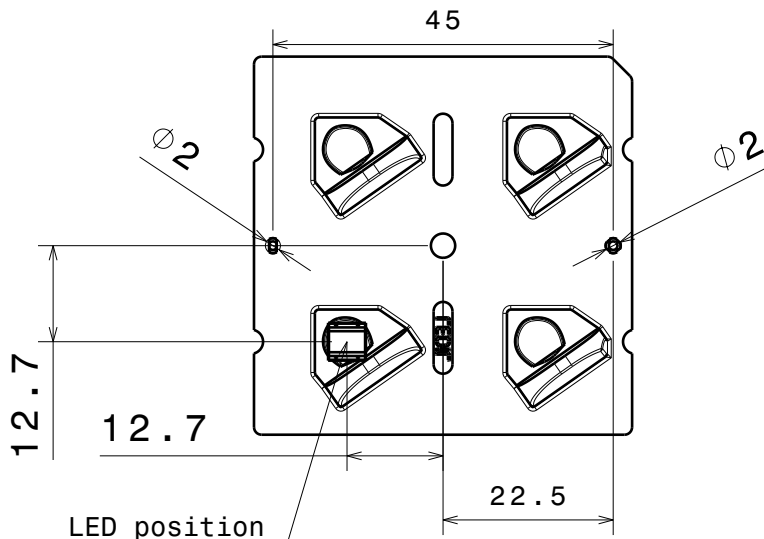

3

3

Beam asymmetric direction

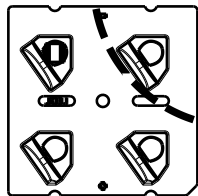

Bottom view

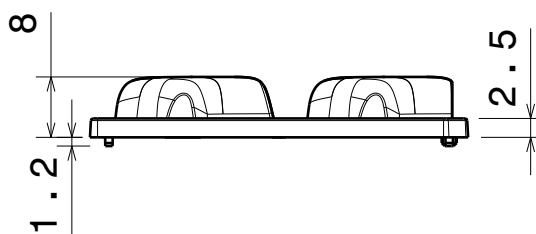

2

2

Front view

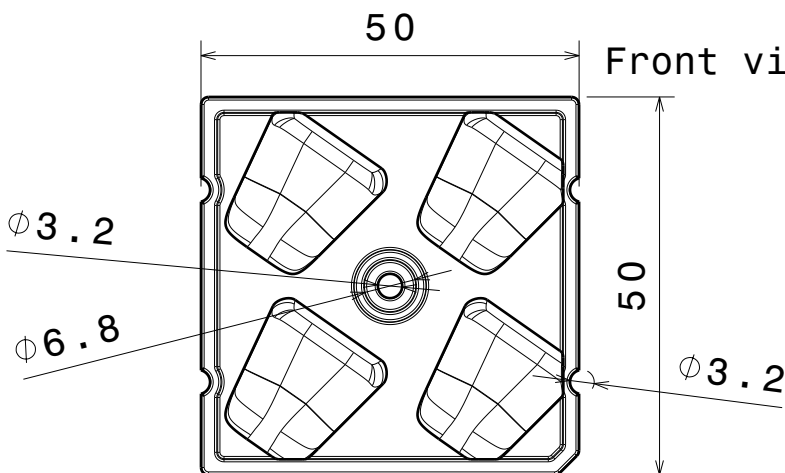

INDEX	PART NO	DESCRIPTION	MATERIAL	COLOUR
1	C14116	STRADA-2X2-PX	PMMA	clear

Tolerances if not otherwise shown  
 According to DIN ISO 2768-1  
 Linear measures:  
 Up to 30mm class M, otherwise class C.  
 According to DIN ISO 2768-2  
 Form and position: class L



Ledil Oy  
 Salorankatu 10  
 FIN 24240 SALO  
 Finland

THIRD ANGLE PROJECTION:

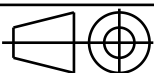

DRAWING TITLE

C14116\_STRADA-2X2-PX

This drawing is the property  
 of LEDiL Oy. It may not be  
 reproduced, copied or  
 communicated without a written  
 agreement with LEDiL Oy.

SIZE PART NUMBER

A4

C14116

SCALE 1:1 WEIGHT

SHEET 1/1

D

A

1

# Ledil C14116\_STRADA-2X2-PX\_(TL1L3) / LDC (Linear)

Luminaire: Ledil C14116\_STRADA-2X2-PX\_(TL1L3)

Lamps: 1 x Toshiba\_TL1L3\_2x2\_(TL1L3-NW1.L)\_387.773lm@250mA\_CCT=5000K\_P=2.829W\_I=0.25A

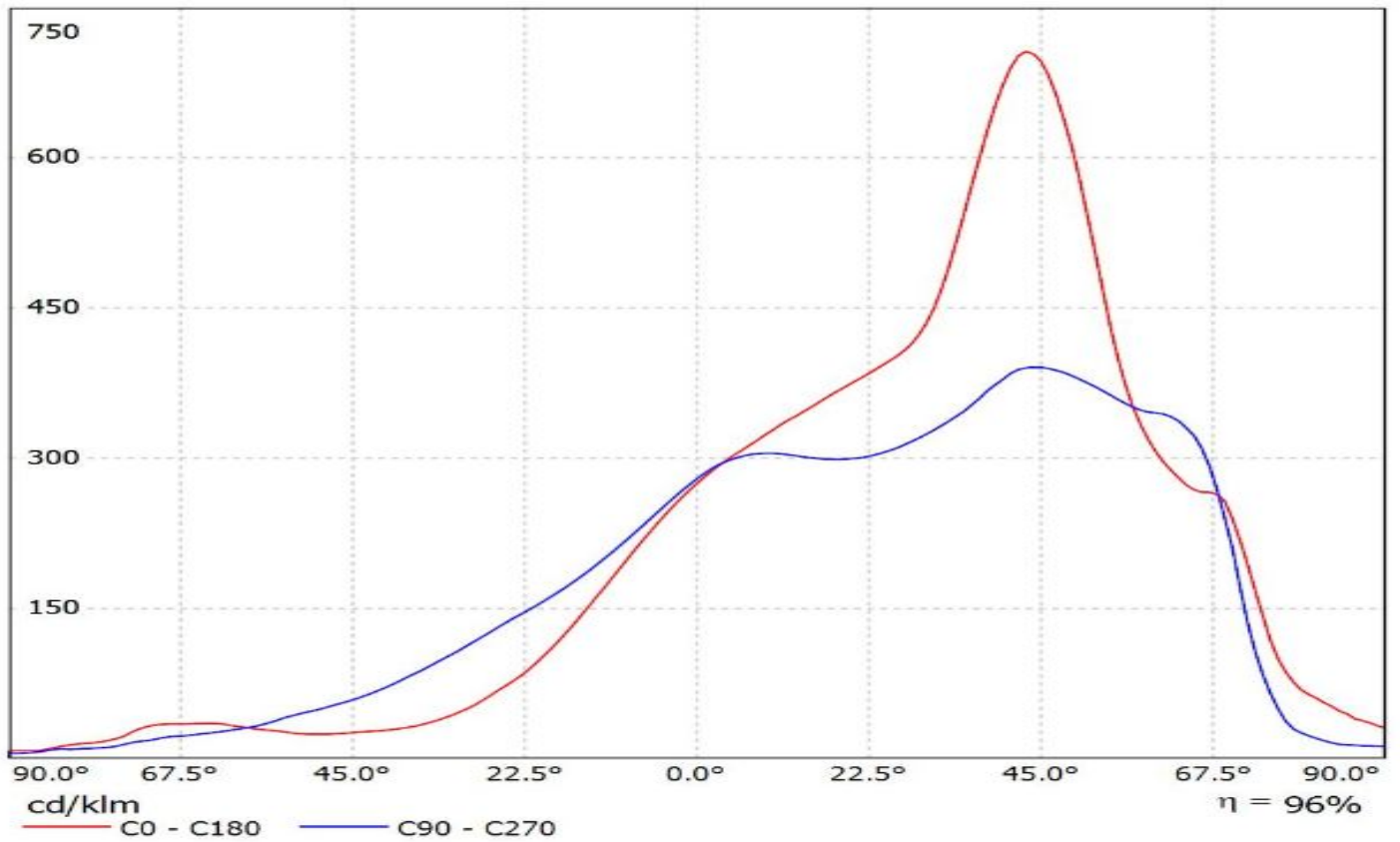

Luminaire: LEDiL Oy C14116\_STRADA-2X2-PX\_(XT-E)

Lamps: 1 x CREE\_XT-E\_2x2\_390.75lm@250mA\_CCT=5717K\_P=2.99855W\_I=249.9mA

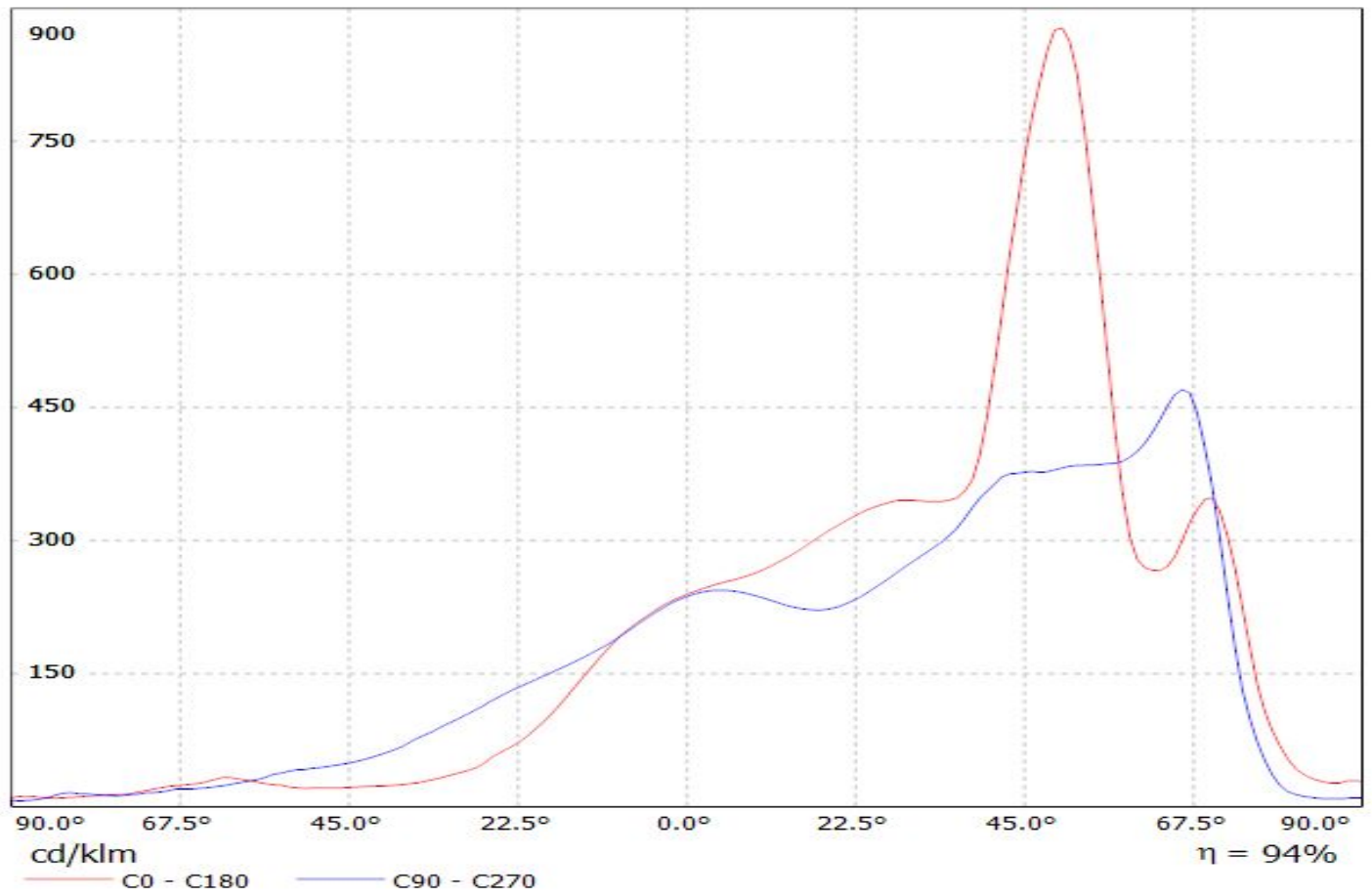

Luminaire: LEDiL Oy C14116\_STRADA-2X2-PX\_(XM-L2)  
Lamps: 1 x CREE\_XM-L2\_2x2\_(XMLBWT-0-7B4-T30-0L-001)  
\_361.65lm@250mA\_CCT3220K\_P=2.81924W\_I=249.8mA

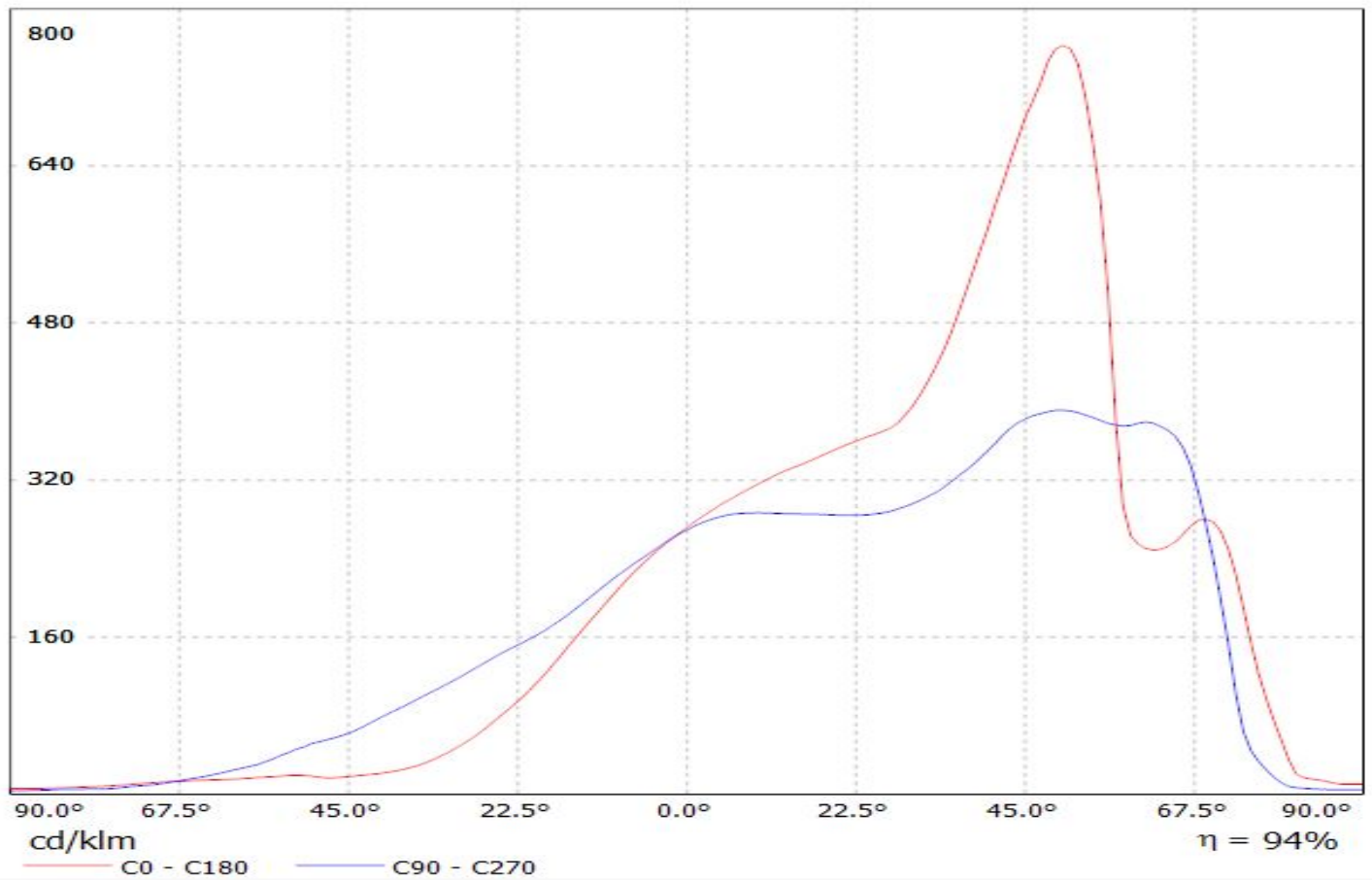

Luminaire: LEDiL Oy C14116\_STRADA-2X2-PX\_(XM-L)

Lamps: 1 x CREE\_XM-L\_2x2\_362.5lm@250mA\_CCT7700K\_P=2.83911W\_I=249.9mA

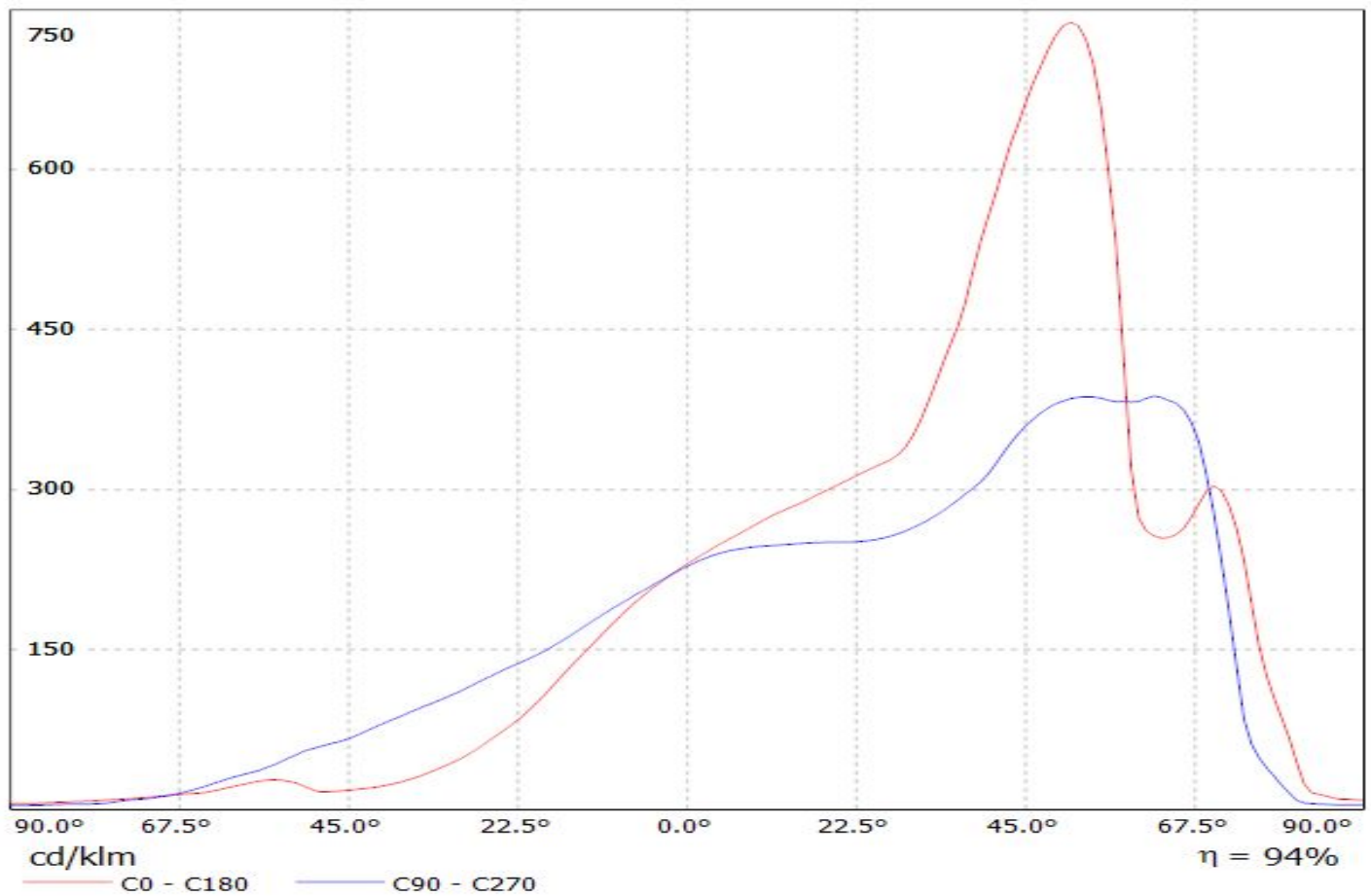

Luminaire: LEDiL Oy C14116\_STRADA-2X2-PX\_(XP-G2)  
Lamps: 1 x CREE\_XP-G2\_2x2\_(XPGBWT-L1-000-00G51)  
\_414.85lm@250mA\_CCT=7181K\_P=2.95563W\_I=249.8mA

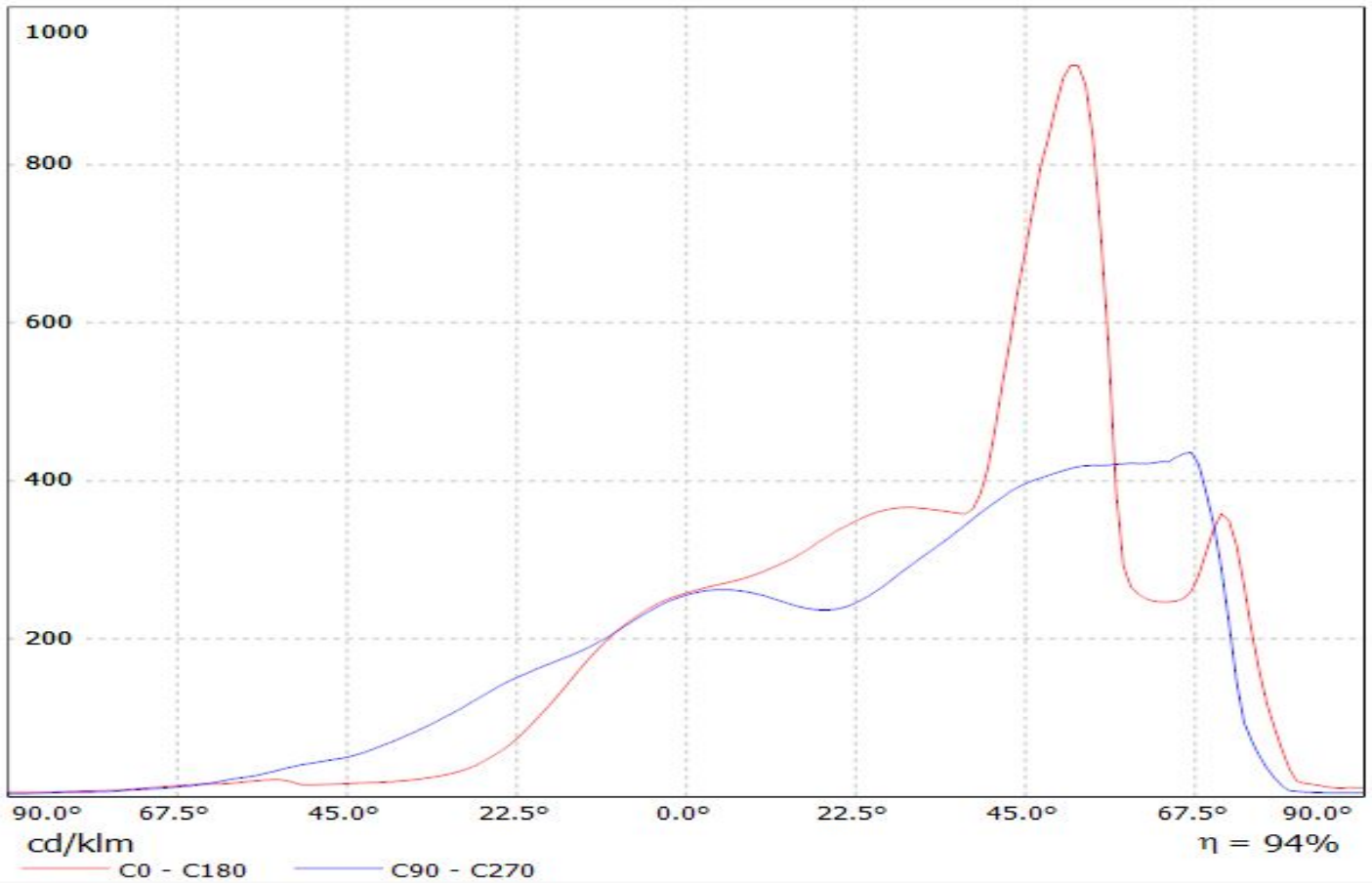

Luminaire: LEDiL Oy C14116\_STRADA-2x2-PX\_(Z5P)

Lamps: 1 x SEOUL\_Z5P\_2x2\_286.1lm@250mA\_P=3.66253W\_I=249.9mA

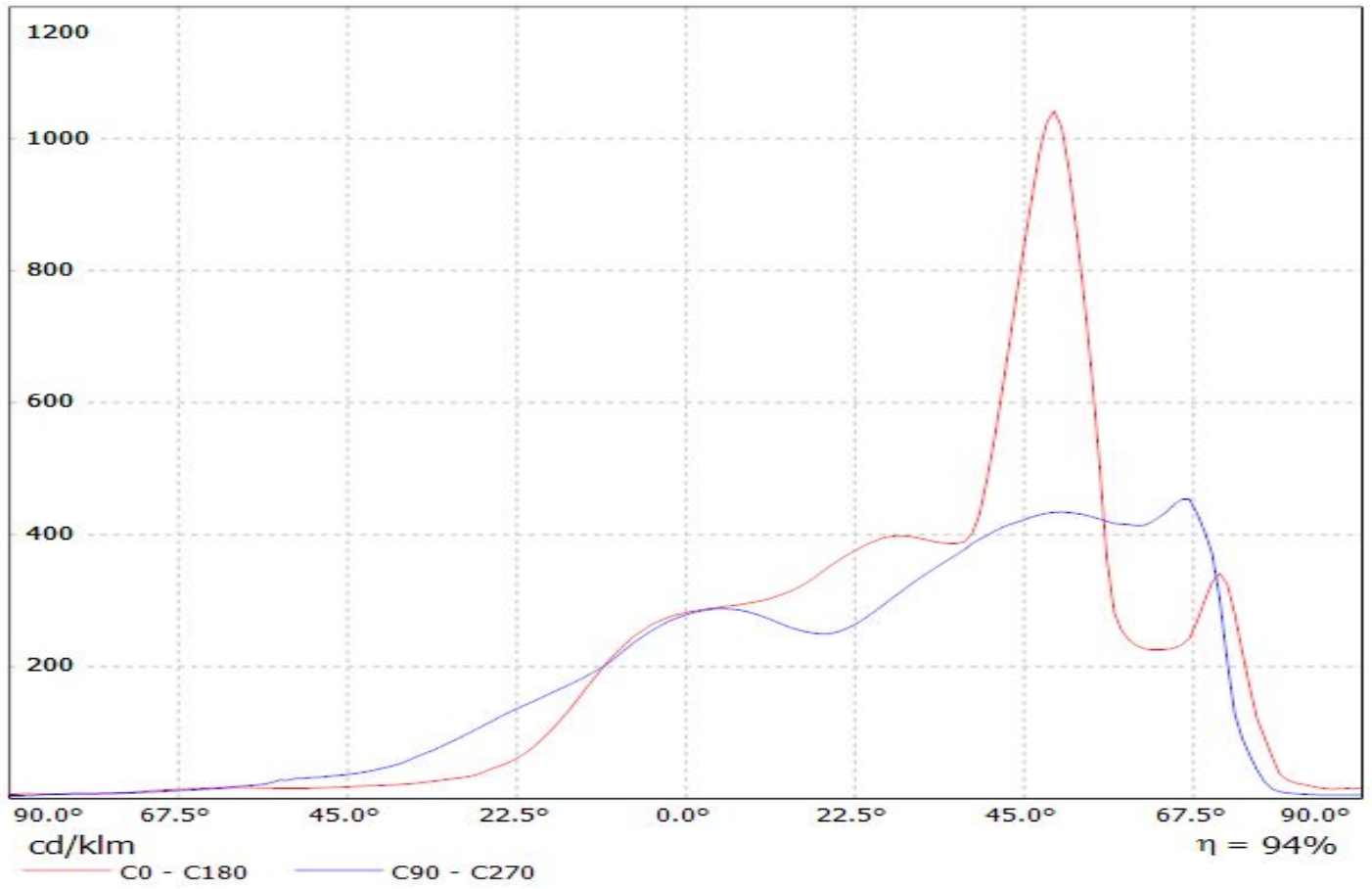



Luminaire: LEDiL Oy C14116\_STRADA-2X2-PX\_(SQ-PC)  
Lamps: 1 x OSRAM\_OSLON\_SQUARE\_PC\_2x2\_(LCW\_CQAR.PC-MSMU-5H71-1)  
\_423.6lm@250mA\_CCT=5960K\_P=2.86246W\_I=249.8mA

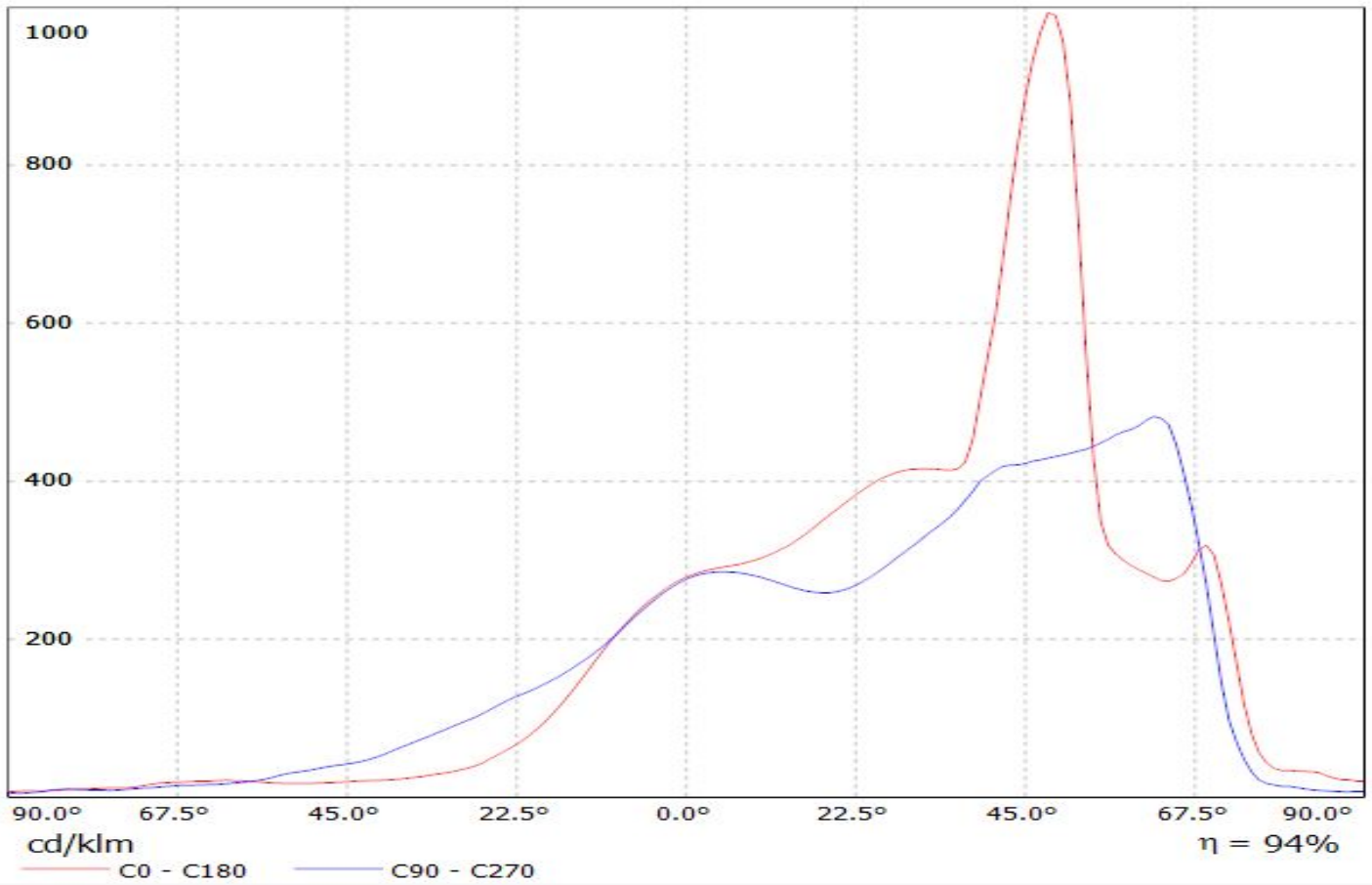

Luminaire: LEDiL Oy C14116\_STRADA-2X2-PX\_(SSL150)

Lamps: 1 x OSOLON SSL150\_2x2\_284.9lm@250mA\_CCT=3154K\_P=3.15274W\_I=249.9mA

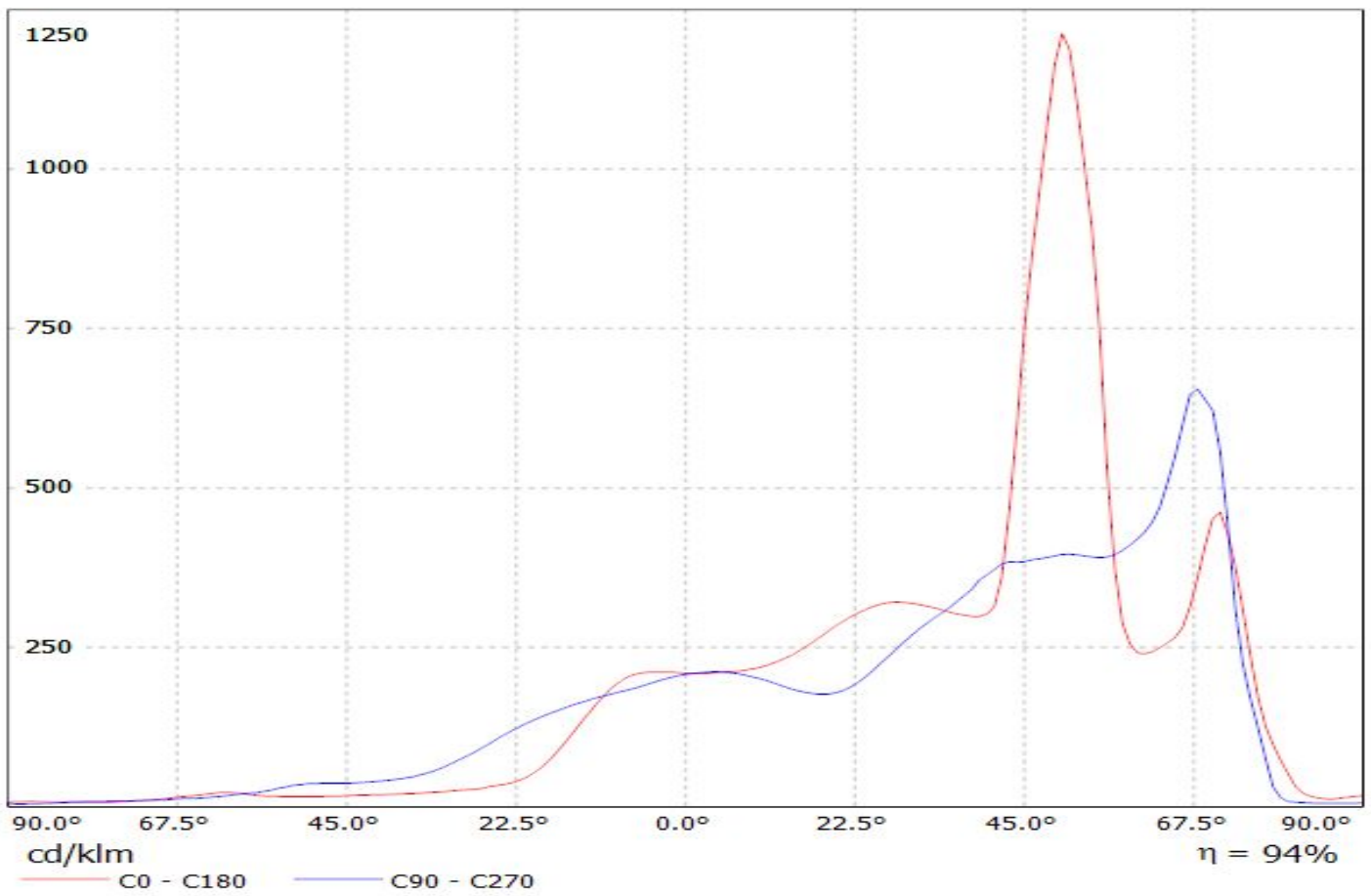

Luminaire: LEDiL Oy C14116\_STRADA-2X2-PX\_(XB-D)

Lamps: 1 x CREE\_XB-D\_2x2\_366.34lm@250mA\_P=3.07877W\_I=249.9mA

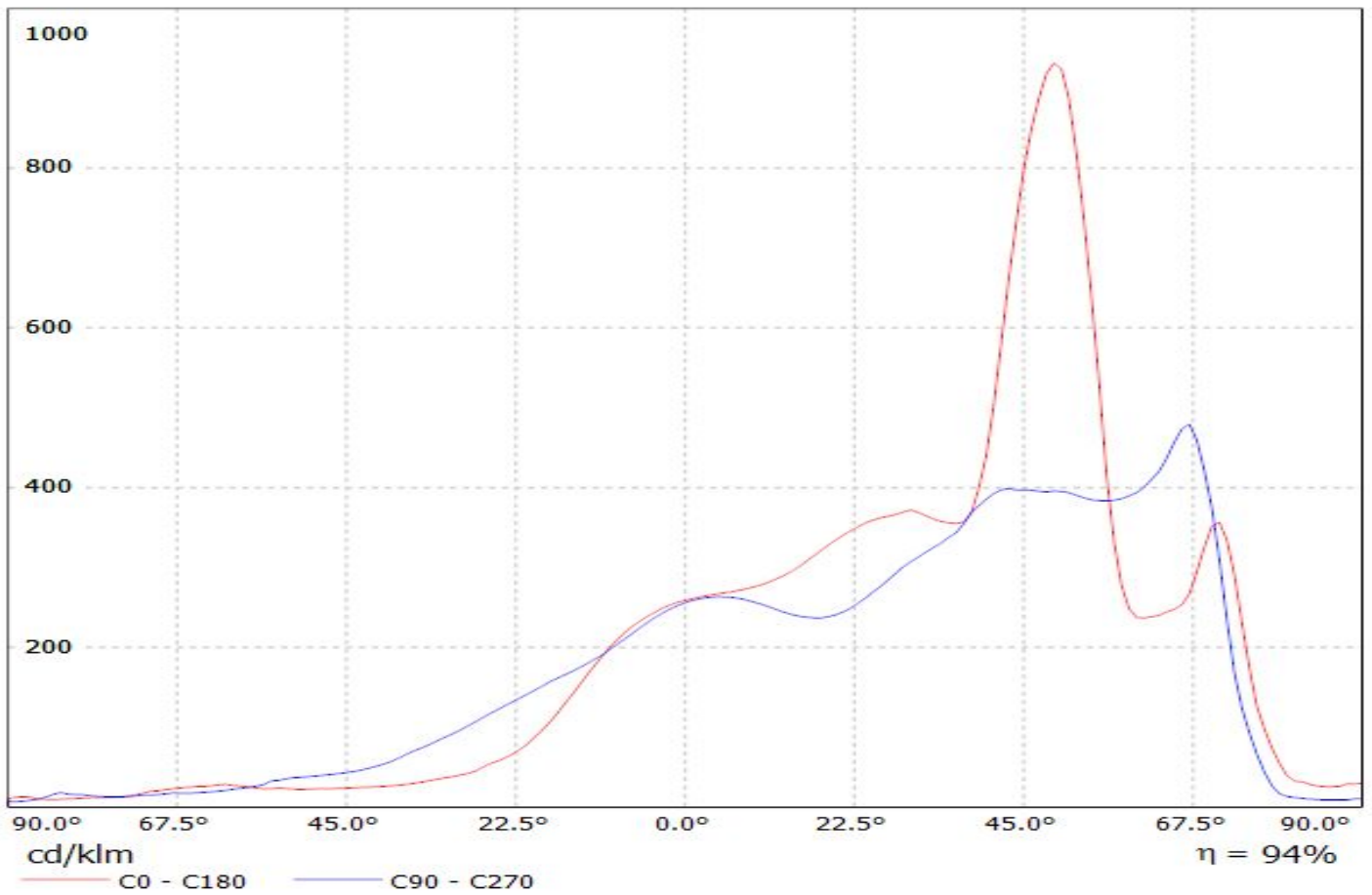

Luminaire: LEDiL Oy C14116\_STRADA-2X2-PX\_(SSL80)

Lamps: 1 x OSLO<sub>N</sub>\_SSL80\_2x2\_314.4lm@250mA\_CCT=6775K\_P=3.16548W\_I=249.9mA

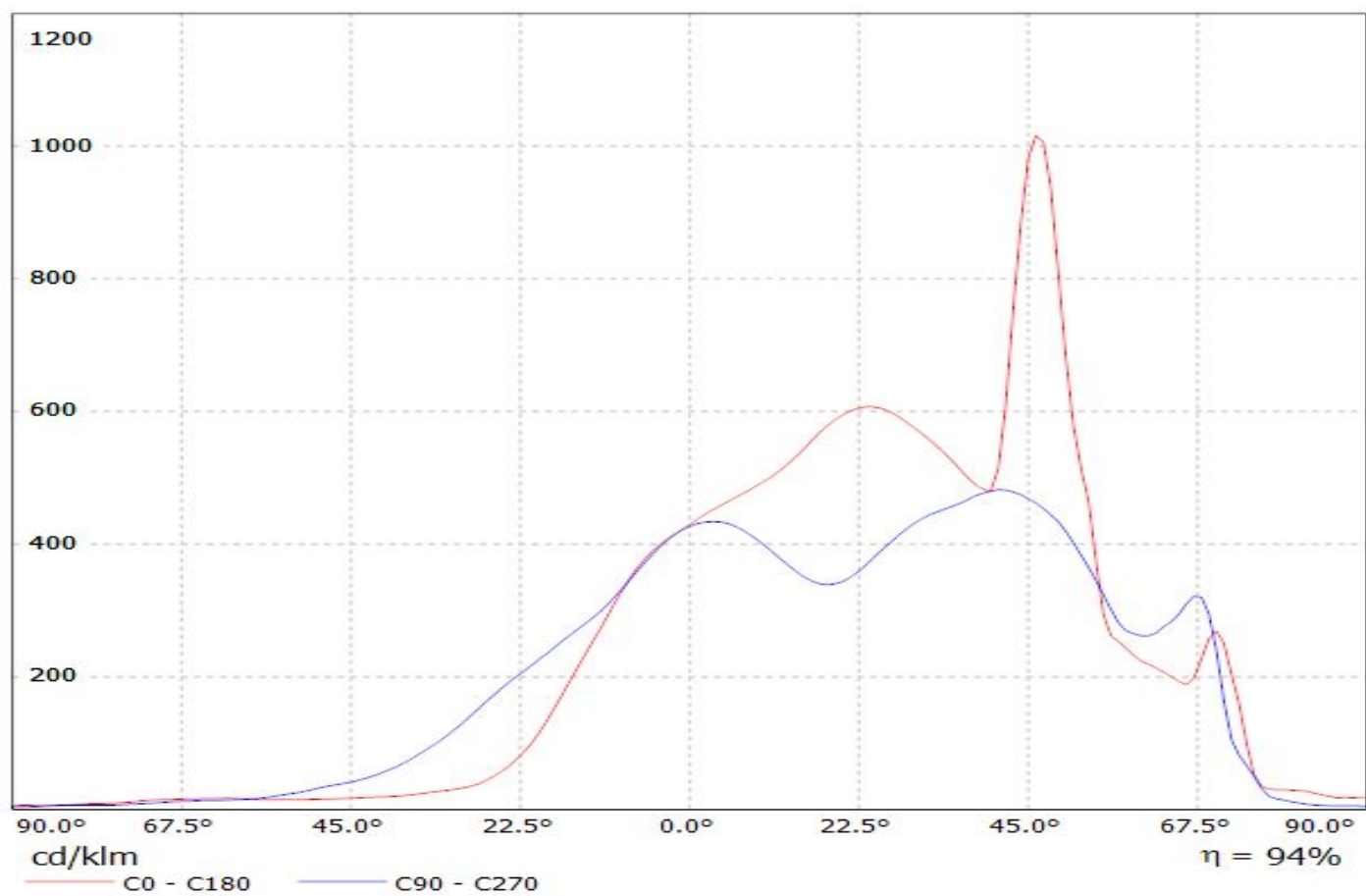

Luminaire: LEDiL Oy C14116\_STRADA-2X2-PX\_(NCSxx19B)  
Lamps: 1 x NICHIA\_NCSxx19B\_(NCSW119BE)  
\_2x2\_439.5lm@250mA\_CCT=5403K\_P=3.0083W\_I=249.9mA

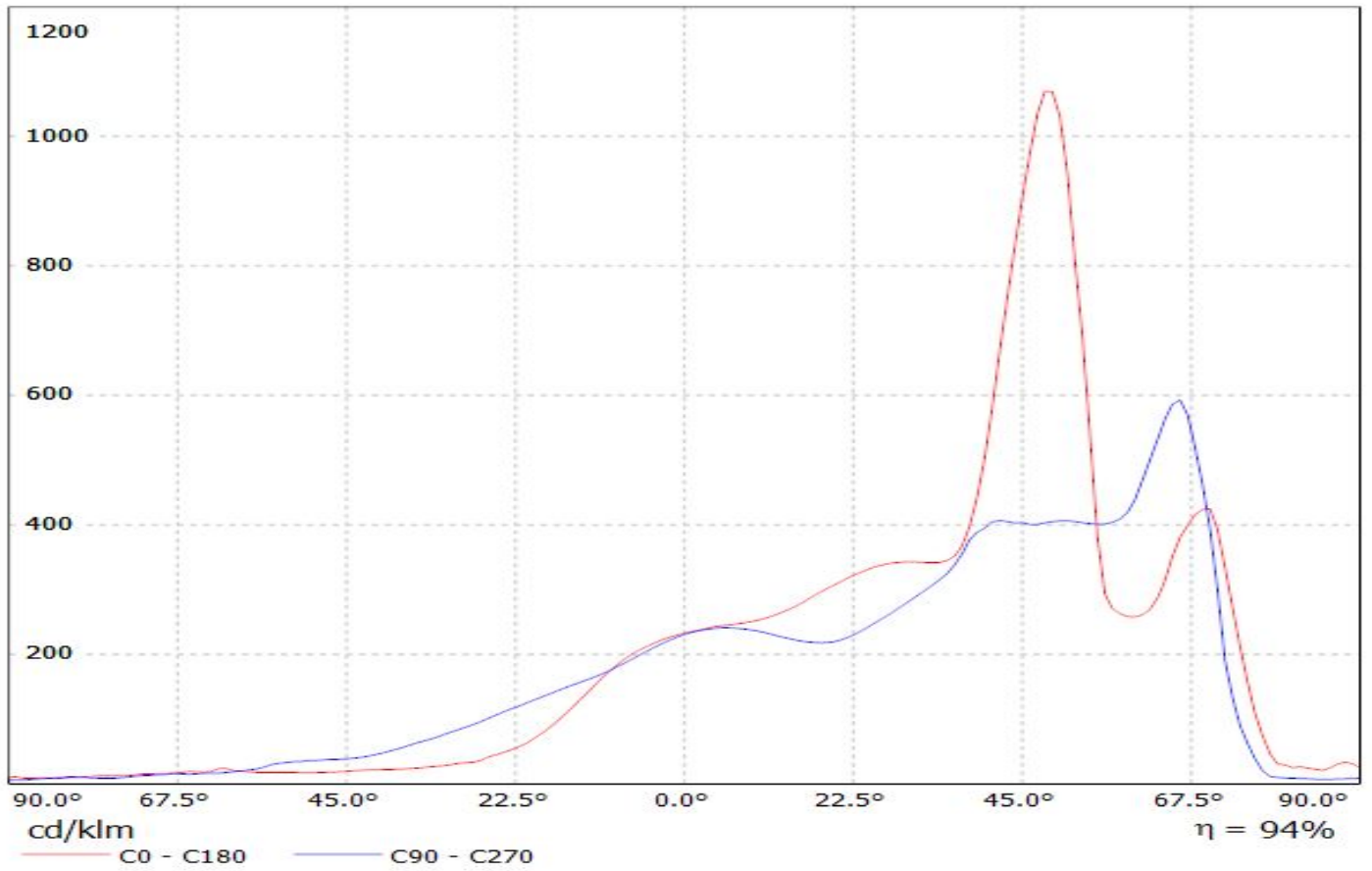

Luminaire: LEDiL Oy C14116\_STRADA-2X2-PX (LUXEON\_T)  
Lamps: 1 x LUXEON\_T\_2x2\_(LXH8-FW30-3)\_294.67lm@250mA\_P=2.806W\_I=249.8mA

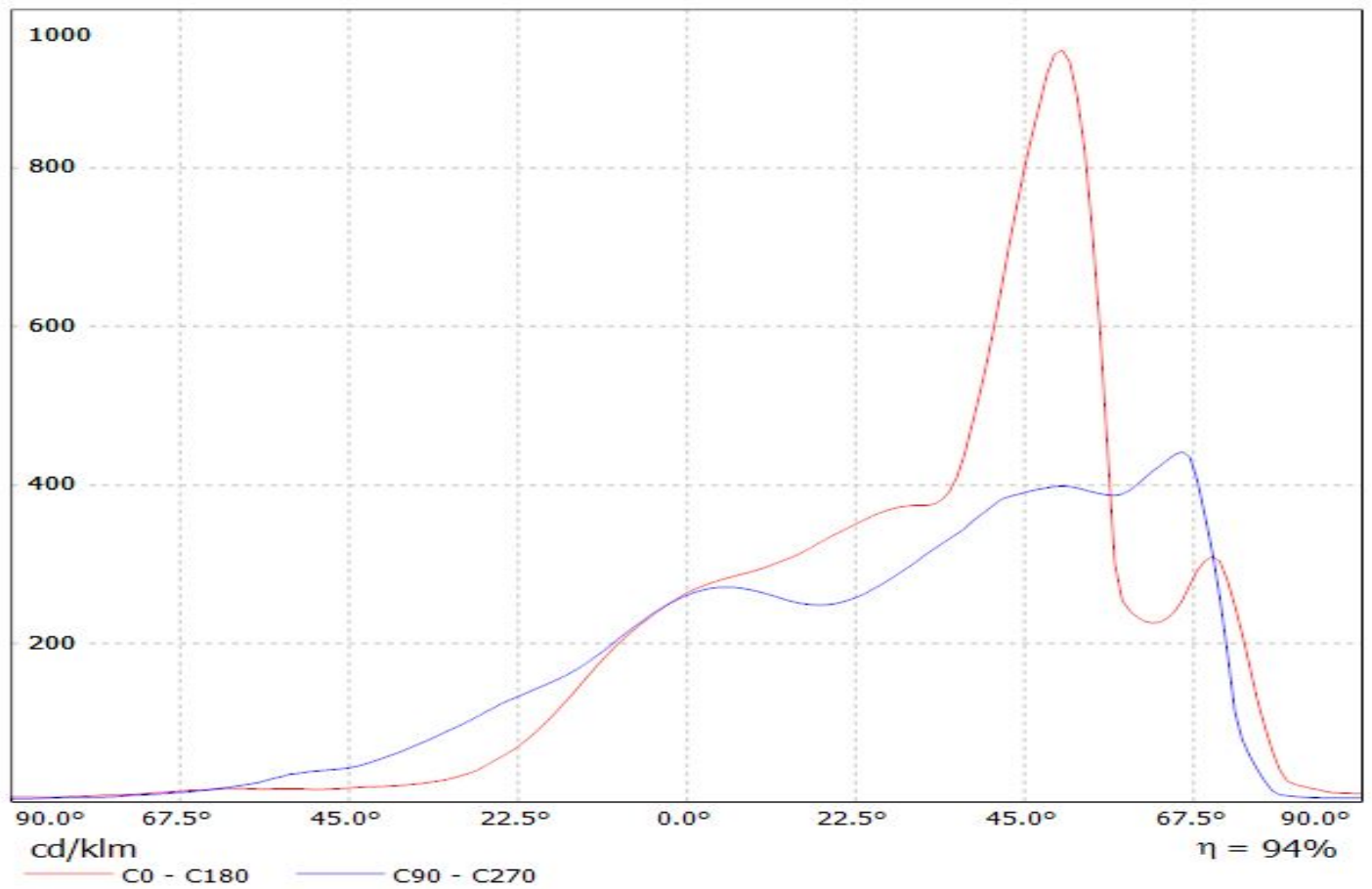

Luminaire: LEDiL Oy C14116\_STRADA-2X2-PX\_(REBEL\_ES)

Lamps: 1 x LUXEON\_REBEL\_ES\_2x2\_340.26lm@250mA\_P=2.87295W\_I=249.8mA

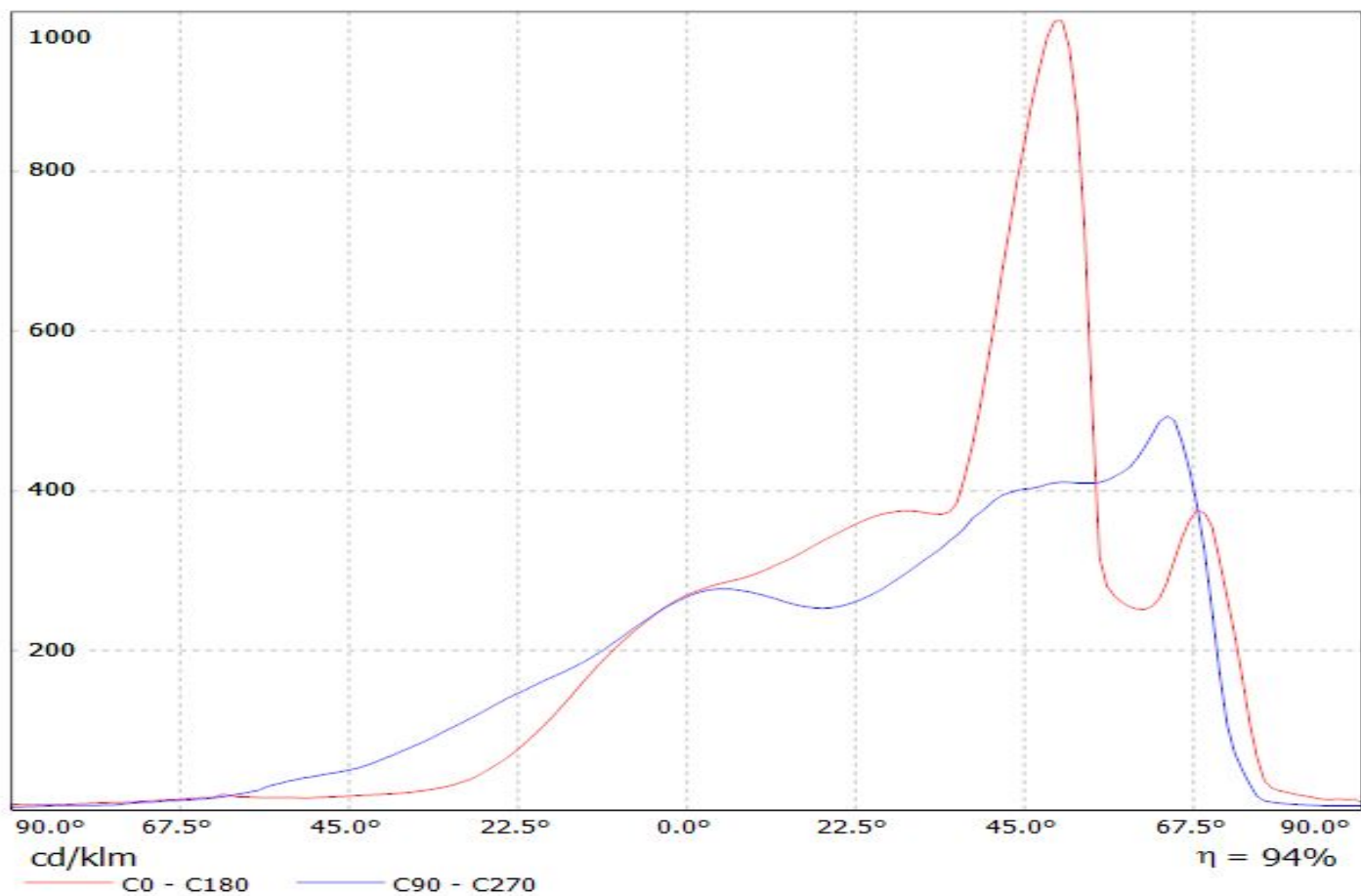

Luminaire: LEDiL Oy C14116\_STRADA-2X2-PX\_(XP-E)  
Lamps: 1 x Cree\_XP-E\_2x2\_(XPEWHT-L1-3C0-Q5-0-06)  
\_305.07lm@250mA\_CCT=5434K\_P=3.06902W\_I=249.9mA

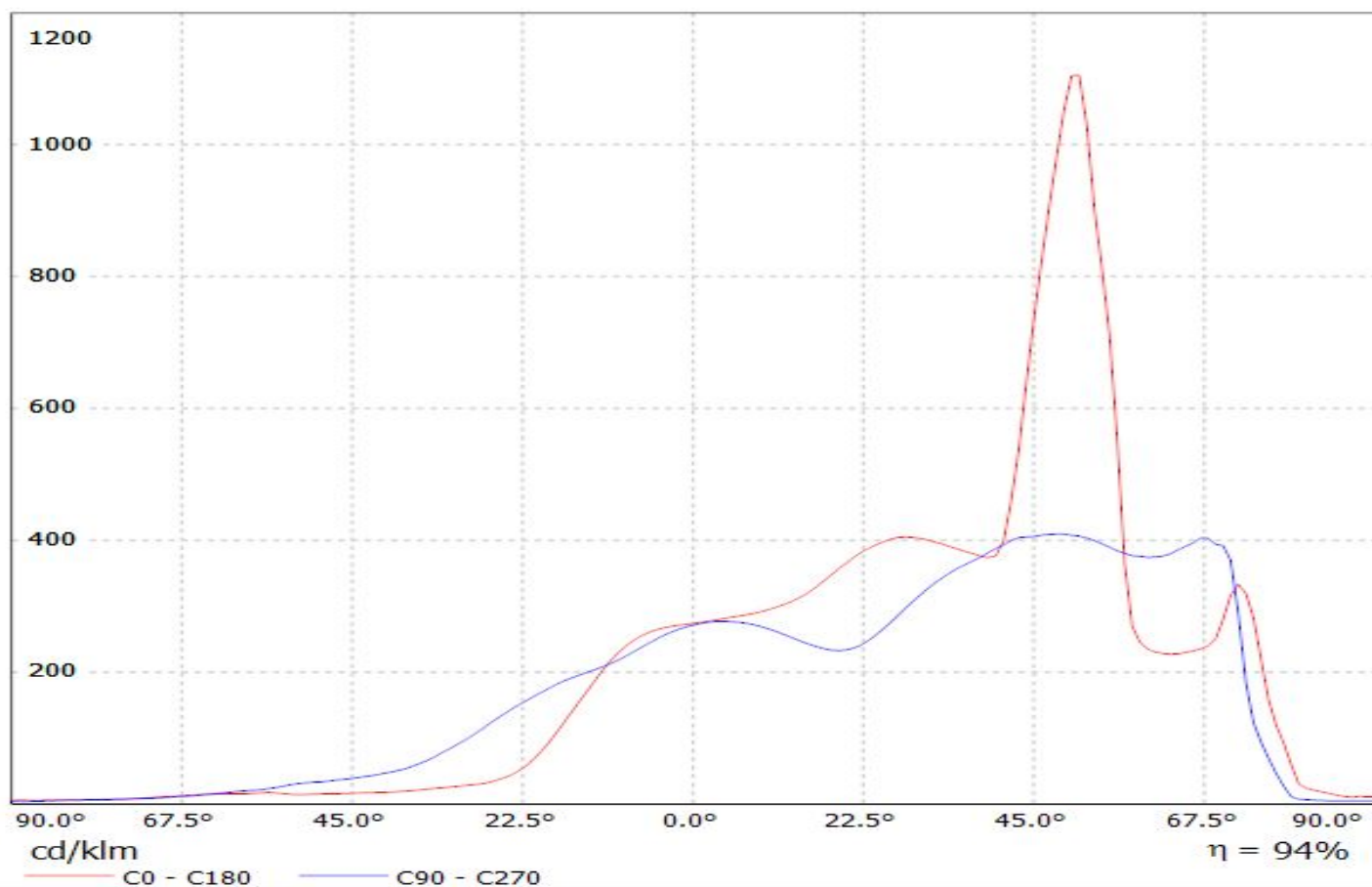



Luminaire: LEDiL Oy C14116\_STRADA-2X2-PX\_(Z5)

Lamps: 1 x SEOUL\_Z5\_(SZW05A0B)\_339.3lm@250mA\_P=3.01134W\_I=249.8mA

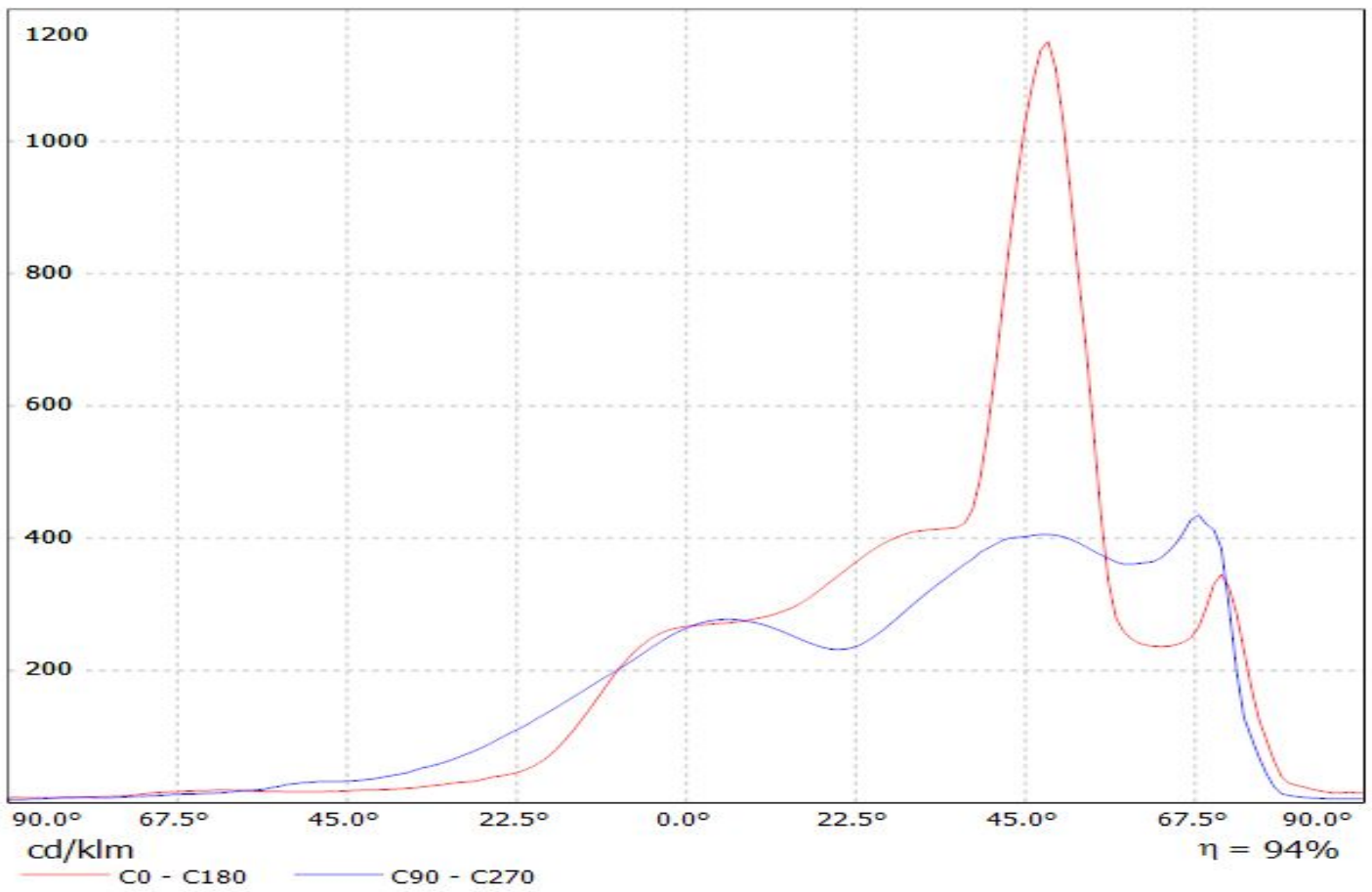

Luminaire: LEDiL Oy C14116\_STRADA-2X2-PX\_(LH351A)

Lamps: 1 x Samsung\_LH351A\_2x2\_339.2lm@250mA\_P=3.20997W\_I=249.9mA

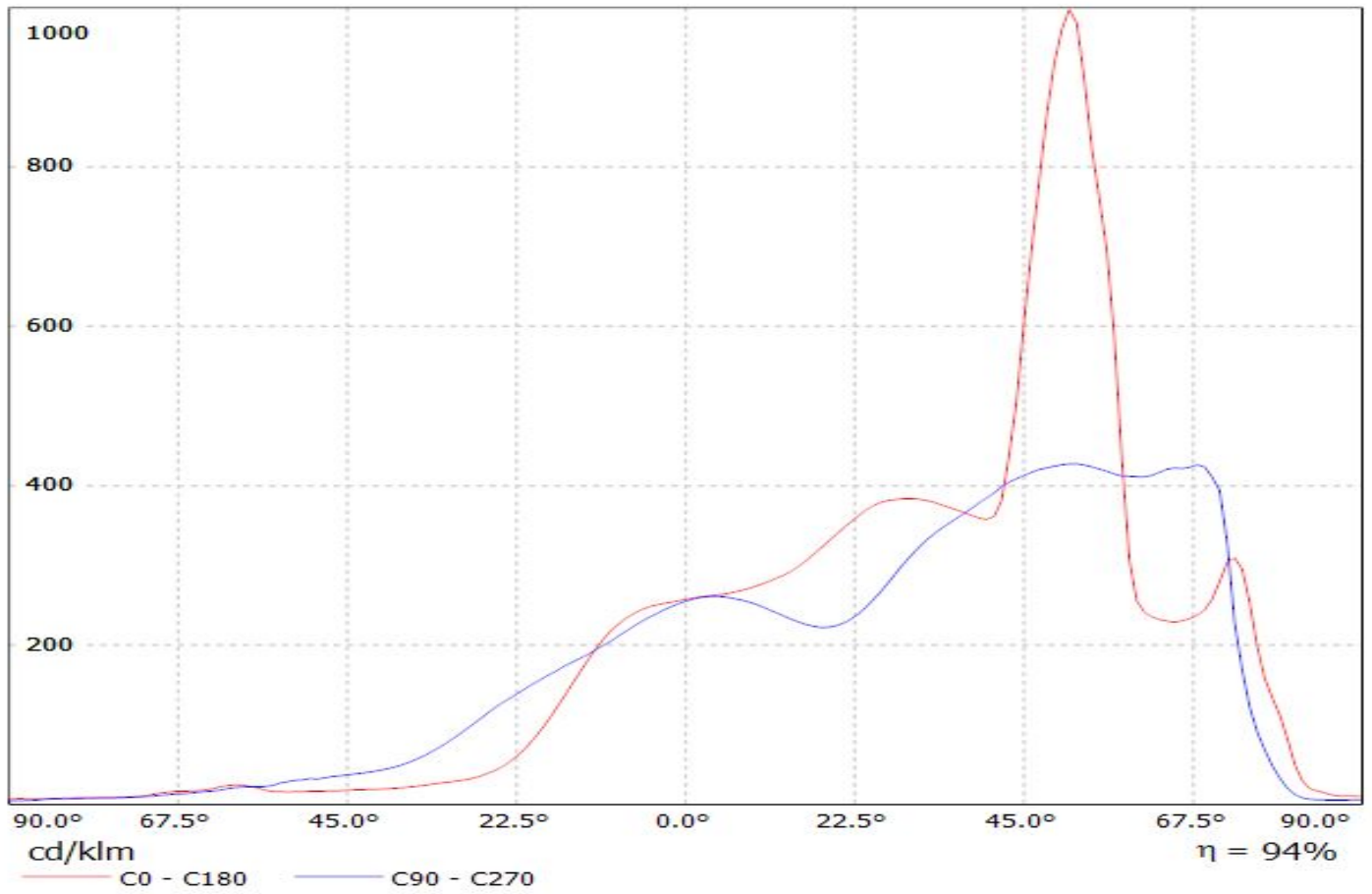

Luminaire: LEDiL Oy C14116\_STRADA-2X2-PX\_(H35C0)  
Lamps: 1 x LG\_H35C0\_2x2\_371.8lm@250mA\_P=2.94332W\_I=249.9mA

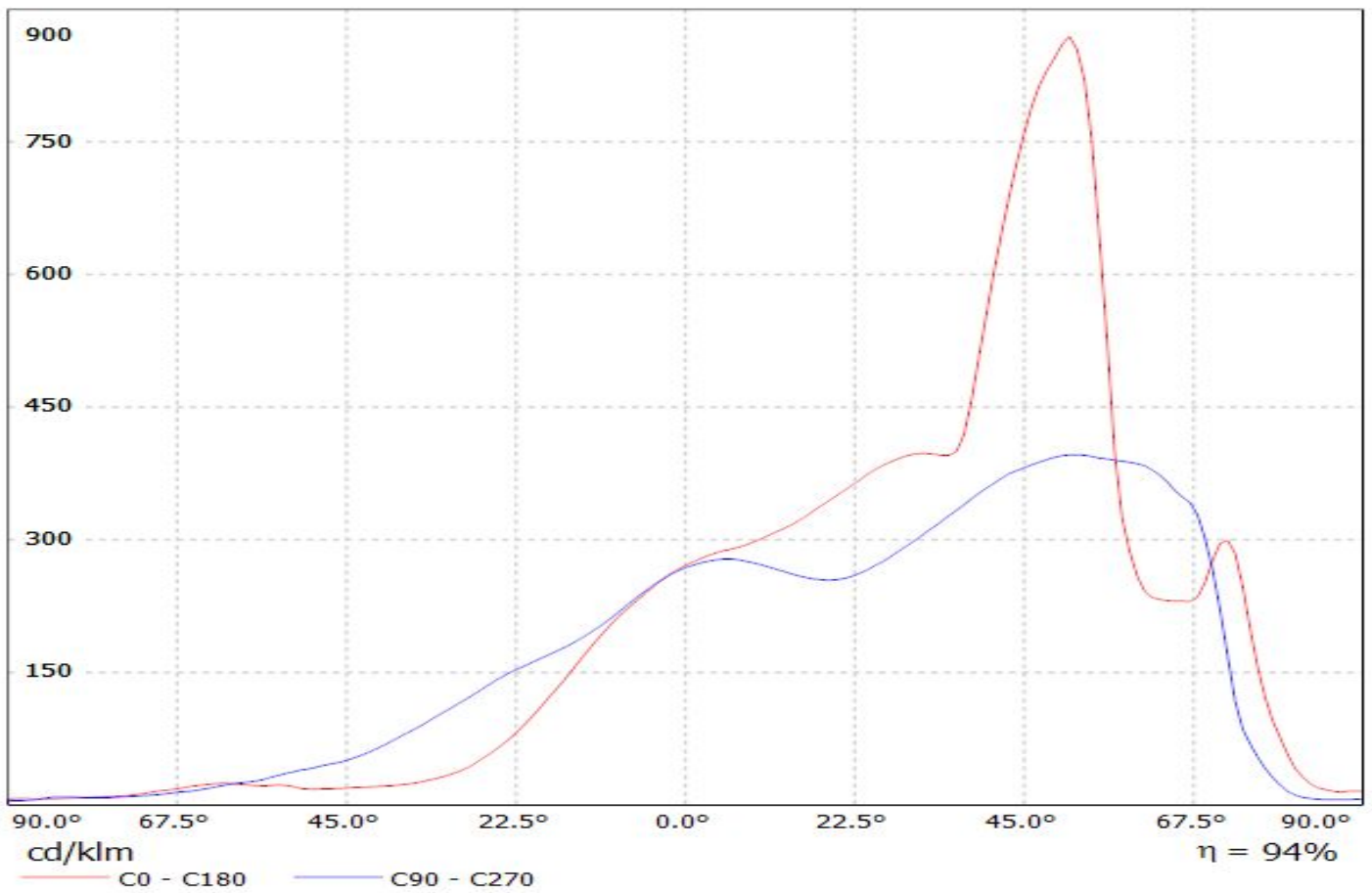

Luminaire: LEDiL Oy C14116\_STRADA-2X2-PX\_(H35C1)

Lamps: 1 x LG\_H35C1\_2x2\_469.35lm@250mA\_P=2.86535W\_I=249.9mA

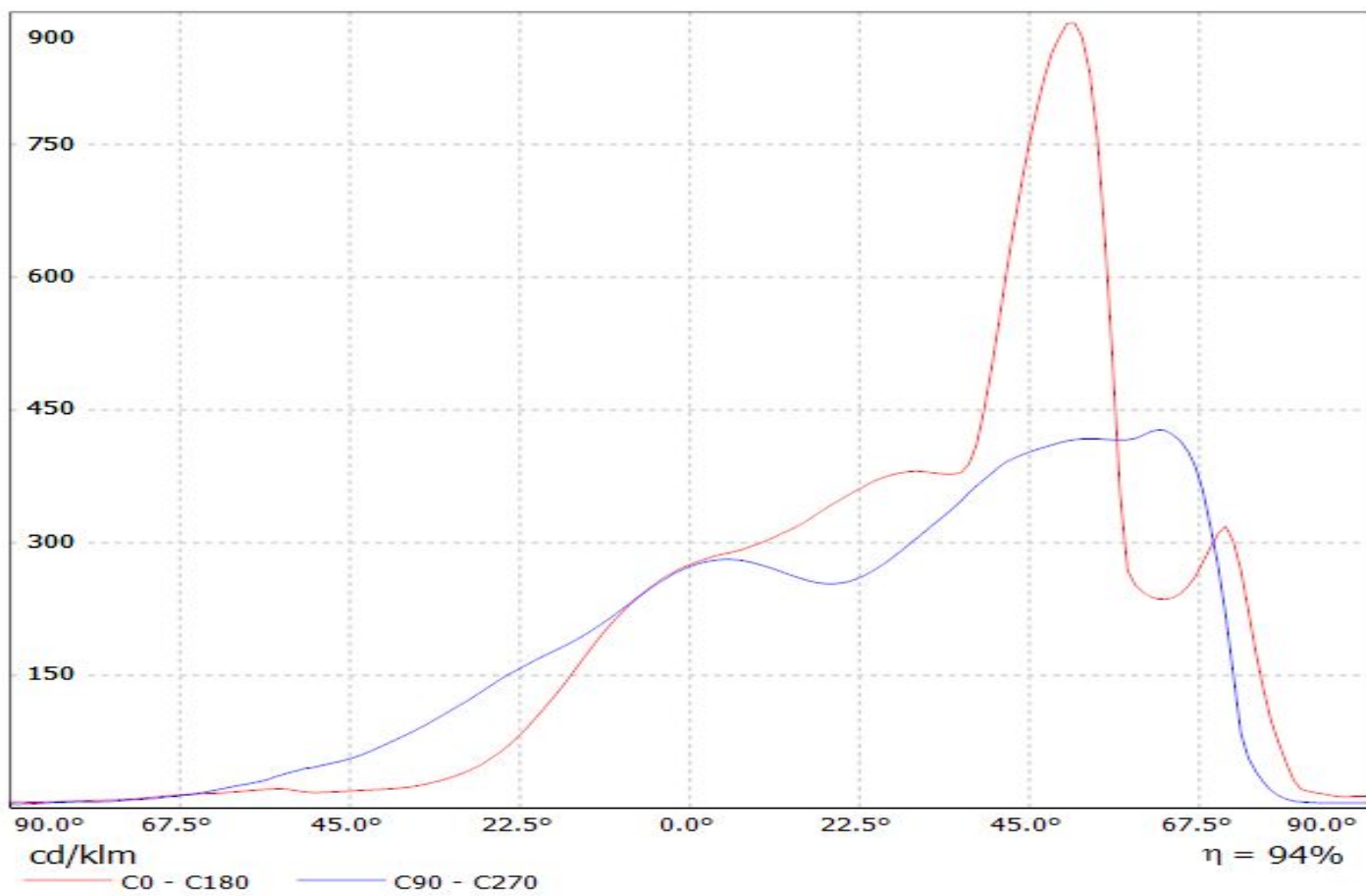

Luminaire: LEDiL Oy C14116\_STRADA-2X2-PX\_(NS9x383)

Lamps: 1 x NICHIA\_NS9x383\_(NS9W383T)\_2x2\_380.85lm@250mA\_P=2.8856W\_I=249.9mA

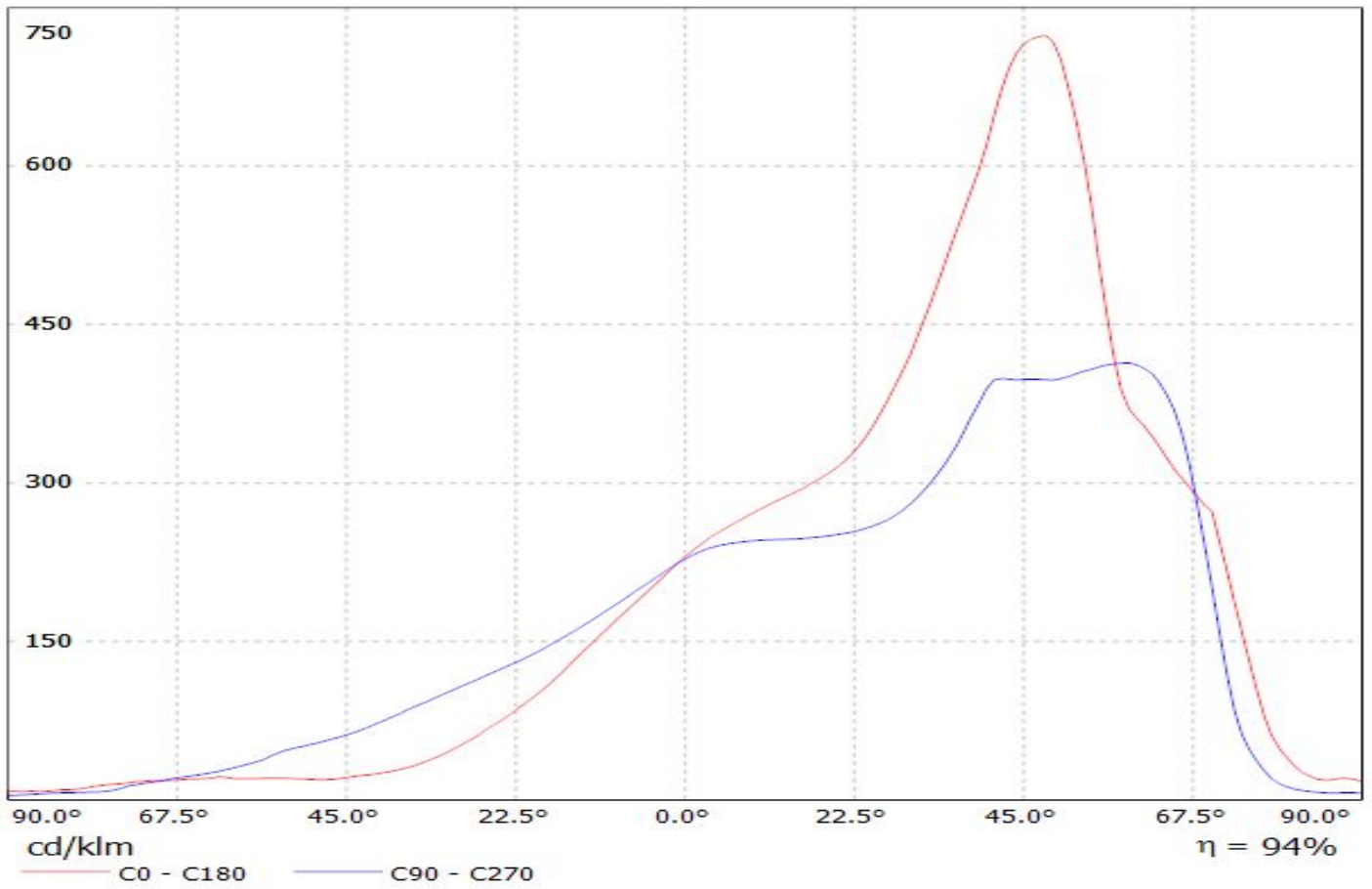

Luminaire: LEDiL Oy C14116\_STRADA-2X2-PX\_(NVSxx19B)  
Lamps: 1 x NICHIA\_NV5xx19B\_(NV5219BE)  
\_2x2\_315lm@250mA\_CCT=3071K\_U=2.88235W\_I=249.9mA

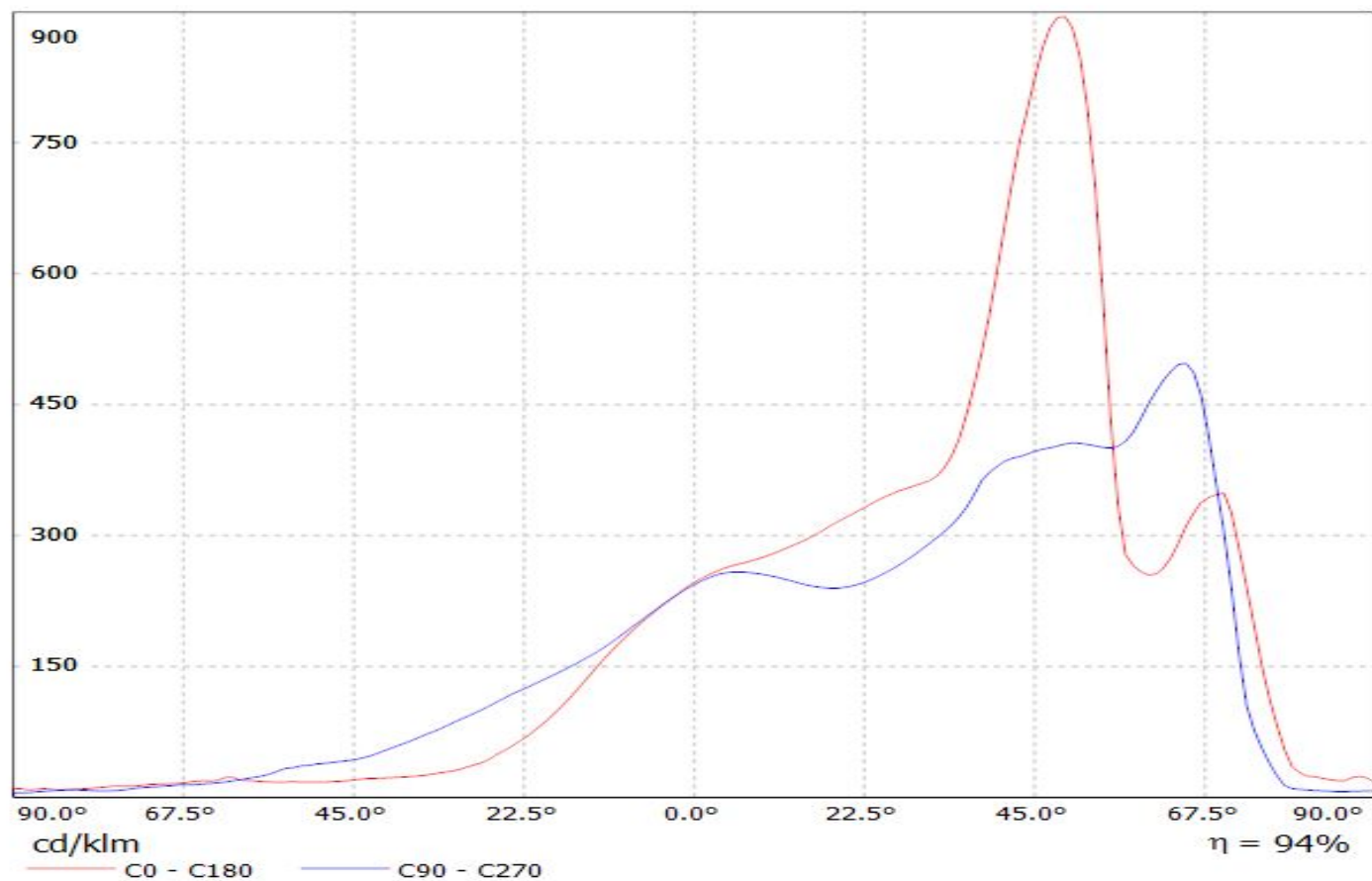

# Ledil C14116\_STRADA-2X2-PX\_(TL1L4) / LDC (Linear)

Luminaire: Ledil C14116\_STRADA-2X2-PX\_(TL1L4)

Lamps: 1 x Toshiba\_TL1L4\_2x2\_(TL1L4-DW0)\_472.639lm@250mA\_CCT=6500K\_P=2.9W\_I=0.25A

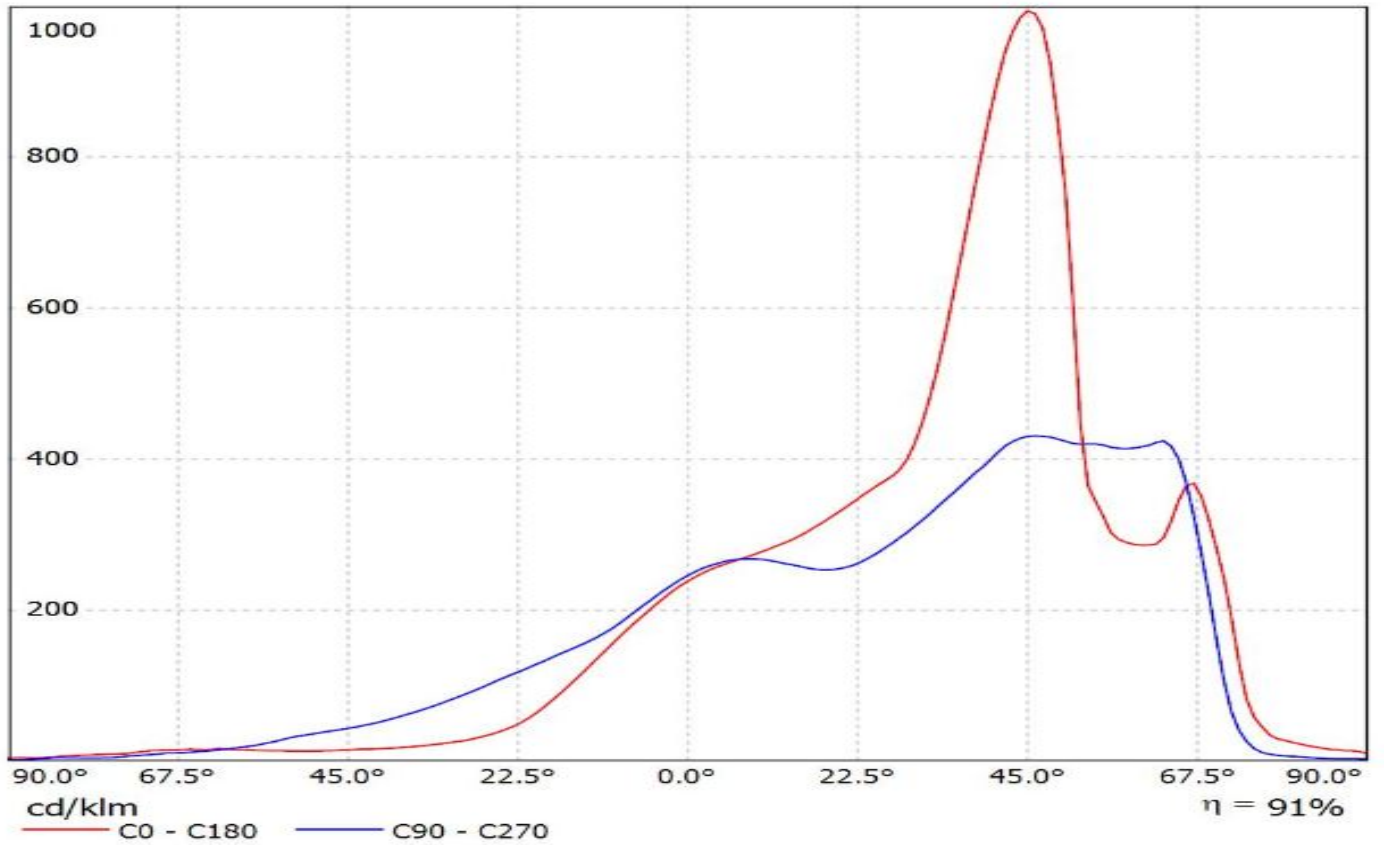

Luminaire: LEDiL Oy C14116\_STRADA-2X2-PX\_(Fortimo\_F-Flex\_2x8\_740DAG3)  
Lamps: 1 x Philips\_Fortimo\_F-Flex\_2x8\_740DAG3\_1780.2lm@250mA\_P=11.6112W\_I=0.2498A

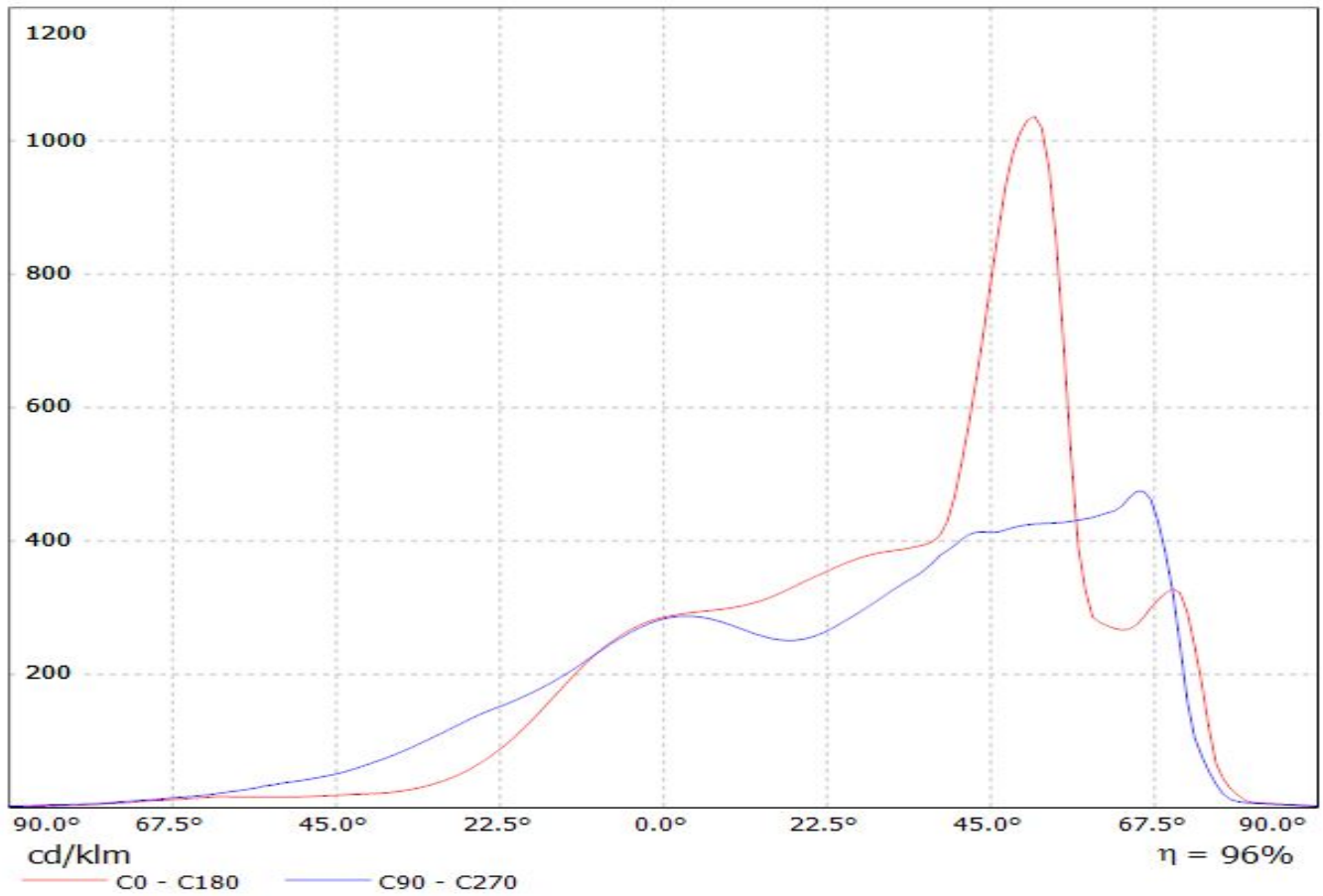



Luminaire: LEDiL Oy C14116\_STRADA-2x2-PX\_(Z5M1)  
Lamps: 1 x SEOUL\_Z5M1\_2x2\_(SZ5-M1-WN-C8)  
\_391.15lm@250mA\_CCT=4587K\_P=2.86086W\_I=249.9mA

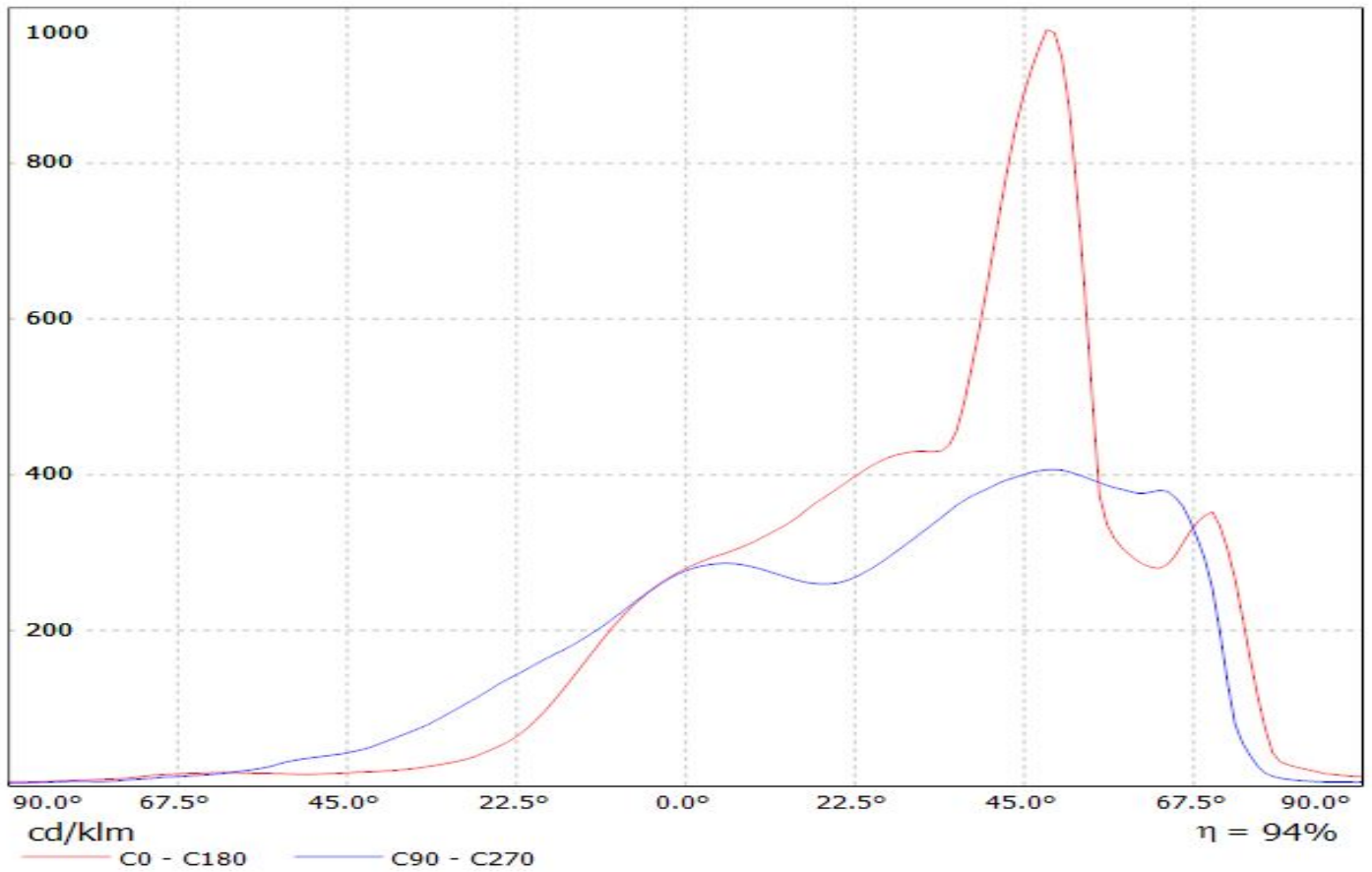

Luminaire: LEDiL Oy C14116\_STRADA-2x2-PX\_(Z5M)

Lamps: 1 x SEOUL\_Z5M\_2x2\_(SZ5-M0-W0-00)\_366.55lm@250mA\_P=2.96931W\_I=249.9mA

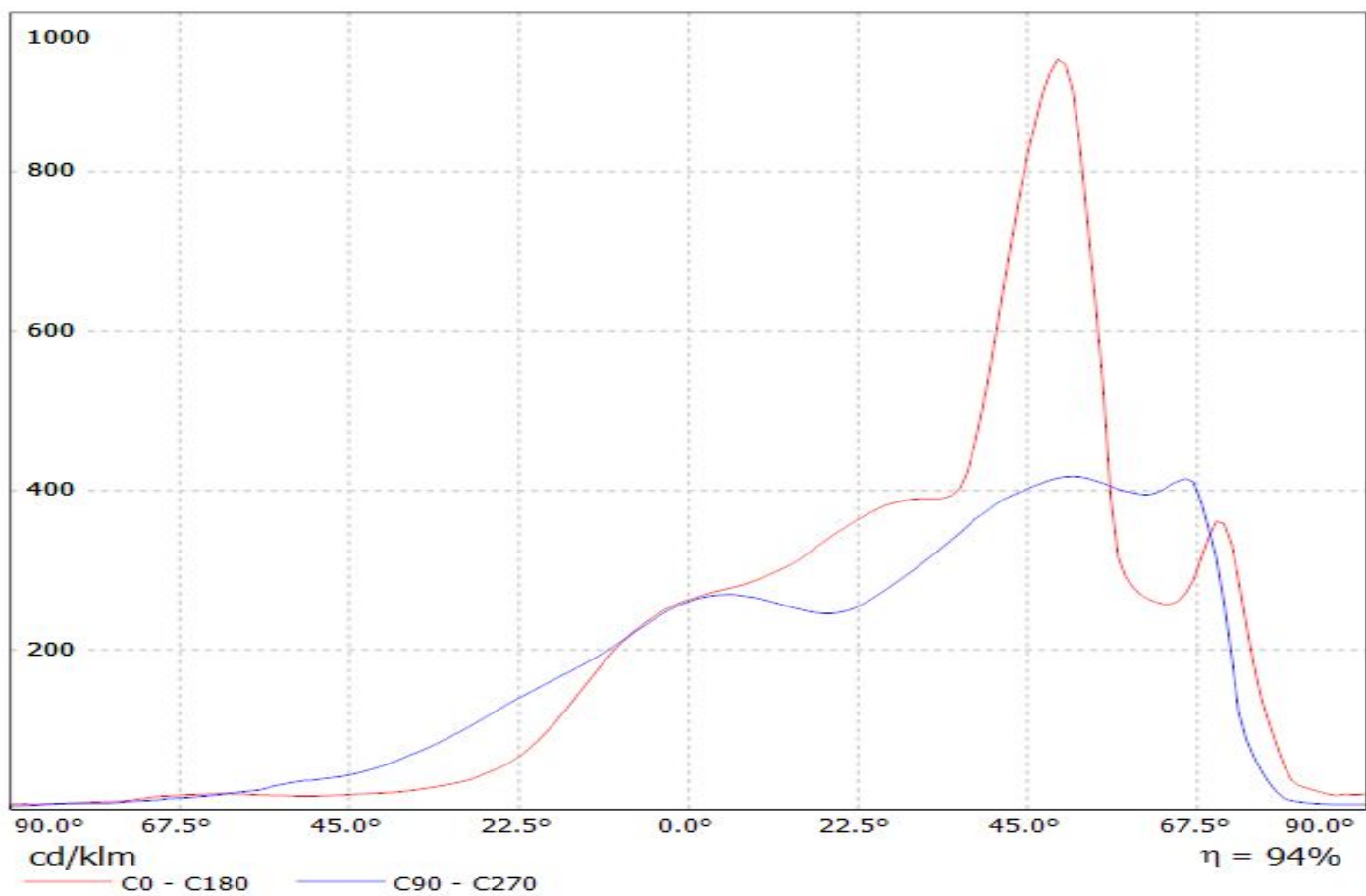

Luminaire: LEDiL Oy C14116\_STRADA-2x2-PX\_(LH351Z)

Lamps: 1 x SAMSUNG\_LH351Z\_2x2\_(SZ5-M0-W0-00)\_363.65lm@250mA\_P=2.86635W\_I=249.9mA

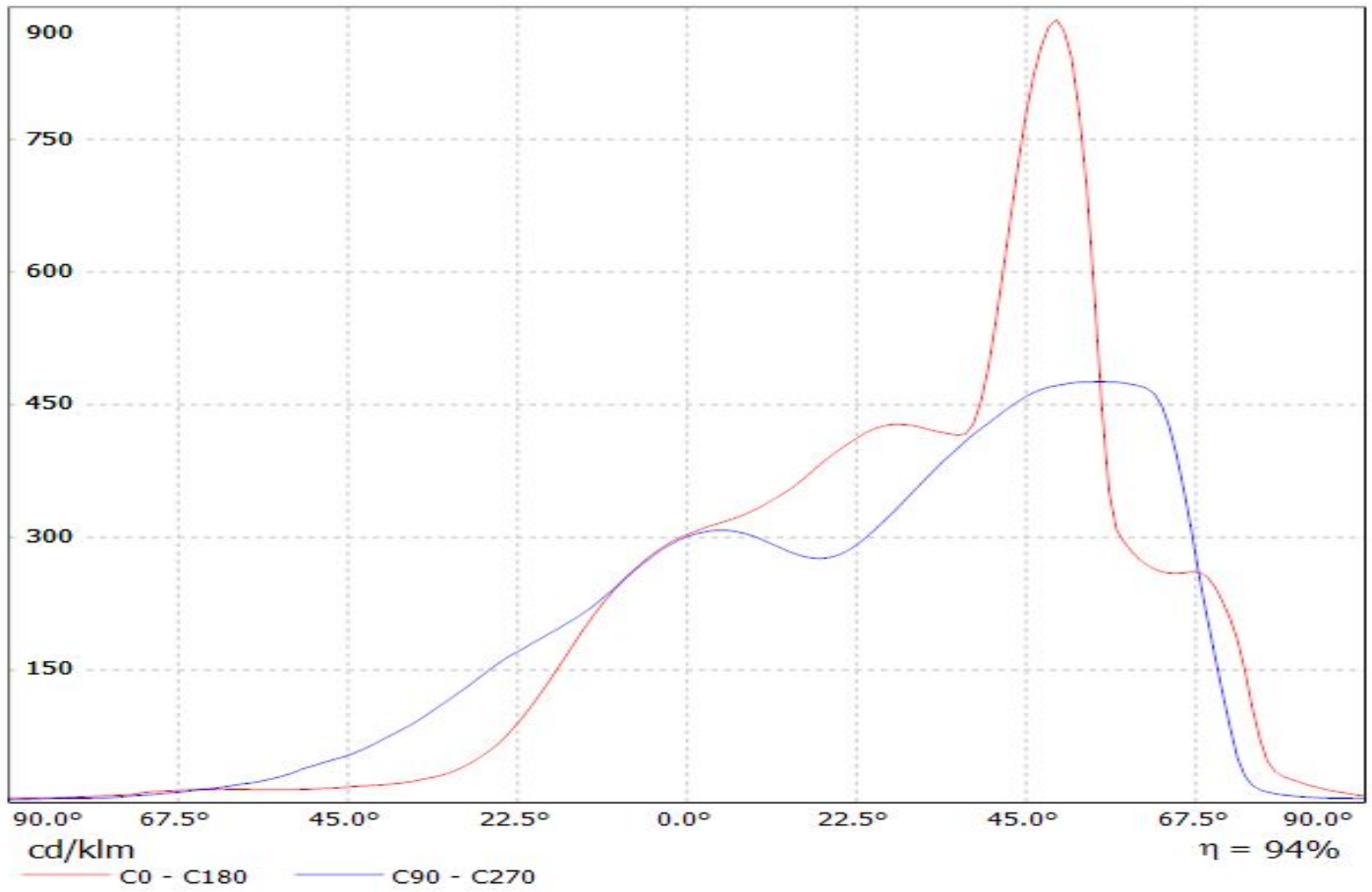

Luminaire: LEDiL Oy C14116\_STRADA-2x2-PX (ACRICH\_MJT\_4040)  
Lamps: 1 x SEOUL\_ACRICH\_MJT\_4040\_2x2\_(SAW09H0A)  
\_131.93lm@250mA\_P=1.12281W\_I=19.5mA

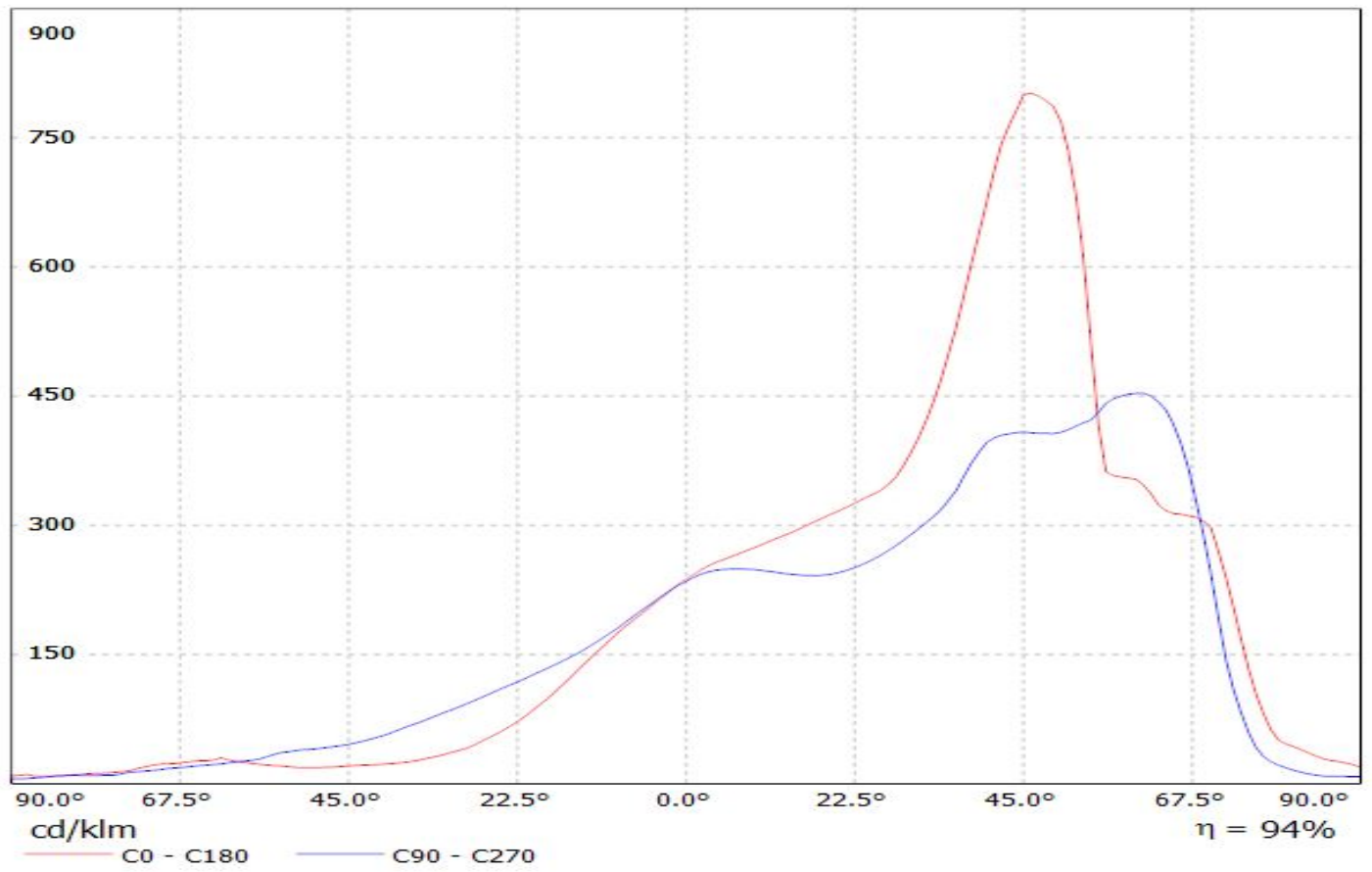

Luminaire: LEDiL Oy C14116\_STRADA-2X2-PX\_(XP-E2)

Lamps: 1 x CREE\_XP-E2\_2x2\_(XPEBWT-L1-7B4-Q4-0-01)\_340.5lm@250mA\_P=2.93108W\_I=249.9mA

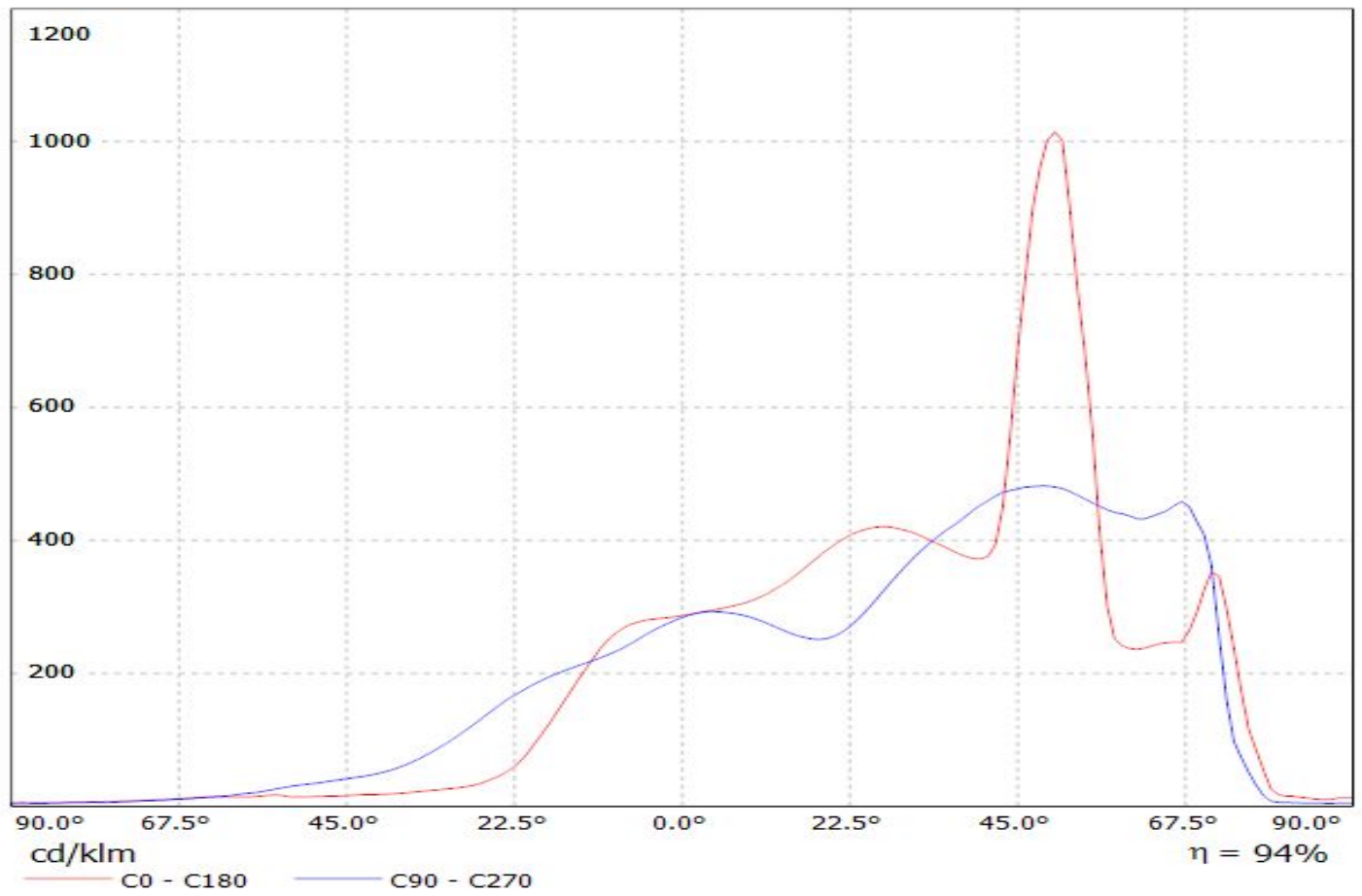

Luminaire: LEDiL Oy C14116\_STRADA-2X2-PX\_(XP-G)

Lamps: 1 x CREE\_XP-G\_2x2\_259.15lm@250mA\_P=2.90609W\_I=249.9mA

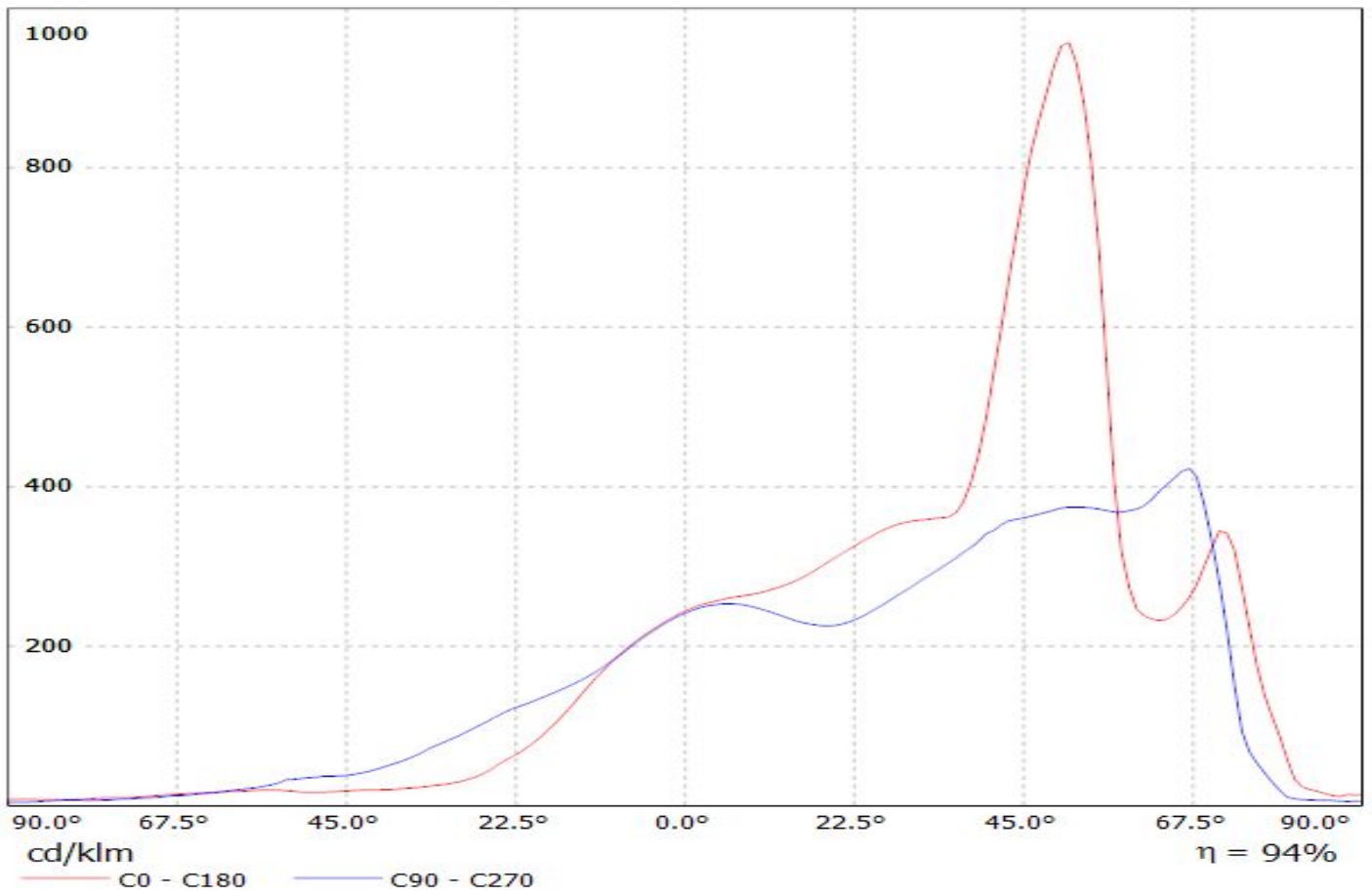

Luminaire: LEDiL Oy C14116\_STRADA-2X2-PX\_(XB-H)  
Lamps: 1 x Cree\_XB-H\_2x2\_(XBHAWT-0-5A3-T50-0L-0001)  
\_442.65lm@250mA\_P=2.96762W\_I=249.8mA

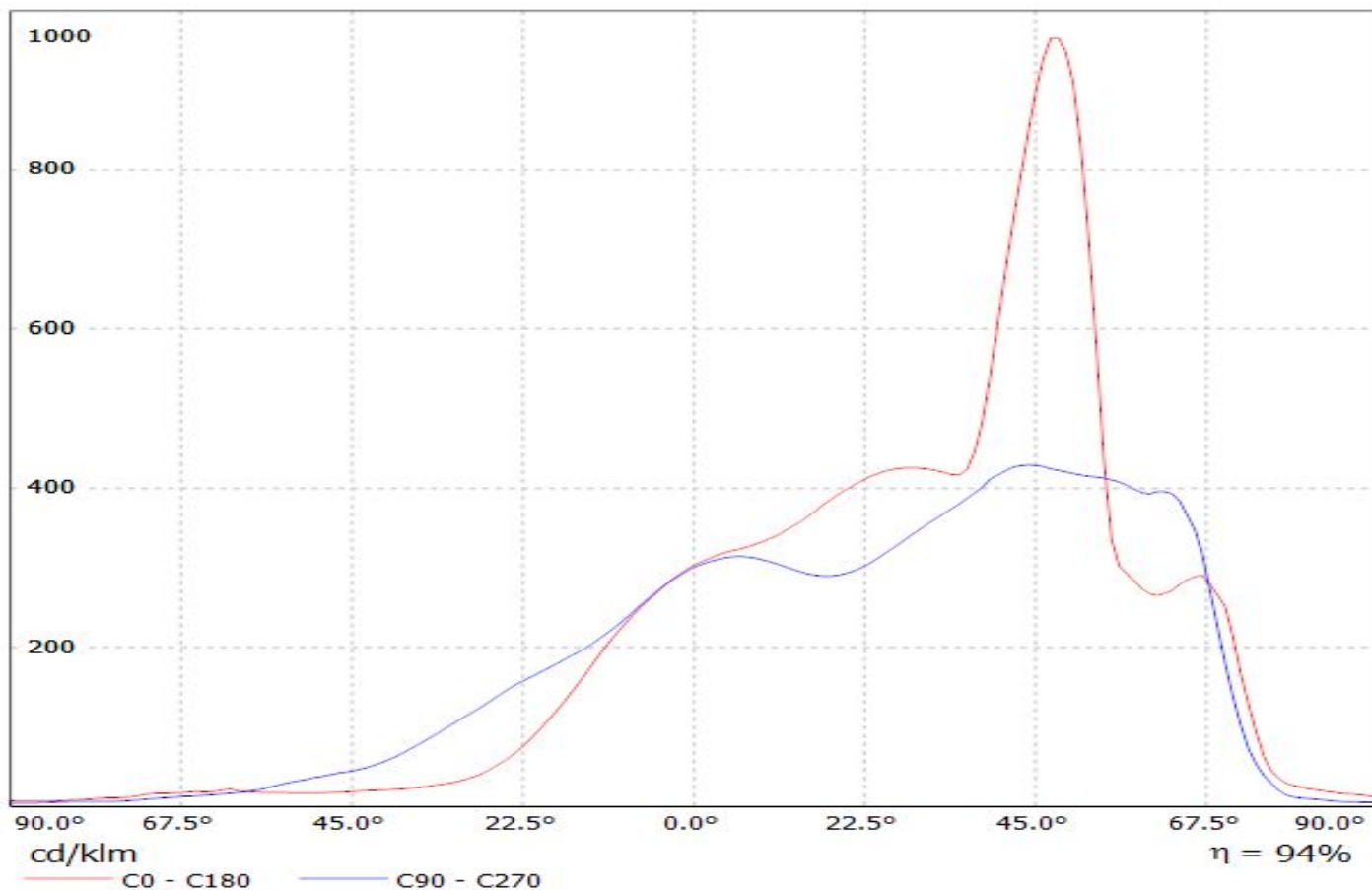

Luminaire: LEDiL Oy C14116\_STRADA-2X2-PX\_(XP-L)  
Lamps: 1 x CREE\_XP-L\_2x2\_(XPLAWT-0-1B0-V40-00-0001)  
\_508.5lm@250mA\_CCT=7600K\_P=2.80563W\_I=249.9mA

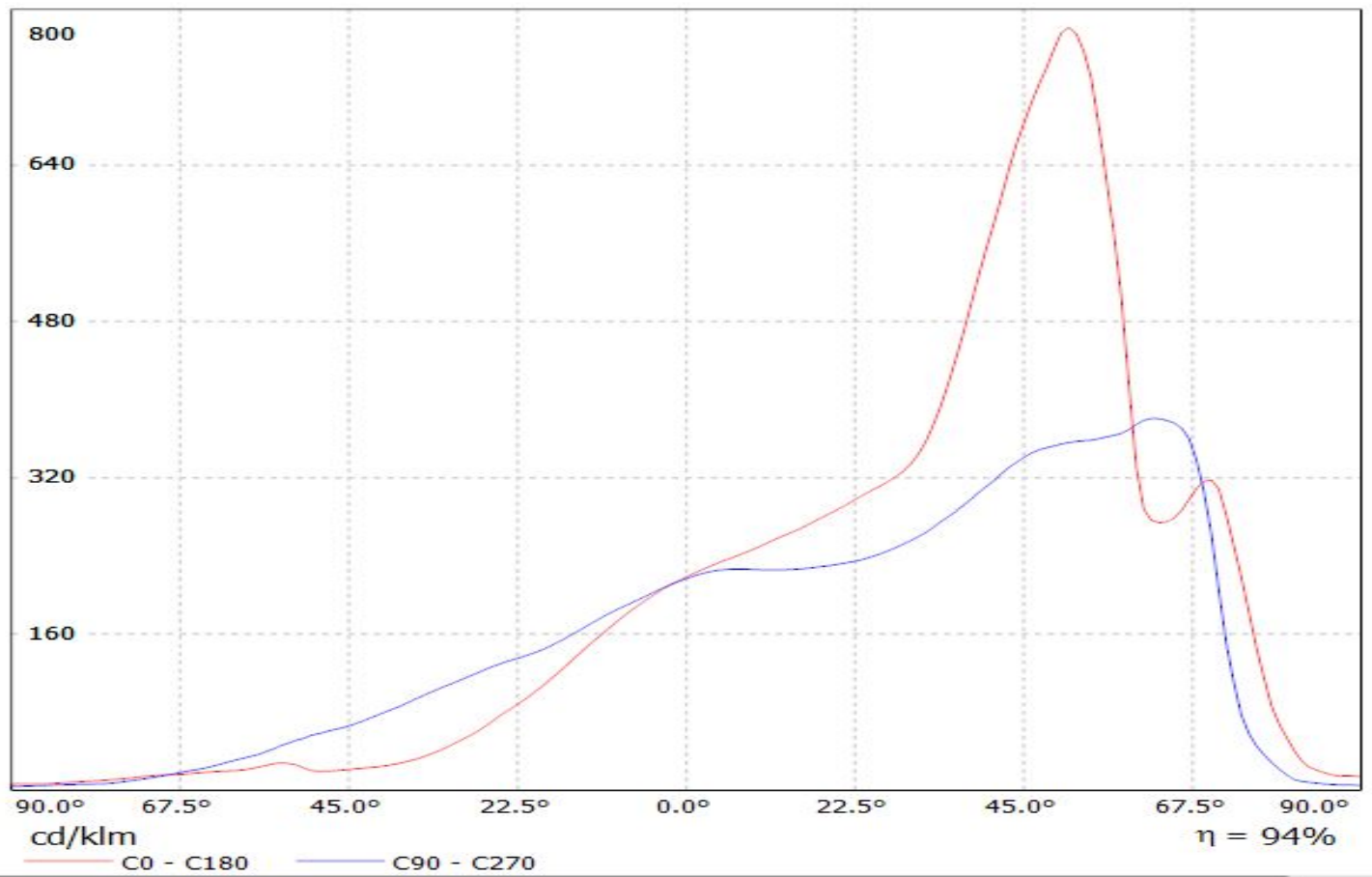



Luminaire: LEDiL Oy C14116\_STRADA-2X2-PX\_(LUXEON\_R)  
Lamps: 1 x LUXEON\_R\_2x2\_(LXA7-PW30)\_314.95lm@250mA\_P=2.78414W\_I=249.9mA

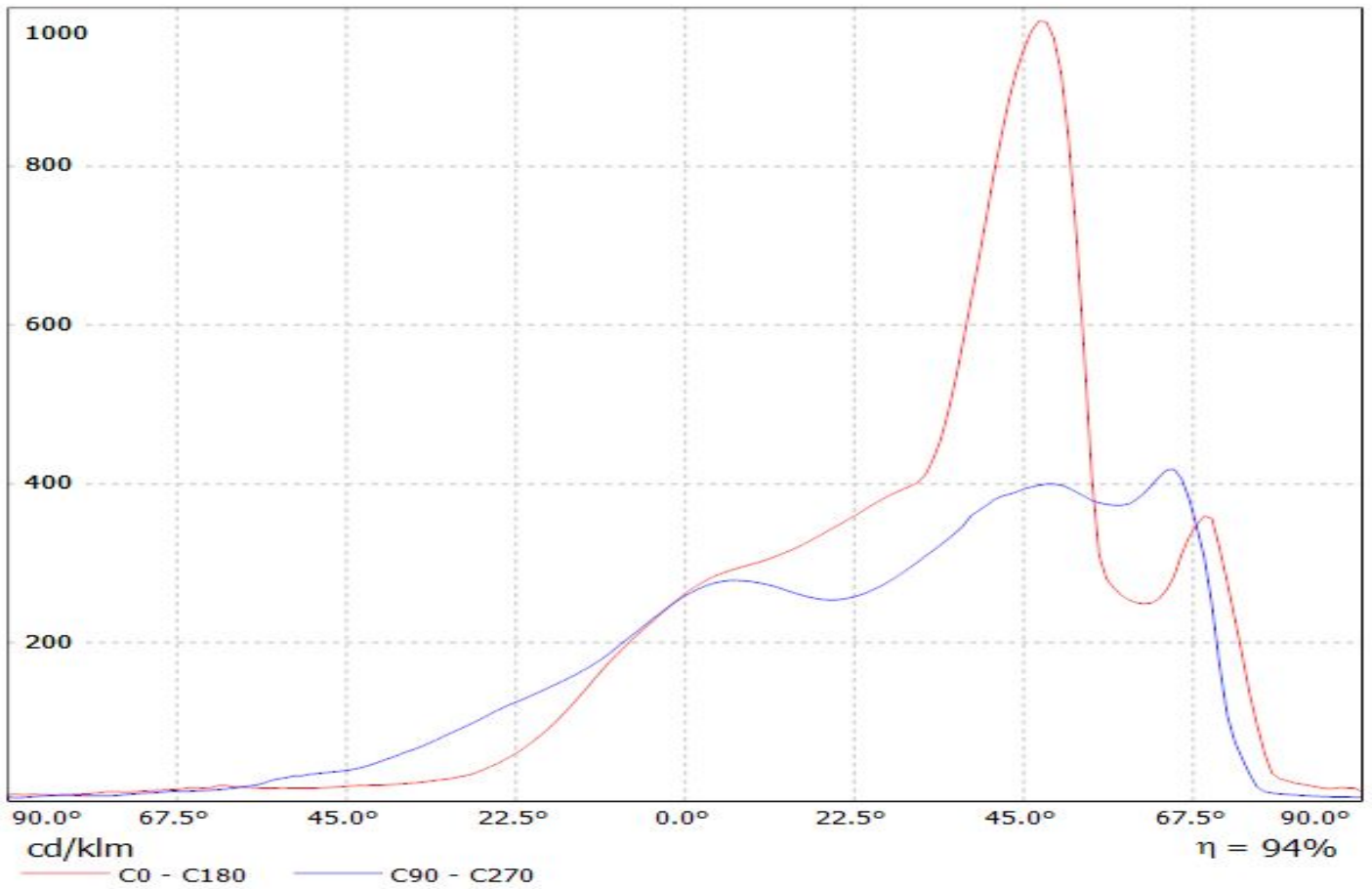

Luminaire: LEDiL Oy C14116\_STRADA-2X2-PX (Z\_ES)

Lamps: 1 x Luxeon\_Z\_ES\_2x2\_(LXZ2-3090)\_214.14lm@250mA\_P=2.82437W\_I=249.9mA

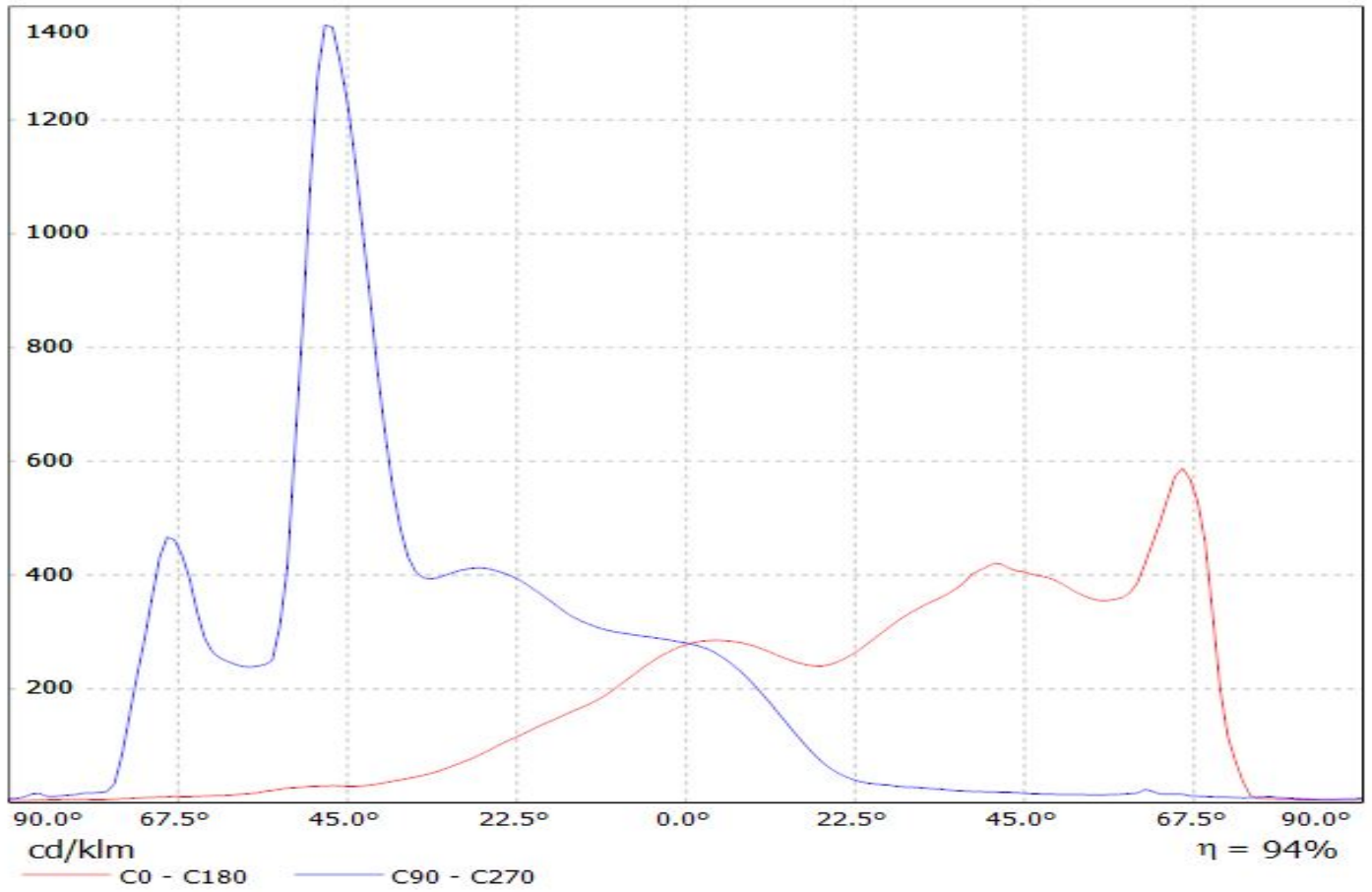

Luminaire: LEDiL Oy C14116\_STRADA-2X2-PX\_(NCSxx19A)  
Lamps: 1 x Nichia\_NCSxx19A\_(NCS119AT-H1)  
\_234.37lm@250mA\_CCT=2830K\_P=3.07452W\_I=249.9mA

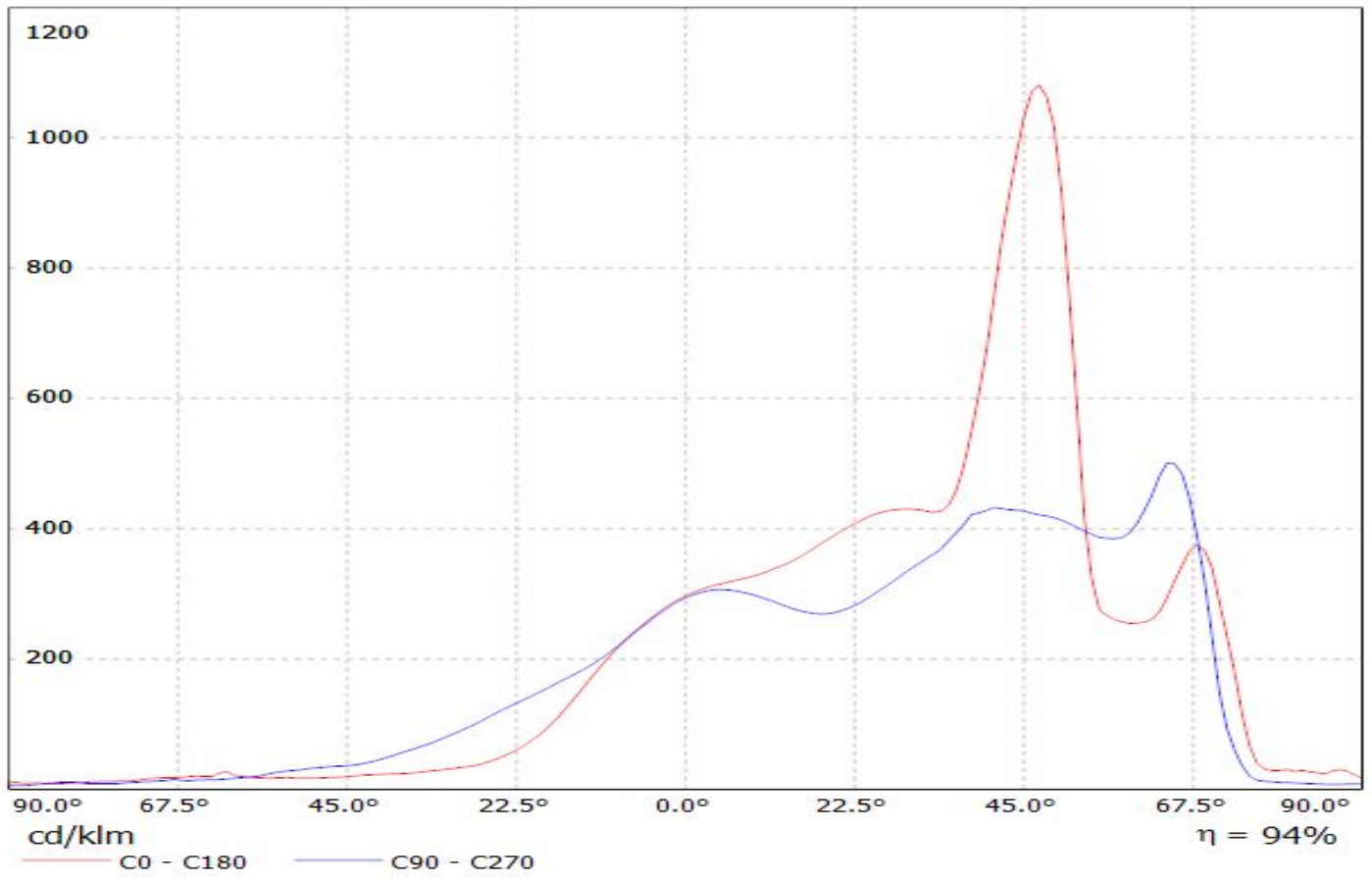

Luminaire: LEDiL Oy C14116\_STRADA-2X2-PX\_(NVSxx19A)

Lamps: 1 x Nichia\_NVsxx19A\_(NVS219AT)\_392.14lm@250mA\_P=2.91991W\_I=249.8mA

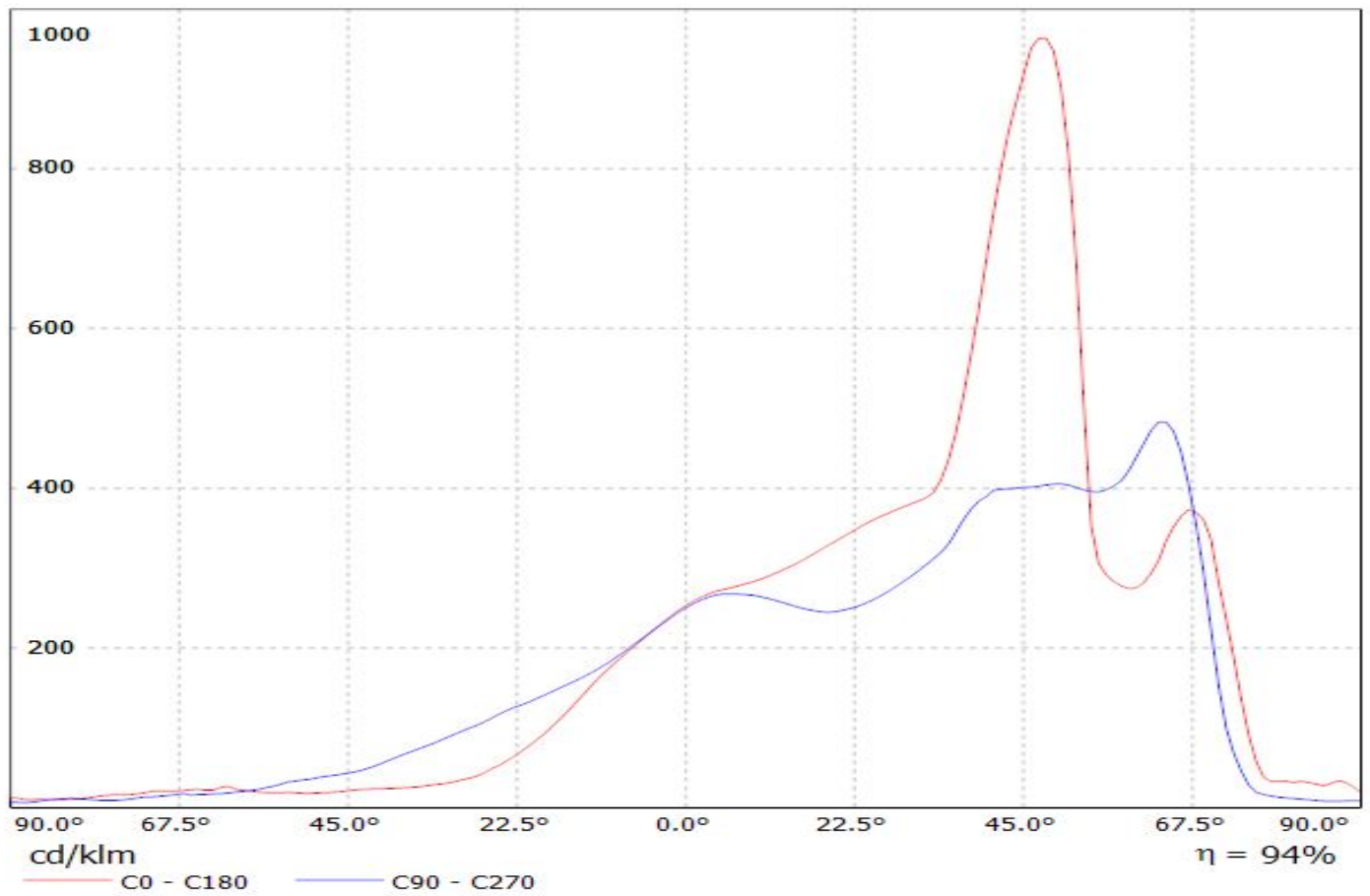

Luminaire: LEDiL Oy C14116\_STRADA-2X2-PX\_(LUXEON\_Q)

Lamps: 1 x LUXEON\_Q\_2x2\_(LHQ-3080)\_306.14lm@250mA\_P=2.88419W\_I=249.8mA

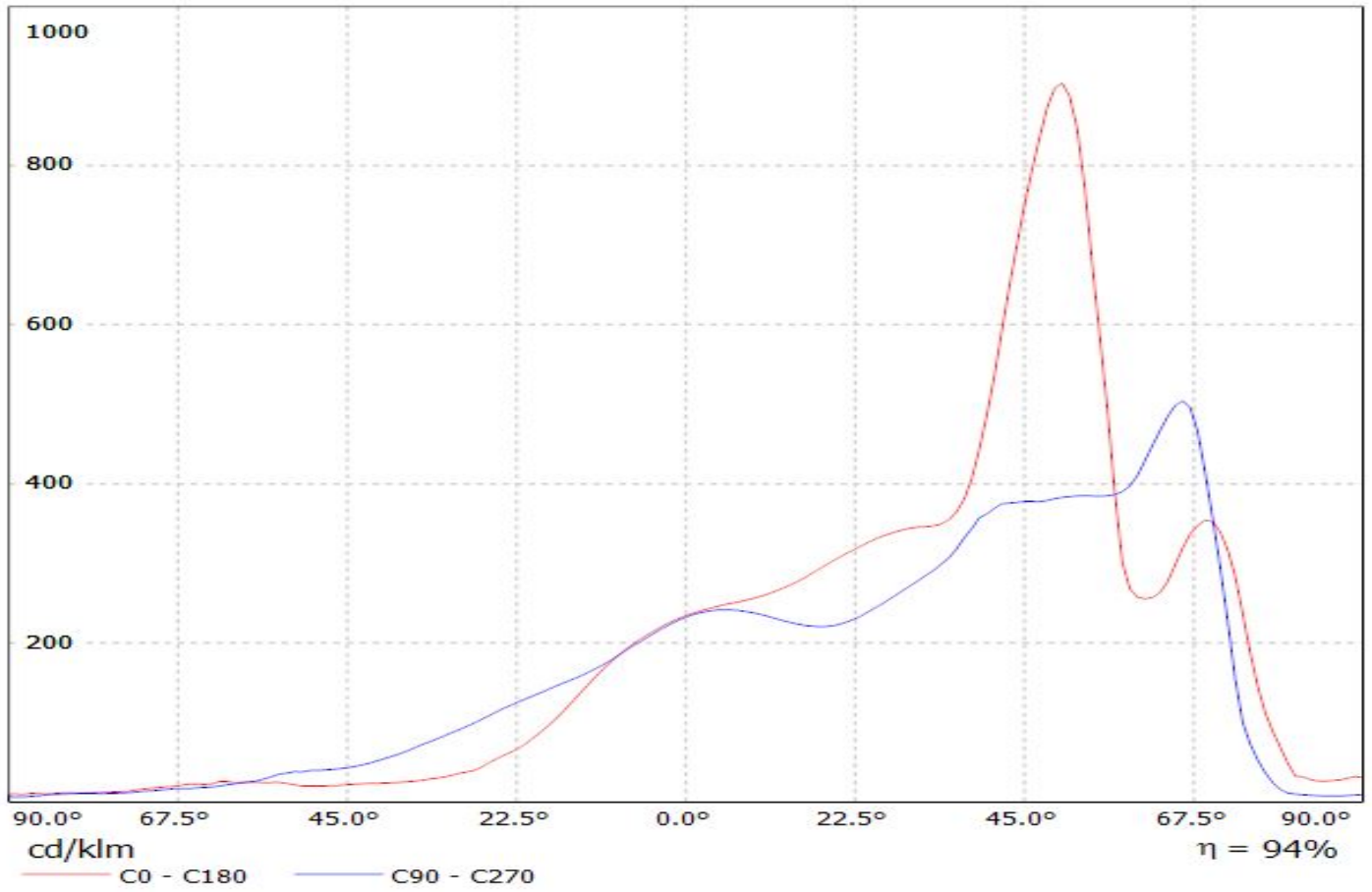

Luminaire: LEDiL Oy C14116\_STRADA-2X2-PX\_(LUXEON\_TX)

Lamps: 1 x LUXEON\_TX\_2x2\_(L1T2-3585)\_327.05lm@250mA\_P=2.79476W\_I=249.8mA

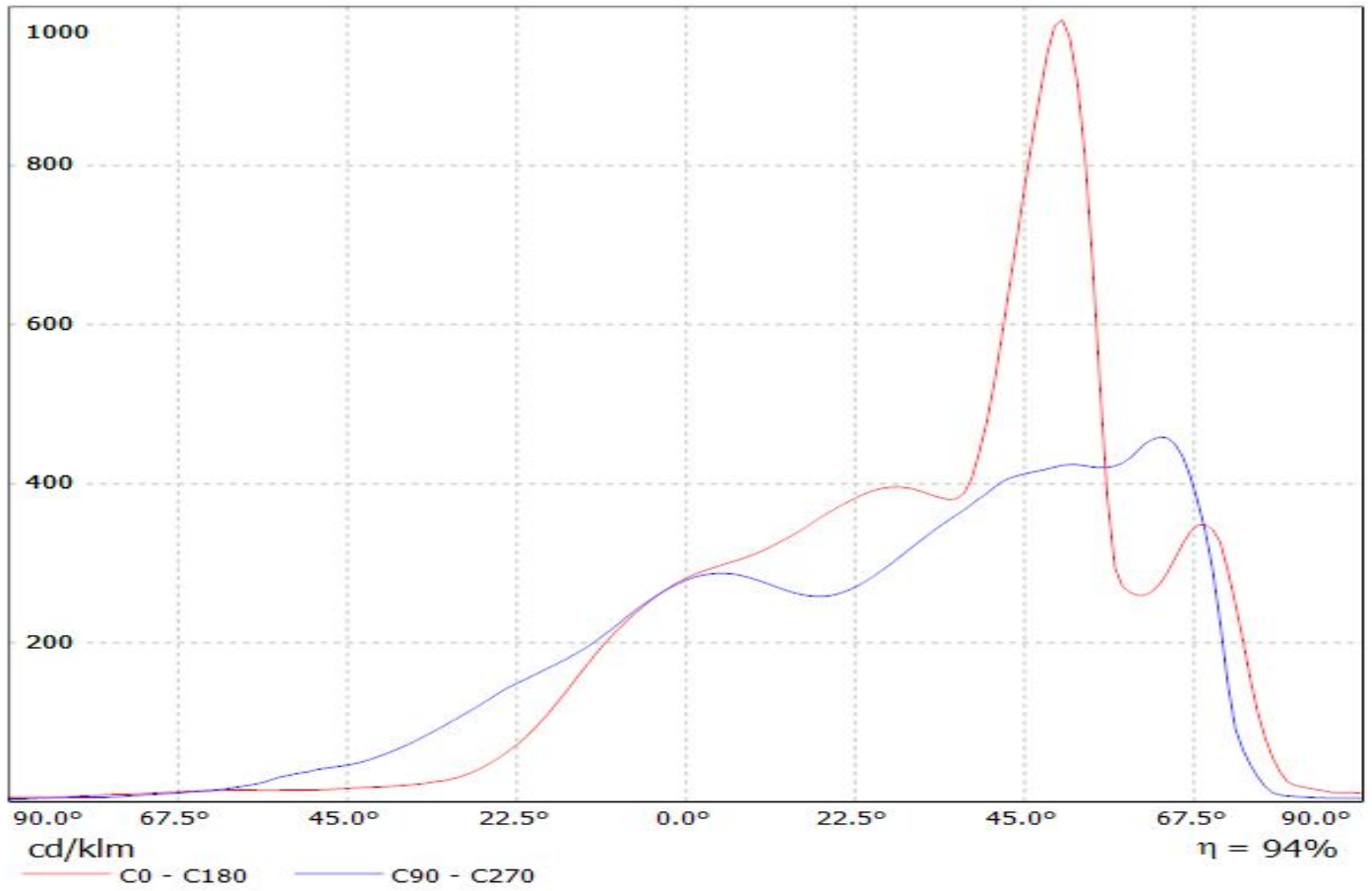

# Ledil C14116\_STRADA-2X2-PX\_(TL1L3) / LDC (Polar)

Luminaire: Ledil C14116\_STRADA-2X2-PX\_(TL1L3)

Lamps: 1 x Toshiba\_TL1L3\_2x2\_(TL1L3-NW1.L)\_387.773lm@250mA\_CCT=5000K\_P=2.829W\_I=0.25A

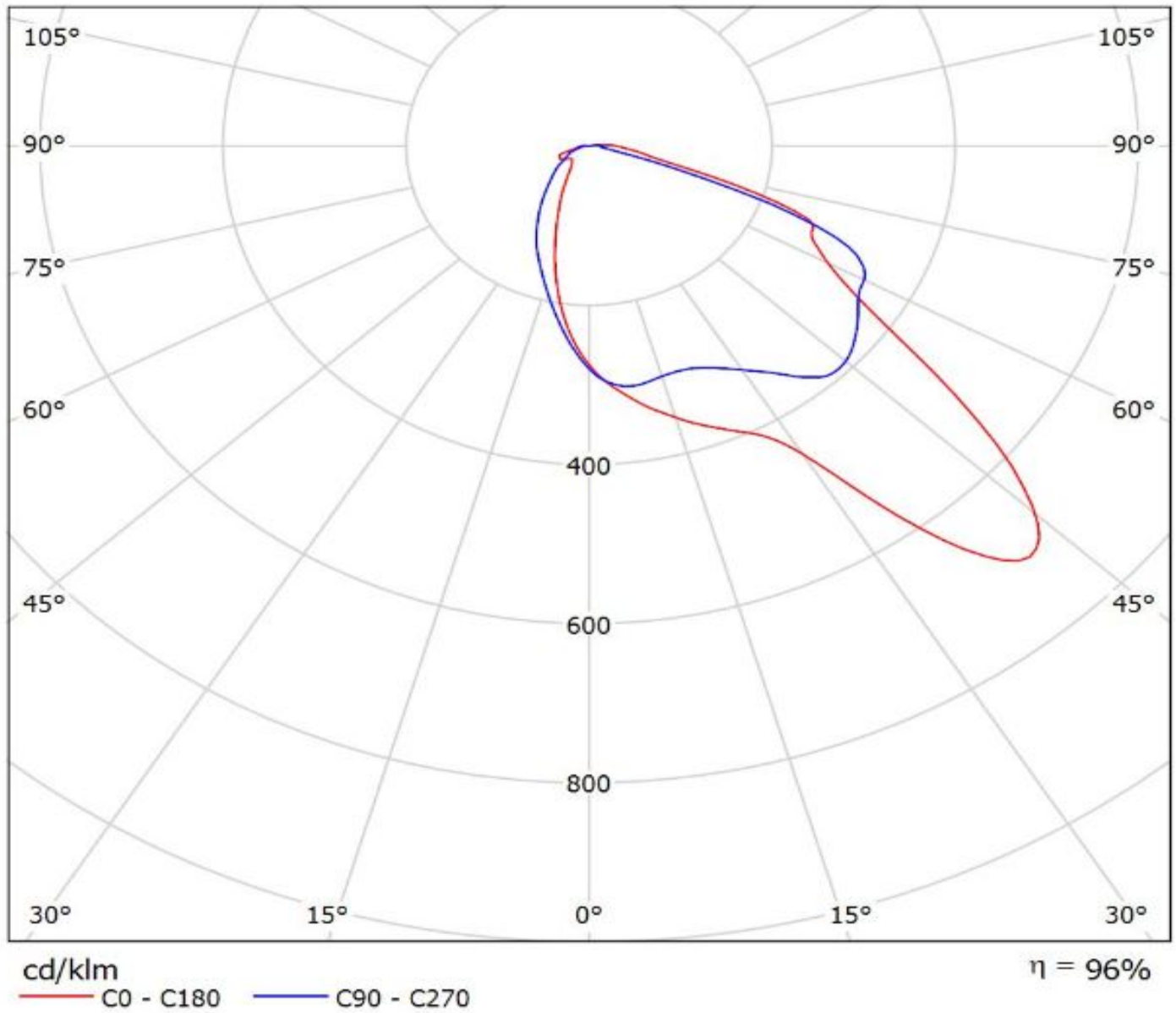



Luminaire: LEDiL Oy C14116\_STRADA-2X2-PX\_(XT-E)

Lamps: 1 x CREE\_XT-E\_2x2\_390.75lm@250mA\_CCT=5717K\_P=2.99855W\_I=249.9mA

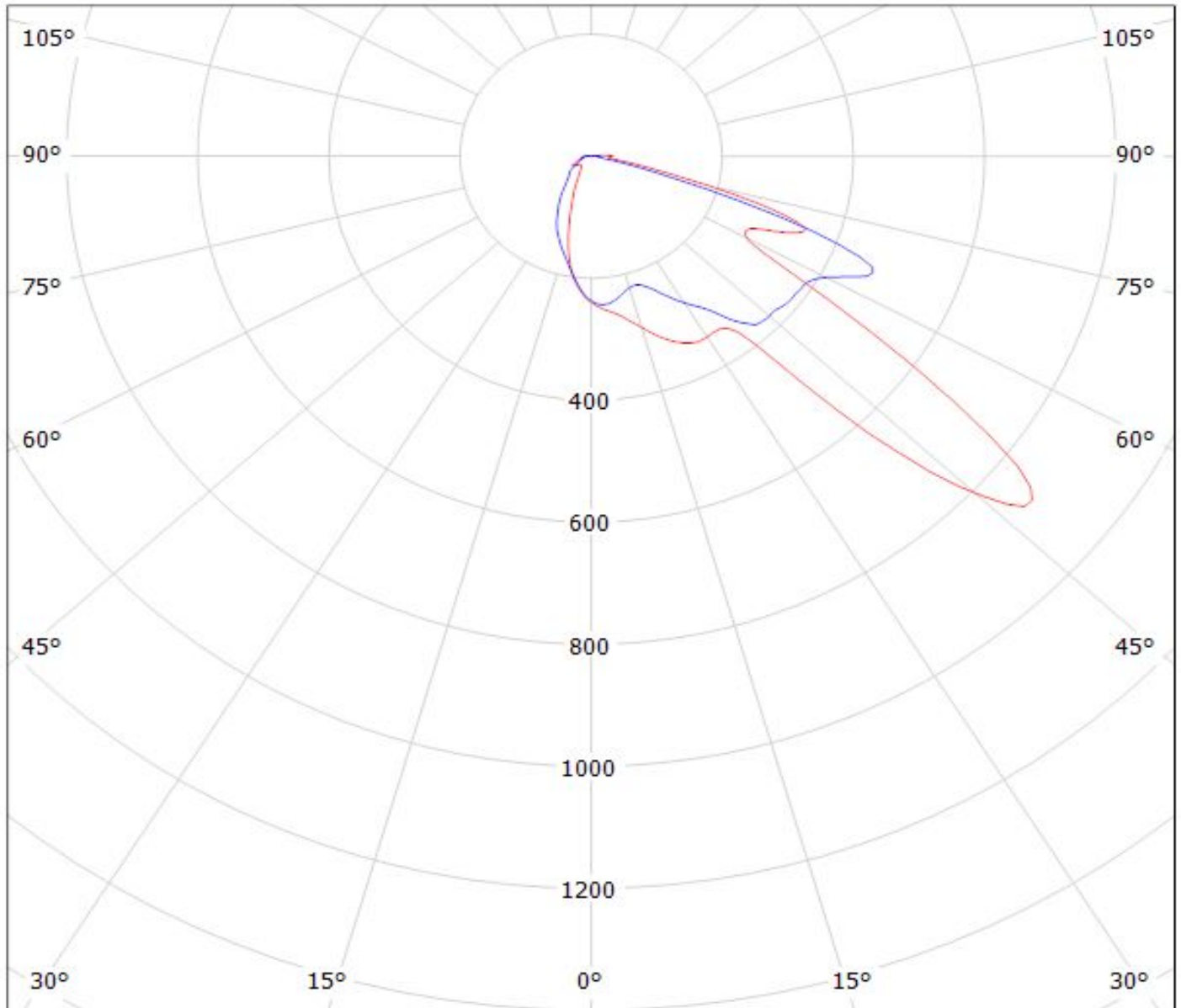

cd/klm

— C0 - C180

— C90 - C270

$\eta = 94\%$



Luminaire: LEDiL Oy C14116\_STRADA-2X2-PX\_(XM-L2)  
Lamps: 1 x CREE\_XM-L2\_2x2\_(XMLBWT-0-7B4-T30-0L-001)  
\_361.65lm@250mA\_CCT3220K\_P=2.81924W\_I=249.8mA

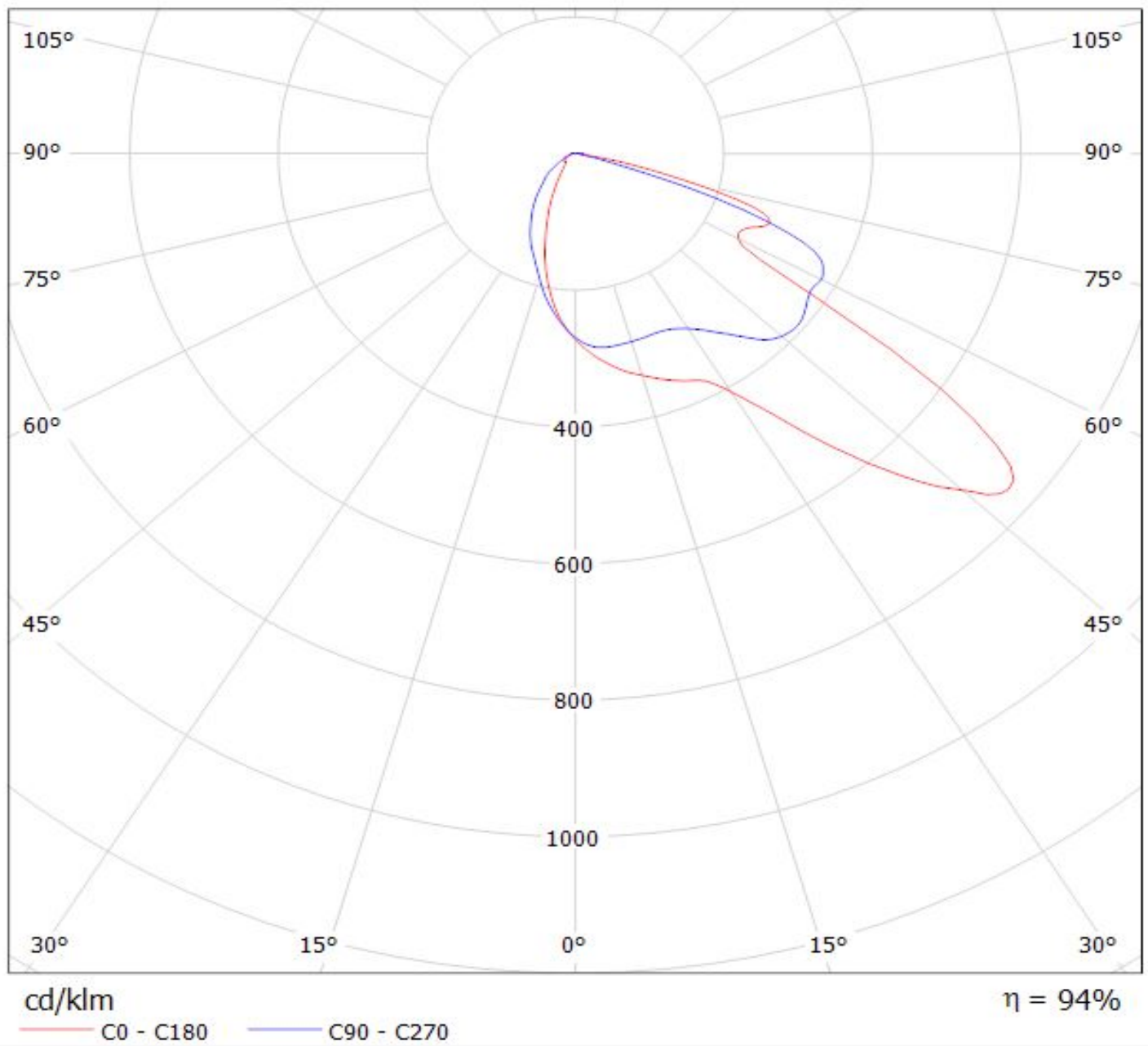

Luminaire: LEDiL Oy C14116\_STRADA-2X2-PX\_(XM-L)

Lamps: 1 x CREE\_XM-L\_2x2\_362.5lm@250mA\_CCT7700K\_P=2.83911W\_I=249.9mA

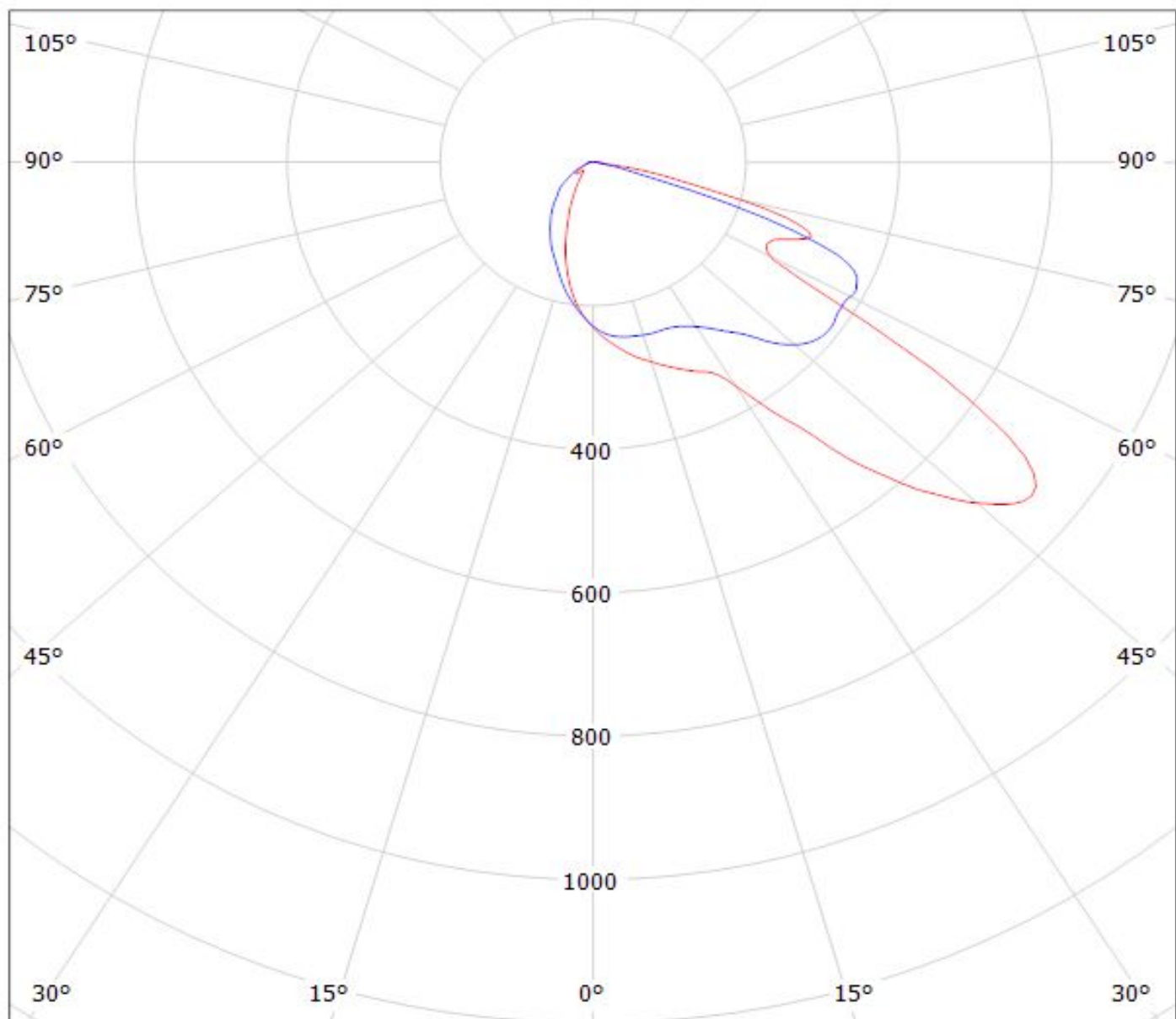

cd/klm

— C0 - C180    — C90 - C270

$\eta = 94\%$

Luminaire: LEDiL Oy C14116\_STRADA-2X2-PX\_(XP-G2)  
Lamps: 1 x CREE\_XP-G2\_2x2\_(XPGBWT-L1-000-00G51)  
\_414.85lm@250mA\_CCT=7181K\_P=2.95563W\_I=249.8mA

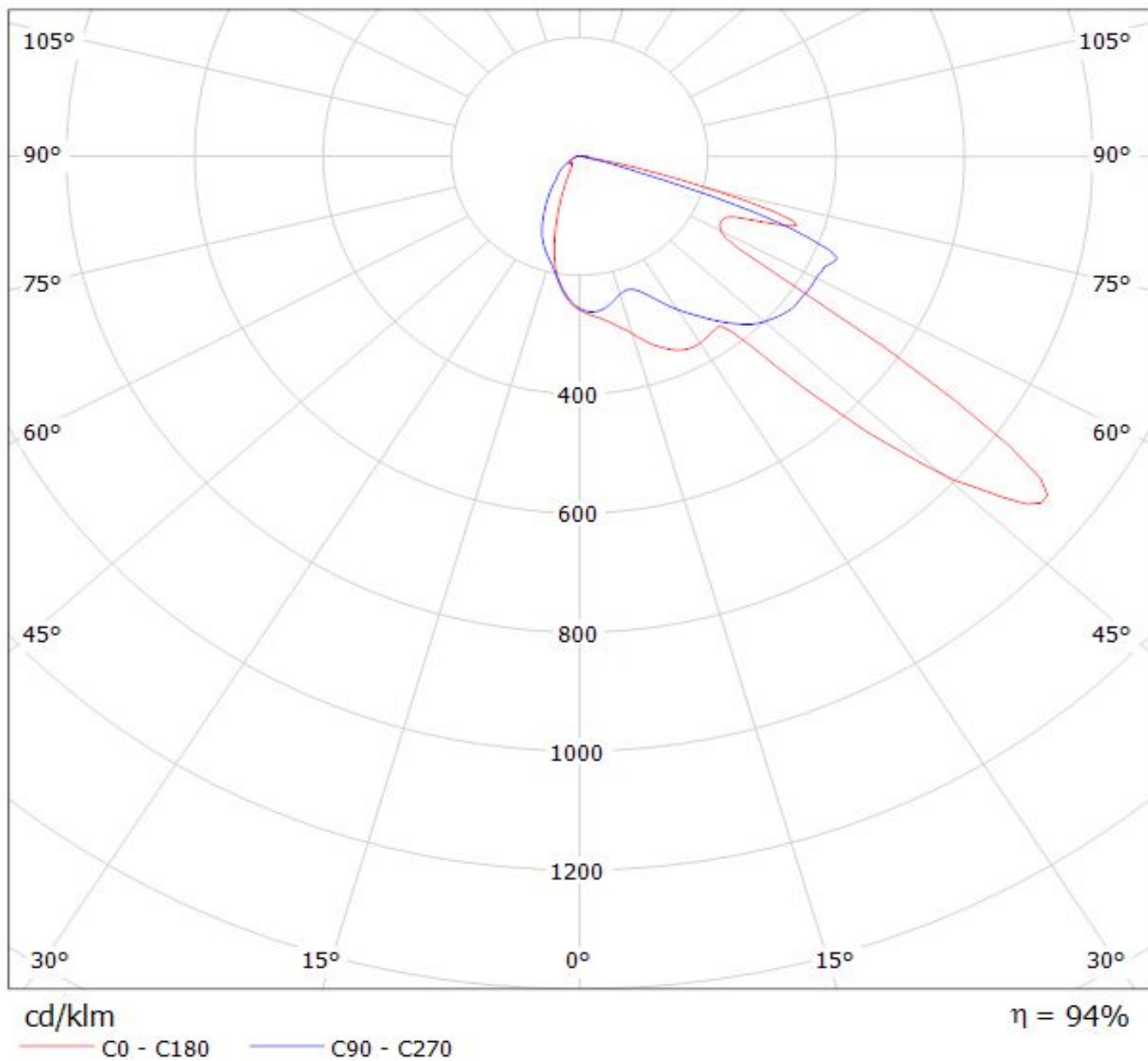

Luminaire: LEDiL Oy C14116\_STRADA-2x2-PX\_(Z5P)

Lamps: 1 x SEOUL\_Z5P\_2x2\_286.1lm@250mA\_P=3.66253W\_I=249.9mA

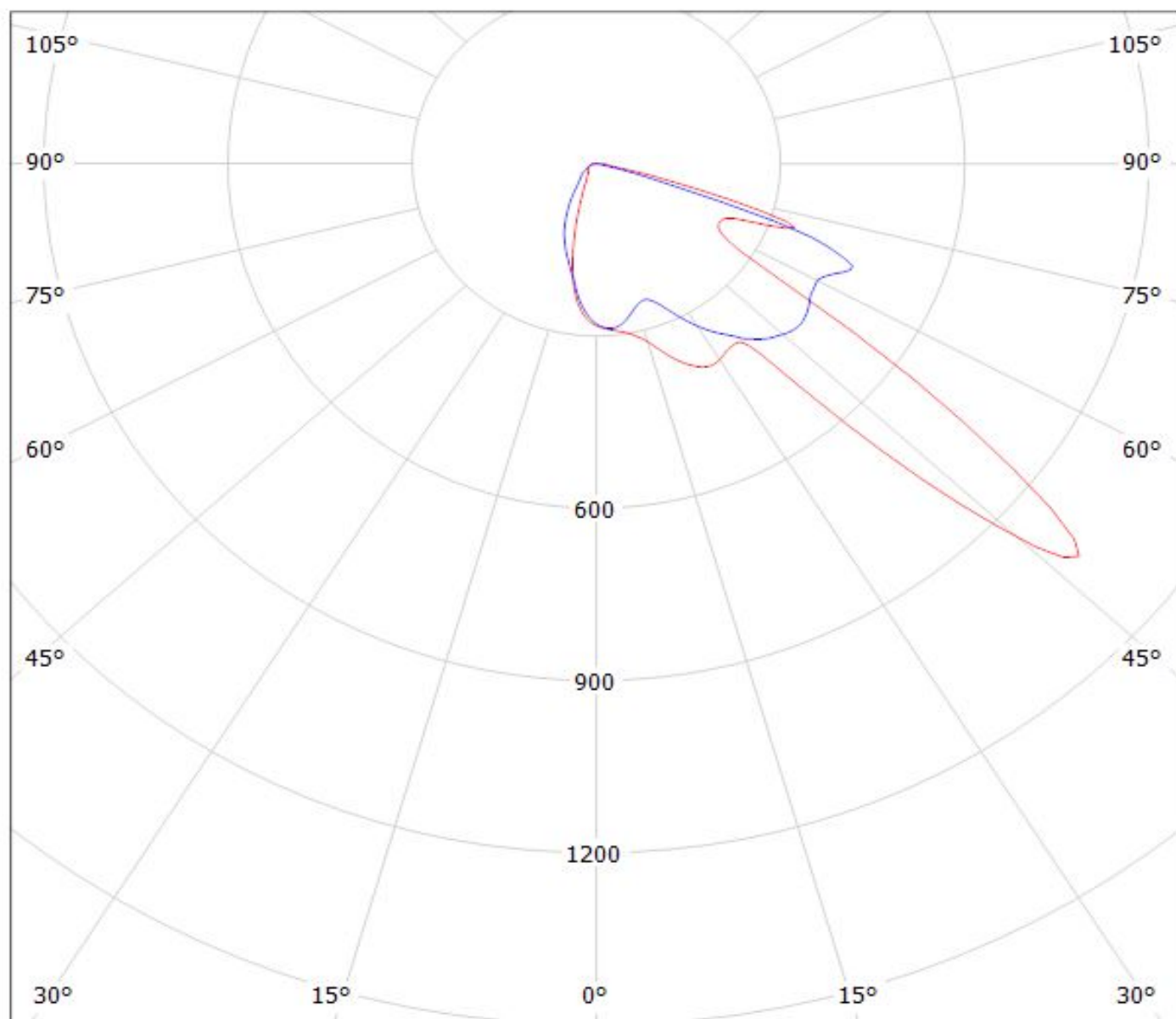

cd/klm

— C0 - C180

— C90 - C270

$\eta = 94\%$

Luminaire: LEDiL Oy C14116\_STRADA-2X2-PX\_(SQ-PC)

Lamps: 1 x OSRAM OSOLON SQUARE\_PC\_2x2\_(LCW\_CQAR.PC-MSMU-5H71-1)

\_423.6lm@250mA\_CCT=5960K\_P=2.86246W\_I=249.8mA

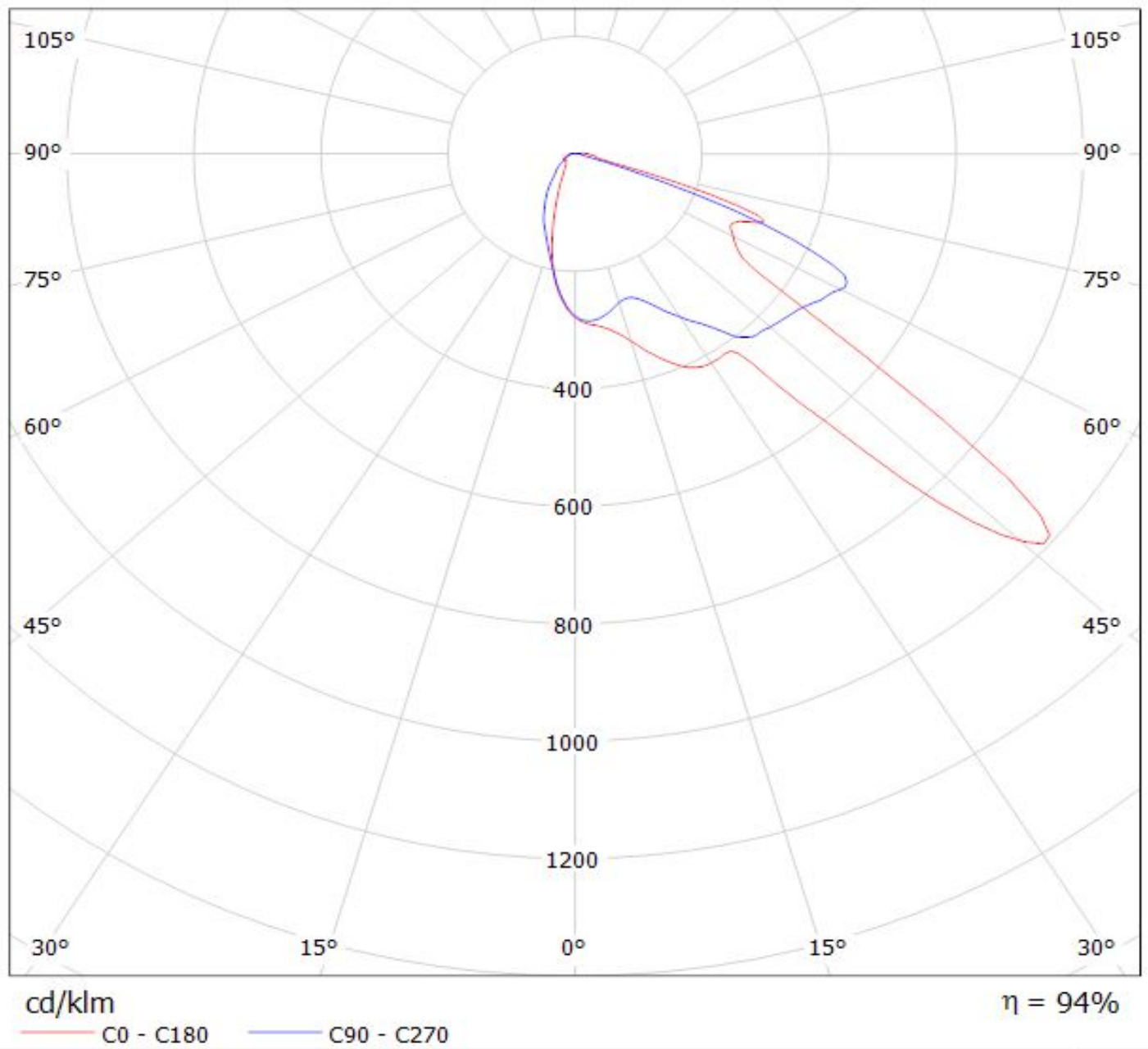

Luminaire: LEDiL Oy C14116\_STRADA-2X2-PX\_(SSL150)

Lamps: 1 x OSLOM\_SSL150\_2x2\_284.9lm@250mA\_CCT=3154K\_P=3.15274W\_I=249.9mA

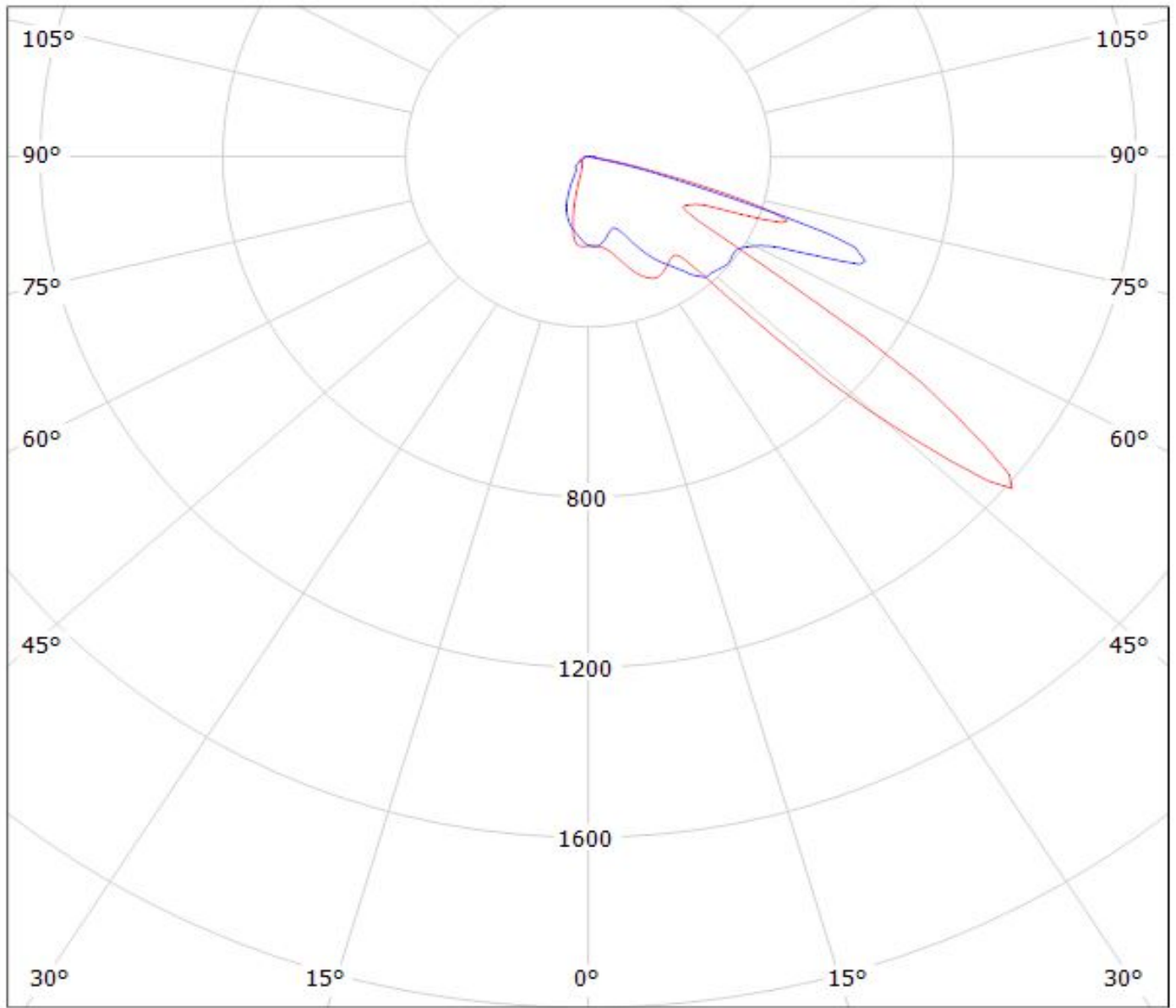

cd/klm

— C0 - C180

— C90 - C270

$\eta = 94\%$



Luminaire: LEDiL Oy C14116\_STRADA-2X2-PX\_(XB-D)

Lamps: 1 x CREE\_XB-D\_2x2\_366.34lm@250mA\_P=3.07877W\_I=249.9mA

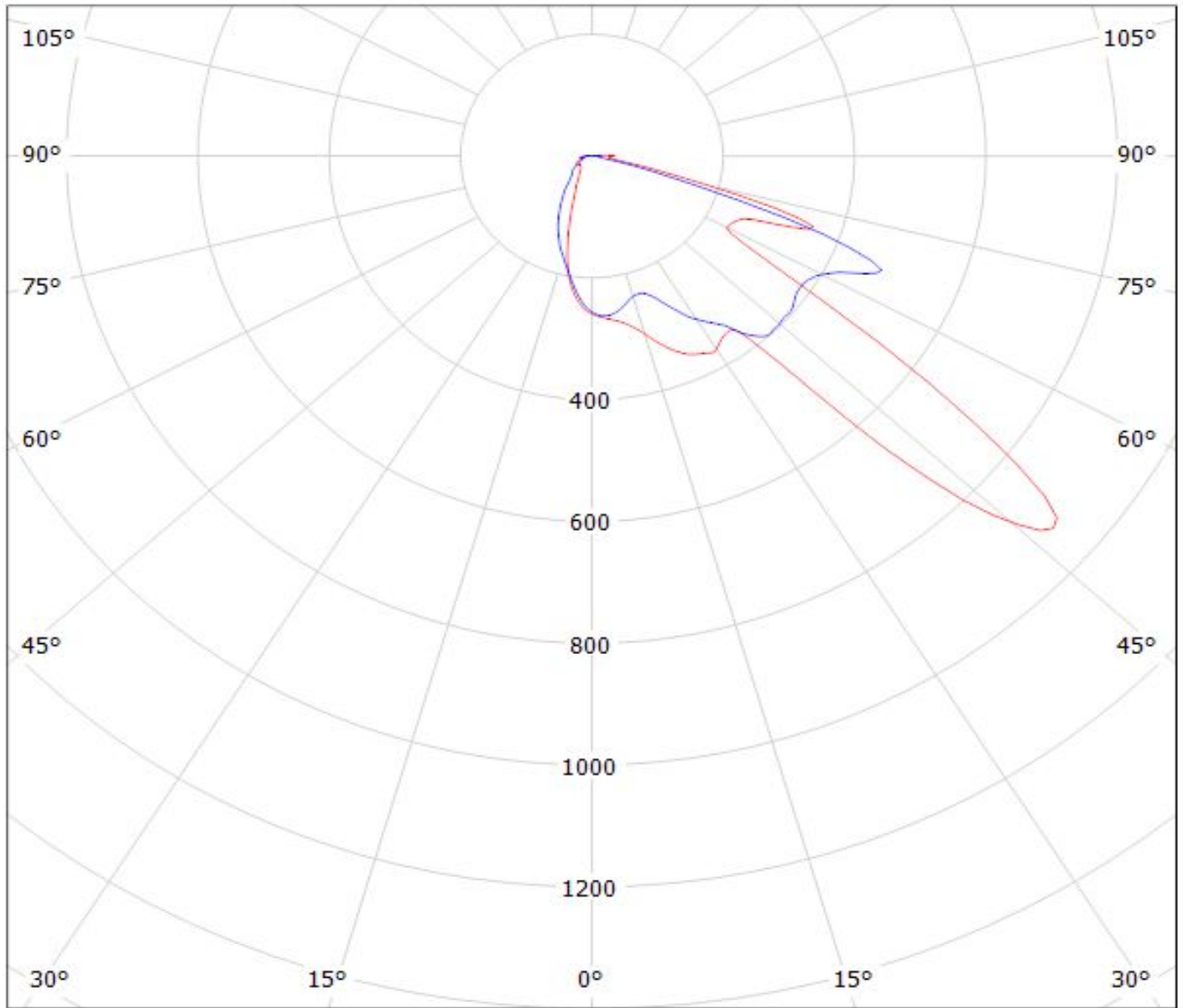

cd/klm

— C0 - C180

— C90 - C270

$\eta = 94\%$

Luminaire: LEDiL Oy C14116\_STRADA-2X2-PX\_(SSL80)

Lamps: 1 x OSLOM\_SSL80\_2x2\_314.4lm@250mA\_CCT=6775K\_P=3.16548W\_I=249.9mA

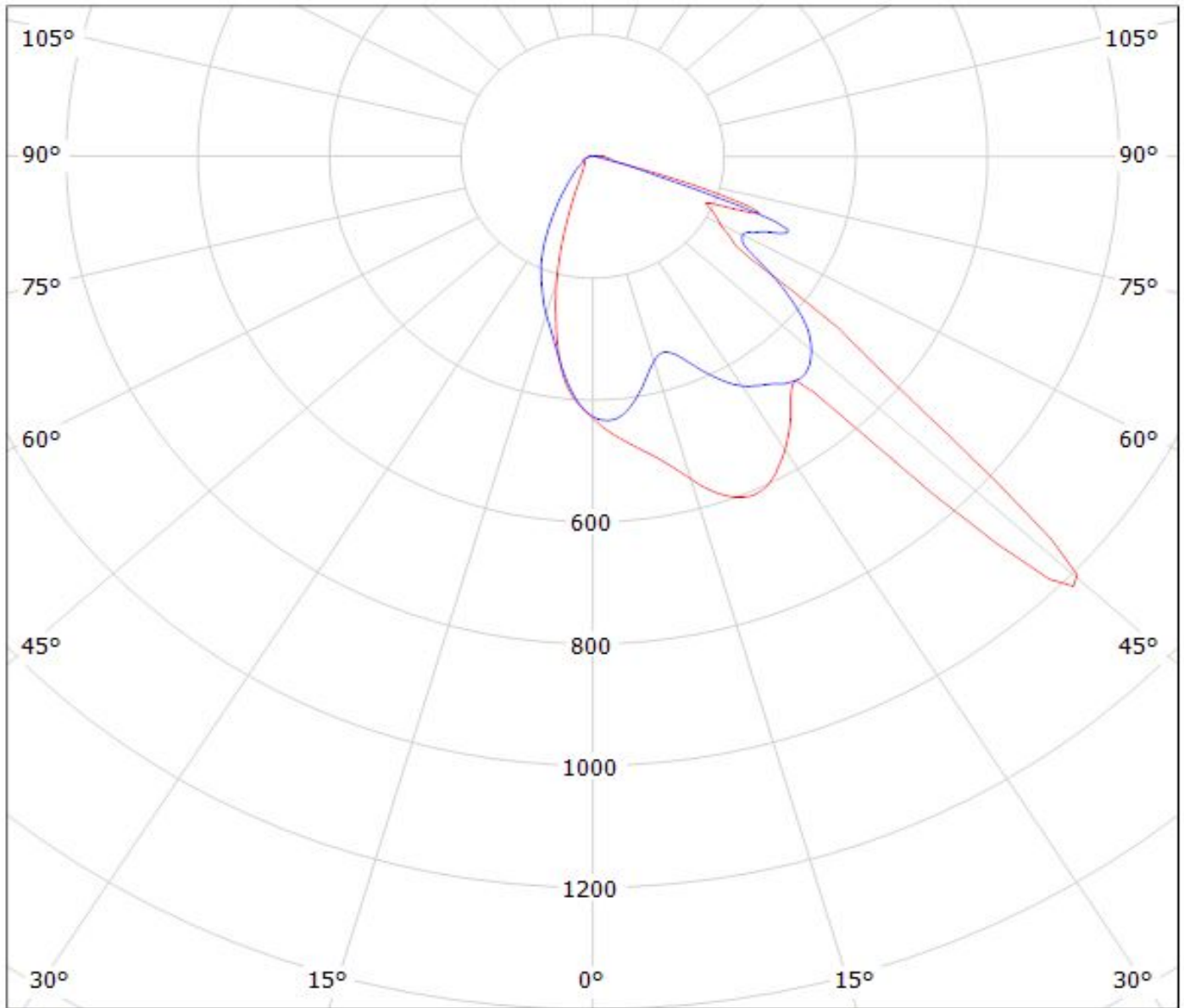

cd/klm

— C0 - C180 — C90 - C270

$\eta = 94\%$



Luminaire: LEDiL Oy C14116\_STRADA-2X2-PX\_(NCSxx19B)  
Lamps: 1 x NICHIA\_NCSxx19B\_(NCSW119BE)  
\_2x2\_439.5lm@250mA\_CCT=5403K\_P=3.0083W\_I=249.9mA

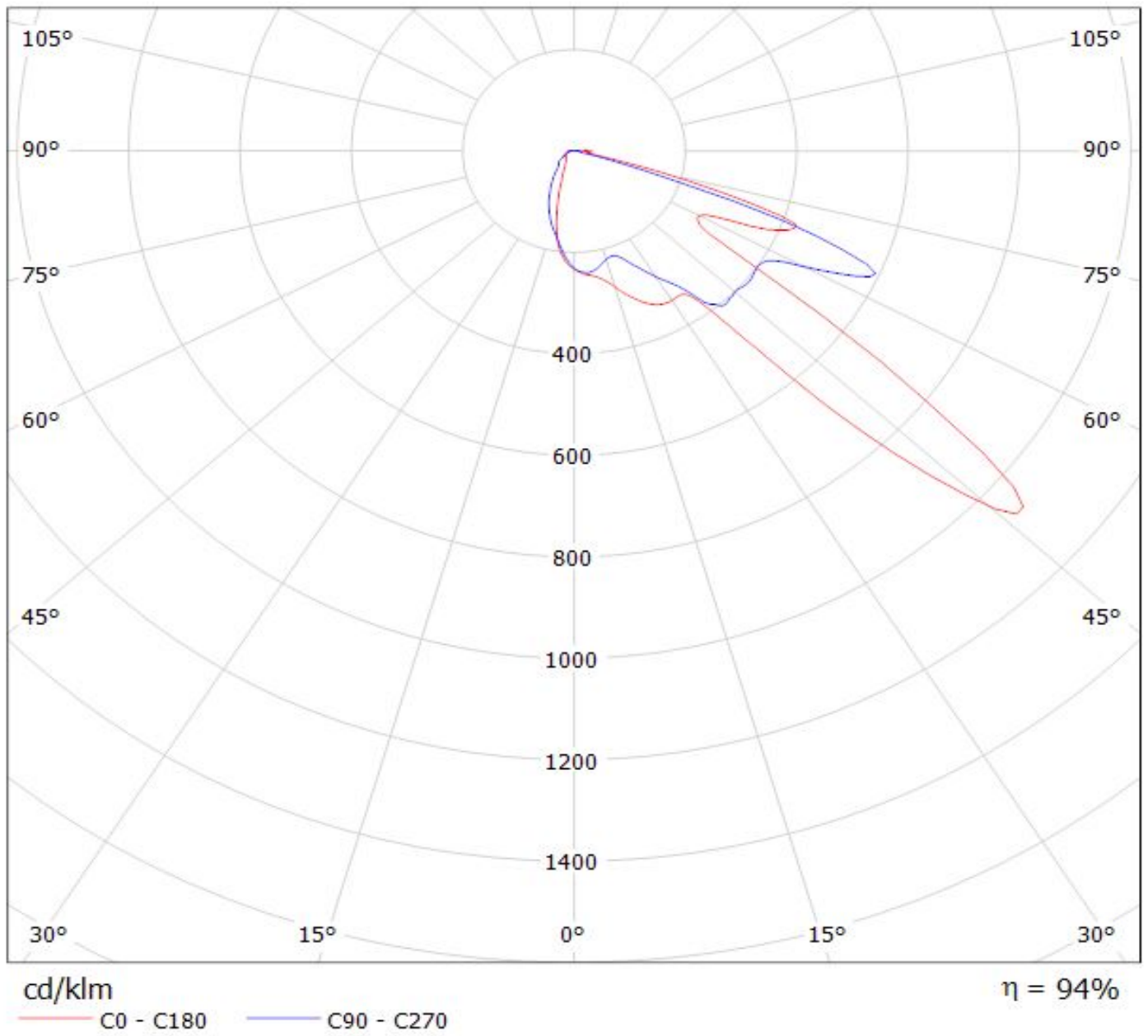

Luminaire: LEDiL Oy C14116\_STRADA-2X2-PX\_(LUXEON\_T)

Lamps: 1 x LUXEON\_T\_2x2\_(LXH8-FW30-3)\_294.67lm@250mA\_P=2.806W\_I=249.8mA

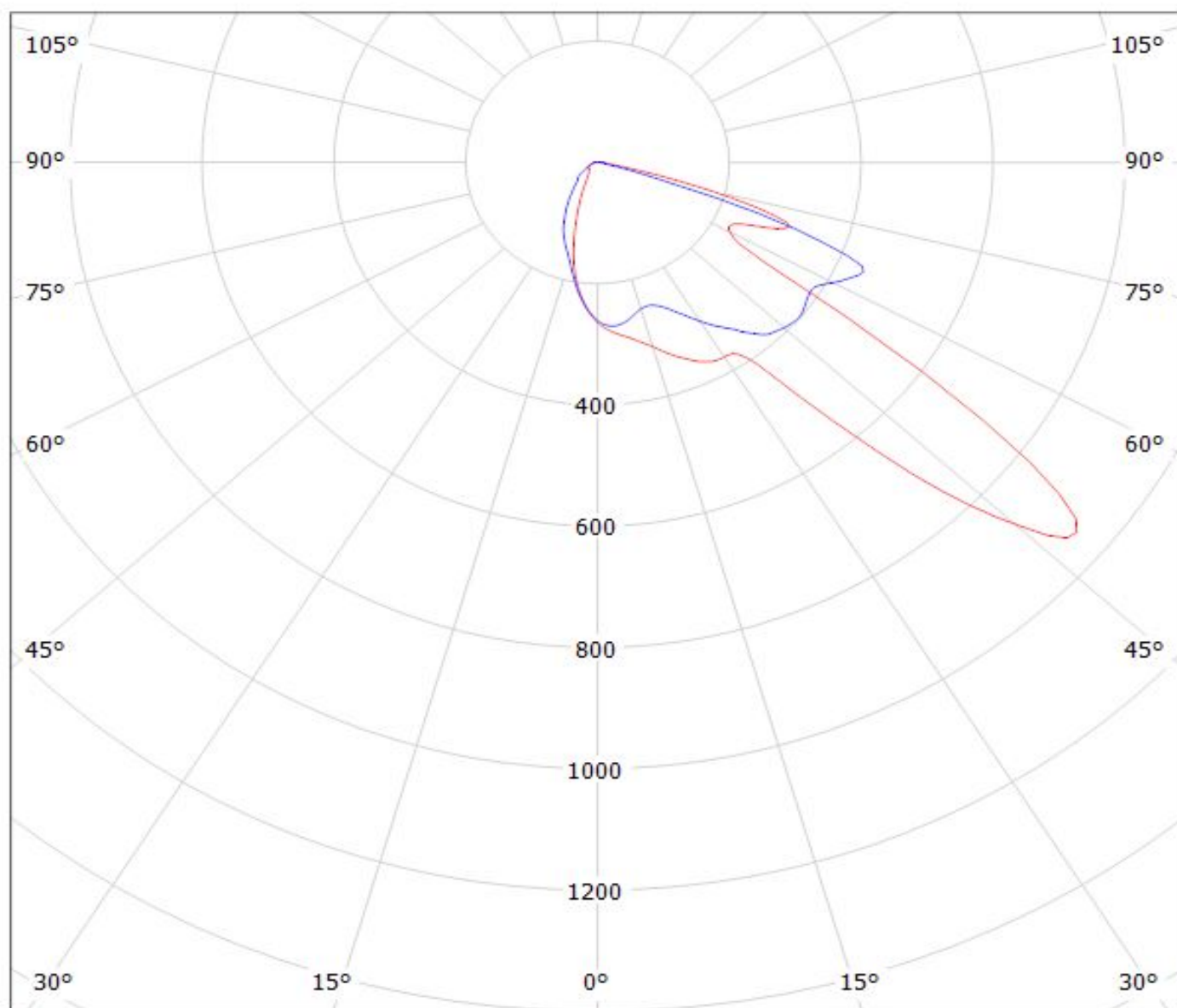

cd/klm

— C0 - C180

— C90 - C270

$\eta = 94\%$

Luminaire: LEDiL Oy C14116\_STRADA-2X2-PX\_(REBEL\_ES)

Lamps: 1 x LUXEON\_REBEL\_ES\_2x2\_340.26lm@250mA\_P=2.87295W\_I=249.8mA

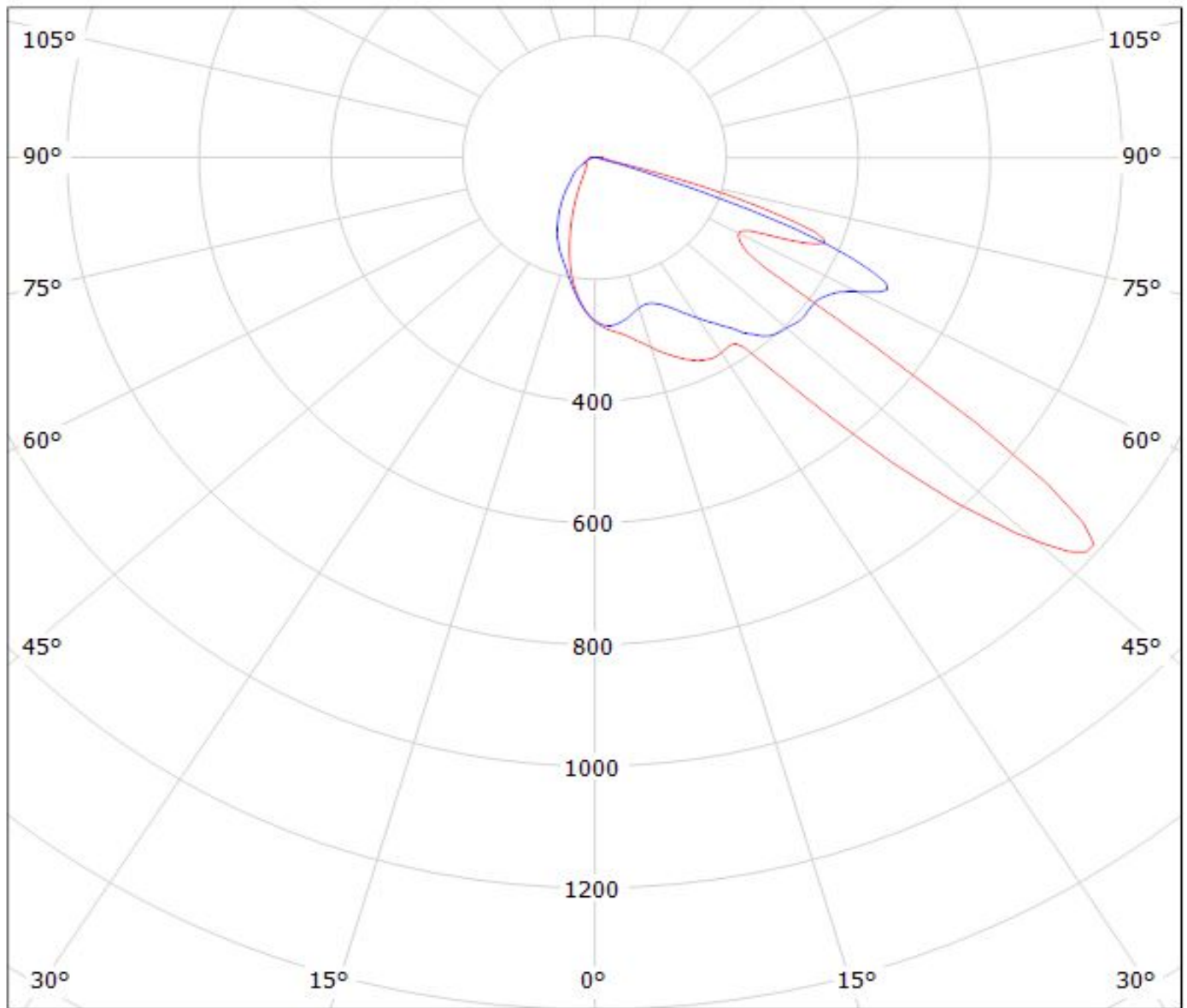

cd/klm

— C0 - C180

— C90 - C270

$\eta = 94\%$

Luminaire: LEDiL Oy C14116\_STRADA-2X2-PX\_(XP-E)  
Lamps: 1 x Cree\_XP-E\_2x2\_(XPEWHT-L1-3C0-Q5-0-06)  
\_305.07lm@250mA\_CCT=5434K\_P=3.06902W\_I=249.9mA

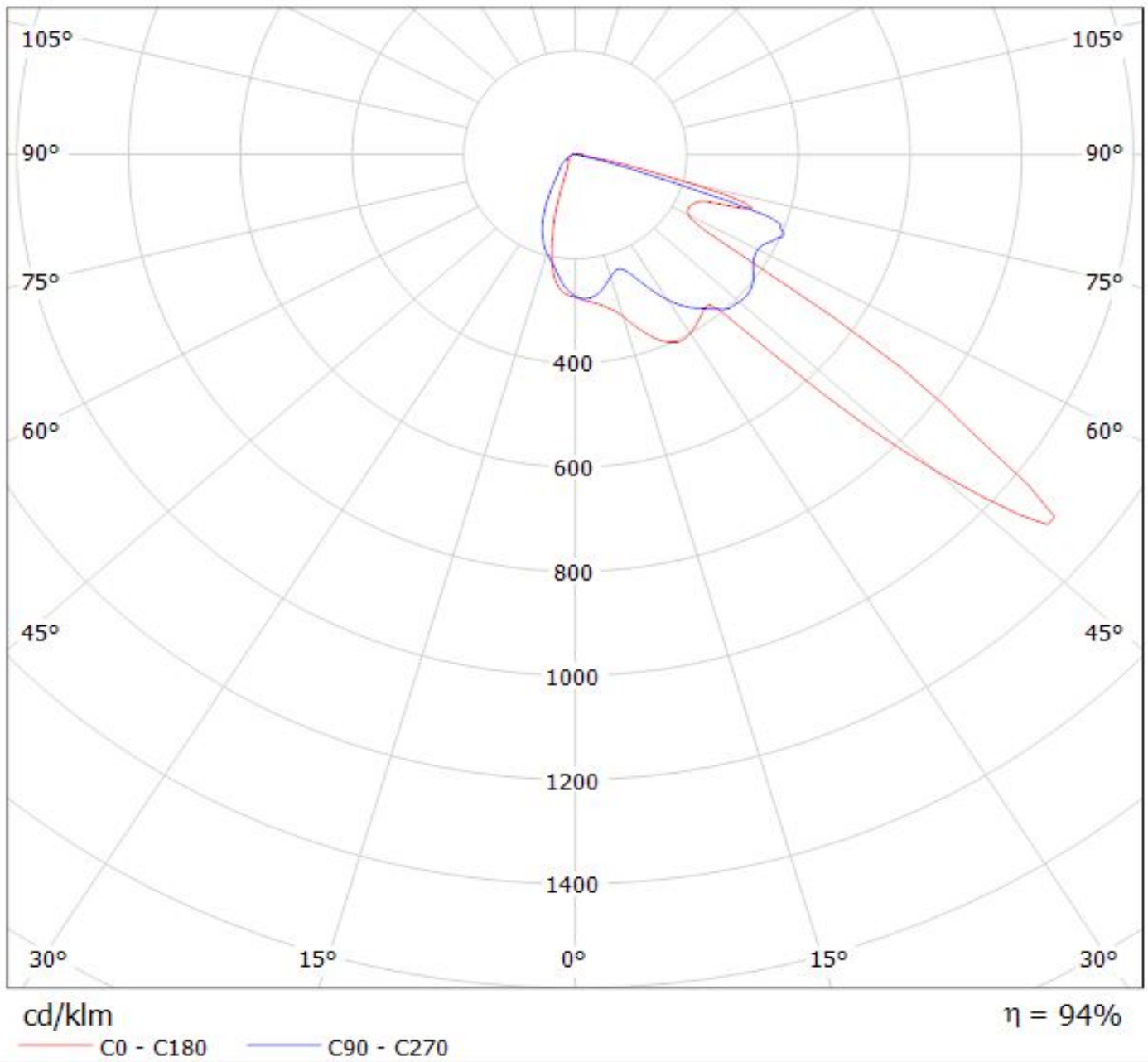

Luminaire: LEDiL Oy C14116\_STRADA-2X2-PX\_(Z5)

Lamps: 1 x SEOUL\_Z5\_(SZW05A0B)\_339.3lm@250mA\_P=3.01134W\_I=249.8mA

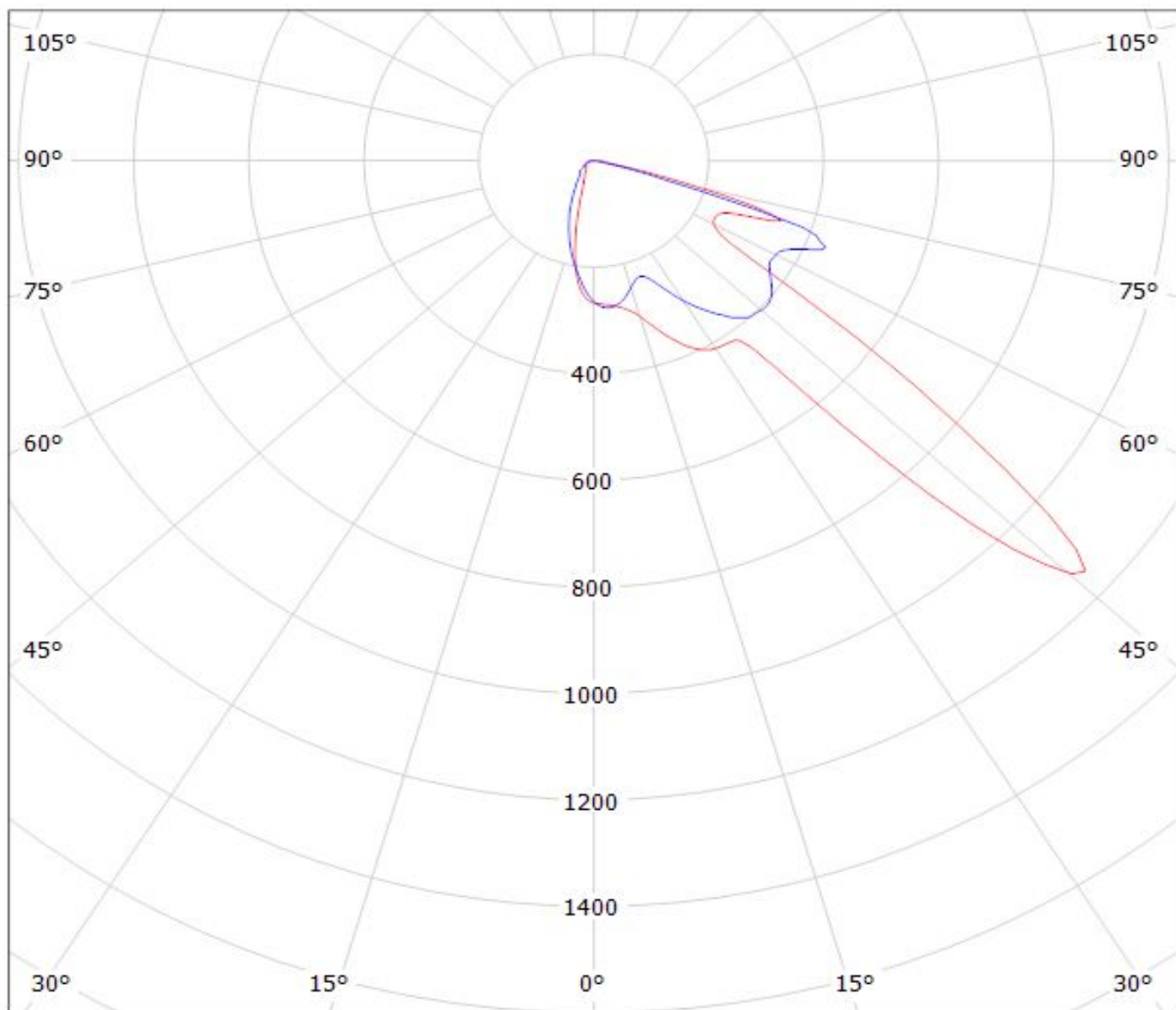

cd/klm

— C0 - C180

— C90 - C270

$\eta = 94\%$

Luminaire: LEDiL Oy C14116\_STRADA-2X2-PX\_(LH351A)

Lamps: 1 x Samsung\_LH351A\_2x2\_339.2lm@250mA\_P=3.20997W\_I=249.9mA

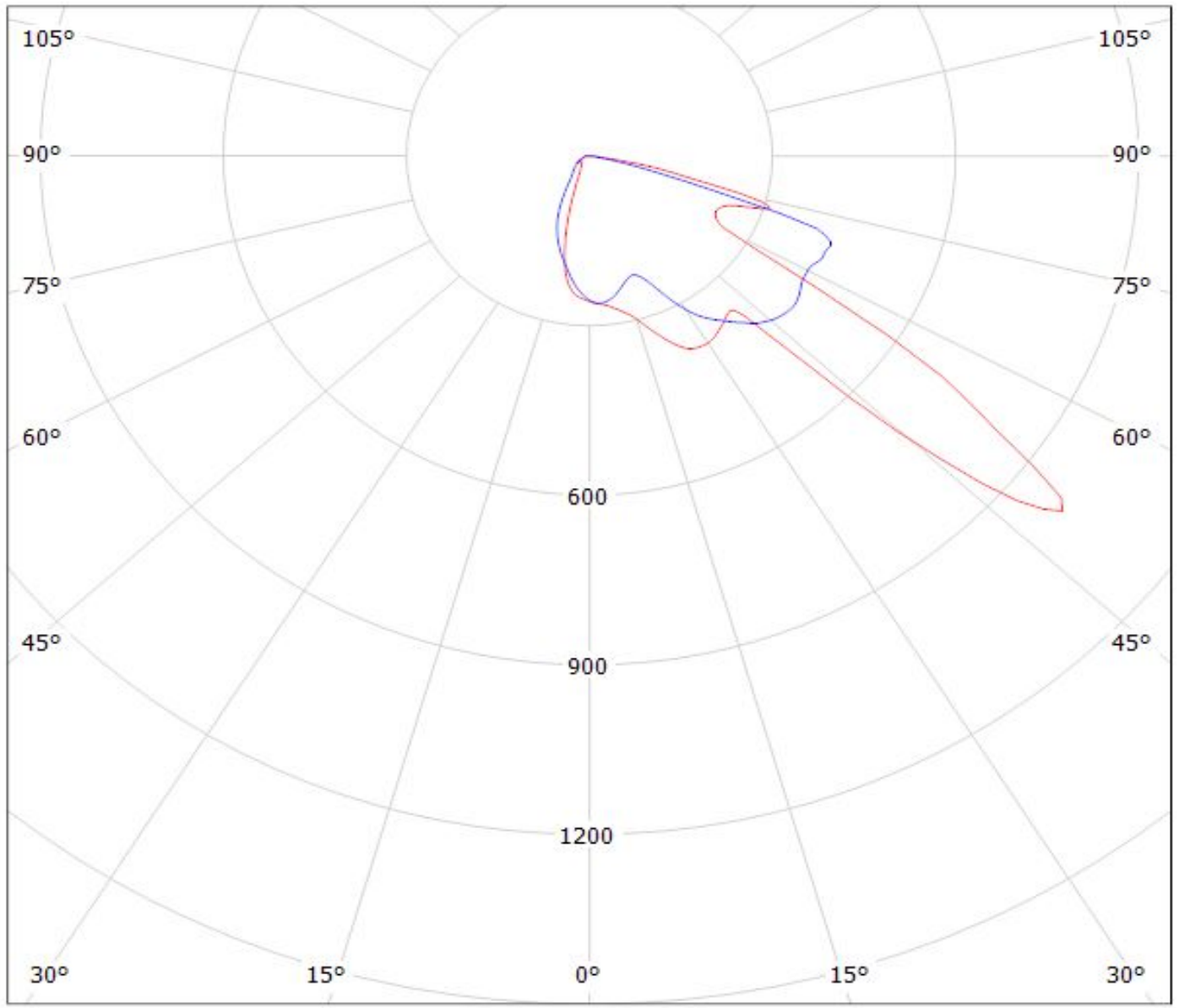

cd/klm

— C0 - C180    — C90 - C270

$\eta = 94\%$



Luminaire: LEDiL Oy C14116\_STRADA-2X2-PX\_(H35C0)

Lamps: 1 x LG\_H35C0\_2x2\_371.8lm@250mA\_P=2.94332W\_I=249.9mA

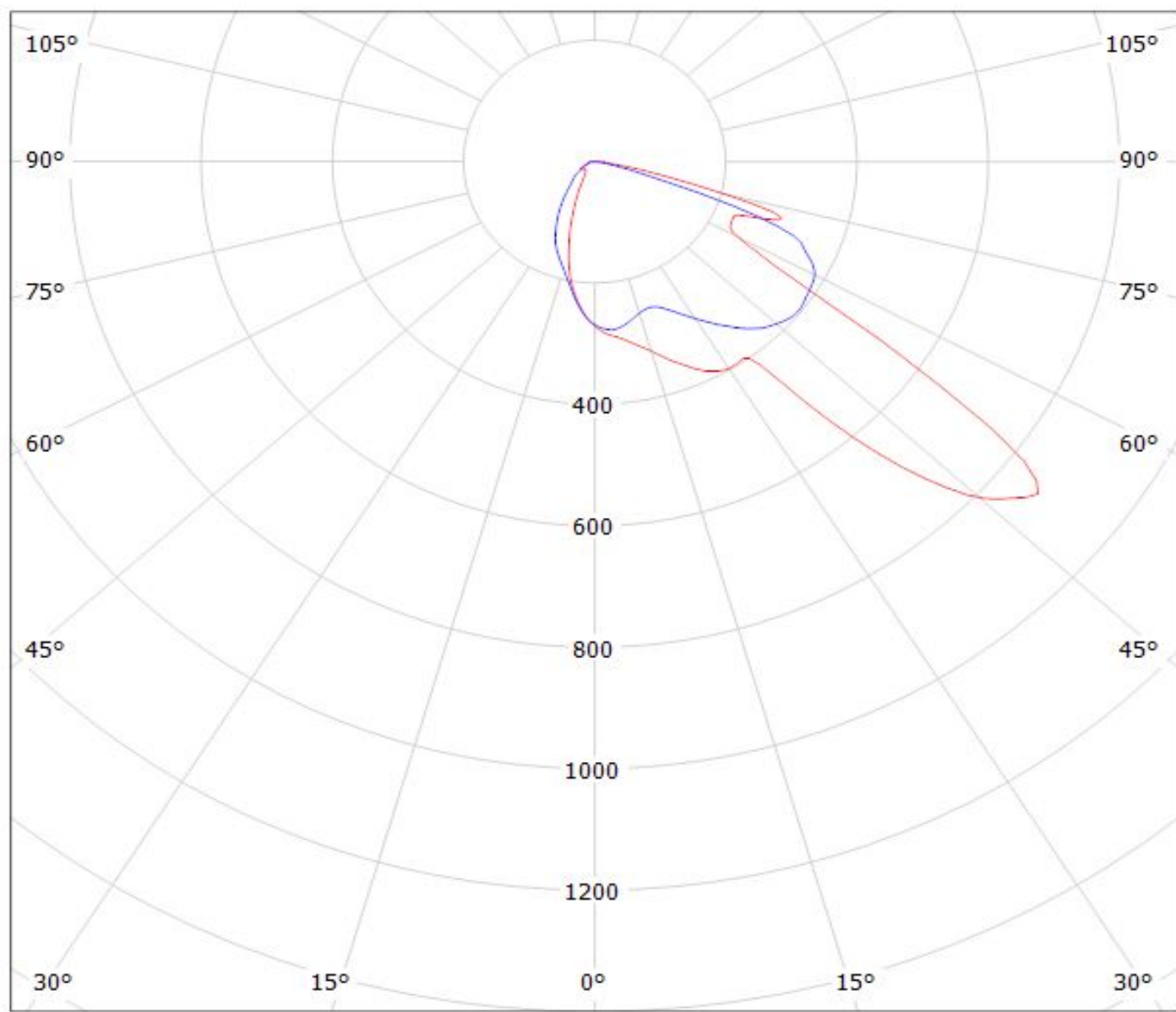

cd/klm

— C0 - C180

— C90 - C270

$\eta = 94\%$

Luminaire: LEDiL Oy C14116\_STRADA-2X2-PX\_(H35C1)

Lamps: 1 x LG\_H35C1\_2x2\_469.35lm@250mA\_P=2.86535W\_I=249.9mA

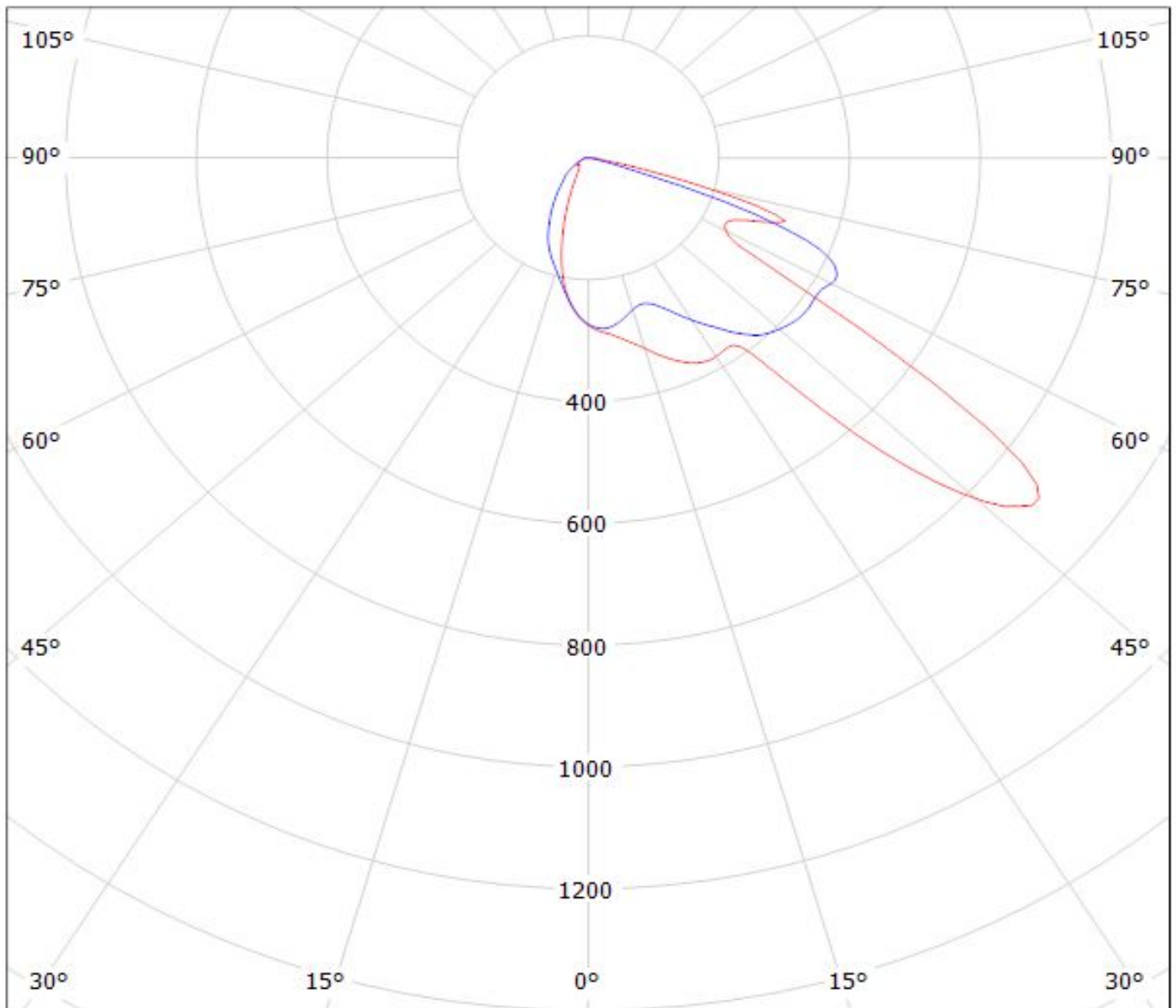

cd/klm

$\eta = 94\%$

— C0 - C180

— C90 - C270



Luminaire: LEDiL Oy C14116\_STRADA-2X2-PX\_(NS9x383)

Lamps: 1 x NICHIA\_NS9x383\_(NS9W383T)\_2x2\_380.85lm@250mA\_P=2.8856W\_I=249.9mA

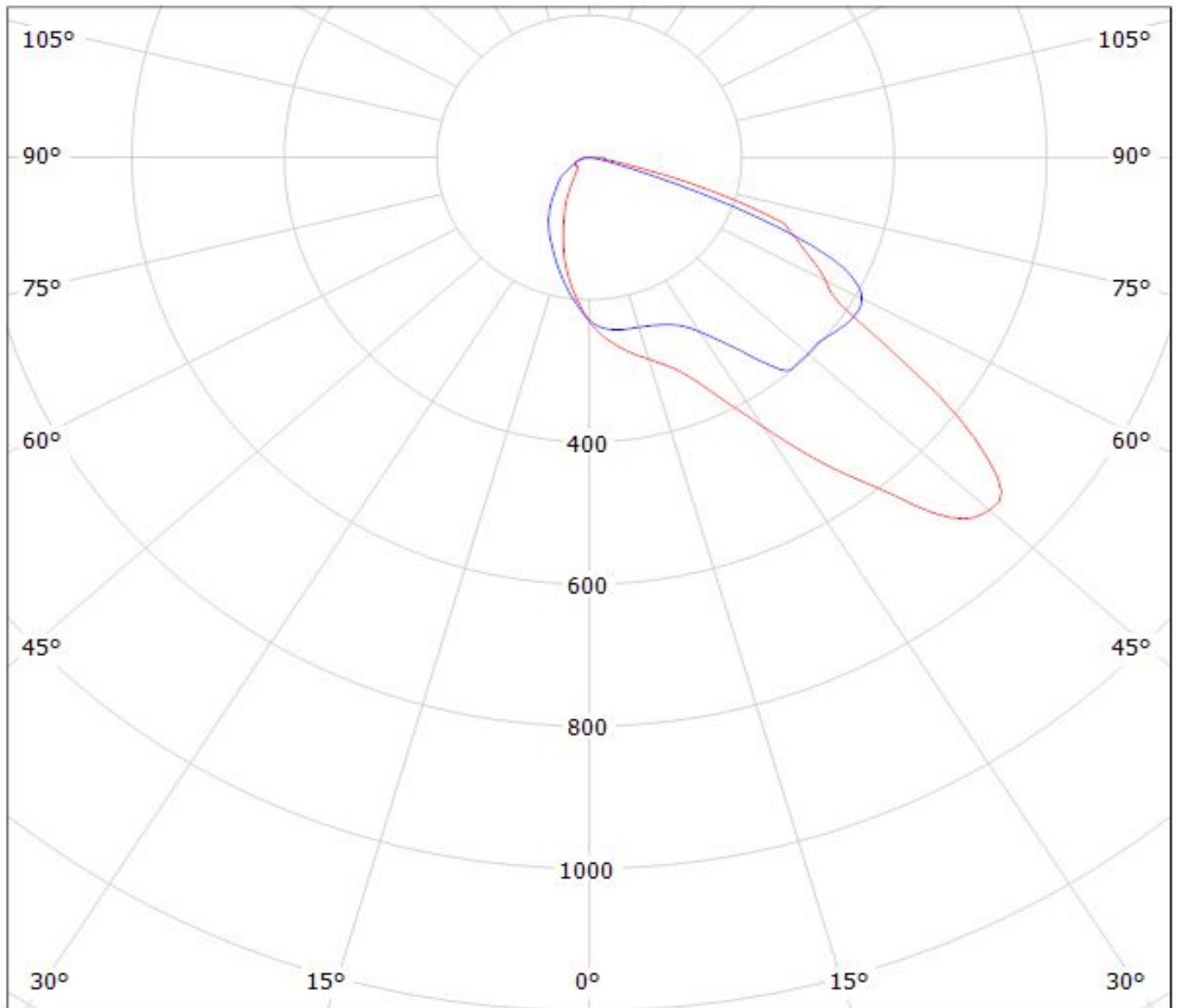

cd/klm

— C0 - C180

— C90 - C270

$\eta = 94\%$

Luminaire: LEDiL Oy C14116\_STRADA-2X2-PX\_(NVSxx19B)  
Lamps: 1 x NICHIA\_NVsxx19B\_(NVS219BE)  
\_2x2\_315lm@250mA\_CCT=3071K\_U=2.88235W\_I=249.9mA

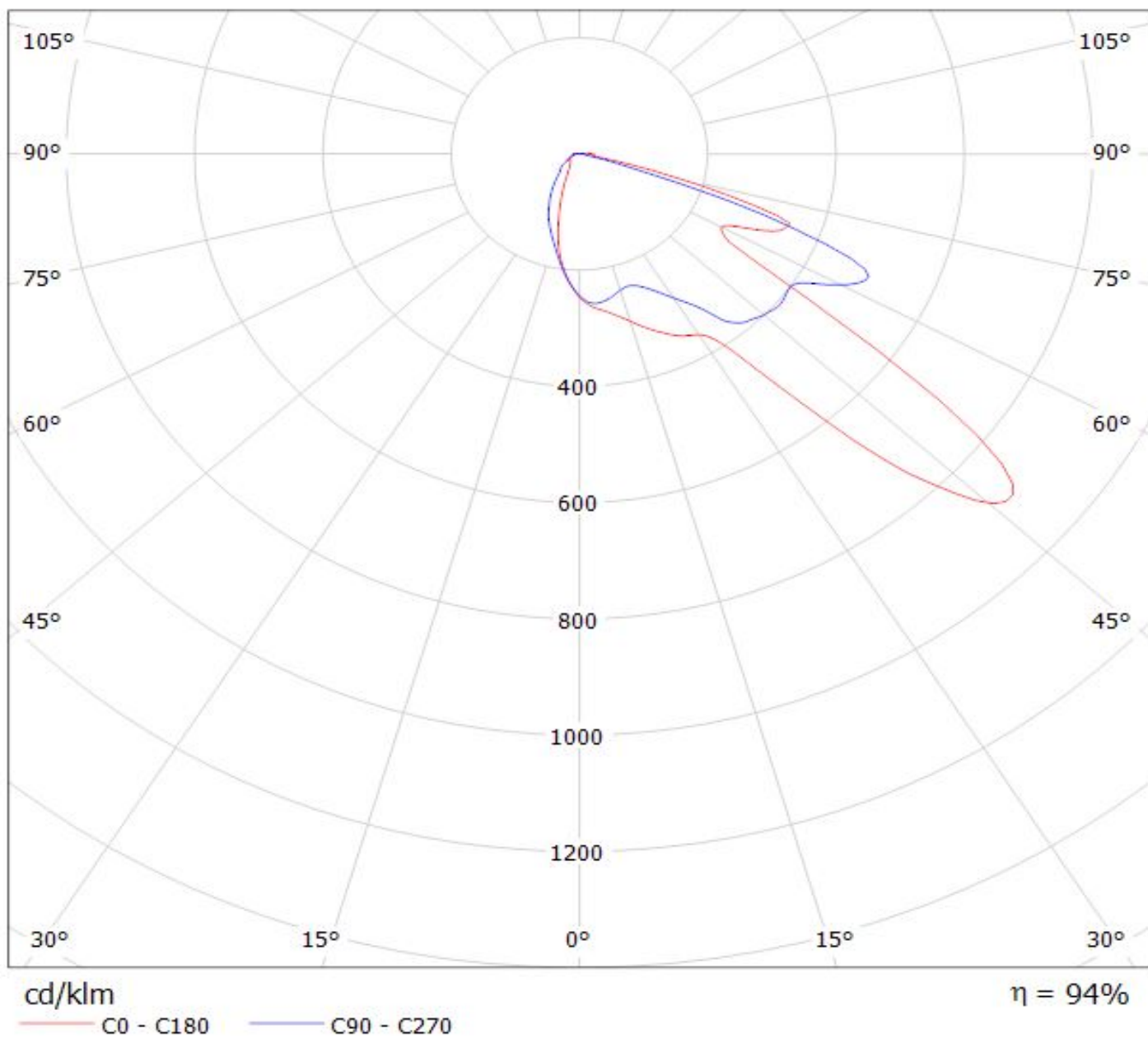

# Ledil C14116\_STRADA-2X2-PX\_(TL1L4) / LDC (Polar)

Luminaire: Ledil C14116\_STRADA-2X2-PX\_(TL1L4)

Lamps: 1 x Toshiba\_TL1L4\_2x2\_(TL1L4-DW0)\_472.639lm@250mA\_CCT=6500K\_P=2.9W\_I=0.25A

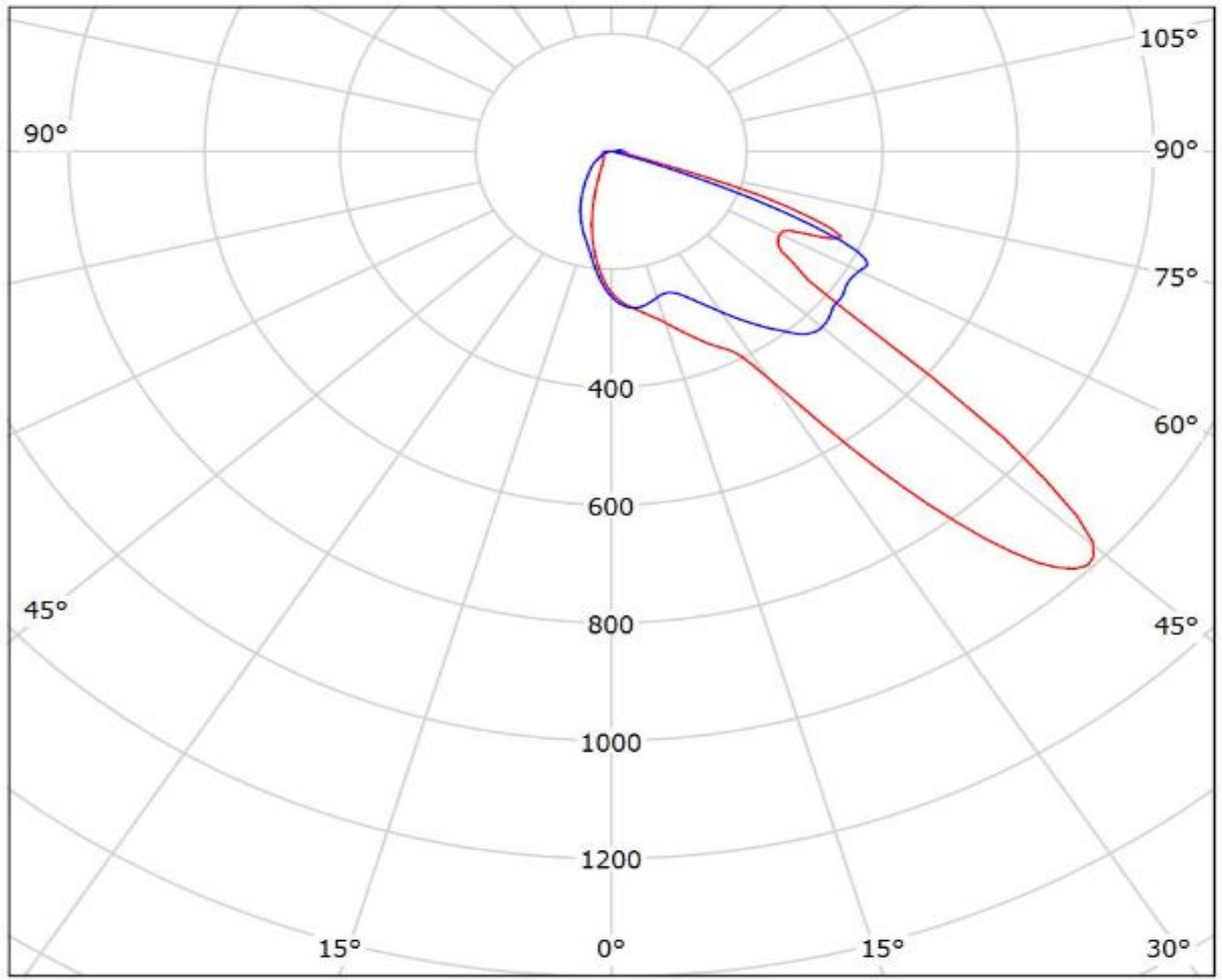

cd/klm

— C0 - C180    — C90 - C270

$\eta = 91\%$

Luminaire: LEDiL Oy C14116\_STRADA-2X2-PX\_(Fortimo\_F-Flex\_2x8\_740DAG3)  
Lamps: 1 x Philips\_Fortimo\_F-Flex\_2x8\_740DAG3\_1780.2lm@250mA\_P=11.6112W\_I=0.2498A

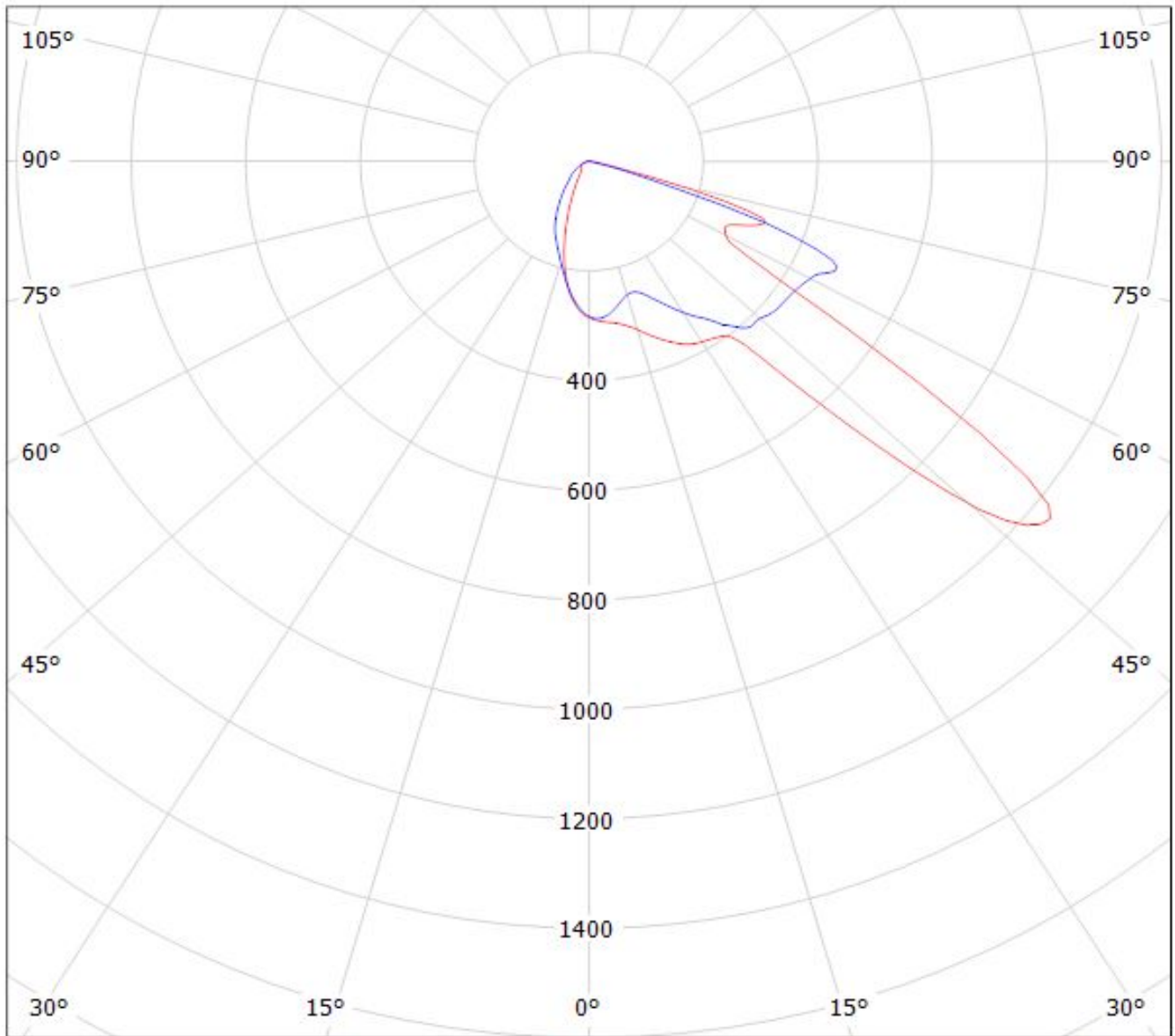

cd/klm

$\eta = 96\%$

— C0 - C180    — C90 - C270

Luminaire: LEDiL Oy C14116\_STRADA-2x2-PX\_(Z5M1)  
Lamps: 1 x SEOUL\_Z5M1\_2x2\_(SZ5-M1-WN-C8)  
\_391.15lm@250mA\_CCT=4587K\_P=2.86086W\_I=249.9mA

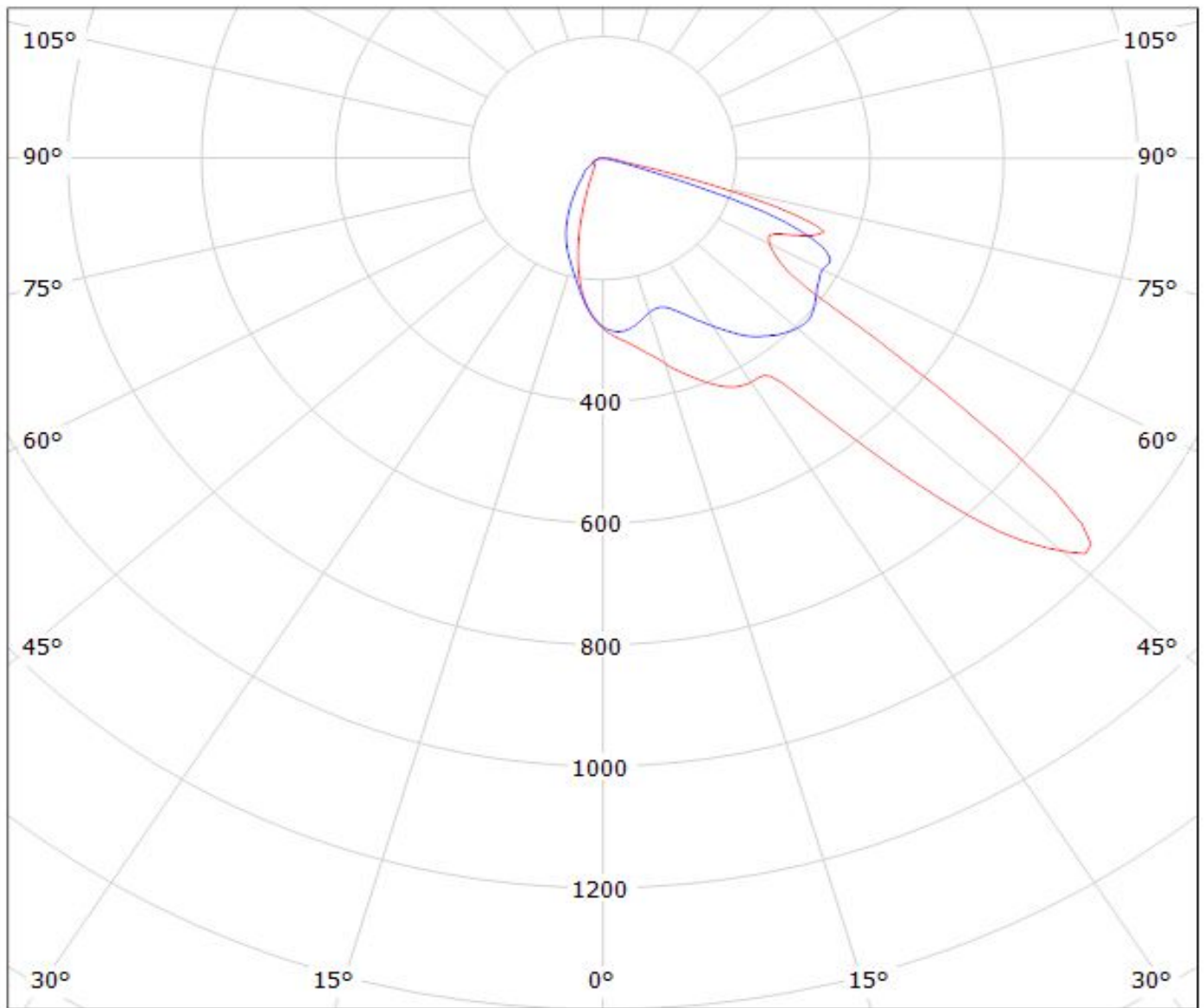

cd/klm

— C0 - C180    — C90 - C270

$\eta = 94\%$

Luminaire: LEDiL Oy C14116\_STRADA-2x2-PX\_(Z5M)

Lamps: 1 x SEOUL\_Z5M\_2x2\_(SZ5-M0-W0-00)\_366.55lm@250mA\_P=2.96931W\_I=249.9mA

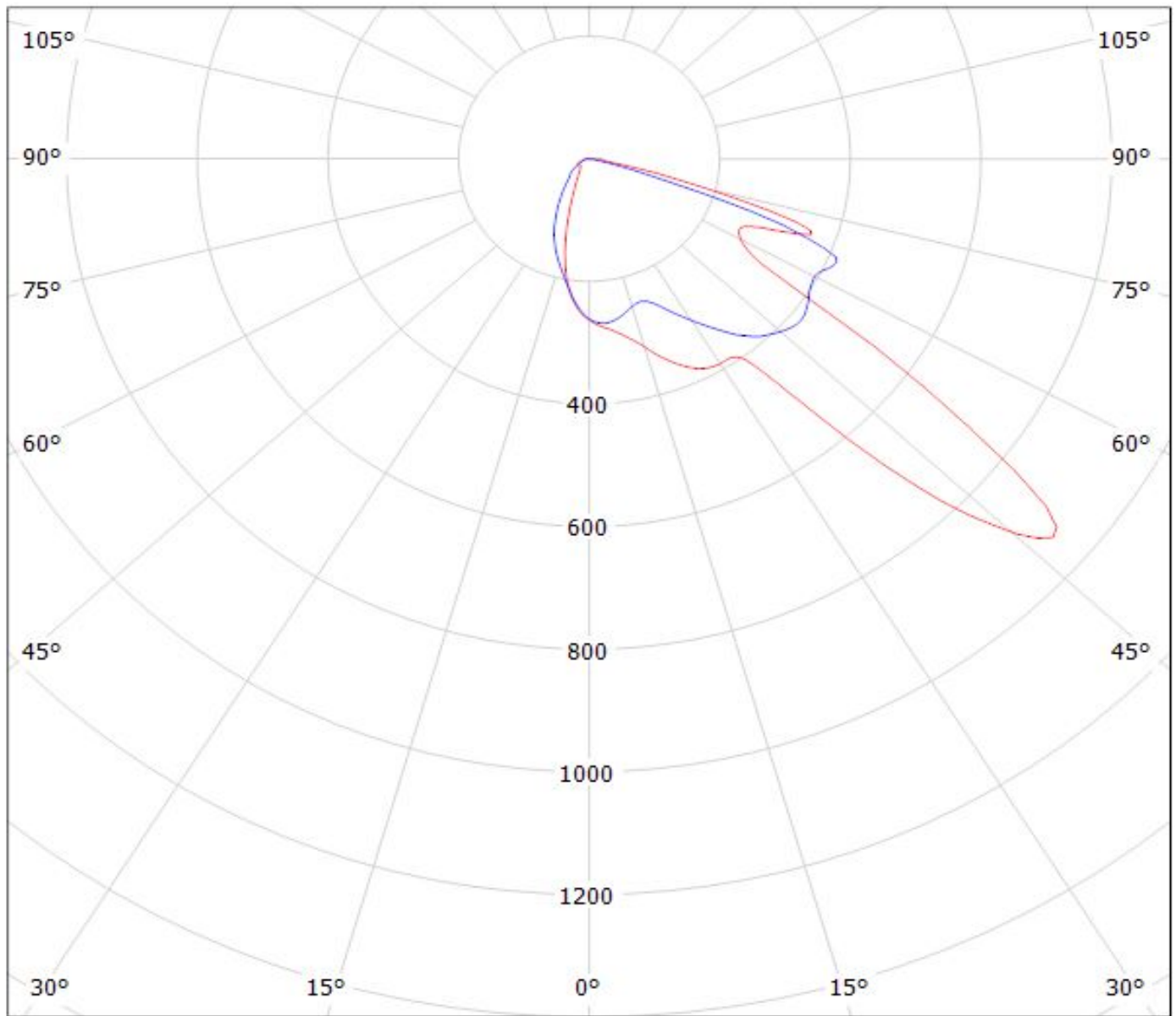

cd/klm

— C0 - C180

— C90 - C270

$\eta = 94\%$



Luminaire: LEDiL Oy C14116\_STRADA-2x2-PX\_(LH351Z)

Lamps: 1 x SAMSUNG\_LH351Z\_2x2\_(SZ5-M0-W0-00)\_363.65lm@250mA\_P=2.86635W\_I=249.9mA

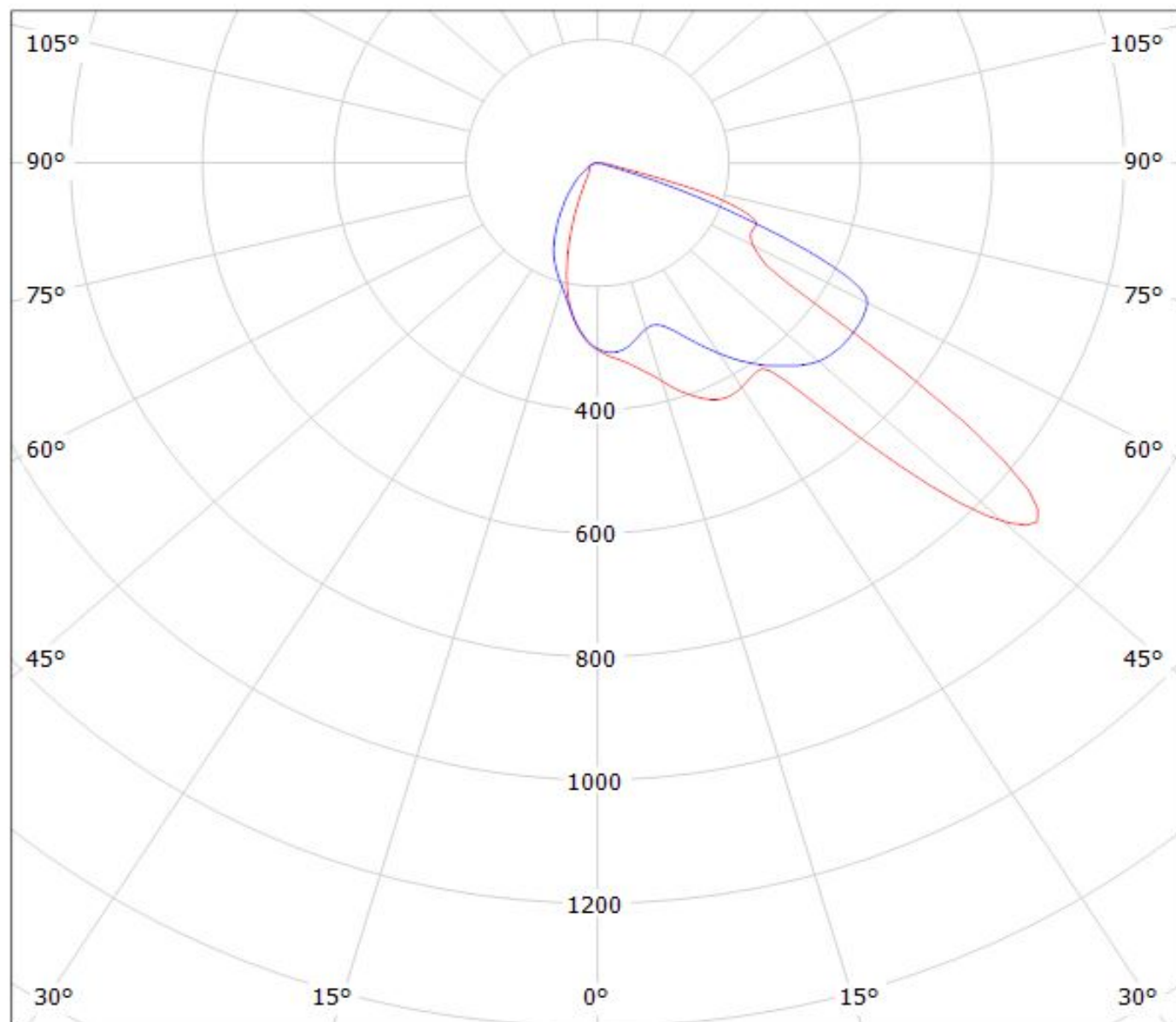

cd/klm

— C0 - C180

— C90 - C270

$\eta = 94\%$

Luminaire: LEDiL Oy C14116\_STRADA-2x2-PX\_(ACRICH\_MJT\_4040)  
Lamps: 1 x SEOUL\_ACRICH\_MJT\_4040\_2x2\_(SAW09H0A)  
\_131.93lm@250mA\_P=1.12281W\_I=19.5mA

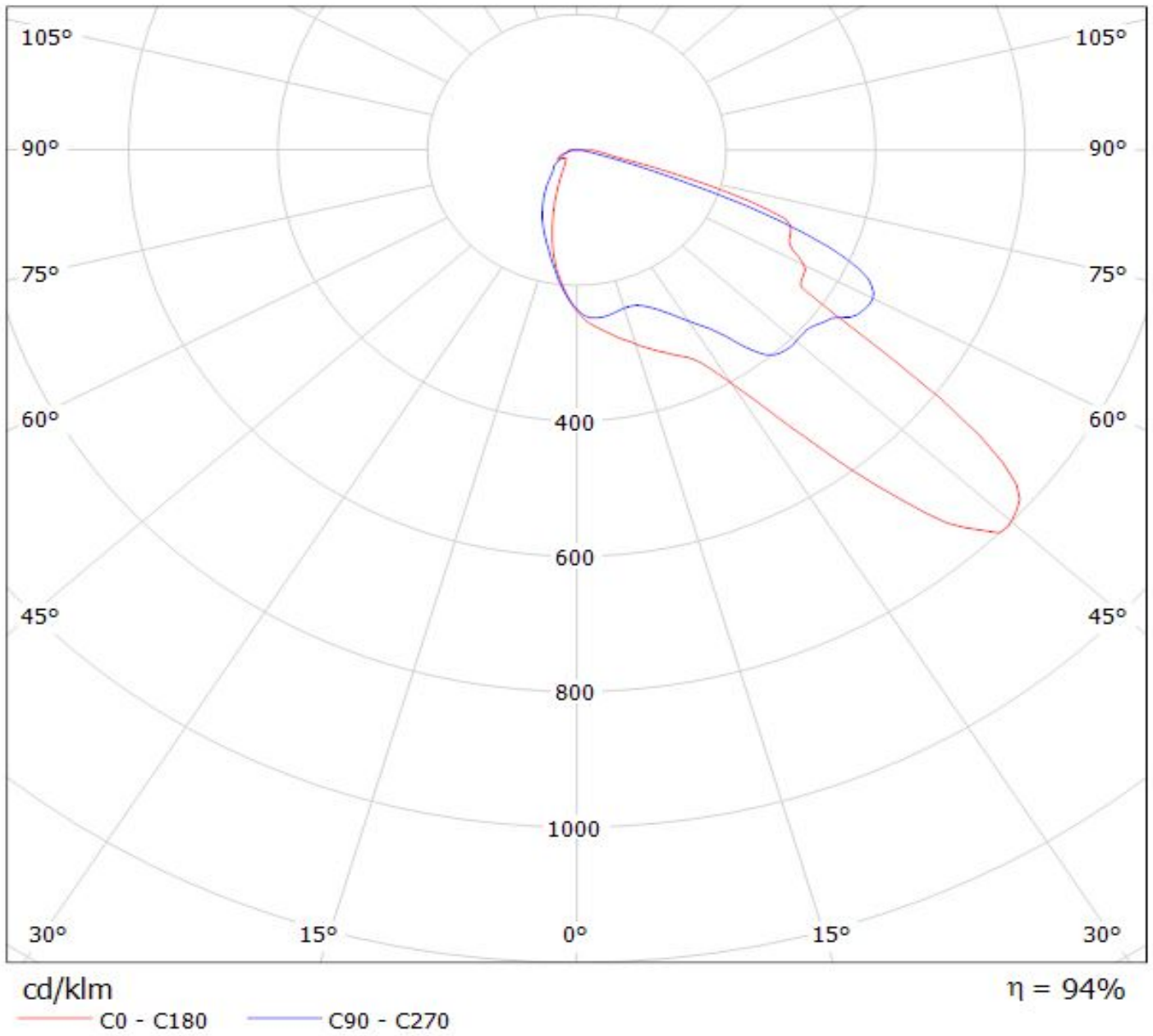



Luminaire: LEDiL Oy C14116\_STRADA-2X2-PX\_(XP-E2)

Lamps: 1 x CREE\_XP-E2\_2x2\_(XPEBWT-L1-7B4-Q4-0-01)\_340.5lm@250mA\_P=2.93108W\_I=249.9mA

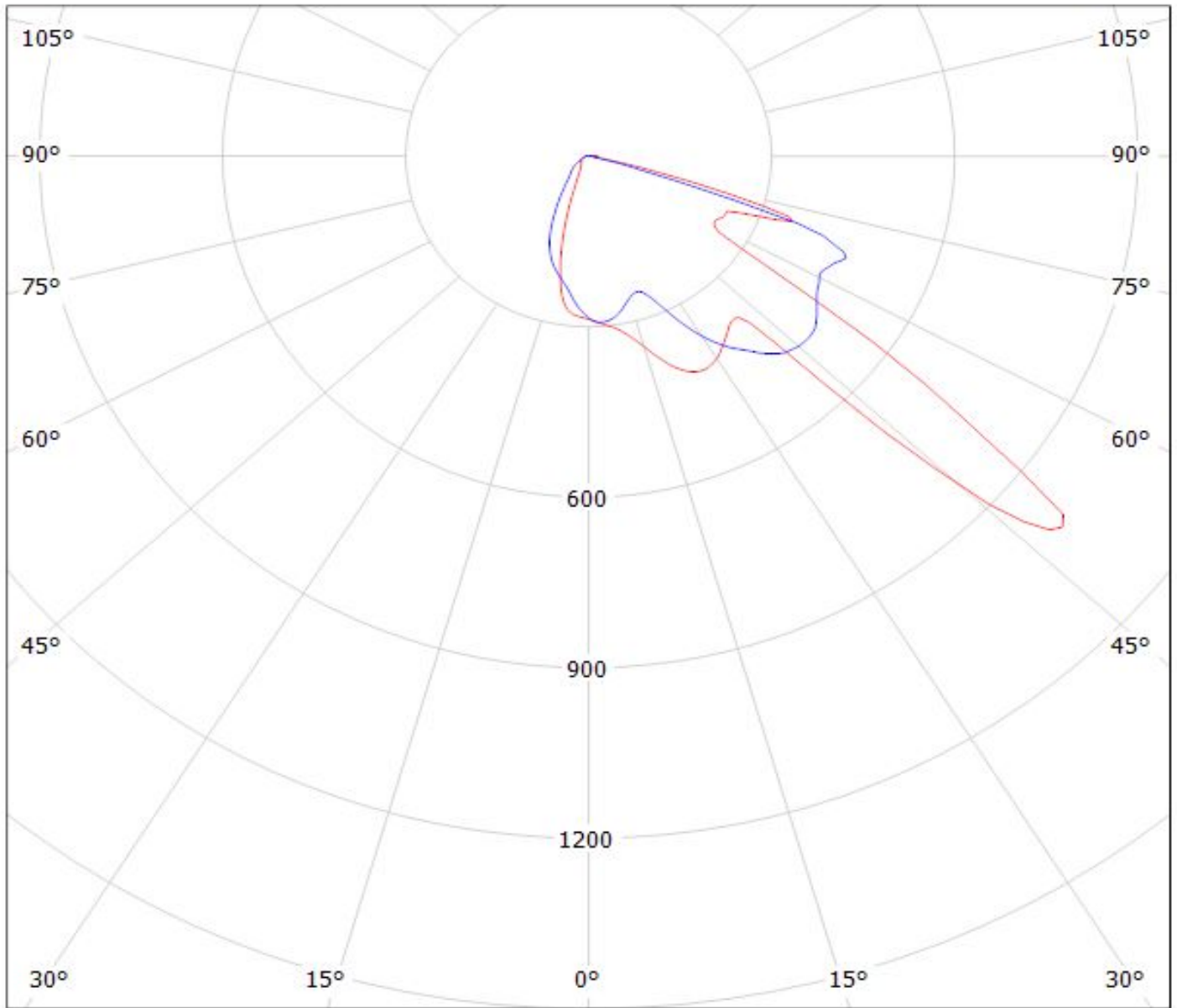

cd/klm

$\eta = 94\%$

— C0 - C180

— C90 - C270

Luminaire: LEDiL Oy C14116\_STRADA-2X2-PX\_(XP-G)

Lamps: 1 x CREE\_XP-G\_2x2\_259.15lm@250mA\_P=2.90609W\_I=249.9mA

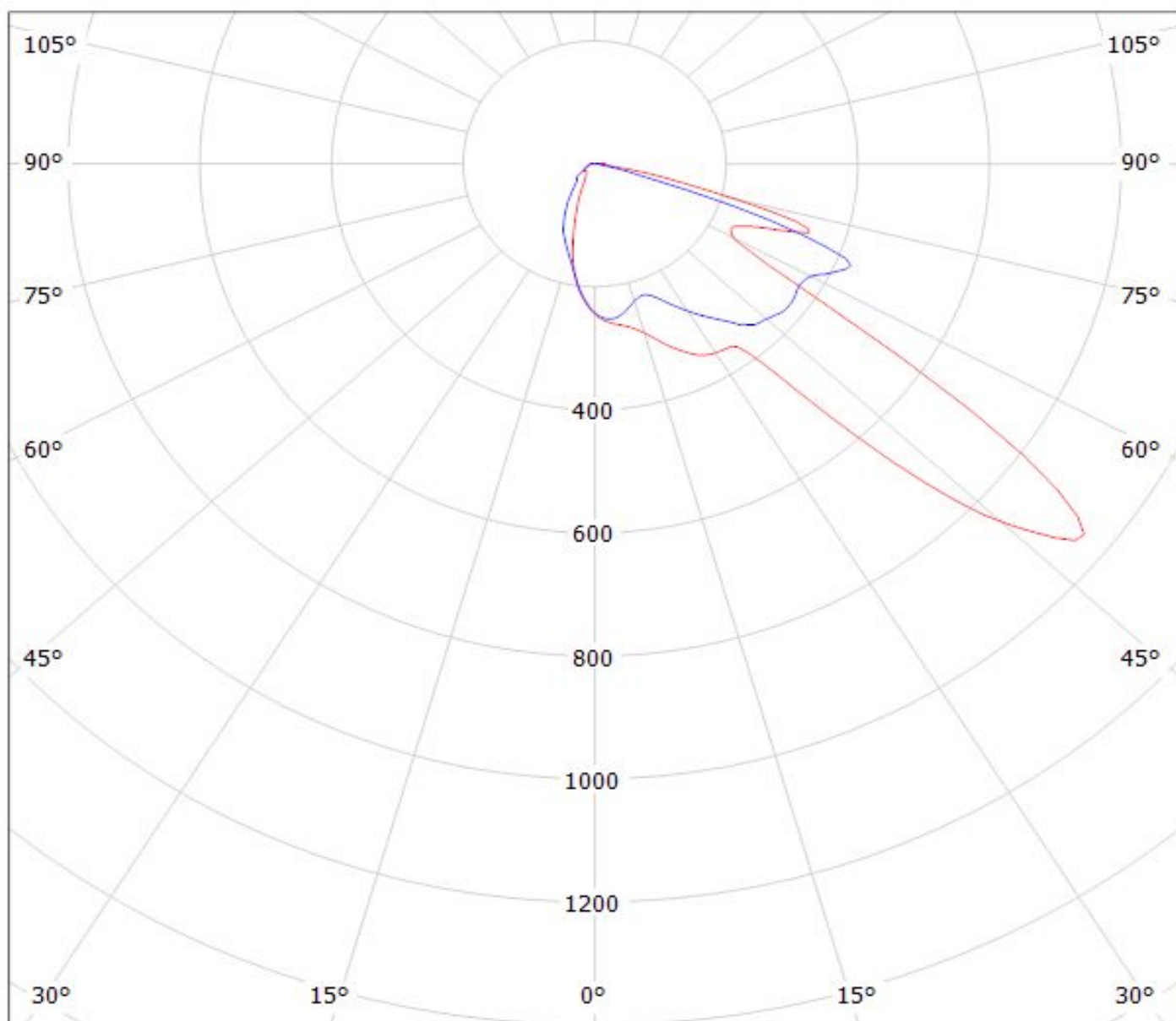

cd/klm

— C0 - C180

— C90 - C270

$\eta = 94\%$

Luminaire: LEDiL Oy C14116\_STRADA-2X2-PX\_(XB-H)  
Lamps: 1 x Cree\_XB-H\_2x2\_(XBHAWT-0-5A3-T50-0L-0001)  
\_442.65lm@250mA\_P=2.96762W\_I=249.8mA

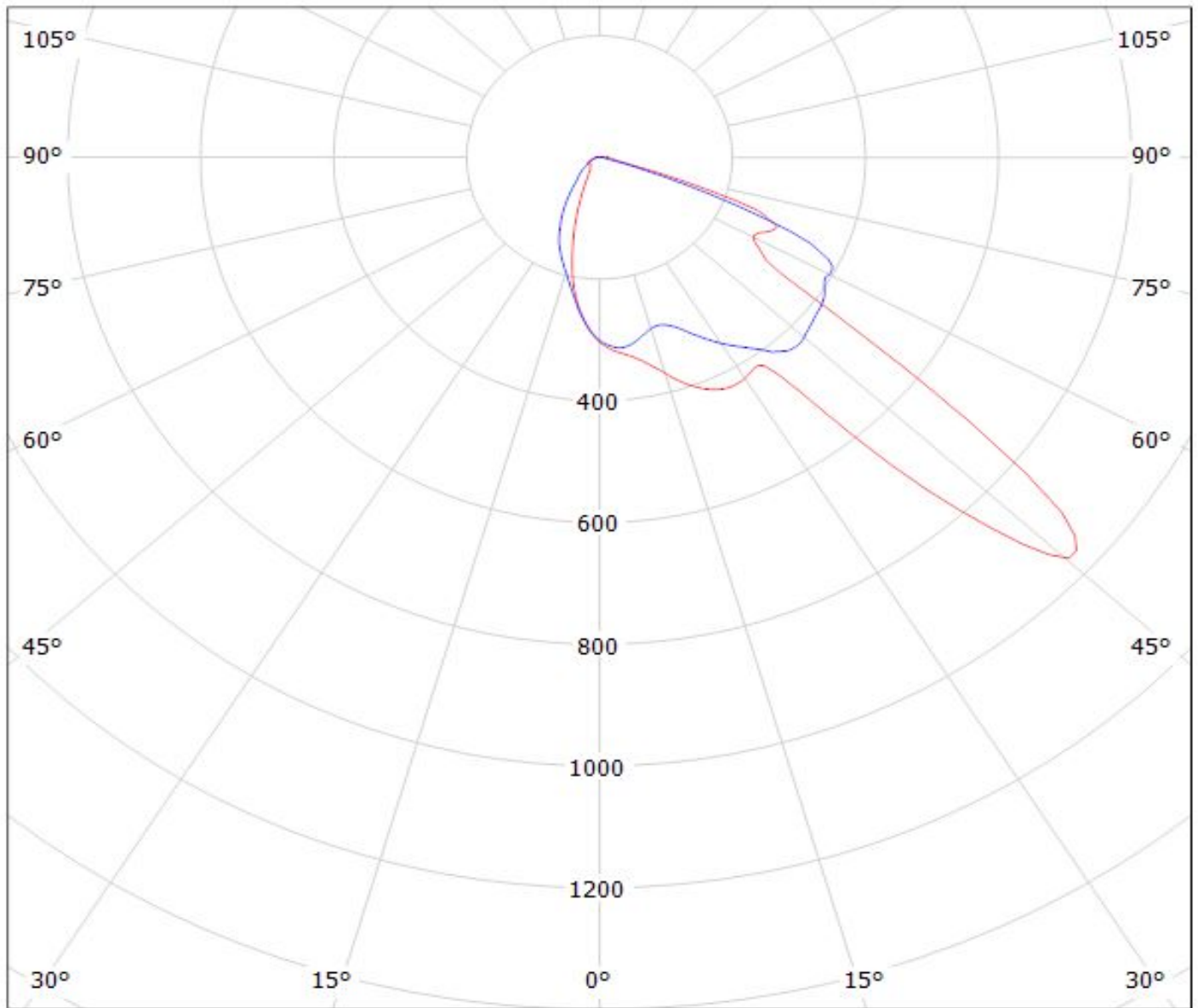

cd/klm

$\eta = 94\%$

— C0 - C180    — C90 - C270

Luminaire: LEDiL Oy C14116\_STRADA-2X2-PX\_(XP-L)  
Lamps: 1 x CREE\_XP-L\_2x2\_(XPLAWT-0-1B0-V40-00-0001)  
\_508.5lm@250mA\_CCT=7600K\_P=2.80563W\_I=249.9mA

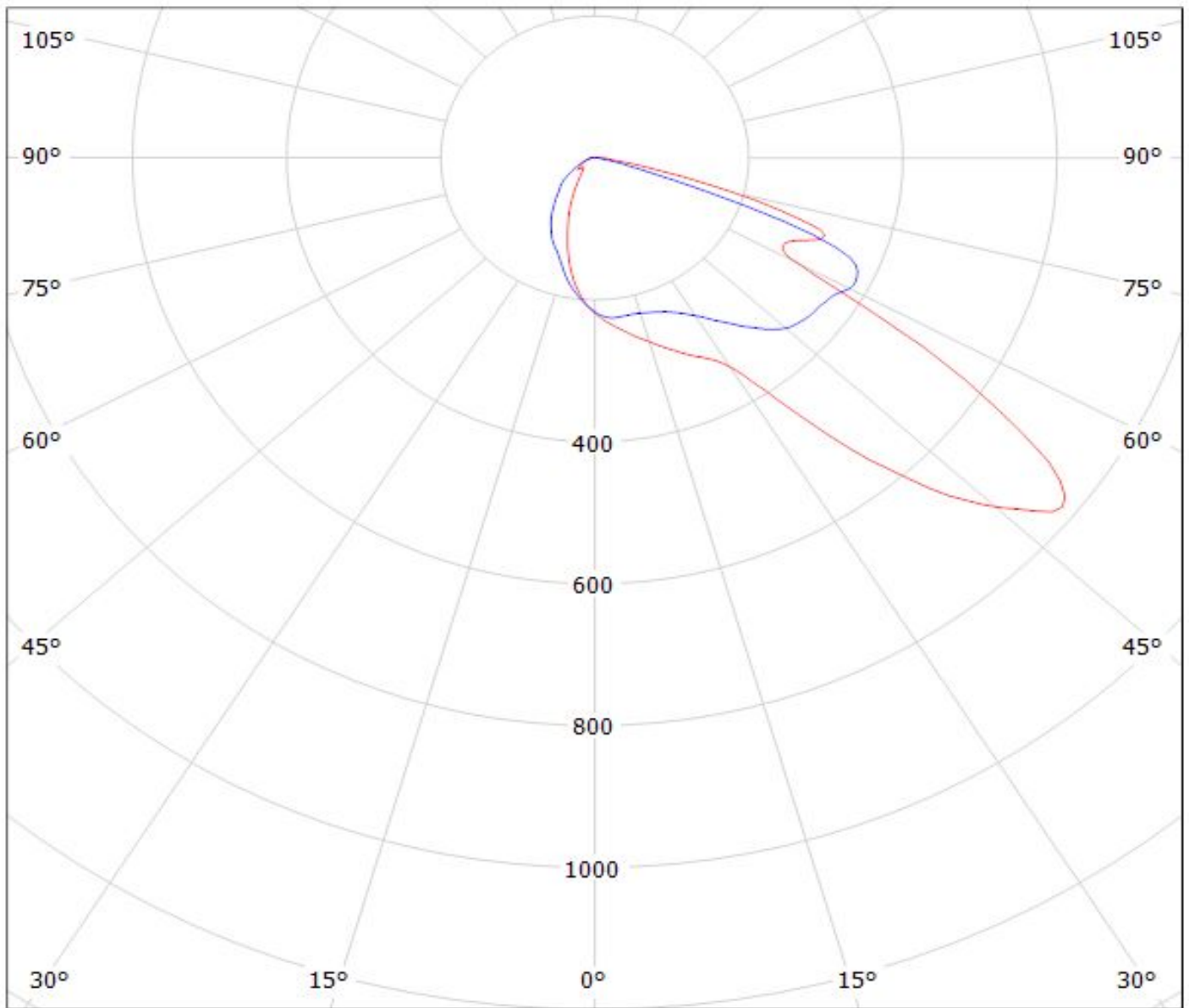

cd/klm

$\eta = 94\%$

— C0 - C180    — C90 - C270

Luminaire: LEDiL Oy C14116\_STRADA-2X2-PX\_(LUXEON\_R)

Lamps: 1 x LUXEON\_R\_2x2\_(LXA7-PW30)\_314.95lm@250mA\_P=2.78414W\_I=249.9mA

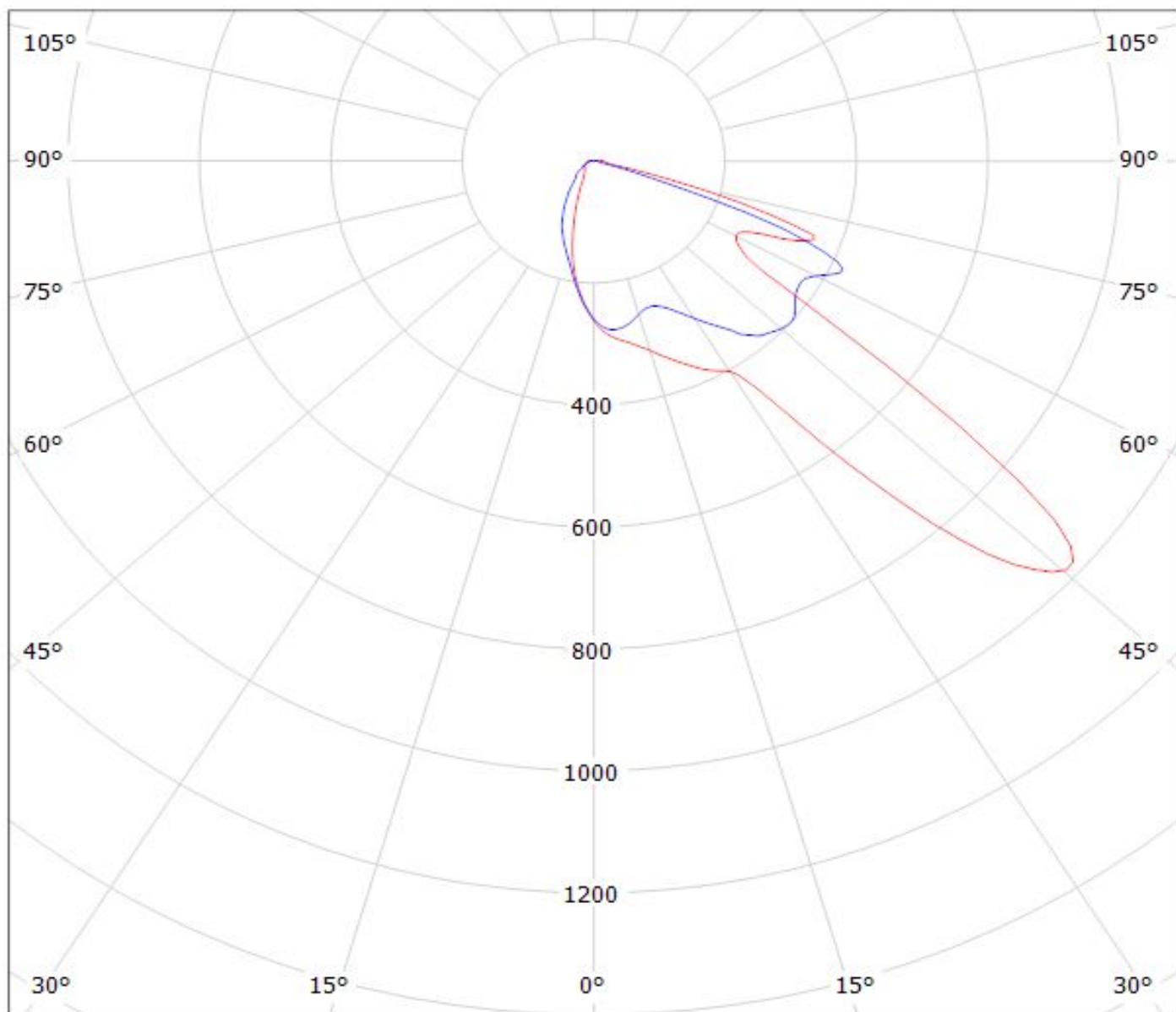

cd/klm

— C0 - C180

— C90 - C270

$\eta = 94\%$

Luminaire: LEDiL Oy C14116\_STRADA-2X2-PX\_(Z\_ES)

Lamps: 1 x Luxeon\_Z\_ES\_2x2\_(LXZ2-3090)\_214.14lm@250mA\_P=2.82437W\_I=249.9mA

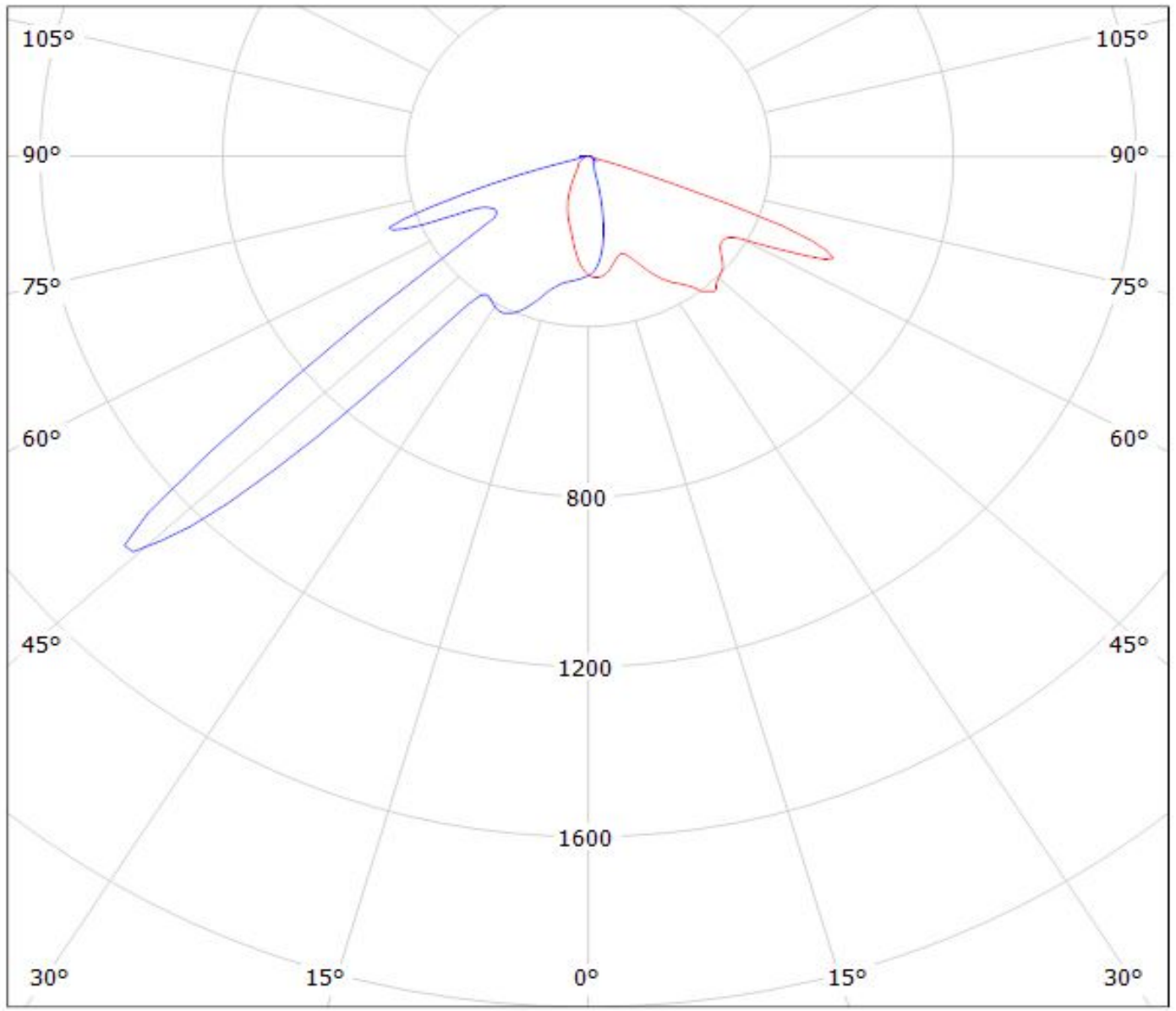

cd/klm

— C0 - C180    — C90 - C270

$\eta = 94\%$



Luminaire: LEDiL Oy C14116\_STRADA-2X2-PX\_(NCSxx19A)  
Lamps: 1 x Nichia\_NCSxx19A\_(NCS119AT-H1)  
\_234.37lm@250mA\_CCT=2830K\_P=3.07452W\_I=249.9mA

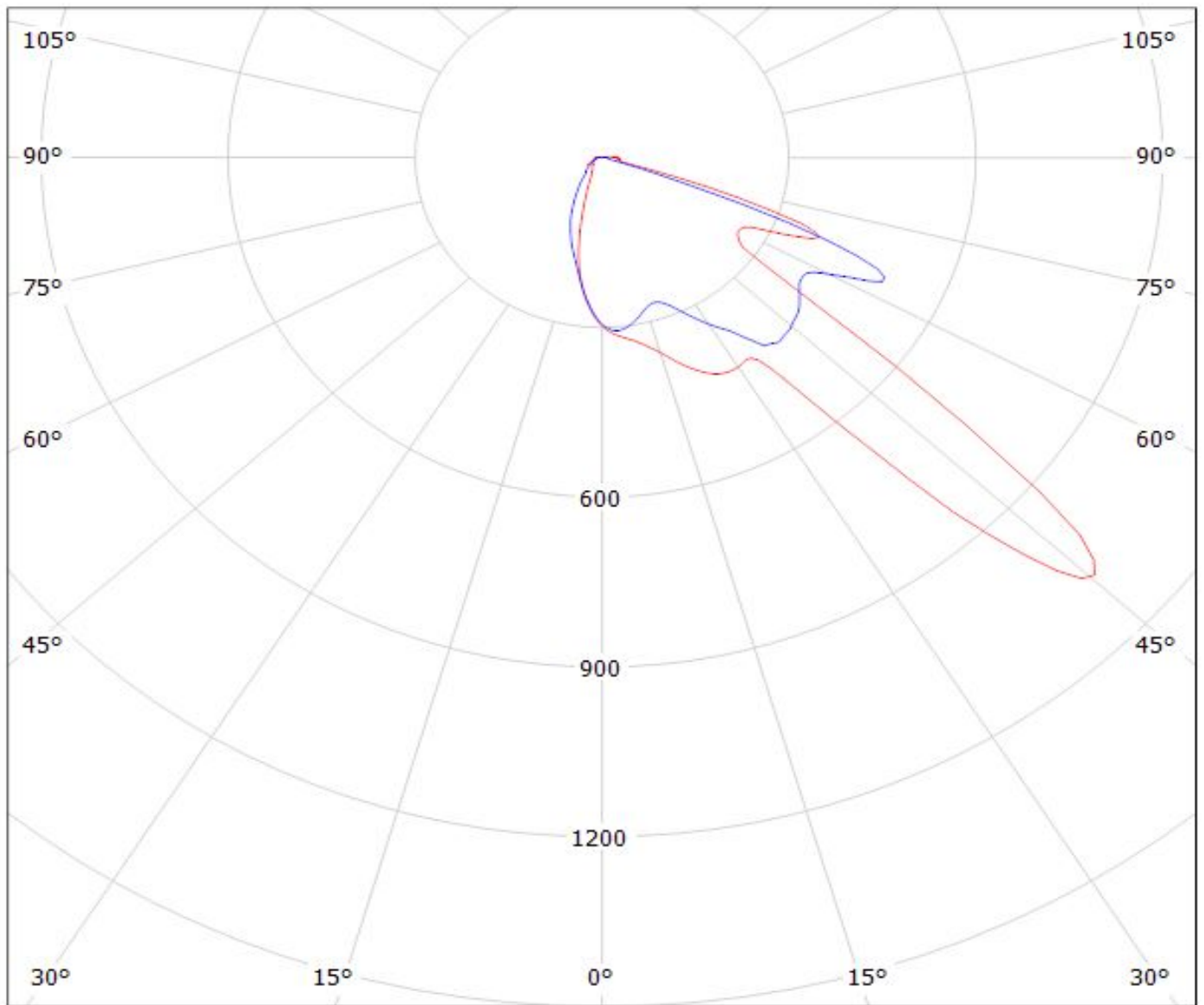

cd/klm

— C0 - C180 — C90 - C270

$\eta = 94\%$



Luminaire: LEDiL Oy C14116\_STRADA-2X2-PX\_(NVSxx19A)

Lamps: 1 x Nichia\_NVsxx19A\_(NVS219AT)\_392.14lm@250mA\_P=2.91991W\_I=249.8mA

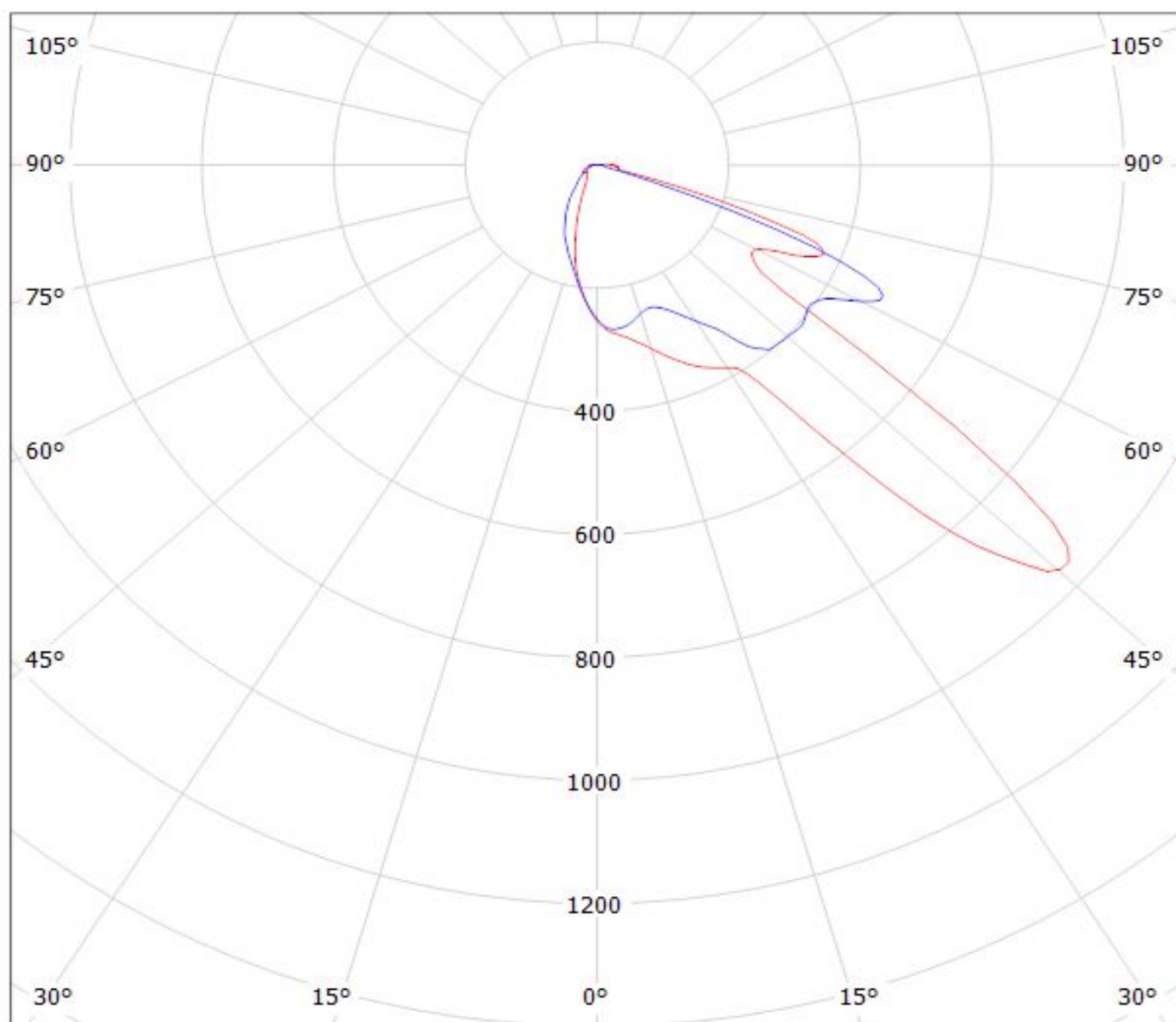

cd/klm

— C0 - C180

— C90 - C270

$\eta = 94\%$

Luminaire: LEDiL Oy C14116\_STRADA-2X2-PX\_(LUXEON\_Q)

Lamps: 1 x LUXEON\_Q\_2x2\_(LHQ-3080)\_306.14lm@250mA\_P=2.88419W\_I=249.8mA

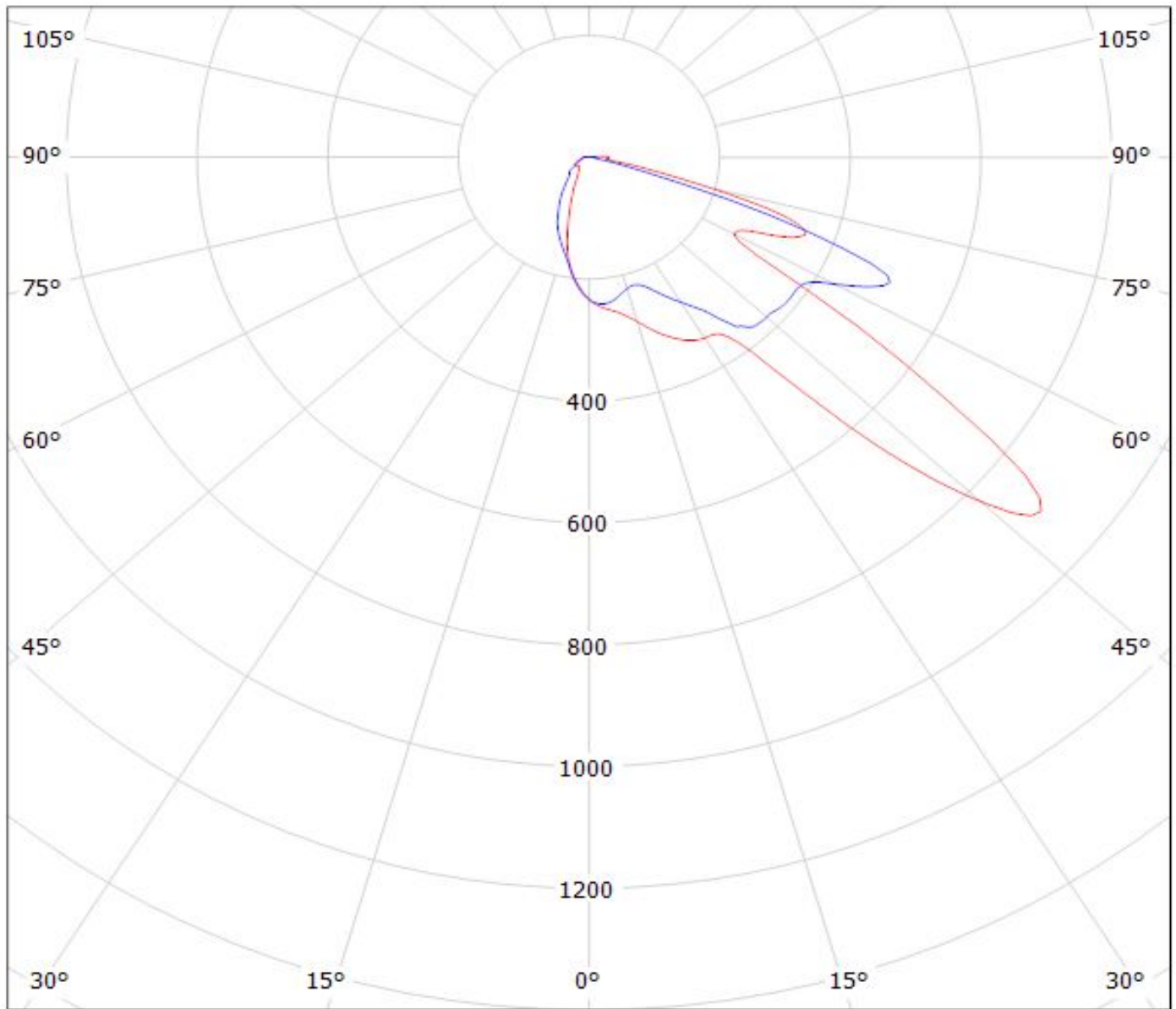

cd/klm

— C0 - C180

— C90 - C270

$\eta = 94\%$

Luminaire: LEDiL Oy C14116\_STRADA-2X2-PX\_(LUXEON\_TX)

Lamps: 1 x LUXEON\_TX\_2x2\_(L1T2-3585)\_327.05lm@250mA\_P=2.79476W\_I=249.8mA

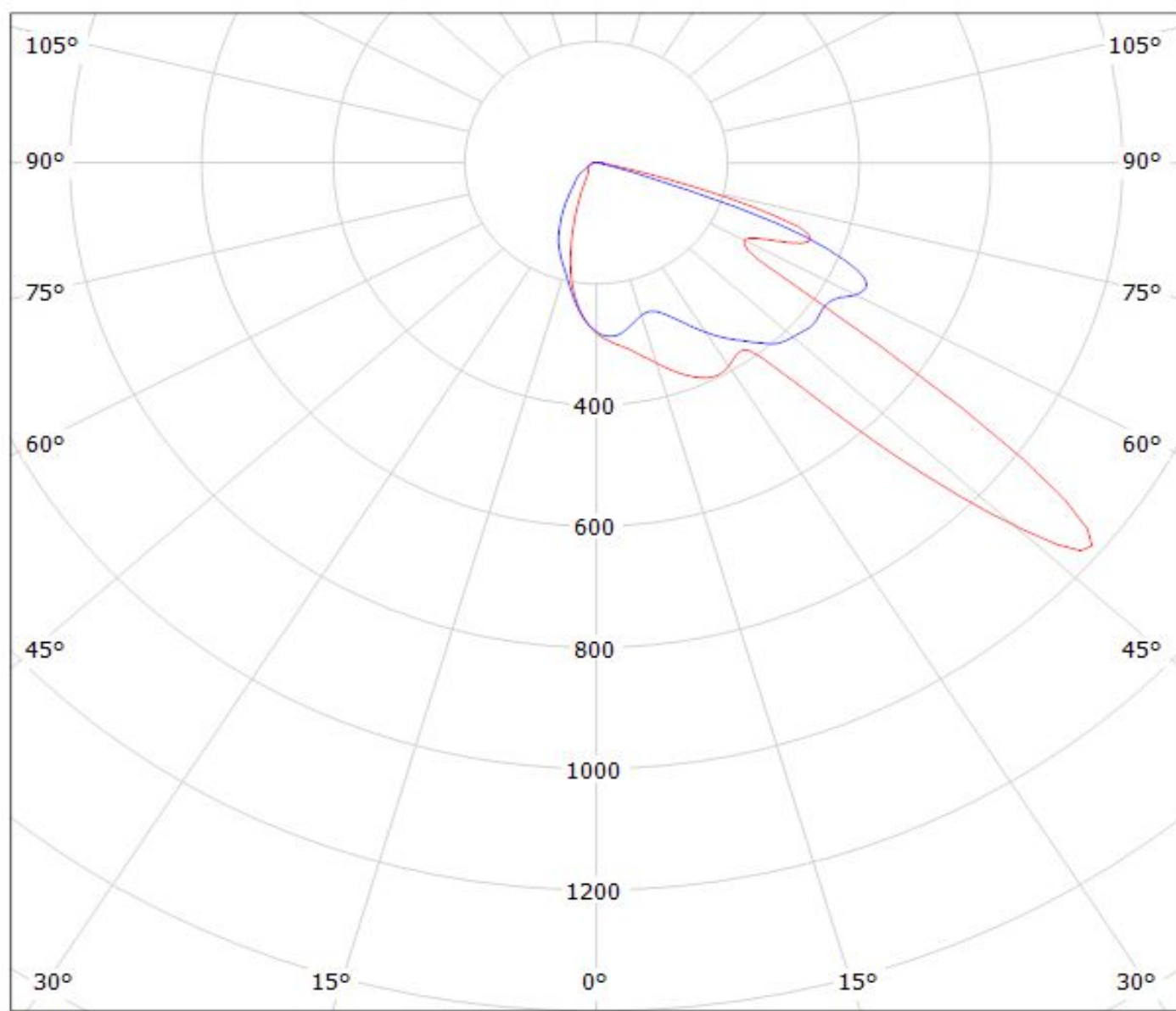

cd/klm

— C0 - C180

— C90 - C270

$\eta = 94\%$

**NOTE: The typical divergence will be changed by different color, chip size and chip position tolerance. The typical total divergence is the full angle measured where the luminous intensity is half of the peak value.**

## X-ON Electronics

Largest Supplier of Electrical and Electronic Components

*Click to view similar products for [LED Lighting Lenses](#) category:*

*Click to view products by [Ledil](#) manufacturer:*

Other Similar products are found below :

[LL01ED-AK40L06](#) [LL01ZZ-EX25L06-M2](#) [180182-0000](#) [FNP-N2-N083-0R NRW](#) [LL01ED-ALI55R49](#) [0190535300](#) [0410111300](#)  
[0510113303](#) [0530997](#) [2710121](#) [C11004\\_TINA2-RS](#) [C12231\\_LENA-FRESNEL-LENS](#) [LL01ED-AKY24R49](#) [LL01CR-AYG15R49](#)  
[LL01CR-OT32L06-M2](#) [LL01ZZ-AAA24L49](#) [LL01CR-CEN38L02](#) [LL01ZZ-AAA55L49](#) [LL01CR-AYG24R49](#) [LL01A00CZMB2-M2](#)  
[LL01ED-AKY38R49](#) [LL01CR-CNE2545L06-M2](#) [LL01ZZ-AAA38L49](#) [LL01ED-AKV36R49](#) [LL01ED-ALI24R49](#) [LL01CR-AYG38R49](#)  
[FN15973\\_RONDA-REC-60-C](#) [FP-MS-11.5](#) [F16859\\_LINDA-ZT25](#) [C14169\\_LENA-CLEAR-LENS](#) [C16125\\_OLGA-W](#) [C17410\\_SPORT-](#)  
[2X2-FT6](#) [C17414\\_SPORT-2X2-S6](#) [C17409\\_SPORT-2X2-FT6W](#) [C17360\\_SPORT-2X2-FT60](#) [C17434\\_ILONA-WW](#) [F16636\\_LINDA-W60](#)  
[10003](#) [10003/15](#) [10048](#) [10049](#) [10108](#) [CP10960\\_RGBX-SS](#) [CP12395\\_LXP3-W](#) [10415](#) [10510](#) [1-1000288-0](#) [F14487\\_FLORENCE-1R-](#)  
[MAXI-WG](#) [12667](#) [C14165\\_STRADA-2X2-ME-WIDE2](#)