

Technical Data

NKS7 Series

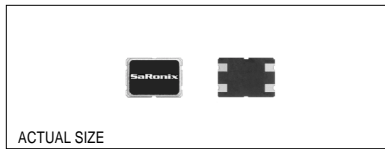

Description

The NKS7 Series incorporates a sub-miniature AT-cut strip crystal resonator housed in a standard 5x7 mm ceramic package. These compact crystals are ideal for surface mount, densely-populated PCB applications.

Applications & Features

- Fundamental frequencies available to 50MHz
- Rugged AT-cut crystal construction
- Extremely small SMD package
- Ideally suited for disc drives, PCMCIA, PC's and hand-held products
- Available on tape & reel; 16mm tape, 1000pcs per reel

Frequency Range:

Fundamental: 8 MHz to 30 MHz (available to 50 MHz, please contact SaRonix)
 3rd Overtone: 30 MHz to 83 MHz

Temperature Range:

Operating: -20 to +70°C, -40 to +85°C available, contact SaRonix
 Storage: -40 to +85°C

Temperature

Stability Tolerance: ±50ppm over -20 to +70°C (for tighter tolerances contact Saronix)

Characteristics @ 25°C ±2°C:

Frequency Calibration Tolerance: ±50ppm (for tighter tolerances contact Saronix)
 Load Capacitance: 8 to 32pF, or Series Resonant
 Effective Series Resistance: 60Ω max, 8 to 16 MHz
 30Ω max, 16+ to 30MHz
 80Ω max, 30+ to 40MHz
 70Ω max, 40+ to 83MHz
 Drive Level: 100μW correlation, 500μW max
 Shunt Capacitance: 7pF max

Mechanical:

Shock: ±5ppm max after 3 drops from 75cm onto a hard wooden board
 Solderability: MIL-STD-883, Method 2003
 Vibration: ±5ppm max sine vibration 10-55Hz, sweep period 1-2 minutes, amplitude 1.5mm, 3 mutually perpendicular planes each 1 hour.
 Solvent Resistance: MIL-STD-202, Method 215
 Resistance to Soldering Heat: MIL-STD 202, Method 210, Condition I or J

Environmental:

Gross Leak Test: MIL-STD-883, Method 1014, Condition C
 Fine Leak Test: MIL-STD-883, Method 1014, Condition A2
 Thermal Shock: MIL-STD-883, Method 1011, Condition A
 Moisture Resistance: MIL-STD-883, Method 1004

Part Numbering Guide

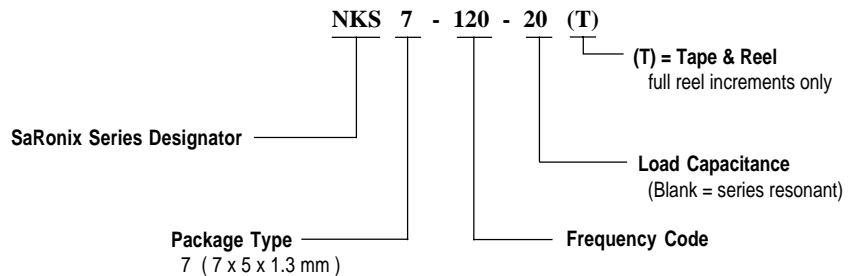

Technical Data

NKS7 Series

Package Details

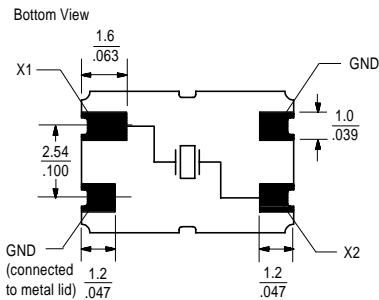
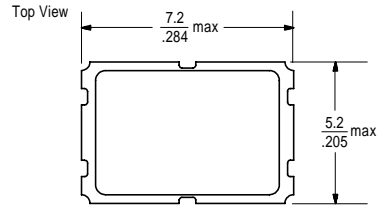

Marking Format **

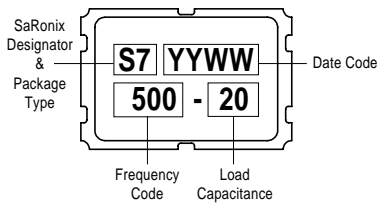

** Exact location of items may vary

Recommended Land Pattern

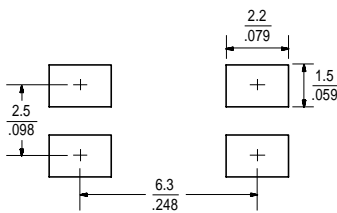

Solder Reflow Guide

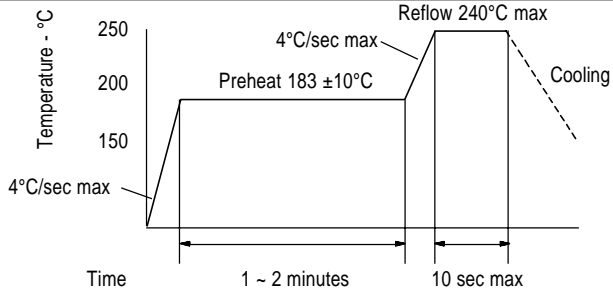

Common Frequencies

Frequency (MHz)	SaRonix Part Number	Frequency (MHz)	SaRonix Part Number
8.000000	NKS7-080-20	20.000000	NKS7-200-20
8.000156	NKS7-081-20	20.275200	NKS7-202-20
8.192000	NKS7-082-20	20.480000	NKS7-204-20
9.392000	NKS7-093-20	20.833000	NKS7-208-20
9.830400	NKS7-098-20	20.945000	NKS7-209-20
10.000000	NKS7-100-20	22.118400	NKS7-221-20
10.108800	NKS7-101-20	23.040000	NKS7-230-20
10.360000	NKS7-103-20	24.000000	NKS7-240-20
11.000000	NKS7-110-20	24.000140	NKS7-241-20
11.059200	NKS7-111-20	24.192000	NKS7-242-20
11.428000	NKS7-114-20	24.576000	NKS7-245-20
12.000000	NKS7-120-20	25.000000	NKS7-250-20
12.352000	NKS7-123-20	26.800000	NKS7-268-20
12.500000	NKS7-125-20	27.000000	NKS7-270-20
12.800000	NKS7-128-20	28.636360	NKS7-286-20
12.900000	NKS7-129-20	30.000000	NKS7-300-20
13.000000	NKS7-130-20	30.000000	NKS7-301-20
13.062500	NKS7-131-20	31.334400	NKS7-313-20
13.333333	NKS7-133-20	32.000000	NKS7-320-20
13.824000	NKS7-138-20	33.000000	NKS7-330-20
14.318180	NKS7-143-20	33.870000	NKS7-338-20
14.745600	NKS7-147-20	35.000000	NKS7-350-20
15.000000	NKS7-150-20	35.251200	NKS7-352-20
15.360000	NKS7-153-20	35.468000	NKS7-354-20
15.974400	NKS7-159-20	36.288000	NKS7-362-20
16.000000	NKS7-160-20	36.864000	NKS7-368-20
16.000312	NKS7-161-20	38.880000	NKS7-388-20
16.384000	NKS7-163-20	39.168000	NKS7-391-20
16.488000	NKS7-164-20	40.000000	NKS7-400-20
16.588800	NKS7-165-20	40.320000	NKS7-403-20
16.667000	NKS7-166-20	40.550400	NKS7-405-20
16.934400	NKS7-169-20	44.236800	NKS7-442-20
17.000000	NKS7-170-20	44.545000	NKS7-445-20
17.333333	NKS7-173-20	44.695000	NKS7-446-20
17.500000	NKS7-175-20	44.736000	NKS7-447-20
17.708333	NKS7-176-20	48.000000	NKS7-480-20
17.734400	NKS7-177-20	50.000000	NKS7-500-20
18.000000	NKS7-180-20	52.416000	NKS7-524-20
18.432000	NKS7-184-20	56.488000	NKS7-564-20
18.750000	NKS7-187-20	57.000000	NKS7-570-20
18.869600	NKS7-188-20	57.645000	NKS7-576-20
19.136000	NKS7-191-20	60.000000	NKS7-600-20
19.200000	NKS7-192-20	72.208333	NKS7-722-20
19.660800	NKS7-196-20	82.705000	NKS7-827-20

All specifications are subject to change without notice.

*Above the line parts are fundamental, below they are 3rd OT.

DS-115 REV F

X-ON Electronics

Largest Supplier of Electrical and Electronic Components

Click to view similar products for [saronix](#) manufacturer:

Other Similar products are found below :

[NKS7-400-20](#) [NKS7-100-20](#) [NKS7-184-20](#) [NKS7-120-20](#)