

Index

<i>Cat No.</i>	<i>PAGE</i>	<i>Cat No.</i>	<i>PAGE</i>	<i>Cat No.</i>	<i>PAGE</i>
0005	61,65	0919	41	5503	22
0023	78	0920	41	5508	22
0024	78	0936	47	6000	18
0033	82	0938	47	6000 Twin units	25
0035	83	992B	17,73	6001	18
0042	23,25,27,29	1041	67	6002	18
0046	19,21,23	1045	67	6003	18
0055	54	1047	76	6008	18
0056	54	1048	76,77	6009	18
0061	75	1050	76,77	6010	18
0062	75	1067	25	6011	18
0063	75	1080	61,63,65	6030	18,73
0067 Lampholder	75	1090	78	6050	24
0067 Neon	71	1091	78	6051	24
0081	70	1100	40	6052	24
0092	61,65	1101	40	6053	24
0095	75	1250	15	6054	24
0145	67	1300	20	6055	24
0167 Cover	11,13,14,35	13 112	16,17	6056	24
0177	71	13 208	16	6057	24
0180 Neon	71	13 211	17	6058	24
0180 Cover	13,14	1350	26	6059	24
0188 Cover	16,17	1353	26	6060	24
0195	67,72	1484	26	6061	24
0196	72	1487	26	6062	24
0232	63,65	1500	20	6066	24
0233	72	1500 Twin units	28	6067	24
0234	72	1501	20	6068	24
0245	67	1502	20	6090	24
0273	68,69	1510	20,28	6091	24
0275	69	1511	20	6092	24
0276	69	1520	20,28	7000	38
0277	69	1521	20	7001	38
0278	68	1522	20	7003	38
0279	61,65	1550	26	7004	38
0305	53	1551	26	7030	38,73
0306	53	1552	26	7050	38
0307	53	1553	26	7051	38
0308	53	1560	26	7053	38
0320	52	1561	26	7054	38
0323	42	1562	26	8200	36
0327	47	1570	26	8201	36
0331	61,65	1571	26	8250	36
0332	82	1572	26	8251	36
0333	82	1700	64	8300	34
0340	82	1710	64	8300 Vandal	44
0341	82	1710 Guard	63	8301	34
0345	83	1720	64	8301 Vandal	44
0347	83	1721	64	8303	34
0413	78	1722	64	8304	34
0430	20,73	1750	64	8350	34
0430 Twin units	28	1760	64	8350 Vandal	44
0434	21,23	1770	64	8351	34
0441	27	1911	43	8351 Vandal	44
0445	78	1961	43	8353	34
0480	26,73	22--	30-33	8354	34
0494	23,27,29	23--	30-33	8500	10
0506	61,65	24--	30-31	8500 Push	35
0520	82	25--	30-31	8503	10
0539	61,63,65	2760	69	8550	10
0568	68	2820	70	8550 Semi Rotary	11
0569	68	2821	70	8553	10
0579	71	2870	70	8580	10,73
0581	72	290-- Snap action	48	8600	12
0582	72	2950	67	8601	12
0586	70	2951	68	8602	12
0589	70	3005	55	8610	12
0600	61	3006	55	8611	12
0602	61	3101	56	8620	14
0616	27	3102	56	8630	12,73
0707	79	3111	56	8634	13
0708	79	3130	74	8650	12
0709	79	3141	57	8651	12
0710	79	3145	57	8652	12
0711	79	3146	57	8653	12
0717	80	3147	57	8660	12
0721	81	3160	74	8661	12
0722	81	3161	74	8670	14
0723	81	3221	74	8800	8
0873	83	340- Snap action	50	8800 Twin units	8
0910	42	390- Snap action	50	8801	8
0911	42,45	3900 Series	62	8802	8
0911 Vandal	42,45	3950 Series	62	9000	60
0916	41	4102	46	9100	58
0917	41	5500	22		
0918	41	5500 Twin units	23		

appliance switches

indicator lamps

fuseholders

IEC sockets

arcoelectric



Solutions for appliance & electronic applications

Catalogue 168
April
2003

this catalogue is available on CD
and on www.arcoelectric.co.uk



Arcoelectric Switches plc,
Central Avenue,
West Molesey, Surrey
England KT8 2RF

tel: +44 (0)20 8979 3232
fax: +44 (0)20 8979 2565
info@arcoswitch.co.uk
www.arcoelectric.co.uk



Solutions

for appliance & electronic applications

Arcoelectric Switches plc

Head Office, Sales and R&D

61 Central Avenue, West Molesey,
Surrey, England KT8 2RF

VAT Registration No. GB 211 3314 30

Tel +44 (0)20 8979 3232

Fax +44 (0)20 8979 2565

e-mail info@arcoswitch.co.uk

Web www.arcoelectric.co.uk

Directors

R.A. Collier

H.J.A. Cowley

J. Harris

J. Collier

M.A. Collier

I. Ranken Collins

Chairman

Managing Director

Technical Director

Director

Director

Non-executive Director

Company Secretary

D. Birdwood-Hedger

Export Sales

H.J.A. Cowley

L.A. Hamon

UK Sales

C. Macdonald

North American Customers

We have a 20,000sqft production
& distribution facility in Los Angeles:

Arcoelectric Corporation,

9001 Canoga Avenue, Canoga Park,
California 91304, USA.

Tel +1 818 700 1933

Fax +1 818 700 9541

e-mail info@arcoelectric.com

Web www.arcoelectric.com

President Carrie Bonica



Arcoelectric worldwide

Arcoelectric Switches plc, established in 1932, specialise in the manufacture of appliance switches, indicator lights and fuseholders for every kind of product from computers to coffee machines and lighting to laser printers.

We have two fully integrated factories totalling 90,000 sq.ft. in Surrey, England, where we manufacture mouldings, springs, pressings and turnings. The majority of our product is assembled automatically.

Arcoelectric also have purpose built factories in Shenzhen, China (42,000sq.ft) and Tunis, North Africa (30,000 Sq.ft.).

The Group has recently acquired Otehall Switches Ltd., a specialist manufacturer of high quality snap-action switches.

Arcoelectric Switches plc and Otehall Switches Ltd are wholly owned subsidiaries of Arcoelectric Holdings plc, a Public Company quoted on the Alternative Investment Market (AIM) in London.

Profile



Approvals

The majority of Arcoelectric products are covered by international approvals. These will assist you in obtaining worldwide approval of your own products.

Europe - The  ENEC mark replaces national approval marks for switches complying with product standard EN61058-1.

America - Switch approvals to UL1054.

Canada - Switch approvals to CSA C22.2 No.55-M1986.

Our North African and China factories are also approved by these authorities.

Quality Assurance Approval



We are a BSI Registered Firm to BS EN ISO 9002: 1994. Certificate No: FM 14821.

Not all products are produced on site, such items are therefore not manufactured under this approval.

  Appliances bearing the  mark are able to circulate freely in Europe. Products in this catalogue, when fitted correctly, comply with the  requirement insofar as it relates to them.

Product from stock

For stock product availability please visit our website, call our sales office or contact your nearest agent or distributor, listed on the back of this catalogue.













Bankers

HSBC Bank plc,
56 High Street, Esher, Surrey, KT10 9RD.
Sterling Account No. 21148257 Sort Code: 40-20-26

HSBC Bank plc,
P.O. Box 181, 27-32 Poultry, London, EC2P 2BX.
U.S. Dollar Account No. 37038042 Sort Code: 40-05-15
Euro Account No. 39023138 Sort Code: 40-05-15

The Hong Kong and Shanghai Banking Corporation Limited,
1 Queen's Road, Central, Hong Kong.
U.S. Dollar Account No. 600-833255
Hong Kong Dollar Account No. 600-833255-001

contents

4, 6, 66	technical data	
8 - 29	rocker switches	
30 - 33	slide switches	
34 - 47	push switches	
42 - 45	vandal resist switches	
48 - 52	snap-action & safety switches	
53 - 57	refrigerator switches	
58 - 60	rotary switches	
61 - 65	lever switches	
66 - 78	indicators	
79 - 81	IEC sockets	
82 - 83	fuseholders	



Solutions

for appliance & electronic applications



6 Million Products

Every month we assemble over six million switches, indicator lights, fuseholders and IEC sockets.

5 Manufacturing Centres

Almost all component parts used in our products - mouldings, pressings, springs and turned parts, are manufactured in our own production centres, then assembled and tested fully automatically.

23 Automatic Assembly Machines

The great majority of our rocker, slide, push button and lever switches are assembled automatically.

52 Injection Moulding Machines

Working at pressures up to 80 tons, our mould shop delivers over 250 million components each year.

60,000 Miniature Springs

Some only a millimetre or so in diameter, are wound each hour. Every one will be measured and tested.

15 Power Presses

We manufacture over 200,000 contacts and terminals every hour.

Production

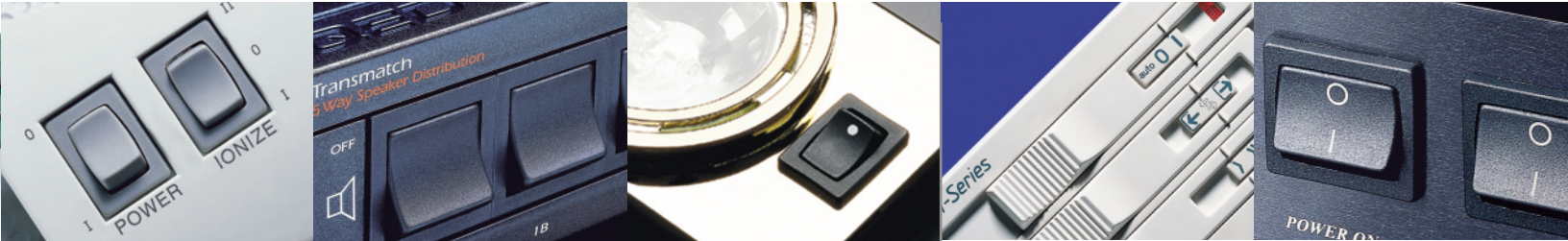

Automated Testing

Each assembly machine tests the electrical and mechanical function of every completed product.

8,000,000 turned parts

On site manufacture of our component parts ensures full control of our production.

Tooling - In-house

A fully equipped toolroom manufactures and maintains the jigs, press and mould tools we use each day.

Flexibility of response

Twenty-four hour running allows a positive response to customer requests and ensures a competitively priced finished product.

Research & Development

Our designers will work with you to achieve practical solutions which satisfy your particular design criteria.

Arcoelectric is the largest manufacturer of appliance switches in the UK.

effective

design

development

sampling

costing

production

distribution

support

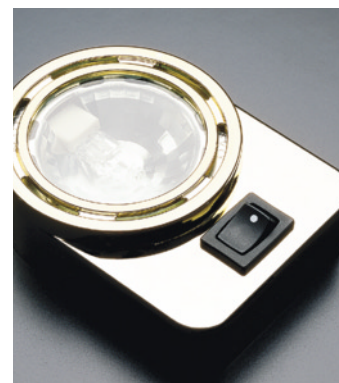

Technical Information - Switches and Fuseholders

Most major technical information is shown on each specific product page, other details are grouped here for easy reference. Details shown here apply to most switches and fuseholders.

Snap-action switches (pages 42, 45 and 48-51), indicators (pages 66-78) and connectors (pages 79-81) have product specific information within the section.

MATERIALS	MOST PRODUCTS	EXCEPTIONS
Body and actuator (opaque)	Nylon 6.6	8300V, 1900V, 0916V & 0911V bezels & actuators are stainless steel 0600 and 3900 actuators are plated brass
Actuator (transparent)	Polycarbonate	
Current carrying parts	Copper Alloy	
Contact points	Silver Alloy	N/A for 0055/56, 0600/2, 0916-0920, 0017, 2000 & 3005/3006. Gold plated for 1100.

PROPERTIES

Electrical

Class II compliant	Confirmed	IEC Sockets
Electrical life (Operations)	>10k, many >50k	See relevant page for details
Contact resistance (switches) new condition	<100mΩ (at 12Vdc,1A)	For 1100 & 2000 call factory
Contact resistance (fuseholders) new condition5mΩ (average)	
Insulation resistance	>20mΩ	
Dielectric strength:		
across open contacts	>1kV	
between poles	>3kV	
between live parts and accessible metal	>4kV	
Comparative Tracking Index (CTI)	>250	
Temperature rise (terminals) at end of rated life	max 30°K (UL 1054), max 55°K (EN 61058-1)	

PROPERTIES

Physical

Humidity resistance at 91-95% relative humidity (to subsequently comply with requirements of the Dielectric strength test)	48hrs	
Impact resistance	>0.5Nm	
Storage temp. (1 year period)	<125°C	Some discolouration of terminals may occur
Flame retardancy	UL94V2	
Solderability to BS 2011 pt.2.1T - (with an iron)	6 secs at 350°C	
Angular movement ± 4° overall (where applicable)	38°	1250, 6000, 8500, 8550, 8600, 8650, 8800 - 26°
Force to operate	2.0N - 20.0N	Call factory for specific values
Fixing nut torque (where applicable)	1.0Nm (8.91 lb/in) nom.	Call factory for specific values

GENERAL INFORMATION

ALL SWITCHES

Heat and Fire resistance Category D.
 Ingress Protection without cover is IP40.
 Higher ratings where available will be shown on the relevant catalogue page.

ALL PRODUCTS

Solder terminals should not be fitted with "Push on", "OD" or "Fast on" type cable connectors.

Panel holes must be punched in the direction of insertion.

Items marked ♦ on the following pages are assembled automatically. This ensures the highest attainable quality at a competitive price.

All products should be applied, installed and maintained by the customer using competent persons in accordance with good electrical practice. Products should be tested by the customer in the application to ensure suitability. Special care should be taken not to expose switches to water, dust, corrosive chemicals, silicone, excessive solder flux, cyanoacrylate adhesives, severe impact, extremes of temperature, electrical supply voltage or load current in excess of the specified limits.

Transparent lenses on indicator lights and lit switches are moulded in polycarbonate, a material which is attacked by organic chemicals and animal or vegetable fats.
 Please contact the factory for advice on these products.

For performance in accord with the stated ratings, switch actuators should be fully depressed and fully released during operation.

WEIGHTS OF OUR MOST FREQUENTLY SUPPLIED PRODUCTS, not including packaging.

Product	gms	Product	gms	Product	gms	Product	gms	Product	gms
0055, 0056	5.7/6.8	1048	2.8	1570	12.7	5500	7.1	8353	5.9
0305	32.9	1091FH	12.6	1584-1589	11.1	5503	7.8	8500	3.8
0333	4.5	1091FL	52.8	1700H	8.4	5567	14.3	8550	4.8
0345	8.9	1100	2.0	1750H	13.2	6050	13.58	8553	5.2
0340 sw only	7.12	1250SP	5.9	17500	25.6	6053	14.15	8600	3.5
0340K/P	25.0	1250DP	7.0	2000 2pos C SP	3.8	7000	10.4	8620	4.3
0430	5.5	1300	5.7	2000 2pos C DP	4.5	7050	12.3	8650	6.3
0589	3.5	1350	11.2	2000 5pos A SP	6.3	7053	12.9	8670	8.5
0711-1S	16.6	1500	5.7	2000 5pos A DP	7.3	8250	4.9	8800	2.9
0712-S	27.8	1520	6.6	T2225B	5.0	8300	4.0	9100	20.0
0717-1S	22.4	1550	11.2	2950	5.3	8350	5.0		
0900S/L	2.6/2.9	1553	11.8	3111	11.8	8350RP	34.0		

Splashproof & Dust Resistant options for Switches

Suitability

A large number of Arcoelectric products have optional or designed-in resistance to moisture or dust. For detailed IP ratings call the factory. The suitability of these products for specific applications is subject to numerous factors including:

Mounting method and product orientation, air movement, pressure differential across the product, intensity of impinging liquid flow and application voltage. Splashproofing does not imply total sealing, or resistance to corrosive atmospheres or substances.

<p><i>Order code for splash/dust proofing options is shown under the illustration</i></p>	<p><small>Page 10</small></p>  <p>8500 Twin can be fitted with</p>  <p>L167 Push-on cover</p>	<p><small>Pages 12 & 14</small></p>  <p>8600 & 8620 can be fitted with</p>  <p>L167 Push-on cover</p>	<p><small>Pages 12 & 14</small></p>  <p>8650 & 8670 can be fitted with</p>  <p>L180 Push-on cover</p>	<p><small>Page 16</small></p>  <p>R13 Single pole can be fitted with</p>  <p>L188 Push-on cover</p>	<p><small>Page 16</small></p>  <p>R13 Double pole can be fitted with</p>  <p>L188 Push-on cover</p>
---	---	---	---	---	---

<p><i>Order code for splash/dust proofing options is shown under the illustration</i></p>	<p><small>Page 18</small></p>  <p>6000 has integral water-thru feature and</p>  <p>G Snap-on cover option</p>	<p><small>Page 20</small></p>  <p>1500 and 1300 available with W or B Splashproof rockers or</p>  <p>G Snap-on cover</p>	<p><small>Page 22</small></p>  <p>5503 can be fitted with</p>  <p>G Snap-on cover</p>	<p><small>Page 24</small></p>  <p>6050 has integral water-thru feature and</p>  <p>G Snap-on cover option</p>	<p><small>Page 26</small></p>  <p>1550 and 1350 can be fitted with</p>  <p>G Snap-on cover</p>
---	---	--	---	---	--

How they work

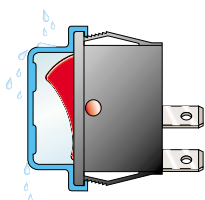

L167, L180, L188
Push-on splashproof/
dustproof covers
for rocker/push switches

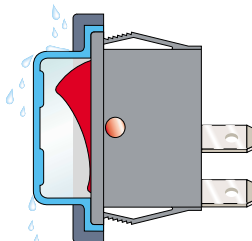

G
Snap-on splashproof/
dustproof cover & bezel
for rocker switches

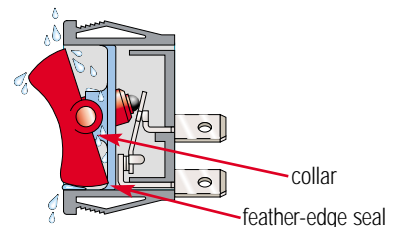

1500 W and 1500 B splashproof rockers
have internal feather edge seals and a close fitting collar to protect current carrying parts from moisture
Option B has Hytrel moulded collar/seals for enhanced protection

The right system

The fitting of external covers or panel sealing washers will normally alter standard panel acceptance dimensions.

The fitting of external covers is not recommended for momentary (spring return) rocker or lever switches.

In all instances applications should be discussed with the factory. We will advise you on the best system for your application.

For full product details, dimensions and ratings refer to the catalogue page shown in the photograph (not to scale).

Order code for splash/dust proofing options is shown under the illustration

Page 34



8300
can be fitted with



L167
Push-on cover

Page 41



0916V
has integral seal

Page 43



1900
has integral seal

Page 44



8300V
has integral seal

Page 45



0911V
has integral seal

Order code for splash/dust proofing options is shown under the illustration

Page 55



3005
splashproof design

Page 56/57



3100 and 3141
splashproof design

Page 62



3900 and 3950
have integral O-ring seal and can be fitted with



M539 or M1080
neck seal or cover

Page 64



1700 and 1750
can be fitted with



M331, M539, M1080
covers or neck seals

Page 61



0600
can be fitted with



M331, M539, M1080
covers or neck seals

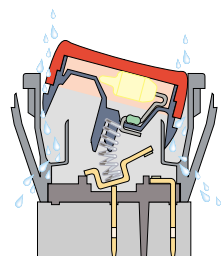

Water-thru
Integral splashproof system (pat app.)

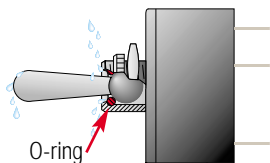

O-ring
Integral seal for 3900 series metal lever switches

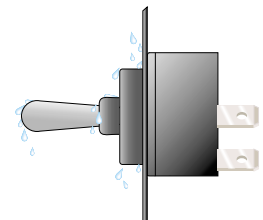

Covers & Neck seals
(with nut fixing) for lever switches

8800 Thinline Rocker Switches 10A 250Vac



10(6)A 250Vac T100
6(2)A 250Vac T100 5E4 (50,000 Operations)
Inrush 50A to EN60065:1998



UL CSA 15A 250Vac (Twin unit is 10A 250Vac)
UL CSA 125Vac 1/2hp
UL 100°C, file E45221, CSA file LR10990

In house test 10A 28Vdc

3mm contact gap
Technical data on pages 4 & 5

H 8800 V A - - -
 TERMINAL FUNCTION ROCKER BODY PRINT, COLOUR, ETC

▶ TERMINAL	▶ FUNCTION		▶ ROCKER
H 4.8 x 0.8		 Switches are ON when pressed over terminal 1	V Curved
	8800 ⚡	 ON - OFF Single pole	
	 8801 Call factory for ratings & dimensions	 ON - OFF (momentary ON) Single pole	
T 3.5 x 0.8 Solder	 8802 Call factory for ratings & dimensions	 ON - OFF (momentary OFF) Single pole	
		 Switches are ON when pressed over terminals 1 or 3	
	8800/8800	 ON - OFF Twin (Single pole)	



H8800VA ---
T8800VA ---



H8800VA ---
T8800VA ---



H8800V/H8800VA
T8800V/T8800VA



H8800V/H8800VA
T8800V/T8800VA

BODY

Panel cut-outs Flange
Cut-outs must be punched in the direction of insertion

A Single pole

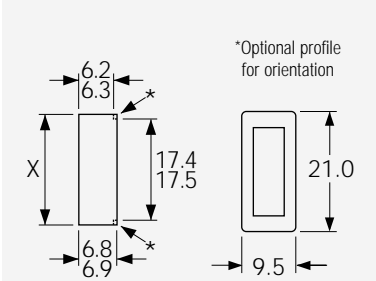

A Single pole - Twin

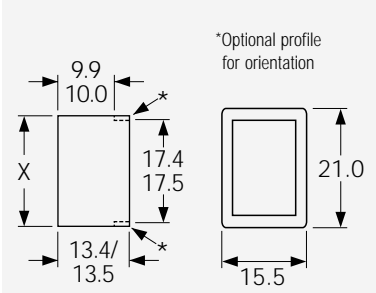

Panel thickness	Dim X
0.75-1.24	19.1/19.2
1.25-1.99	19.3/19.4
2.00-3.00	19.7/19.8

OPTIONS

Finish
Matt finish only

Colour
Call factory for custom colours.
A full range is available for large orders

Legend printing
Select from the examples or call the factory for custom legends

Dimensions (mm)

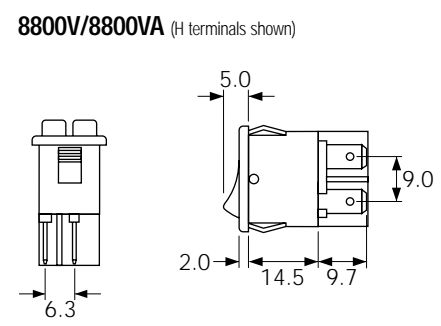
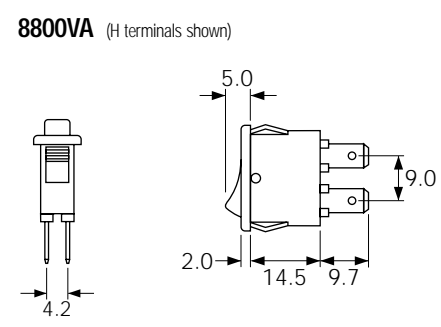

Examples of printing



CL132

CL133

8500 Rocker Switches - Miniature 10A 250Vac Single & Double Pole



10(6)A 250Vac T125 (non lit types)
6(4)A 250Vac T125 5E4 (50,000 Operations) (non lit types)
10(6)A 250Vac T100 (lit types)



UL CSA 15A Non Ind 250Vac, 14A Ind 250Vac, 10A 277Vac
UL CSA 250Vac 1/2hp, 125Vac 1/4hp
UL 105°C, file E45221, CSA file LR10990



Inrush 85A to EN61058-1 & 10A 28Vdc

3mm contact gap

Technical data on pages 4 & 5 (switches), 66 (indicators)

H 8550 V B ---

TERMINAL FUNCTION ROCKER BODY PRINT, COLOUR, VOLTAGE ETC

TERMINAL	FUNCTION	ROCKER
<p>H</p> <p>4.8 x 0.8</p>	<p>Approvals & ratings vary with function</p> <p>On Off Switches are ON when pressed over terminal 1</p>	<p>H Slotted for custom adaptors Slots for snap-in buttons</p>
<p>K</p> <p>2.8 x 0.8</p>	<p>8500 ♦</p> <p>ON - OFF Single pole (Uses terminals 1a & 2a)</p>	<p>R Semi-rotary</p>
<p>L</p> <p>2.8 x 0.8</p> <p>Right angle version of K terminal available on 8500 only</p>	<p>8503 ♦</p> <p>ON - OFF - Lit Single pole</p>	<p>D Paddle lever (8500 only) (not lit)</p>
<p>R</p> <p>4.8 x 0.8</p>	<p>8550 ♦</p> <p>ON - OFF Double pole</p>	<p>V Curved (not lit)</p>
<p>T</p> <p>4.8 x 0.8</p> <p>Solder</p>	<p>8580</p> <p>Available with H terminals only</p> <p>Indicator</p>	<p>V Curved (lit)</p>
		<p>X Two colour (not lit)</p>
		<p>A Softline lens</p>

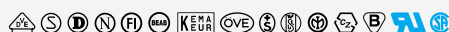



H8500VB ---
T8500VB ---



H8550VB ---
T8550VB ---



H8550XB ---
T8550XB ---

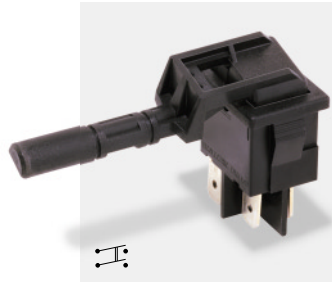

H8550RB Semi-rotary
A splash proofing option

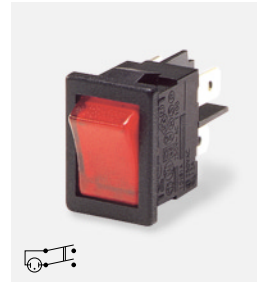

H8553VB ---
T8553VB ---



H8580AB ---

BODY

Panel cut-outs Flange
Cut-outs must be punched in the direction of insertion

B
Standard body with terminal barrier

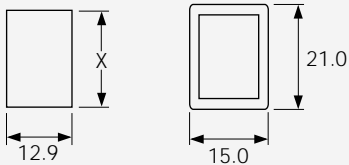

BC
Body without terminal barrier

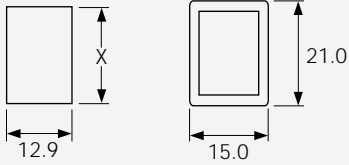

Dimensions for snap-in fixing

Panel thickness	Dim X
0.75-1.25	19.1/19.2
1.25-2.00	19.3/19.4
2.00-3.00	19.7/19.8

OPTIONS

Finish
Matt finish only

Colour
Call factory for custom colours
A full range is available for large orders

Legend printing
Select from the examples or call the factory for custom legends

Lamp voltage
Call factory for details of other available voltages

Protective cover L167
(designed to IP65)
Snaps on to bodies with V or X style rockers and A style lens but reduces panel thickness by 0.8mm



DIMENSIONS (mm)

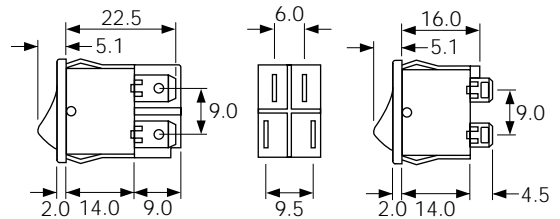

"B" body with barrier for H, T and K terminals

"BC" body w/o barrier primarily for L or R terminals (can be used for all terminals)

Terminal spacing between 1a & 3b - 6.0, between 2a & 4b - 9.5

Examples of printing



CL076



CL080

8600 Rocker Switches - Miniature 10A 250Vac Single & Double Pole



10(4)A 250Vac T90 (unless noted below)



UL CSA See ratings below
UL 65°C, file E45221, CSA file LR10990

In house test

Inrush 25A to EN61058-1 & 10A 28Vdc

3mm contact gap except where marked μ
Technical data on pages 4 & 5 (switches), 66 (indicators)

H 8653 V B ---

TERMINAL FUNCTION ROCKER BODY PRINT, COLOUR, VOLTAGE ETC

TERMINAL	FUNCTION	ROCKER
<p>H</p> <p>4.8 x 0.8</p>	<p>Approvals & ratings vary with function</p> <p>On Off Switches are ON when pressed over terminal 3</p>	<p>V Curved</p>
<p>T</p> <p>3.5 x 0.8 Solder</p>	<p>8600 \blacklozenge ON - OFF 10(4)A 16A 250V, 10A 277V</p> <p>8650 \blacklozenge ON - OFF 10(4)A 10A 277V</p>	<p>V Curved (lit)</p>
<p>X</p> <p>PCB* 0.8 Sq</p>	<p>8601 \uparrow ON - OFF (momentary ON) 6(1)A 16A 250V, 6A 277V</p> <p>8651 \uparrow ON - OFF (momentary ON) 6(1)A 6A 277V</p> <p>8602 \downarrow ON - OFF (momentary OFF) 10A 16A 250V, 10A 277V</p> <p>8652 \downarrow ON - OFF (momentary OFF) 10(4)A 6A 277V</p>	<p>D Paddle lever (Single pole non-lit only)</p>
<p>Y</p> <p>Right angle PCB 1.3 x 0.8 Contact the factory for details</p>	<p>8610 \blacklozenge ON - ON 6(1)A 10A 277V</p> <p>8660 \blacklozenge ON - ON 6(1)A 10A 277V, 1/2HP 277V 1/2HP 250V, 1/4HP 277V</p> <p>8611 ON - OFF (momentary 1 side) 6A 277V</p> <p>8661 ON - OFF (momentary 1 side) 6A 277V</p> <p>8620 μ ON - OFF - ON See page 14</p> <p>8670 μ ON - OFF - ON See page 14</p>	<p>F Flat Indicator only (Single pole)</p>
<p>*Switches with "X" terminals are supplied without terminal barriers</p>	<p>8630 Indicator</p>	





H8600VB ---
T8600VB ---



H8600VB ---
T8600VB ---



H8630FB ---
T8630FB ---



H8650VB ---
T8650VB ---



H8660VB ---
T8660VB ---



H8653VB ---
T8653VB ---

BODY

Panel cut-outs Flange
Cut-outs must be punched in the direction of insertion

B Single pole

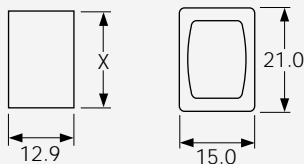

Single Pole dimensions for snap-in fixing

Panel thickness	Dimension X
0.75-1.24	19.1/19.2
1.25-1.99	19.3/19.4
2.00-3.00	19.7/19.8

B (Double Pole) with terminal barrier BC (Double Pole) w/o terminal barrier

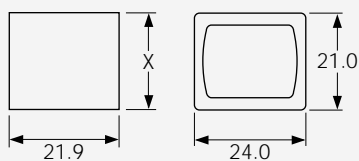

Double Pole dimensions for snap-in fixing

Panel thickness	Dimension X
0.75-1.24	19.1/19.2
1.25-1.99	19.3/19.4
2.00-3.00	19.7/19.8

OPTIONS

Finish

Matt finish only

Colour

Call factory for custom colours
A full range is available for large orders

Legend printing

Select from the examples or call the factory for custom legends

Lamp voltage

Call factory for details of other available voltages

Blanking plate A8634FB

Dummy unit to fill unused panel holes
Single pole size only

Protective covers

L167 for SP

L180 for DP

(designed to IP65)

Snap on to bodies with V rocker or F lens
but reduce panel thickness by 0.8mm.
Not for use with momentary types



Single Pole options

Most switches shown can have single pole switching in double pole bodies

DIMENSIONS (mm)

Single pole

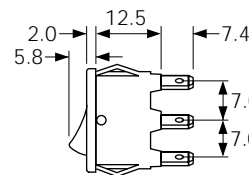

Terminals shown are "H" 4.8 push on type

Double pole

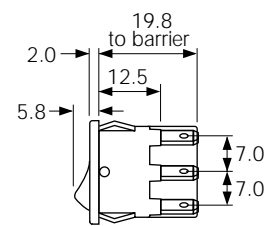

Terminal spacing 10.2 between pole centres

For 8620 and 8670 see page 14

Examples of printing

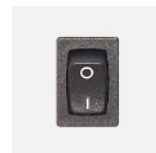

CL076

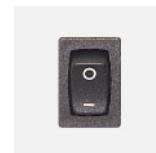

CL080



CL141



CL142



CL059



CL058

8620 & 8670 Rocker Switches - 3 Positions 10A 250Vac



10(4)A 250Vac T90



- UL CSA 15A 277Vac (Single pole)
- UL CSA 250Vac 1/2hp (Single pole)
- UL CSA 125Vac 1/4hp (Single pole)
- UL CSA 10A 277Vac (Double pole)
- UL CSA 125/250Vac 1/2hp (Double pole)
- UL CSA 277Vac 1/2hp (Single & Double pole)
- UL 90°C, file E45221, CSA file LR10990

In house test 10A 28Vdc

μ contact gap
Technical data on pages 4 & 5









H8620VB - - -
T8620VB - - -

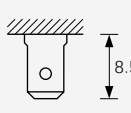

H8670VB - - -
T8670VB - - -

H 8620 V B - - -

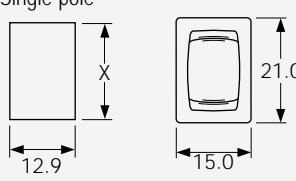
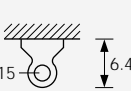
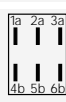
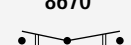
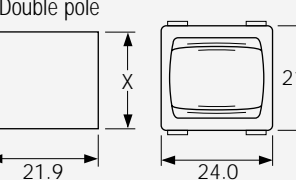
TERMINAL FUNCTION ROCKER BODY PRINT, COLOUR, ETC

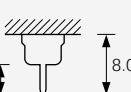
TERMINAL	FUNCTION	ROCKER	BODY	OPTIONS
<p>H</p>  <p>4.8 x 0.8</p>	 <p>8620</p>  <p>ON - OFF - ON Single pole</p>	<p>V Curved</p> 	<p>B Single pole</p>  <p>Panel thickness Dim X 0.75-1.24 19.1/19.2 1.25-1.99 19.3/19.4 2.00-3.00 19.7/19.8</p>	<p>Finish Matt finish only</p> <p>Colour Call factory for custom colours. A full range is available for large orders</p> <p>Legend printing Select from the examples or call factory for custom legends</p>
<p>T</p>  <p>Ø2.15</p> <p>Solder</p>	 <p>8670</p>  <p>ON - OFF - ON Double pole</p>		<p>B Double pole</p>  <p>Panel thickness Dim X 0.75-1.24 19.1/19.2 1.25-1.99 19.3/19.4 2.00-3.00 19.7/19.8</p>	<p>Protective covers IP65 L167 for SP L180 for DP (designed to IP65) Snaps on to body but reduces panel thickness by 0.8mm</p> 
<p>X</p>  <p>4.0</p> <p>PCB 0.8sq</p> <p>Switches with X terminals are supplied without terminal barriers</p>			<p>Cut-outs must be punched in the direction of insertion</p>	

Dimensions (mm)

8620VB (H terminals shown)

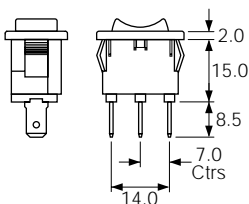

8670VB (H terminals shown)

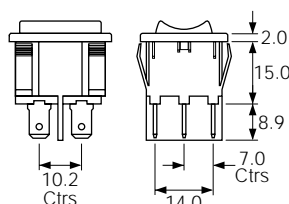

8670VB (X terminals shown)

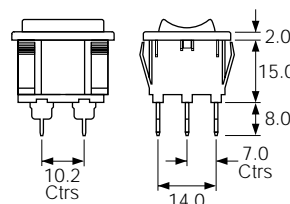

Examples of printing



CL141



CL142

1250 Rocker Switches 10A 250Vac



10(6)A 250Vac T100
6A 400Vac T100
1A 30Vdc



UL CSA 10A 250Vac
UL CSA 16A 250Vac Resistive
UL CSA 125Vac 1/2hp
UL CSA 1A 30Vdc
UL 100°C, file E45221, CSA file LR10990

In house test

Inrush 75A to EN61058-1 & 10A 28Vdc

3mm contact gap

Technical data on pages 4 & 5



C1250AP - - -



C1250AN - - -

C 1250 A P - - -

TERMINAL FUNCTION ROCKER BODY PRINT, COLOUR, ETC

TERMINAL	FUNCTION	ROCKER	BODY	OPTIONS
<p>C</p> <p>6.3 x 0.8</p>	<p>On when pressed over terminal 1</p> <p>1250 ♦</p> <p>ON - OFF Double pole</p> <p>Poles are 9.0mm between centres.</p>	<p>A Curved</p> <p>Shown in N body</p>	<p>N Panel cut-out</p> <p>Sub-panel</p> <p>Panel thickness 0.75-1.24 1.25-1.99 2.00-3.00</p> <p>Dim X 26.1/26.2 26.3/26.4 26.7/26.8</p> <p>Flange</p>	<p>Finish Matt finish only</p> <p>Colour Call factory for custom colours. A full range is available for large orders</p> <p>Legend printing Select from the examples or call factory for custom legends</p>
<p>X</p> <p>PCB 0.8sq (N body only)</p>	<p>On when pressed over terminal 1</p> <p>1250SP ♦</p> <p>ON - OFF Single pole</p>	<p>P Curved</p> <p>Shown in P body</p>	<p>P Panel cut-out</p> <p>Panel thickness 0.75-3.00</p> <p>Flange</p> <p>Cut-outs must be punched in the direction of insertion</p>	

Dimensions (mm)

1250AN (C terminals shown)

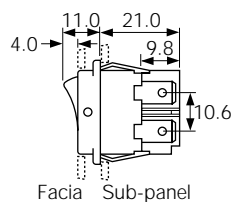

1250AN (X terminals shown)

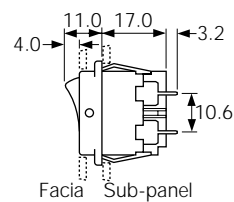

1250AP (C terminals shown)

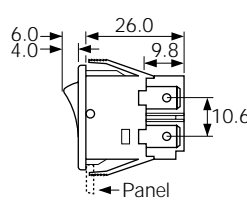

Examples of printing

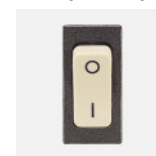

CL085



CL086

R13 Round Rocker Switches 6A 250Vac



SP 6A 250Vac T85,
DP 10(4)A 250Vac T85



UL CSA SP 10A 125Vac & 6A 250Vac (For 16A call the factory)
UL CSA DP 8A 125/250Vac
UL 85°C, file E67774(S) CSA file LR45128

Single pole has μ contact gap
Technical data on pages 4 & 5

Standard products

Are supplied with the body and rocker colour, print & lamp voltage shown in the product illustration and description

R13 112A AAA

TERMINAL FUNCTION ROCKER BODY PRINT, COLOUR, VOLTAGE ETC

PRODUCT DETAILS



SP ON - OFF μ
Cat no.
R13 112A AAA



SP ON - OFF μ
Lit 230V
Cat no.
R13 112B NAC



SP ON - OFF μ
Cat no.
R13 112A AAB



SP ON - ON μ
Cat no.
R13 112C AAA



SP ON - OFF μ
Lit 230V
Cat no.
R13 112B NAA



SP ON - OFF - ON μ
Cat no.
R13 112D AAA



SP ON - OFF μ
Lit 230V
Cat no.
R13 112B NAB



only

SP ON - OFF μ
(Momentary On)
Cat no.
R13 208F AAA*



DP ON - OFF
Cat no.
R13 244A AAA



DP ON - OFF μ
Lit 230V
Cat no.
R13 244B NAA

DIMENSIONS (mm)

Panel cut-out

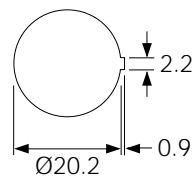

Snap fixing into panel thickness up to 3.0

Single pole

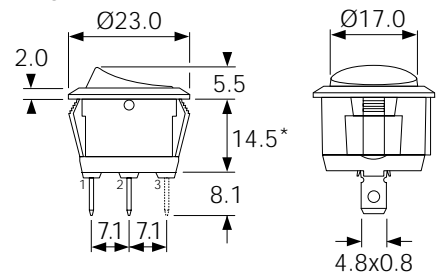

* R13 208F has 12.5mm deep body

Double pole

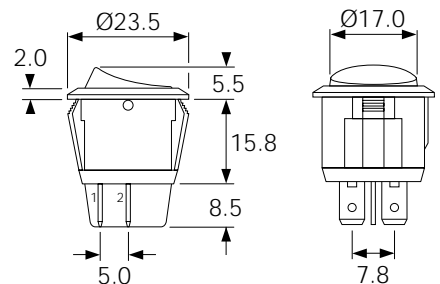

R13 Round Rocker Switches 6A 250Vac



6A 250Vac T85

UL CSA 10A 125Vac & 6A 250Vac (For 16A call the factory)
UL 85°C, file E67774(S) CSA file LR45128

Single pole has μ contact gap
 Technical data on pages 4 & 5

Special products

Are made to order and can be supplied with a range of body and rocker/lens colours, print & lamp voltage

Call the factory for availability to your special requirements

R13 112A2 - -

TERMINAL FUNCTION ROCKER BODY PRINT, COLOUR, VOLTAGE ETC

PRODUCT DETAILS

	 SP ON - OFF μ Bright colour ON signal Cat no. R13 112A2 - -	 4.8x0.8
	 SP ON - OFF μ Lit Window Cat no. R13 112B2 - -	 4.8x0.8
	 SP ON - OFF μ Paddle tip has red LED Cat no. R13 112LP - -	 4.8x0.8
	 Indicator light Cat no. R9 92B - - -	 4.8x0.8
	 SP ON - OFF μ R13 211A - - -	 4.8x0.8
	 SP ON - ON μ R13 211C - - -	

PANEL CUT-OUT (mm)

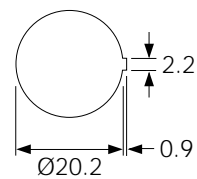

For R13 112A2
 R13 112B2
 R13 112LP
 R9 92B

Snap fixing into panel thickness up to 3.0



Protective cover L188

Snaps on to bodies (not R13 211 or R13 112LP) but reduces panel thickness by 0.6mm

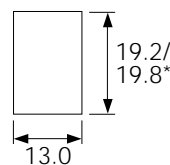

For R13 211A
 R13 211C

* Dependent on panel thickness 0.75 - 3.0

6000 SP Splashproof Rocker Switches 16A 250Vac



European 16(4)A 250Vac T125, 10A 400Vac T125



UL CSA 20A+ 277Vac, 250Vac 1 1/2hp, 125Vac 1hp
UL 100°C, file E45221, CSA file LR10990

In house test

Inrush 150A* to EN61058-1 (On - Off only)
20A 28Vdc

* * applies to non-momentary types

6000 Switches feature "Arcshield" to hide visible switching arc
3mm contact gap with Positive Break switching
Call factory for IP details
Technical data on pages 4 & 5 (switches), 66 (indicators)
Patent app.

C 6003 A L ---

TERMINAL FUNCTION ROCKER BODY PRINT, COLOUR, VOLTAGE ETC

▶ TERMINAL	▶ FUNCTION	▶ ROCKER
<p>C</p> <p>6.3 x 0.8</p>	<p>Approvals & ratings vary with function On Off Switches - ON when pressed over terminal 3</p>	<p>A Softline Matt</p>
	<p>6000 ON - OFF</p>	
	<p>6001 ON - OFF (momentary ON)</p>	<p>A Softline Matt</p> <p>Lit</p>
	<p>6002 ON - OFF (momentary OFF)</p>	
	<p>6003 ON - OFF Lit</p>	<p>P Lit window Matt</p>
	<p>6008 ON - OFF Lit (Unswitched neutral)</p>	
	<p>6009 ON - OFF (momentary ON) Lit (Unswitched neutral)</p>	
	<p>6010 ON - ON</p>	<p>A Lens Matt (6030 indicator only)</p>
	<p>6011 ON - ON (momentary 1 side)</p>	
	<p>6030 Indicator</p>	
<p>H</p> <p>4.8 x 0.8</p>		
<p>S</p> <p>Screw & Clamp N/A for assemblies with 3 terminals</p>		
<p>For twin switches and double pole circuits see pages 24 & 25</p>		

For IP65 see "options" below

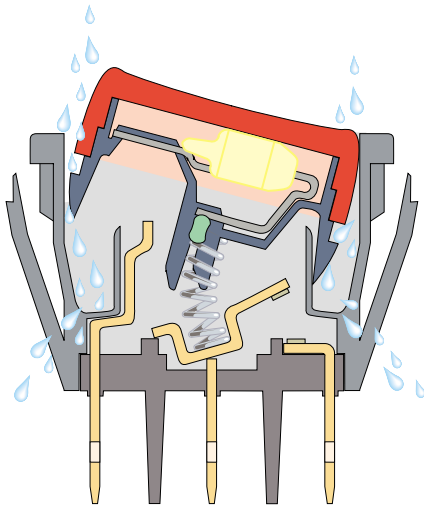

Integral Splashproofing

Current carrying parts are protected from moisture. Droplets which may enter the switch are channelled out through ports in the switch body



C6000AL ---



C6000AL ---



C6010AL ---



C6003AL ---



C6003PL ---



C6030AL --



BODY

Panel cut-out ** Flange
Cut-outs must be punched in the direction of insertion

L

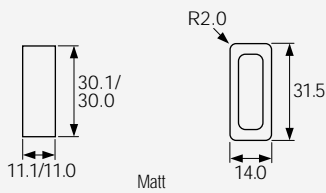

Matt

OPTIONS

Finish Matt is standard

Colour Call factory for custom colours
A full range is available for large orders

Legend printing Select from the examples or call factory for custom legends

Lamp voltage Call factory for details

Protective cover (designed to IP65)
The 6000 series is a water thru design. For a higher level of sealing, a snap on cover is available (add G after body code). This reduces panel thickness by 1mm.

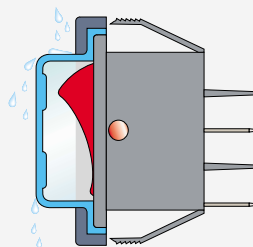

Panel sealing washer W46 is available but reduces panel thickness by a further 0.8mm. Covers are not suitable for momentary types.

Mounting orientation may affect splashproofing

For all options call the factory

DIMENSIONS (mm)

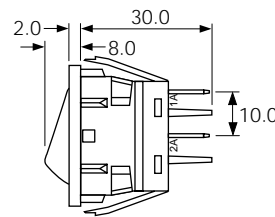

Panel thickness

L 0.75 to 2.5mm

** For cut-out details on momentary switches call the factory

Examples of printing



EN1224



EN1223

1500 Standard & 1300 Hi Inrush Switches 150A to IEC65 and 16A 250Vac



1500 Series 16(4)A 250Vac T125



UL CSA 16A Non Ind 250Vac, (2 posn) 250Vac 1hp, 125Vac 1/2hp, (3 posn) 250Vac 1/2hp, 125Vac 1/4hp UL 85°C, file E45221, CSA file LR10990

In house test

Inrush 36A to EN61058-1 & 20A 28Vdc



1300 series 16(6)A 250Vac T125 5E4 (50,000 Ops.) Ⓢ 150A Inrush to IEC 65,



UL CSA 20A 250Vac 1hp, 125Vac 1/2hp UL 85°C, file E45221, CSA file LR10990

In house test

20A 28Vdc

3mm contact gap except if marked μ . Technical data on pages 4 & 5 (switches), 66 (indicators)

C 1300 A L ---

TERMINAL FUNCTION ROCKER BODY PRINT, COLOUR, VOLTAGE ETC

TERMINAL	FUNCTION	ROCKER
<p>C</p> <p>6.3 x 0.8</p>	<p>Approvals & ratings vary with function On Off Switches - ON when pressed over terminal 1</p>	<p>A Softline Matt</p>
<p>H</p> <p>4.8 x 0.8*</p>	<p>Standard 1500 ♦</p> <p>Hi Inrush 1300 ♦ <small>Approvals apply to C & T terminals only</small></p> <p>ON - OFF</p>	<p>B Splashproof (with Arcshield) Matt</p>
<p>K</p> <p>2.8 x 0.8*</p>	<p>1501 <small>HP rating N/A</small></p> <p>ON - OFF (momentary ON)</p>	<p>H Slotted (for custom Adaptors) not momentary</p>
<p>T</p> <p>Ø2.1</p> <p>Solder</p>	<p>1502 <small>HP rating N/A</small></p> <p>ON - OFF (momentary OFF)</p>	<p>V Curved Matt or gloss</p>
<p>U</p> <p>Ø2.1</p> <p>Right angle "T" solder terminal</p>	<p>1510 ♦ μ <small>HP rating N/A</small></p> <p>ON - ON</p>	<p>W Splashproof (with Arcshield) Matt</p>
<p>X</p> <p>4.0</p> <p>9.1</p> <p>PCB 0.8Sq* *N/A for 1300 series</p>	<p>1511 μ <small>HP rating N/A</small></p> <p>ON - ON (momentary 1 side)</p>	<p>X Two colour Matt ON - OFF only (not momentary)</p>
	<p>1520 ♦ μ <small>125V & 250V 1/2 HP H terminal rated T100 only</small></p> <p>ON - OFF - ON</p>	<p>F Flat lens Gloss (0430 only)</p>
	<p>1521 μ <small>HP rating N/A H terminal rated T100 only</small></p> <p>ON - OFF - ON (momentary 1 side)</p>	<p>A Softline lens Matt (0430 only) as F but with raised profile</p>
	<p>1522 μ <small>HP rating N/A H terminal rated T100 only</small></p> <p>ON - OFF - ON (momentary 2 sides)</p>	
	<p>0430 <small>X terminal N/A</small></p> <p>Indicator Technical data on page 66</p>	

Enhanced Splashproofing

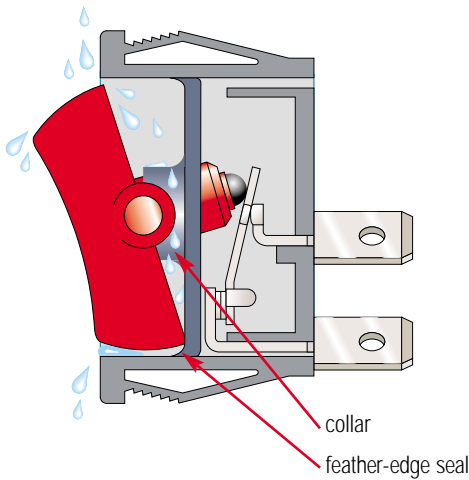

1500 W and B splashproof options

Feather edge seals and a close fitting collar protect current carrying parts from moisture.

B option has Hytrel collar/seals for enhanced protection.



C1500AR ---
T1500AR ---



C1500AL ---
T1500AL ---



C1500XL ---
T1500XL ---



C1510AL ---
T1510AL ---



C1520AL ---
T1520AL ---

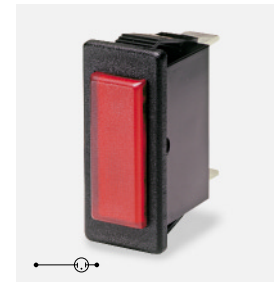

C0430AL ---
T0430AL ---

BODY

Panel cut-out * Flange
Cut-outs must be punched in the direction of insertion

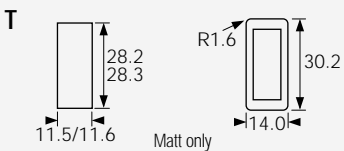
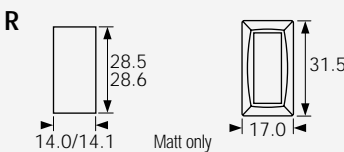
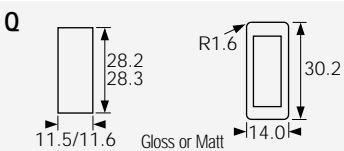
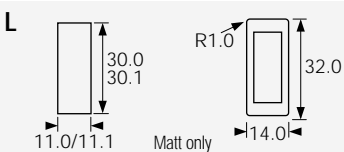
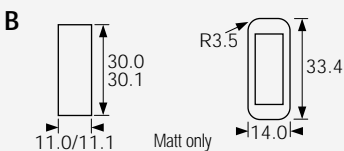
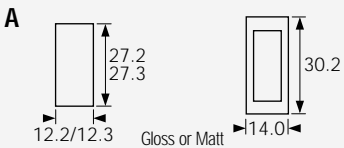

OPTIONS

- Finish** Matt is standard
- Colour** Call factory for custom colours. A full range is available for large orders
- Legend printing** Select from the examples or call factory for custom legends
- Lamp voltage** Call factory for details
- Blanking plates A0434** - - Dummy units to fill unused panel holes
- Protective cover** (designed to IP65) Snaps on to A, L, Q or T bodies (add G after body in cat no). This reduces panel thickness by 1mm.

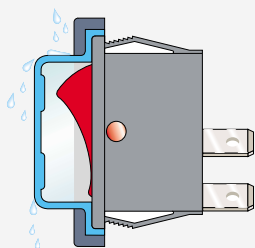

Panel sealing washer W46 is available for the same body sizes but reduces panel thickness by a further 0.8mm
Covers are not suitable for momentary types.

Arcshield
Hides switching arc

For all options call the factory

DIMENSIONS (mm)

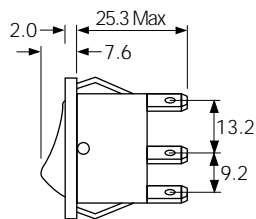

Panel thickness

- A,Q** 0.75 to 3.3mm
- L,B,T** 0.75 to 2.5mm
- R** 0.75 to 3.0mm

* For cut-out details on momentary switches call the factory

1300 High inrush, positive break switching

The 1300 series mechanism ensures contact welds formed at switch-on, are positively separated by the plunger tube acting directly on the step in the moving contact.

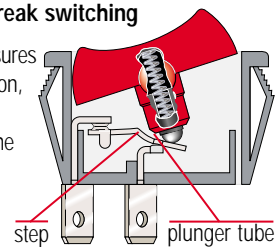

Examples of printing



EN602A



EN730



EN822

5500 Lit Rocker Switches - Single Pole 16A 250Vac



16(4)A 250Vac T85
10(3)A 250Vac T100, (12A 250Vac T125 for P rocker only)



UL CSA 15A 250Vac, CSA 16A Non Ind 250Vac
UL CSA 250Vac 1hp, 125Vac 1/2hp
UL 85°C, file E45221, CSA file LR10990

In house test

Inrush 24A to EN61058-1 & 20A 28Vdc

μ contact gap

Technical data on pages 4 & 5 (switches), 66 (indicators)

For Twin units repeat the order details for both the right and left sides

C 5503 A L ---

TERMINAL FUNCTION ROCKER BODY PRINT, COLOUR, VOLTAGE ETC

▶ TERMINAL	▶ FUNCTION		▶ ROCKER
<p>C</p> <p>6.3 x 0.8</p>	<p>Approvals & ratings vary with function On Off Switches - ON when pressed over terminal 3</p>		<p>A Softline (Matt only)</p>
<p>H</p> <p>4.8 x 0.8</p>	<p>5500 ♦ μ</p>	<p>ON - OFF</p>	
<p>T</p> <p>Solder</p>	<p>5503 ♦ μ preferred option</p>	<p>ON - OFF Lit Switched neutral</p>	<p>P Lit window (Matt only)</p>
	<p>5508 μ for special applications</p>	<p>ON - OFF Lit Unswitched neutral</p>	



C5503AL ---



C5500AL ---



C5503PL ---

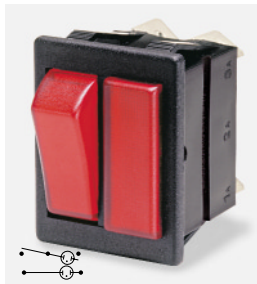

C5503A/C5430AL



C5503A/C5503AL



C5503P/C5503PL

BODY

Panel cut-out ** Flange
Cut-outs must be punched in the direction of insertion

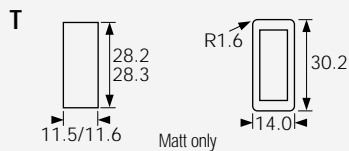
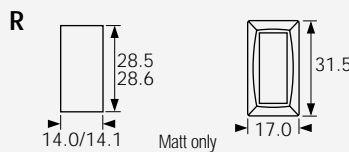
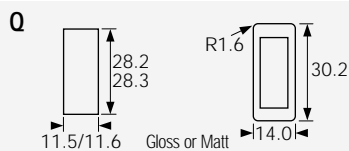
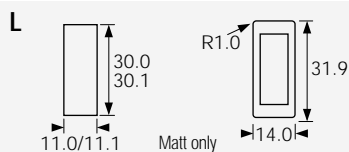
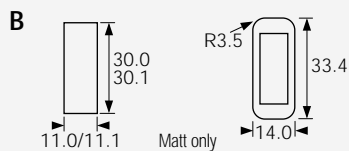
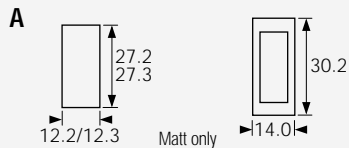

OPTIONS

Finish Matt is standard

Colour Call factory for custom colours. A full range is available for large orders

Legend printing Select from the examples or call factory for custom legends

Lamp voltage Call factory for details

Blanking plate A0434 --(SP) A0494 --(DP)
Dummy units to fill unused panel holes

Protective cover (designed to IP65)
Snaps on to A, L, Q or T bodies (add G after body in cat no). This reduces panel thickness by 1mm.

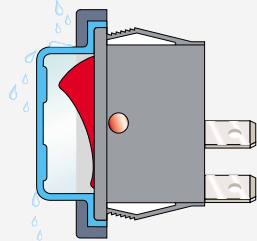

Panel sealing washers W46 (Single Pole) and W42 (Double Pole) are available for these body types but reduce panel thickness by a further 0.8mm

For all options call the factory

DIMENSIONS (mm)

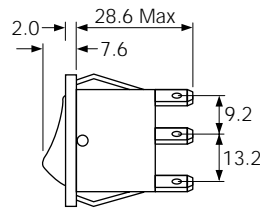

Terminal spacing - Poles 10.8 between centres (twin units)

Panel thickness

- A,Q** 0.75 to 3.3mm
- L,B,T** 0.75 to 2.5mm
- R** 0.75 to 3.0mm

** For cut-out details on momentary switches call the factory

Twin units

Two single switches or a switch and an indicator light can be assembled side by side in one double pole body. For 1500 range panel cut-out details see page 29. For 5500 range panel cut-out details (L, B and T) call factory.

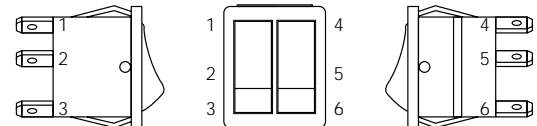

For twin units the first set of order format details refer to the left hand unit, when looking at the front of the assembly (This has terminal numbers 1, 2 & 3)

Examples of printing



EN3036

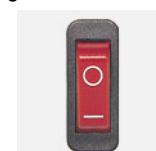

EN3064



EN706

6050 DP Splashproof Switches - IP44 & Twins[#] 16A 250Vac

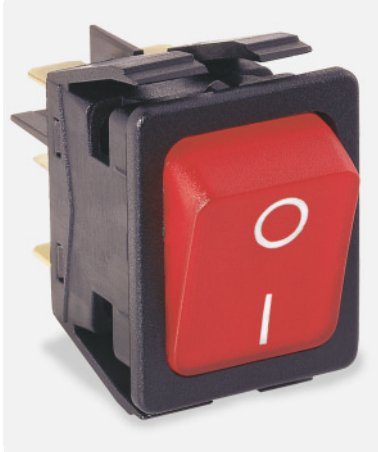

European 16(4)A 250Vac T125, 10A 400Vac T125



UL CSA 20A⁺ 277Vac, 277Vac 1hp, 125Vac 1/2hp
UL 100°C, file E45221, CSA file LR10990

In house test

Inrush 150A* to EN61058-1
8(8)A 250Vac T125 5E4 on 6050 only
20A 28Vdc

* * applies to non-momentary types

6050 Switches feature "Arcshield" to hide visible switching arc
3mm contact gap with Positive Break switching
Call factory for IP details on Twin units
Technical data on pages 4 & 5 (switches), 66 (indicators)
Patent app.

C 6053 A L ---

TERMINAL FUNCTION ROCKER BODY PRINT, COLOUR, VOLTAGE ETC

TERMINAL	FUNCTION	ROCKER
<p>C</p> <p>6.3 x 0.8</p>	<p>Approvals & ratings vary with function On Off Switches - ON when pressed over terminals 3 & 6</p>	<p>A Softline Matt</p>
	<p>6050 ON - OFF </p> <p>6051 ON - OFF (momentary ON) </p> <p>6052 ON - OFF (momentary OFF) </p>	<p>6060 ON - ON </p> <p>6061 ON - ON (momentary 1 side) </p> <p>6062 2 Circuit ON - ON <small>In house tests only</small> </p>
	<p>6053 ON - OFF Lit </p> <p>6054 ON - OFF (momentary ON) Lit </p> <p>6055 ON - OFF (Single pole) (momentary ON) Lit </p> <p>6056 ON - OFF (Single pole) Isolated light </p> <p>6057 ON - OFF Isolated light </p> <p>6058 ON - OFF (Single pole) Lit </p> <p>6059 ON - OFF (momentary ON) Isolated light </p>	<p>A Softline Matt</p> <p>Lit</p> <p>P Lit Window Matt</p> <p>Lit Window</p>
<p>H</p> <p>4.8 x 0.8</p>	<p>6066 ON - ON (Single pole) (isolated light) </p> <p>6067 ON - ON Lit </p> <p>6068 ON - ON 1pole ON - OFF Lit 1pole </p> <p>6090 ON - OFF 1pole ON - OFF Lit 1pole </p> <p>6091 ON - OFF (momentary ON) Lit </p> <p>6092 ON - OFF 1 pole ON - ON 1 pole </p>	
<p>S</p> <p>9.7</p> <p>Screw & Clamp N/A for assemblies with 3 terminals in either pole</p>	<p>Circuits are Double Pole unless described otherwise</p>	

For IP65 see "options" below

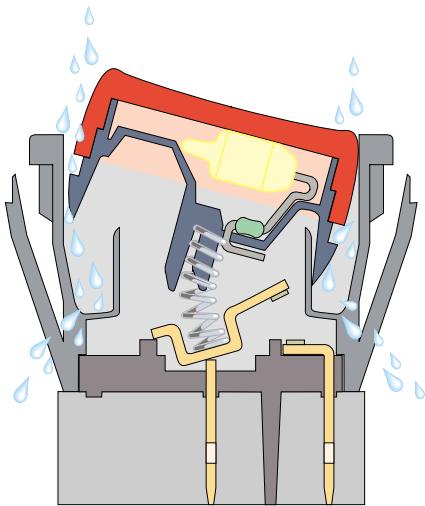

Splashproof to IP44

Current carrying parts are protected from moisture. Droplets which may enter the switch are channelled out through ports in the switch body



C6050AL ---



C6053AL ---

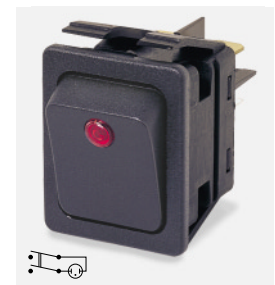

C6053PL ---



C6000A/C6000AL



C6003P/C6003PL

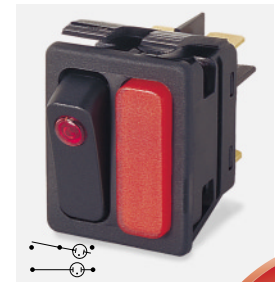

C6003P/C6030AL



BODY

Panel cut-out * Flange
Cut-outs must be punched in the direction of insertion

L Double pole

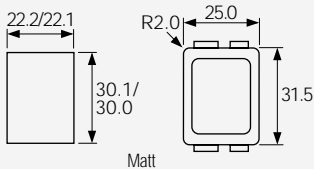

L Twin units

Contact factory for information on splashproofing and IP ratings

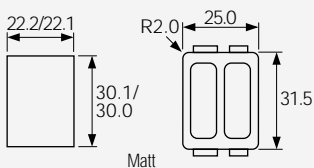

OPTIONS

Finish Matt is standard

Colour Call factory for custom colours. A full range is available for large orders

Legend printing Select from the examples or call factory for custom legends

Lamp voltage Call factory for details

Protective cover (designed to IP65 #)
The 6000 series is a water thru design. For a higher level of sealing, a snap on cover is available (add G after body code). This reduces panel thickness by 1mm.

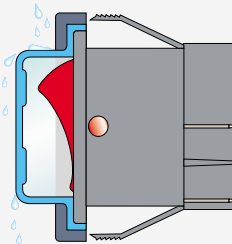

Panel sealing washer W42 is available but reduces panel thickness by a further 0.8mm. Covers are not suitable for momentary types.

IP Ratings Call the factory for details

Terminal Link P1067 connects the poles of a double pole switch or twin unit

Mounting orientation may affect IP rating

For all options call the factory

DIMENSIONS (mm)

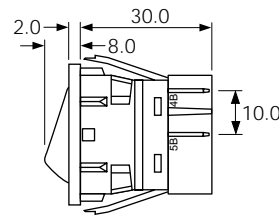

Terminal spacing - Poles 10.5 between centres

Panel thickness

L 0.75 to 3.0mm

* For cut-out details on momentary switches call the factory

*Twin units: 2 switches or indicators in one body
Repeat order details for both sides (left side first)
Call factory for IP details on Twin units
Circuits: refer to page 18*

Examples of printing



EN1196



EN1197

1550 Standard & 1350 Hi Inrush Switches 150A to IEC65 and 16A 250Vac



"Arcshield" feature hides visible switching arc



1550 Series 16(4)A 250Vac T125



UL CSA 16A 250Vac, (2 posn) 250Vac 1hp, 125Vac 1/2hp, (3 posn) 250 Vac 1/2hp, 125Vac 1/4hp. UL 85°C, file E45221, CSA file LR10990



Inrush 36A to EN61058-1 & 20A 28Vdc



1350 series 16(4)A 250Vac T85 1E4 (10,000 Ops.)

On request 16(6)A 250Vac T125 5E4 (50,000 Ops.) & 150A Inrush to IEC 65



UL CSA 20A 250Vac 1hp, 125Vac 1/2hp
UL 72Vdc 7A, 36Vdc 14A. UL 85°C, file E45221, CSA file LR10990



20A 28Vdc

3mm contact gap except if marked μ . Technical data on pages 4 & 5 (switches), 66 (indicators)

C 1553 A L ---

TERMINAL FUNCTION ROCKER BODY PRINT, COLOUR, VOLTAGE ETC

TERMINAL	FUNCTION	ROCKER
<p>C</p> <p>6.3 x 0.8</p>	<p>Approvals & ratings vary with function On Off Switches - ON when pressed over terminal 1</p>	<p>A Softline Matt</p> <p>Lit (not momentary)</p>
<p>H</p> <p>4.8 x 0.8*</p>	<p>Standard 1550 \blacklozenge</p> <p>Hi Inrush 1350 \blacklozenge</p> <p>ON - OFF</p>	<p>B Splashproof (with Arcshield)</p> <p>Matt or gloss</p> <p>Gloss only</p> <p>Lit (not momentary)</p>
<p>K</p> <p>2.8 x 0.8*</p>	<p>1551 μ HP rating N/A</p> <p>1552 μ HP rating N/A</p> <p>ON - OFF (momentary ON)</p> <p>ON - OFF (momentary OFF)</p>	<p>V Curved</p> <p>Matt or gloss</p> <p>Gloss only</p> <p>Lit (not momentary)</p>
<p>T</p> <p>Solder</p>	<p>1553 \blacklozenge Not W, X or B rocker</p> <p>1353 \blacklozenge Not W, X or B rocker</p> <p>ON - OFF Lit</p>	<p>W Splashproof (with Arcshield)</p> <p>Lit (not momentary)</p>
<p>U</p> <p>Right angle T Solder (Not DP)</p>	<p>1560 \blacklozenge μ</p> <p>1561 μ</p> <p>1562 μ In house tests only</p> <p>1570 \blacklozenge μ 125V & 250V 1/2 HP H terminal rated T100 only</p> <p>1571 μ HP rating N/A H terminal rated T100 only</p> <p>1572 μ HP rating N/A H terminal rated T100 only</p> <p>ON - ON</p> <p>ON - ON (momentary 1 side)</p> <p>2 Circuit ON - ON</p> <p>ON - OFF - ON</p> <p>ON - OFF - ON (momentary 1 side)</p>	<p>P Lit window Matt</p> <p>Lit (not momentary)</p> <p>X Two colour Matt</p> <p>(On Off only - not momentary)</p> <p>F Flat lens Gloss (0480 only)</p> <p>Lit (not momentary)</p>
<p>X</p> <p>PCB 0.8Sq*</p>	<p>1484 μ In-house tested to 10(3)A 250Vac</p> <p>1487 μ In-house tested to 10(3)A 250Vac</p> <p>0480 X terminal N/A</p> <p>3 position selective OFF - A - A+B</p> <p>3 position selective A - B - C (link not supplied)</p> <p>Indicator Technical data on page 66</p>	<p>A Softline lens Matt (0480 only) as F but with raised profile</p>

*Contact factory for details on 1350 series



C1350AL ---



C1550XL ---



C1553PL ---



C0480AL ---



Optional snap-in M441 barrier



C1553AA with M616 guard
Cut-out 22.0/22.1 x 29.4/29.5
Guard accepts "A" body only

BODY

Panel cut-out * Flange
Cut-outs must be punched in the direction of insertion

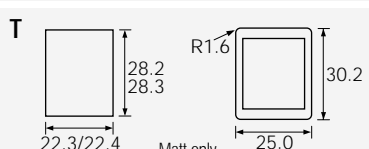
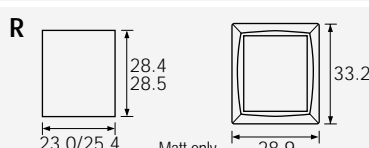
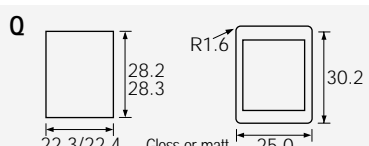
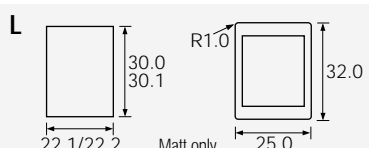
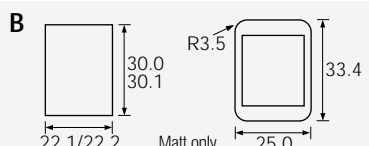
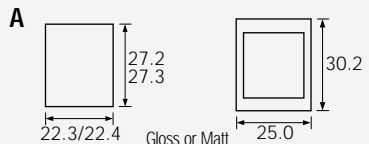

OPTIONS

Finish Matt is standard
Colour Call factory for custom colours. A full range is available for large orders
Legend printing Select from the examples or call factory for custom legends
Lamp voltage Call factory for details

Blanking plates A0494 Dummy units to fill unused panel holes

Protective cover (designed to IP65) Snaps on to A, L, Q or T bodies (add G after body in cat no). This reduces panel thickness by 1mm.

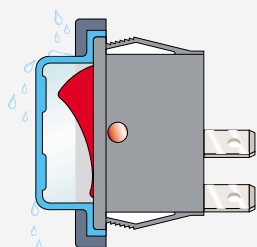

Panel sealing washer W42 is available for the above body sizes but reduces panel thickness by a further 0.8mm. Covers are not suitable for momentary types.

Arcshield
Hides switching arc

For all options call the factory

DIMENSIONS (mm)

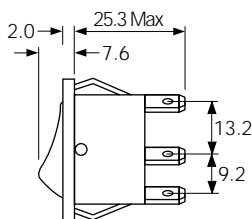

Terminal spacing - Poles 10.2 between centres

Panel thickness

- A,Q** 0.75 to 3.3mm
- L,B,T** 0.75 to 2.5mm
- R** 0.75 to 3.0mm

* For cut-out details on momentary switches call the factory

1350 High inrush, positive break switching

The 1350 series mechanism ensures contact welds formed at switch-on, are positively separated by the plunger tube acting directly on the step in the moving contact.

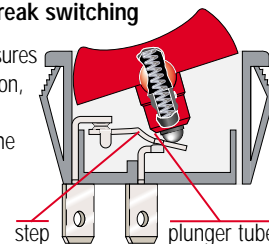

Examples of printing



EN602A



EN730



EN822

1500 Twin Units Switches and Indicators 16A 250Vac



16(4)A 250Vac T125



UL CSA 16A 250Vac

UL CSA (2 posn) 250Vac 1hp, 125Vac 1/2hp, (3 posn) 250 Vac 1/2hp, 125Vac 1/4hp
UL 85°C, file E45221, CSA file LR10990



Inrush 36A to EN61058-1 & 20A 28Vdc

For versions with High Inrush or for 50,000 operations, see pages 20 and 26
3mm contact gap except where marked μ
Technical data on pages 4 & 5 (switches), 66 (indicators)

For twin units repeat the order details for both the left and right sides

C 1500 A / C 1510 A L ---

TERMINAL FUNCTION ROCKER TERMINAL FUNCTION ROCKER BODY PRINT, COLOUR, ETC

TERMINAL	FUNCTION	ROCKER
<p>C</p> <p>6.3 x 0.8</p>	<p>Approvals & ratings vary with function On Off Switches - ON when pressed over terminal 1 or 4</p>	<p>A Softline (Matt)</p>
<p>H</p> <p>4.8 x 0.8</p>	<p>1500 ON - OFF</p>	<p>B Softline splashproof (Matt)</p>
<p>K</p> <p>2.8 x 0.8</p>	<p>1510 μ <small>HP rating N/A</small> ON - ON</p>	<p>W Curved splashproof (Matt)</p>
<p>T</p> <p>Solder</p>	<p>1520 μ <small>125V & 250V 1/2 HP, 125V H terminal rated T100 only</small> ON - OFF - ON</p>	<p>X Two colour (Matt) (not momentary) ON - OFF only</p>
<p>X</p> <p>PCB 0.8Sq</p>	<p>0430 <small>X terminal N/A</small> Indicator Technical data on page 66</p>	<p>A Softline lens (Matt) (Indicator)</p>

Enhanced Splashproofing

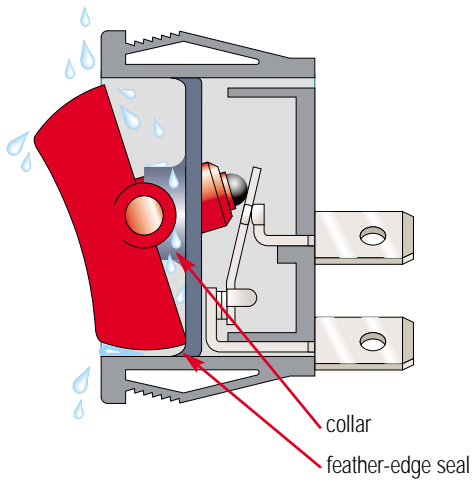

1500 W and B splashproof options

Feather edge seals and a close fitting collar protect current carrying parts from moisture.

B option has Hytrel collar/seals for enhanced protection.



C1500A/C1500AL



C1500A/C0430AL

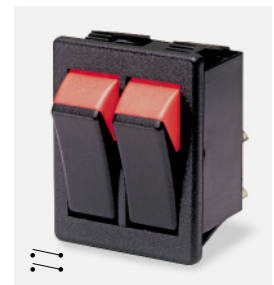

C1500X/C1500XL

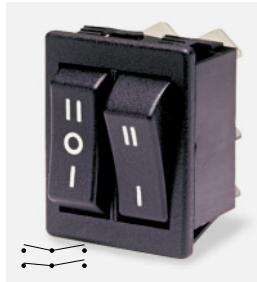

C1520A/C1510AL

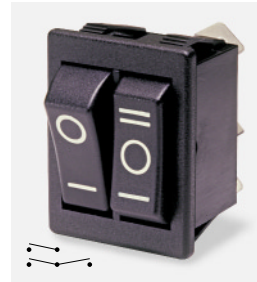

C1500A/C1520AL

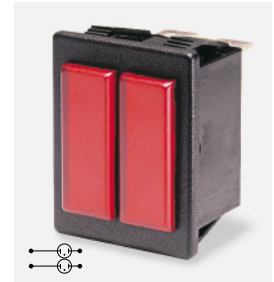

C0430A/C0430AL

BODY	
Panel cut-out *	Flange
Cut-outs must be punched in the direction of insertion	
A	
	Gloss or Matt
B	
	Matt only
L	
	Matt only
Q	
	Gloss or matt
R	
	Matt only
T	
	Matt only

OPTIONS	
Finish	Matt is standard
Colour	Call factory for custom colours. A full range is available for large orders
Legend printing	Call factory for custom legends. State if a legend is to appear on the right or left hand unit (viewed from the front)
Lamp voltage	Call factory for details
Arcshield	Hides switching arc

DIMENSIONS (mm)

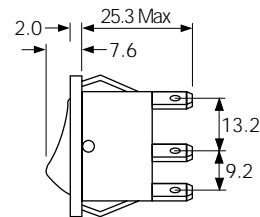

Call the factory for terminal spacing details

Panel thickness

A,Q	0.75 to 3.3mm
L,B,T	0.75 to 2.5mm
R	0.75 to 3.0mm

* For cut-out details on momentary switches call the factory

Twin unit terminal numbering

The first 6 digits of the catalogue number refer to the left hand unit when looking at the front. (This has terminal nos. 4, 5 & 6)

Examples of printing



EN602A



EN730

For all options call the factory

2000 Slide Switches - up to 5 position 10A 250Vac

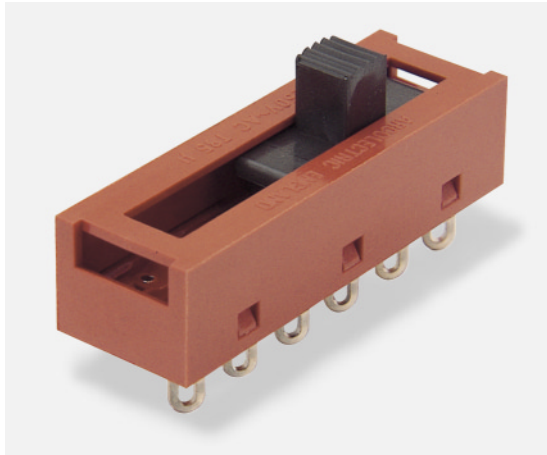

10A 250Vac T85
6(3)A 250Vac T85



UL CSA 16A 250Vac Non Inductive
UL CSA 4A 300Vac
UL65°C, file no. E45221, CSA file no. LR10990

μ contact gap

Please specify: Standard action (SP116) or Light action (SP118)
2000 series lubrication is inorganic and does not degrade plastics

Technical data on pages 4 & 5

T 2 2 20 5 C ---

TERMINAL SERIES POS'N POSITIONS CIRCUIT SLIDER BODY PRINT, COLOUR, ETC

TERMINAL	SERIES	POS'N	CIRCUIT	SLIDER			
K 2.8 x 0.8 R 2.8 x 0.8 T Solder X PCB 0.8 Sq. Y PCB 0.8 Sq. For mounting stability switches have extra "support" terminals * Nominal - Dimension varies with body type. For exact figure call factory	2	2 \blacklozenge Switching positions	10	0	6	D	L
			20	1	7	E	N
			30	2	9	G	P
			40	3	A	H	R
		3 \blacklozenge Switching positions	10	4	B	J	S
			20	5	C	K	T
			30				
			40				
		4 \blacklozenge Switching positions	10				
			20				
			30				
			40				
5 \blacklozenge Switching positions	10						
	20						
	30						
	40						

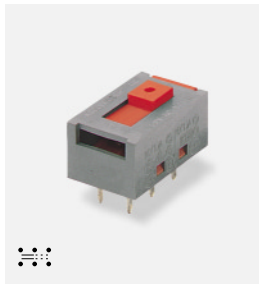

X22205C ---



T2220EC ---



T23206A ---



T24306A ---



T25302A ---



T25100A ---

BODY

C 2 positions

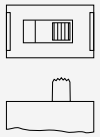

H 2 positions

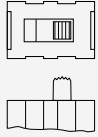

A 3 positions

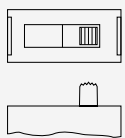

H 3 positions

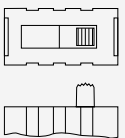

A 4 positions

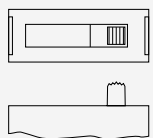

H 4 positions

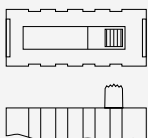

A 5 positions

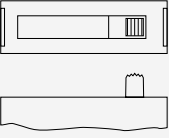

OPTIONS

Colour

For custom slider colours call the factory. A full range is available for large orders

DIMENSIONS (mm)

2 Position C body

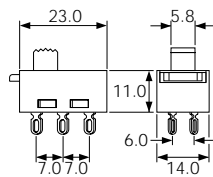

2 Position H body

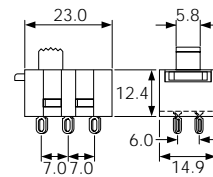

Cut-out/PCB Matrix

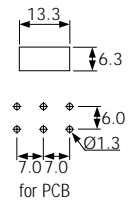

3 Position A body

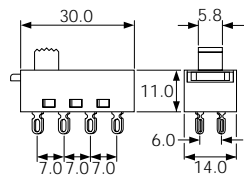

3 Position H body

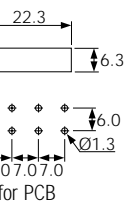
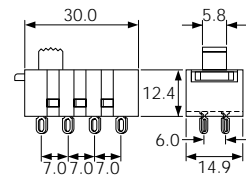

4 Position A body

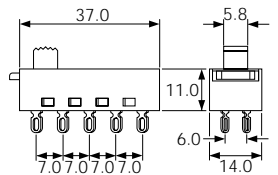

4 Position H body

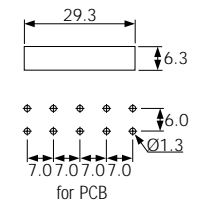
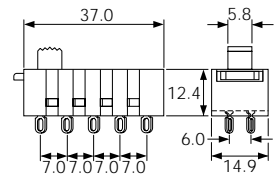

5 Position A body

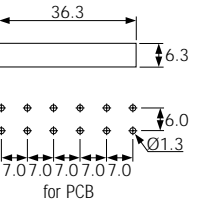
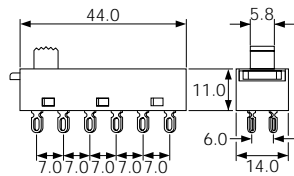

2000 Slide Switches - Snap-in & 2 hole fixing 10A 250Vac

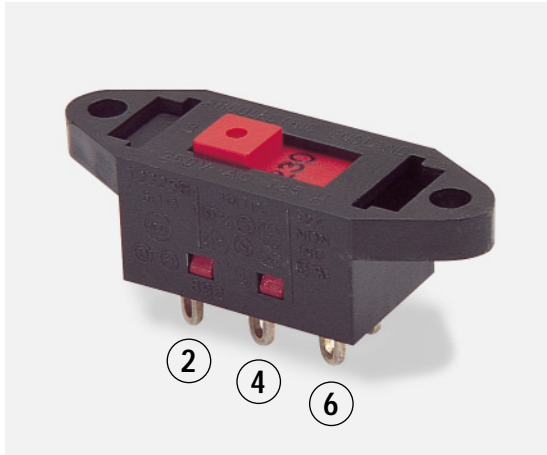

10 A 250Vac T85
6(3)A 250Vac T85



UL CSA 16A 250Vac Non Inductive
UL CSA 4A 300Vac
UL65°C, file no. E45221, CSA file no. LR10990

μ contact gap

Please specify: Standard action (SP116) or light action (SP118)
2000 series lubrication is inorganic and does not degrade plastics

Technical data on pages 4 & 5

115/230 is preferred legend

T 2 2 20 5 B ---

TERMINAL SERIES POSITIONS CIRCUIT SLIDER BODY PRINT, COLOUR, ETC

TERMINAL	SERIES	POS'N	CIRCUIT	SLIDER								
K 2.8 x 0.8	2	2	10 	0 2 Pos B Body only 	6 2 & 3 Pos B Body only 	C E Body & 2 & 3 Pos B Body only 	L 2 & 3 Pos B Body only Limited travel on 2 pos 	S Limited travel on 2 pos 2 & 3 Pos B Body only 				
			20 	2 2 Pos B Body only 	7 2 & 3 Pos B Body only 	D 2 & 3 Pos B Body only 	M F Body only Legend optional 	T 2 & 3 Pos B Body only 				
			30 	3 2 & 3 Pos B Body only 	8 E Body only Legend optional 	E 2 Pos B Body only Limited travel on 2 pos 	N 2 Pos B Body only 					
			40 	4 2 & 3 Pos B Body only 	9 2 & 3 Pos B Body only 	H 2 Pos B Body only 	P 2 & 3 Pos B Body only Limited travel on 2 pos 					
R 2.8 x 0.8	2	2	10 	5 2 Pos B Body only Also with legend 	A 2 Pos B Body only 	K 2 & 3 Pos B Body only Limited travel on 2 pos 	R 2 & 3 Pos B Body only 					
			20 	58Sq 								
			30 									
			40 									
T Solder	2	2	10 									
			20 									
			30 									
			40 									
X PCB 0.8 Sq. For mounting stability switches have extra "support" terminals * Nominal - Dimension varies with body type. For exact figure call factory	2	3	10 									
			20 									
			30 									
			40 									



T22208E ---



T22308E ---



T2230MF ---



T22205B ---



T22305B ---



T23204B ---

BODY

B With fixing holes

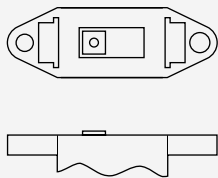

E Snap-in

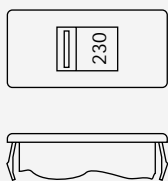

Cut-outs must be punched in the direction of insertion

F Snap-in (single pole ON OFF only)

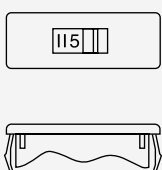

Cut-outs must be punched in the direction of insertion

OPTIONS

Colour
For custom slider colours call the factory. A full range is available for large orders

Standard body colour is black

Legend printing
A wide range is available

For all options call the factory

DIMENSIONS (mm)

2 Pos B

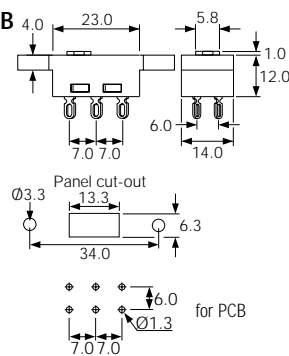

Cut-out / PCB Matrix

3 Pos B

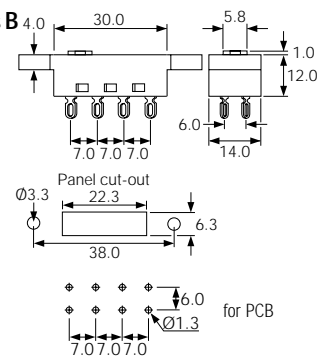

2 Pos E

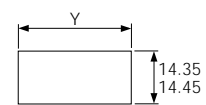
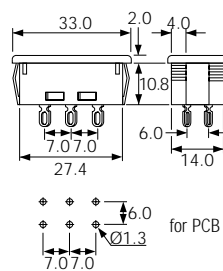

Panel thickness	Dim. Y
0.8-1.2	29.75/29.85
1.63	30.15/30.25
2.0	30.35/30.45
2.5	30.55/30.65

2 Pos F

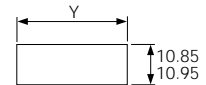
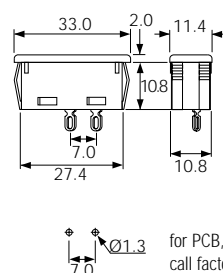

Panel thickness	Dim. Y
0.8-1.2	29.75/29.85
1.63	30.15/30.25
2.0	30.35/30.45
2.5	30.55/30.65

8300 Push Button Switches 16A 250Vac



NEW



16(4)A 250Vac T85, 1E4 (10,000 Operations)
 12(2)A 250Vac T105, 1E4 (10,000 Operations)
 8(8)A 250Vac T105, 5E4 (50,000 Operations)
 6(6)A 250Vac T125, 5E4 (50,000 Operations)



12A 250Vac DP, 13A 250Vac SP
 250Vac 1hp, 125Vac 1/2hp
 UL 85°C, file E45221, CSA file LR10990

3mm contact gap
 Technical data on pages 4 & 5

H 8353 J E ---

 TERMINAL FUNCTION ACTUATOR BODY PRINT, COLOUR, ETC

TERMINAL	FUNCTION	ACTUATOR
<p>C</p> <p>6.3 x 0.8 10.1</p>	<p>Approvals & ratings vary with function Single pole switches use terminals 1 & 2 (& 3)</p>	<p>A Standard actuator</p>
<p>H</p> <p>4.8 x 0.8 8.5</p>	<p>8300 ♦ ON - OFF Single pole</p>	<p>D Custom profile actuator</p>
<p>A</p> <p>7.7</p> <p>As "H" but right angle 4.8 x 0.8</p>	<p>8301 ♦ ON - OFF (momentary ON) Single pole</p>	<p>H Slotted for custom actuators Slots for snap-in buttons</p>
<p>K</p> <p>2.6 2.8 x 0.8 8.5</p>	<p>8303 ♦ ON - OFF with light Single pole</p>	<p>C Square lens</p>
<p>T</p> <p>2.6 2.8 x 0.8 7.0</p> <p>Solder</p>	<p>8304 ♦ ON - OFF (momentary ON) with light Single pole</p>	<p>E Radiused actuator</p>
<p>X</p> <p>4.5 0.8 7.0</p> <p>PCB 0.8 Sq</p>	<p>8350 ♦ ON - OFF Double pole</p>	<p>F Small round actuator</p>
<p>V</p> <p>3.7 0.8 4.3</p> <p>Dual pin PCB (Call factory for matrix dims)</p>	<p>8351 ♦ ON - OFF (momentary ON) Double pole</p>	<p>J Smooth curved actuator</p>
	<p>8353 ♦ ON - OFF with light Double pole</p>	
	<p>8354 ♦ ON - OFF (momentary ON) with light Double pole</p>	<p>All actuators except D & H available lit</p>



C8350AB ---
T8350AB ---



H8353JE ---
T8353JE ---

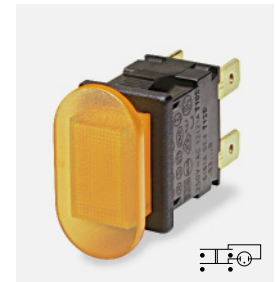

H8353EB ---
T8353EB ---

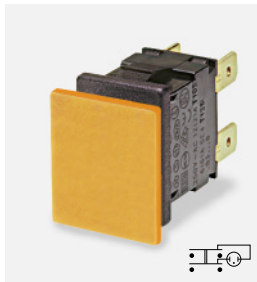

H8353CB ---
T8353CB ---



H8350DB ---
T8350DB ---

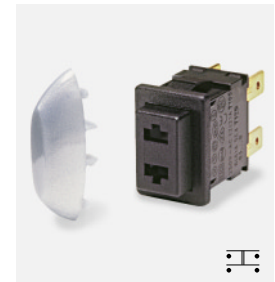

H8350HB ---
Example of actuator

BODY

Panel cut-out Flange
Cut-outs must be punched in the direction of insertion

- B** Standard body
- D** As B body but with PCB support peg
- E** Softline style body with radiused bezel
- F** As E body but with PCB support peg

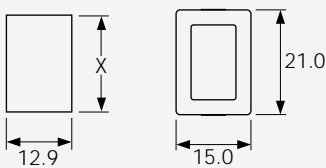

Dimensions for snap-in fixing

Panel thickness	Dimension X
0.75-1.24	19.1/19.2
1.25-1.99	19.3/19.4
2.00-3.00	19.7/19.8

OPTIONS

Finish
Matt finish standard except on J and D actuators which are gloss

Colour
Call factory for custom colours
A full range is available for large orders

Legend printing
Select from the examples or call factory for custom legends

Special buttons
Some of the many options are shown
Call the factory for the full range

L167 Protective cover
(designed to IP65)



Snaps on to switch bodies fitted with "A" or "J" style actuators but reduces panel thickness by 0.8mm

DIMENSIONS (mm)

**Actuator A
Body B**

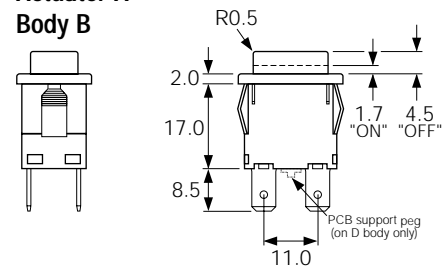

**Actuator J
Body E**

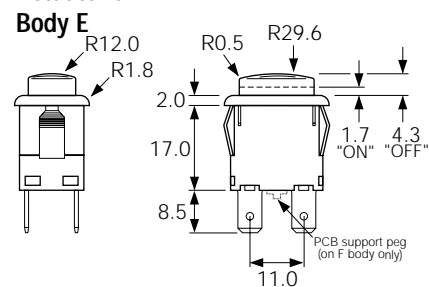

Spacing between centre of terminals 1 & 3 or 2 & 4 is 10.0mm

Examples of printing



EN1153



EN1152

8200 Push Button Switches 16A 250Vac

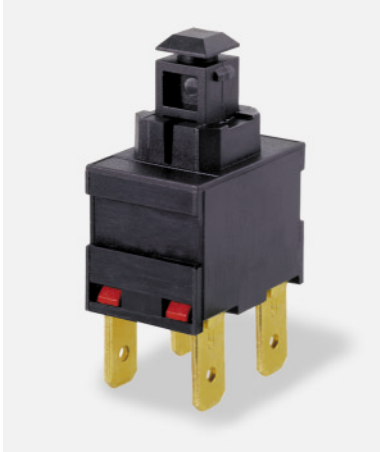

16(4)A 250Vac T85, 1E4 (10,000 Operations)
 12(2)A 250Vac T105, 1E4 (10,000 Operations)
 8(8)A 250Vac T105, 5E4 (50,000 Operations)
 6(6)A 250Vac T125, 5E4 (50,000 Operations)



12A 250Vac
 250Vac 1hp, 125Vac 1/2hp
 UL 85°C, file E45221, CSA file LR10990

3mm contact gap
 Technical data on pages 4 & 5

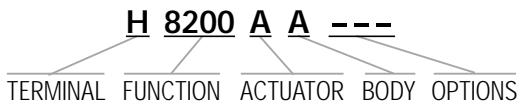

TERMINAL	FUNCTION	ACTUATOR
<p>C</p> <p>6.3 x 0.8</p>		<p>A Standard actuator for snap-on custom adaptors</p>
<p>H</p> <p>4.8 x 0.8</p> <p>A</p> <p>As H, 4.8 x 0.8 Right angle</p>	<p>8200 ON - OFF Single pole</p>	<p>B Flat top actuator</p>
<p>K</p> <p>2.8 x 0.8</p>	<p>8201 ON - OFF (momentary ON) Single pole</p>	<p>C Curved top actuator</p>
<p>T</p> <p>1.5</p> <p>Solder</p>	<p>8250 ON - OFF Double pole</p>	<p>NEW</p> <p>Examples of possible actuation methods</p> <p>Using a Snap on adaptor</p>
<p>X</p> <p>PCB 0.8 Sq</p> <p>V</p> <p>3.7 Ctrs</p> <p>Dual pin PCB 0.8 Sq (Call factory for matrix dims)</p>	<p>8251 ON - OFF (momentary ON) Double pole</p>	<p>Using a Hinged Actuator</p>
<p>M</p> <p>5.3</p> <p>As V, PCB but Right angle</p>		

Alternative Actuator

Impact washer resists damage from excessive operator force

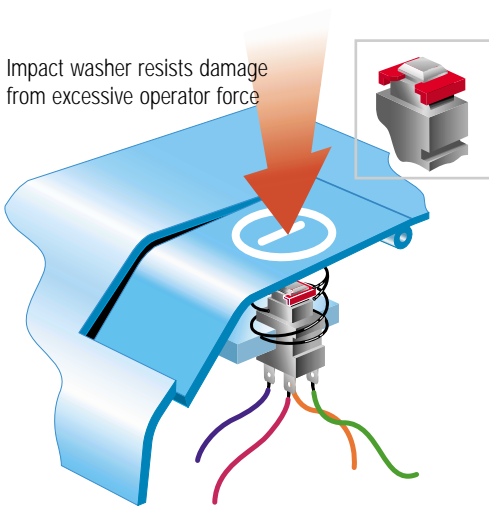

C8250AA ---
with impact washer M1226



X8201AA ---

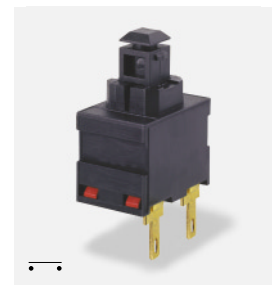

K8200AA ---



A8200AA ---



M8200AC ---



Example of M8200AC

BODY

A Standard body

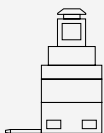

See dimensioned drawings for details

C As standard body but with side support peg for use with M PCB terminals

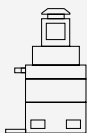

See dimensioned drawings for details

D As standard 'A' body but with base support peg for use with V PCB terminals



See dimensioned drawings 'A' for details

DIMENSIONS (mm)

'A' body with 'H' 4.8 terminals

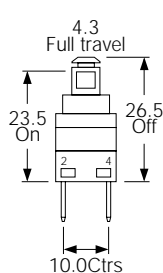
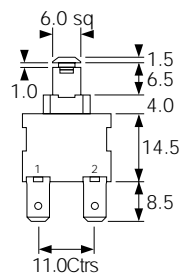
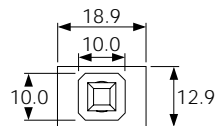

'A' body with 'A' right angle 4.8 terminals

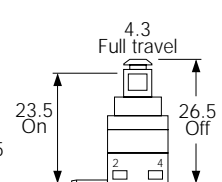
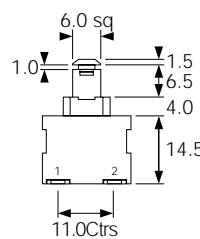
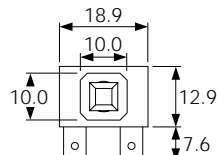

'C' body with 'M' right angle PCB terminals

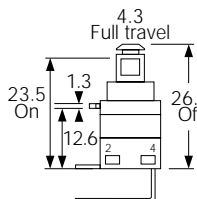
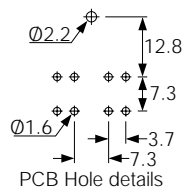
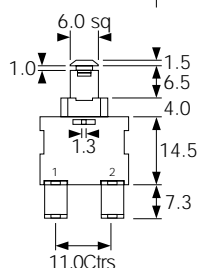
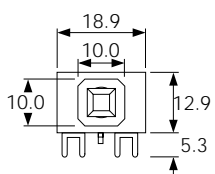

Example of possible mounting styles

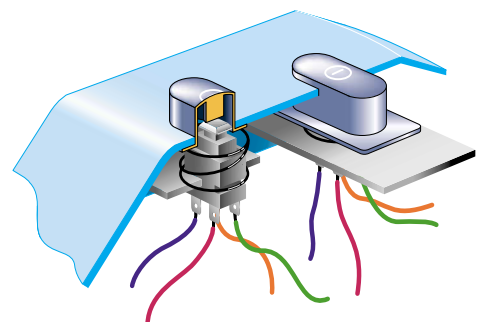

7000 Push Button Switches 16A 250Vac



16(4)A 250Vac T125
8(8)A 250Vac T85



UL CSA 16A Non Ind, 250Vac 1hp, 125Vac 1/2hp
UL65°C, file no. E45221, CSA file no. LR10990



Inrush 35A to EN61058-1 & 16A 28V dc

3mm contact gap

Technical data on pages 4 & 5 (switches), 66 (indicators)

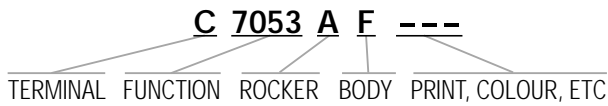

TERMINAL	FUNCTION			ACTUATOR	
C 6.3 x 0.8 9.1	7000		Single pole ON - OFF	A Round actuator shown in F body 	
	7001		Single pole ON - OFF (momentary ON)		
	7003		Single pole ON - OFF with light	A Round actuator shown in G body 	
	7004		Single pole ON - OFF (momentary On) with light		
	7050		Double pole ON - OFF		
	H 4.8 x 0.8 9.1	7051		Double pole ON - OFF (momentary On)	S Rectangular actuator Shown in "A" body N/A for 7030
		7053		Double pole ON - OFF with light	
7054			Double pole ON - OFF (momentary On) with light		
7030			Indicator		
7030			Indicator		



C7000AF ---



C7001AF ---



C7003AF ---

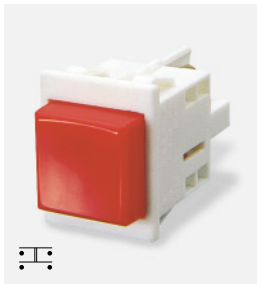

C7050SA ---



C7053AG ---



C7030AH ---

BODY

Panel cut-outs

F H G Body types fit either cut-out

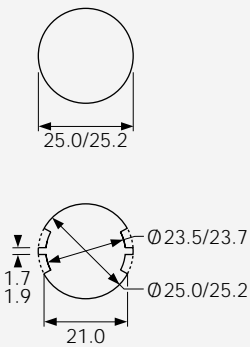

A

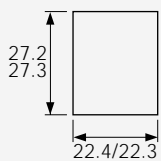

Cut-outs must be punched in the direction of insertion

OPTIONS

Finish

Matt finish is standard on bodies
Gloss finish is standard on actuators

Colour

Call factory for custom colours
A full range is available for large orders

Legend printing

A wide range is available or call the factory for custom legends

Lamp voltage

Call factory for details of other available voltages

Protective housing (E)

(designed to IP65)
Covers are available for round body styles, call factory for details

DIMENSIONS (mm)

Panel thickness:

A 0.8 - 2.5mm
F,G,H 0.8 - 5.0mm

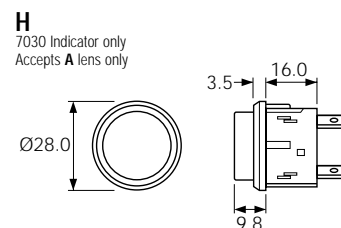
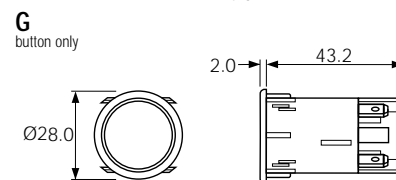
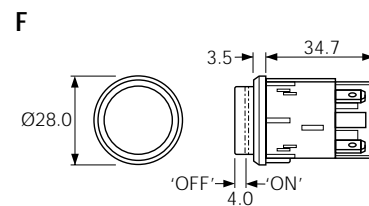
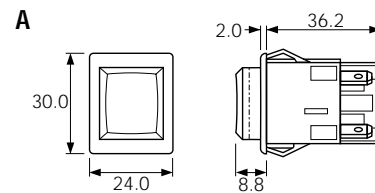

1100 Push Button Switches 0.125A 125Vac



UL 0.125A 125Vac
UL 0.125A 45Vdc
UL file E45221

In house test 0.5A 250Vac T85 5E4 (50,000 Operations)

μ contact gap
Technical data on pages 4 & 5



T1100AA ---



T1101AA ---

T 1100 A A - - -

TERMINAL FUNCTION ACTUATOR BODY OPTIONS

TERMINAL	FUNCTION	ACTUATOR	BODY
T 2.8 x 0.5	 1100 ◆ ON - OFF (alternate) Single pole	A Actuator without button 	A For purpose designed facias and sub-panels B Snap-in fixing Panel thickness 0.75-1.24 1.25-1.99 2.00-3.00 Dimension X 19.1/19.2 19.3/19.4 19.7/19.8
	1101 ◆ ON - OFF (momentary ON) Single pole	B Softline button 	C 2 Hole fixing Ø3.1 7.0 Min 5.0 Min

Dimensions (mm)

T1100AA (Enclosure mounting)

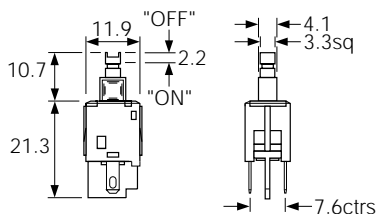

T1100AC (2 Hole Fixing) No.4 self-tapping screws

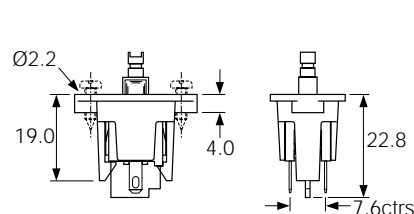

T1100BB (Snap-in) Cut-outs must be punched in the direction of insertion

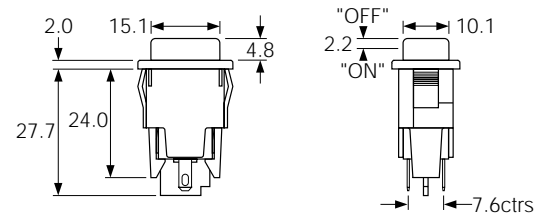

0916 - 0920 Push Button Switches 0.5A 250Vac

Self-Wiping - Slow Make & Break

In house test 0.5A 250Vac T85

μ contact gap
Technical data on pages 4 & 5



T0916SO--- & T0916LO---

T0916VA---

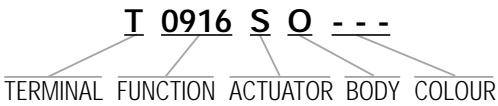

TERMINAL	FUNCTION	ACTUATOR	BODY	OPTIONS
T Solder	0916 Black base SP ON-OFF (momentary ON)	S Small Actuator 	O for L and S Actuator Panel Cut-out Panel thickness Both nuts - 2.5mm No backnut - 4.0mm	Finish Gloss finish for L and S actuators Colour Call factory for custom colours A full range is available for large orders
	0917 50V only Brown base SP ON-ON (momentary 1 side)	L Large Actuator 		
	0918 White base SP ON-OFF (momentary OFF)	V Vandal Resistant IP66 Flat top Stainless steel 	A for V Actuator (stainless steel) Chamfer profile bezel Panel Cut-out Panel thickness - 8.0mm	
	0919 Black base SP ON-ON (momentary 1 side)			
	0920 White base DP ON-OFF (momentary ON)			

Dimensions (mm)

Nylon S and L actuators

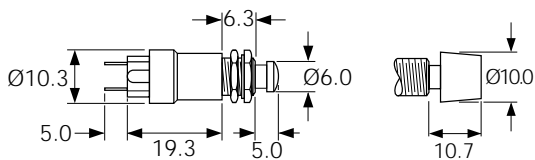

Neck thread - 40 TPI Whit. Actuator travel - 2.5 max

Stainless steel V actuator (IP66)

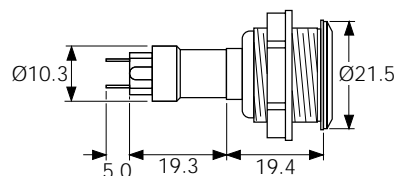

Neck thread - 26 TPI Whit. Actuator travel - 2.5 max

0910 - 0911 Push Button Snap Action Switches 15(4)A 250Vac



15(4)A 250Vac T85

UL 15A, 1/2hp 125-250Vac 85°C,
UL file E91973, CSA file LR98589

Approvals apply to switch mechanism only (34340350COL000)
μ contact gap
Full rating details and technical data on pages 50 & 51
Ratings are at full plunger travel



C0911KB ---



C0911VA ---



C0911RB ---



C0911PB ---



C0911EB ---

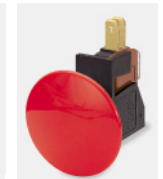

C0911BB ---

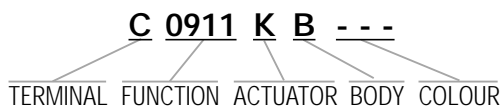

TERMINAL	FUNCTION	ACTUATOR	BODY	OPTIONS
<p>C</p> <p>6.3 x 0.8</p>	<p>0910</p> <p>ON - ON (alternate)</p> <p>0910 is available with K and N actuators only</p> <p>0911</p> <p>ON - ON (momentary)</p>	<p>R Rectangular bezel</p> <p>B Large Contact factory for details</p> <p>E Long</p> <p>P Short</p> <p>K with satin chrome bezel</p> <p>N with nylon bezel</p> <p>V Vandal resistant (911 only)</p>	<p>B</p> <p>N/A for V Actuator</p> <p>Panel Cut-out</p> <p>Panel thickness Both nuts 2.5mm No backnut 4.0mm</p> <p>A</p> <p>Stainless steel chamfer profile bezel for V actuator only</p> <p>Panel Cut-out</p> <p>Panel thickness 8.0mm</p>	<p>Colour</p> <p>Call factory for custom colours A full range is available for large orders</p> <p>Cover M323</p> <p>Available for "P" actuator only</p> <p>Covers have internal nylon nut</p>

Dimensions (mm)

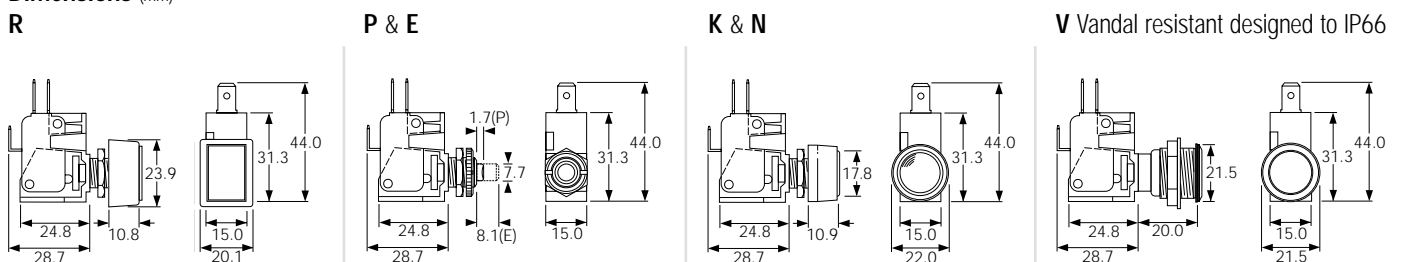

1900 Vandal Resistant Switches - Designed to IP66



6A 250Vac T85 25E3
 2A 250Vac T85 50E3*
 6A 250Vac T85
 UL file no. E91973

Approvals apply to switch mechanism only
 μ contact gap
 Ratings shown are at full plunger travel
 Switching mechanisms are snap action (not sealed)
 Actuator and bezel are stainless steel
 *See rating details and technical data on pages 48 & 49

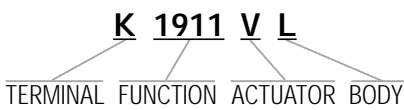

TERMINAL	FUNCTION	ACTUATOR	BODY
K 2.8 x 0.5 7.9	1911 ON - ON (momentary 1 side) Single pole	V Flat top (stainless steel)	A Stainless steel Chamfer profile bezel Ø19.2 Panel thickness up to 4.0mm
T 1.14 x 2.54 3.4 Solder	1961 ON - ON (momentary 1 side) Double pole		L Stainless steel Chamfer profile bezel Ø16.0 Panel thickness up to 4.0mm
X 4.57 x 5.3 PCB			

Dimensions (mm)

Single pole (K1911VA shown)

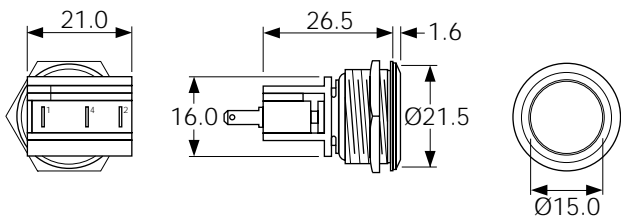

Double pole (K1961VL shown)

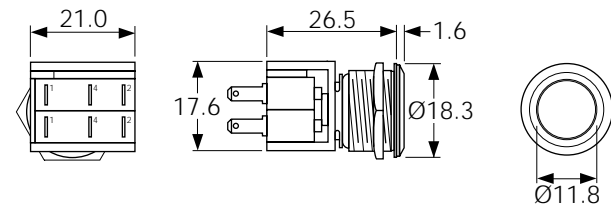

8300 Vandal Resistant Switches - Designed to IP66



16(4)A 250Vac T85, 1E4 (10,000 Operations)
 12(2)A 250Vac T105, 1E4 (10,000 Operations)
 8(8)A 250Vac T105, 5E4 (50,000 Operations)
 6(6)A 250Vac T125, 5E4 (50,000 Operations)



12A 250Vac DP, 13A 250Vac SP
 250Vac 1hp, 125Vac 1/2hp
 UL 85°C, file E45221, CSA file LR10990

3mm contact gap
 Technical data on pages 4 & 5
 Switching mechanism not sealed

NEW



H8300RP ---

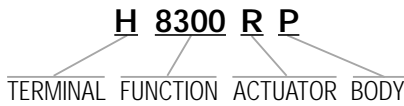

TERMINAL	FUNCTION	ACTUATOR	BODY
<p>C</p> <p>6.3 x 0.8</p> <p>H</p> <p>4.8 x 0.8</p>	<p>8300</p> <p>ON - OFF (alternate) Single pole</p>	<p>R</p> <p>Raised top (stainless steel)</p>	<p>P</p> <p>Stainless steel Soft profile bezel</p> <p>Panel thickness 0.75 - 3.0mm</p> <p>For details of alternative panel cut-out and bezel diameters, call the factory</p>
<p>K</p> <p>2.6 1.5 Solder</p> <p>T</p> <p>2.6 1.5 Solder</p>	<p>8301</p> <p>ON - OFF (momentary ON) Single pole</p>		
<p>V</p> <p>3.7Ctrs Dual pin PCB</p> <p>X</p> <p>4.5 7.0 0.8Sq PCB</p>	<p>8350</p> <p>ON - OFF (alternate) Double pole</p>		
	<p>8351</p> <p>ON - OFF (momentary ON) Double pole</p>		

Dimensions (mm)

8300RP (H terminals shown)

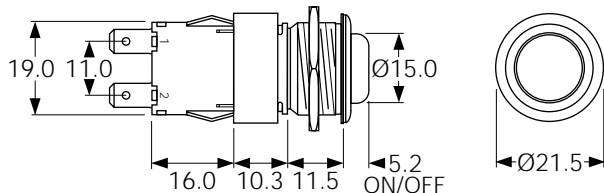

0911 Vandal Resistant Switches - Designed to IP66



16(4)A 250Vac T85

UL 16A, 1/2hp 125-250Vac 85°C,
UL file E91973, CSA file LR98589

Approvals apply to switch mechanism only (34340350C0L000)
μ contact gap
Full rating details and technical data on pages 50 & 51
Ratings are at full plunger travel



↑ C0911VA ---

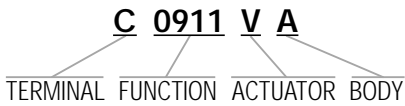

▶ TERMINAL	▶ FUNCTION	▶ ACTUATOR	▶ BODY
<p>C</p> <p>6.3 x 0.8</p>	<p>0911</p> <p>ON - ON (momentary 1 side)</p>	<p>V Flat top (stainless steel)</p>	<p>A Stainless steel Chamfer profile bezel</p> <p>Panel thickness up to 8.0mm</p>

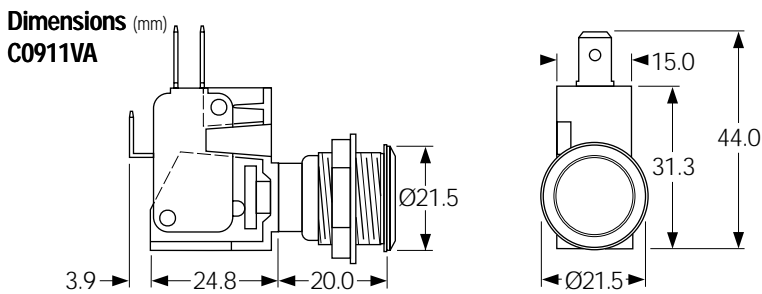

04102 Push Button Switches 16(4)A 250Vac

 **D** 16(4)A 250Vac T85 (10,000 operations)

Snap action normally open or closed switching
 Large overtravel allows actuator / button tolerance
 Button shape allows operation by hinged actuators

μ contact gap
 UL94 V1 Button and body
 Complies with UL Glow wire test - 850°C Cat D



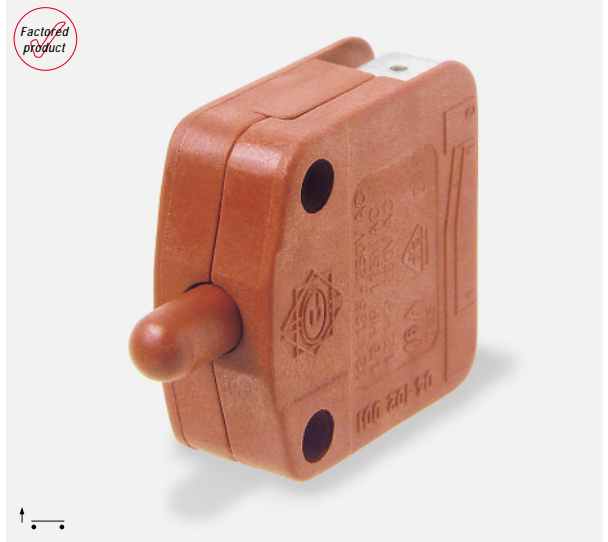

Additional technical data on pages 4 & 5

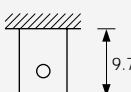

 04102-001

04102-001

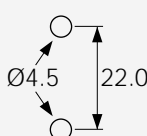
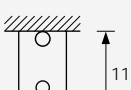
TERMINAL FUNCTION ACTUATOR BODY

TERMINAL	FUNCTION	ACTUATOR	BODY
 <p>6.3 x 0.8</p> <p>Force when applying connectors ≤80N</p>	<p>04102-001</p>  <p>Single Pole ON-OFF (momentary ON)</p>	 <p>(Off) 15.0 (Mom On) 12.4 (Full Travel) 8.0</p>	<p>2 Hole fixing</p>  <p>Ø4.5 22.0</p> <p>(shakeproof washers not to be used with fixings)</p>
 <p>6.3 x 0.8</p> <p>Force when applying connectors ≤80N</p>	<p>04102-001R</p>  <p>Single Pole ON-OFF (momentary OFF)</p>	 <p>(On) 15.2 (Mom Off) 13.0 (Full Travel) 8.2</p>	<p>(shakeproof washers not to be used with fixings)</p>

Dimensions (mm)

04102-001

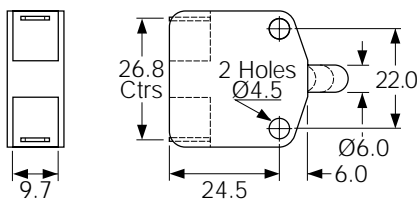

04102-001R

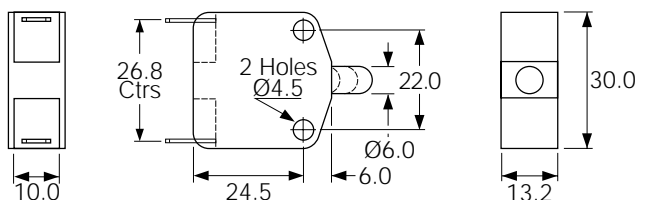

0936 - 0938 Push Button Switches 0.5A 250Vac

In house test 0.5A 250Vac
In house test 0.25A 250Vdc

μ contact gap
 Technical data on pages 4 & 5



C0936PC - - -



C0938MA - - -

C 0936 P A - - -

TERMINAL FUNCTION ACTUATOR BODY OPTION

▶ TERMINAL	▶ FUNCTION	▶ ACTUATOR	▶ BODY	▶ OPTIONS
C 6.3 x 0.8	0936 ON - OFF (momentary ON)	P Small round push K satin chrome bezel M moulded nylon bezel both with large round push	C Nylon top plate and fixing neck Back nut must be fitted A Metal top plate and fixing neck For Low Voltage (up to 50V) only Back nut must be fitted	Push button finish Gloss finish only Push button colour Red, black for other colours call the factory Cover M327 Available for "P" actuator
	0938 ON - OFF (momentary OFF)	 Specify Satin chrome or nylon (black / white) bezel	 Back nut must be fitted	Covers have internal nylon nut

Dimensions (mm) 0936 / 0938 P

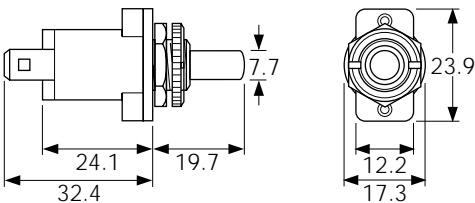

0936 / 0938 K / M

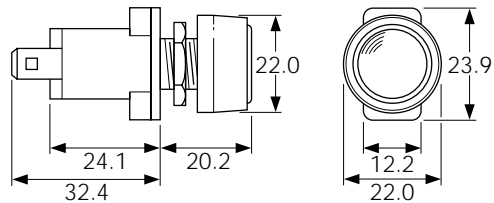

290 Series V4 Snap-action Switches Up to 6A 250Vac



NEW



6A 250Vac T85 25E3 - *150g
2A 250Vac T85 50E3 - *60g



6A 250Vac T85 - *150g
2A 250Vac T85 - *60g
UL file no. E91973 ** Operating force

Ratings shown are at full plunger travel
μ contact gap



For sealed snap-action switches contact the factory

29 1 20 150 CO L002

SERIES TERMINAL CONTACT GAP OPERATING FORCE FUNCTION ACTUATOR

SERIES	TERMINAL	CONTACT GAP	OPERATING FORCE	FUNCTION
29	<p>1</p> <p>2.8 x 0.5</p>	20 (0.5 mm)	gms	<p>CO ON - (ON) (momentary 1 side)</p>
	<p>2</p> <p>Solder</p>		60	
	<p>3</p> <p>PCB</p>		150	
	<p>4</p> <p>LH PCB</p>			
	<p>5</p> <p>RH PCB</p>			
	Viewed from plunger end			



293 20 150 CO L000



291 20 60 CO - - - -



294 20 150 CO 0000



292 20 150 CO R000



291 20 150 CO R001



292 20 150 CO 0000

ACTUATOR

No lever
0000

Plain lever
L000
L001
L002

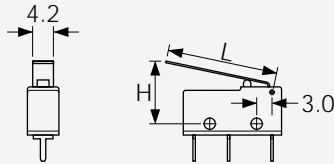

Roller lever
R000
R001
R002

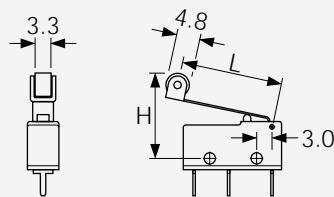

	L000	L001	L002	R000	R001	R002
Dim H	12.23	15.19	19.93	16.97	19.93	24.66
Dim L	17.5	30.0	50.0	15.91	28.41	48.41

Many alternative actuators are available from fully adjustable tooling
Contact factory for details

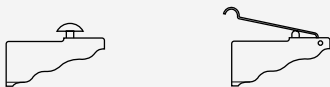

DIMENSIONS (mm)

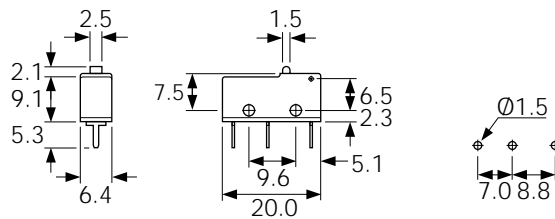

TECHNICAL DATA

Mechanical life	>5 million operations
Temperature rating	T85°C
Insulation	>1,250V
Tracking resistance	PTI KB 250

MECHANICAL DATA

High at rest point**	8.92
Trip point**	8.16-8.54
Pre-travel	0.38-0.76
Movement differential	0.15 (max)
Overtravel	0.6 (min)

Operating force (nominal)	Release force (min)
60g	10g
150g	50g

**Measured from fixing hole centres to top of plunger

MATERIALS

Body, lid & Plunger	Glass-filled nylon 6.6, VO
Plunger	Glass-filled nylon 6.6, VO
Terminals	Brass
Moving contact arm	Phosphor bronze
Spring	Stainless steel
Contacts	Fine silver
Actuator/roller	Stainless steel/acetal

340 & 390 Series V3 Snap-action Switches Up to 25(4)A 250Vac



340 Series

16(4)A 250Vac T85 50E3 **16A 125/250Vac 1/2hp T85***350g All functions
 16(4)A 250Vac T85 25E3 **16A 125/250Vac 1/2hp T85***120g All functions
 10(4)A 250Vac T85 25E3 **10A 125/250Vac 1/4hp T85*** 75g All functions

390 Series

25(4)A 250Vac T85 50E3 **22A 125/250Vac 1hp T85***350g NO or NC
 22(4)A 250Vac T85 50E3 **22A 125/250Vac 1hp T85***120g NO or NC
 20(4)A 250Vac T85 10E3 **20A 125/250Vac 1hp T85***350g CO
 16(4)A 250Vac T85 50E3 **16A 125/250Vac 1/2hp T85***120g CO





UL file no. E91973

*Operating force

Ratings shown are at full plunger travel
 μ contact gap

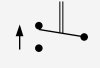
34 3 40 350 NO ZDSO

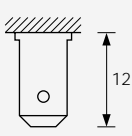
SERIES TERMINAL CONTACT GAP OPERATING FORCE FUNCTION ACTUATOR

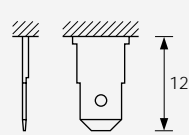
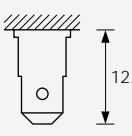
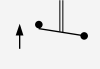
SERIES	TERMINAL	CONTACT GAP	OPERATING FORCE	FUNCTION	
34 (See ratings above for 340 Series)	2  Solder (34 Series) Both end terminals shown	40 (1.0 mm)	Operating force in gms 075 (34 Series only)	 CO ON - (ON) (momentary 1 side)	
	2  Solder (39 Series)				
39 (See ratings above for 390 Series)	3  6.3 x 0.8 (34 & 39 Series)		40 (1.0 mm)	120 (34 & 39 Series)	 NO (ON) - OFF (momentary On)
	5  4.8 x 0.5 (34 Series)				
	6  4.8 x 0.8 (34 Series)	350 (34 & 39 Series)		 NC ON - (OFF) (momentary Off)	



343 40 120 CO ZDS1



342 40 120 CO ZD01

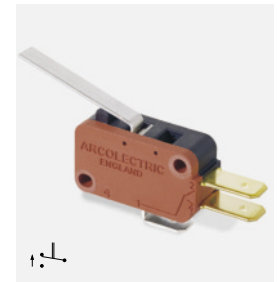

343 40 075 CO - - - -



346 40 350 NC - - - -



346 40 120 NO - - - -



343 40 120 CO L000

ACTUATOR

No lever
L000

Plain lever
ZD00
ZD01
ZD02

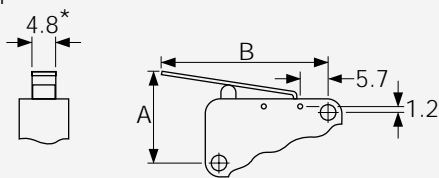

* 7.0 & 9.5mm wide levers also available - contact factory

Roller lever
ZDS0
ZDS1

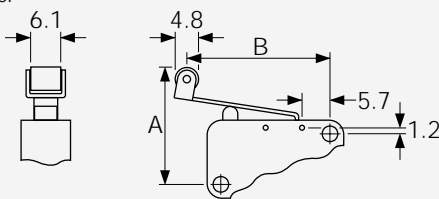

	ZD00	ZD01	ZD02	ZDS0	ZDS1
Dim A	17.0	18.6	25.8	22.2	23.9
Dim B	22.6	33.9	84.4	19.7	31.7

Many alternative actuators are available from fully adjustable tooling.
Contact factory for details

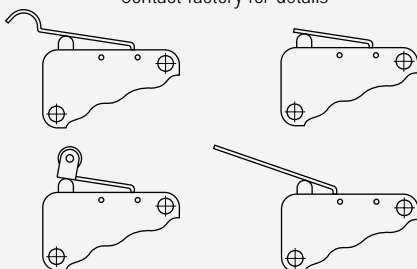

DIMENSIONS (mm) (3 terminals shown)

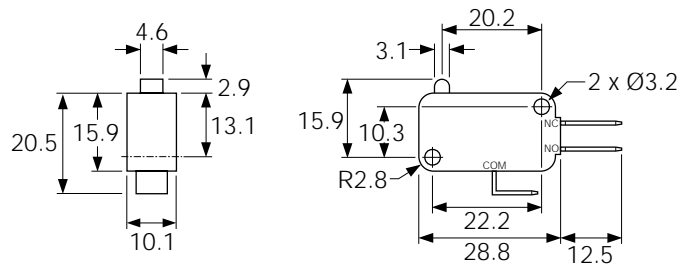

TECHNICAL DATA

Mechanical life	>10 million operations
Temperature rating	T85°C
Insulation	>1,250V
Tracking resistance	PTI KB 300

MECHANICAL DATA

High at rest point**	15.93
Trip point**	14.4-15.17
Pre-travel	0.76-1.52
Movement differential	0.25 (max)
Overtravel	1.32 (min)

Operating force (nominal)	Release force (min)
75g	25g
120g	40g
350g	100g

**Measured from lower hole centre to top of plunger.

MATERIALS

Body, lid & Plunger	Glass-filled nylon 6.6, VO
Terminals	Brass (silver plated for solder) - 34 Series Brass silver plated - 39 Series
Rocker arm	Brass silver plated
Moving contact	Phosphor bronze silver plated
Spring	Beryllium copper
Contacts	Fine silver (34 Series), silver cadmium oxide (39 Series)
Actuator/roller	Stainless steel/acetel
Dummy contacts	Glass-filled nylon 6.6, VO

Safety Cut-out Switches 16A 250Vac



C0320AA
16.1A 250Vac



C0320BB
16(4)A 250Vac 1/2hp







μ contact gap
These safety switches are assembled with snap-action switches shown on pages 50 and 51
Technical data, alternative ratings and approvals are listed on the above pages

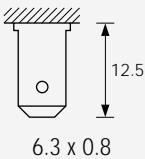

Safety requirements for Portable Heaters can be met by the fitting of a safety cut-out switch
The heater will then turn off if overturned

C0320AA - - -

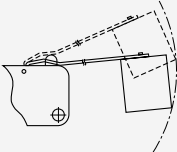
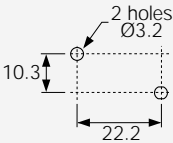
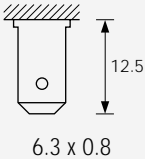
TERMINAL FUNCTION ACTUATOR MOUNTING

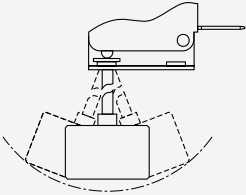
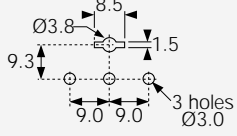
ORDER CODE	TERMINAL	FUNCTION	ACTUATOR	MOUNTING
C0320AA		 ON - OFF (momentary OFF)		
C0320BB		 ON - OFF (momentary OFF)		

Dimensions (mm) (for assemblies fitted with 340 & 390 series switches)

C0320AA

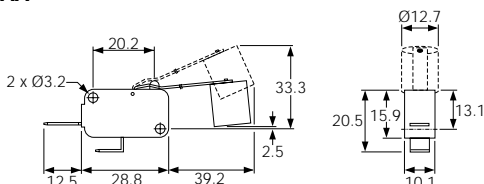

C0320BB

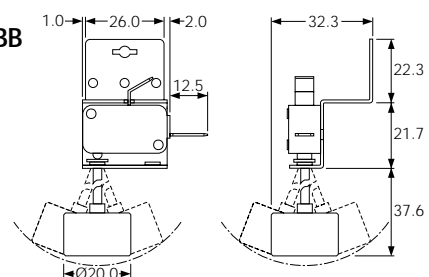

0305 Combined Switch / Lampholder for Freezers



2A 250Vac 25 T 85



UL15W 125/250Vac
UL 65°C, file E116391

For approval status on versions
0306 and 0308 call the factory
Switched units have μ contact gap
Technical data on pages 4 & 5

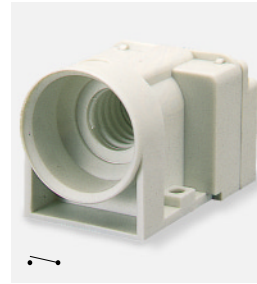

C0305RT - - -

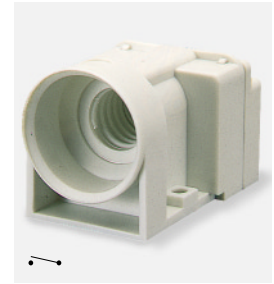

C0305LT - - -

C 0305 R T - - -

TERMINAL FUNCTION MOUNTING BODY COLOUR, ETC

▶ TERMINAL	▶ FUNCTION	▶ MOUNTING	▶ BODY	▶ OPTIONS
<p>C</p> <p>6.3 x 0.8</p>	<p>0305 (E14)</p> <p>ON - OFF Switch and Lampholder</p> <p>0306 (E12)</p> <p>ON - OFF Switch and Lampholder</p>	<p>L</p> <p>For Left hinged lid for 0305/0306 switches not for 0307 lampholders</p> <p>View from bulb end</p>	<p>T</p> <p>Body without flange for 0305/0306 switches</p> <p>Top view</p>	<p>Colour</p> <p>Call factory for colours. A full range is available for large orders</p>
<p>H</p> <p>4.8 x 0.8</p>	<p>0307 (E14)</p> <p>Lampholder only (No Switch)</p> <p>0308 (E12)</p> <p>Lampholder only (No Switch)</p>	<p>R</p> <p>For Right hinged lid for 0307 lampholders or 0305/0306 switches</p> <p>View from bulb end</p>	<p>S</p> <p>Body with rear flange for 0307 lampholders and for 0305/0306 switches</p> <p>Top view</p>	

Dimensions (mm) and Properties

The mechanism of this switch/lampholder does not contain mercury and may be safely used in food storage equipment. When fitted to the lid of a freezer storage cabinet, the switch will operate the lamp when the lid is opened to the angle of tilt shown in the drawing.

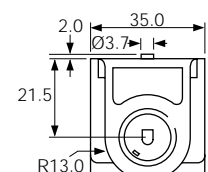
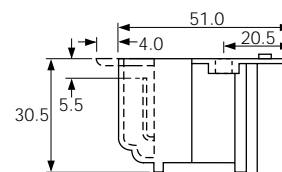

0055 Refrigerator Door Switches



0055 & 0056
2(0.2)A 250Vac 25T125 5E4
(50,000 operations)

μ contact gap

Technical data on pages 4 & 5



C0055RB ---



C0056RB ---

C 0055 R B - - -

TERMINAL FUNCTION ACTUATOR BODY COLOUR, ETC

▶ TERMINAL	▶ FUNCTION	▶ ACTUATOR	▶ BODY	▶ OPTIONS
<p>C</p> <p>6.3 x 0.8</p>	<p>0055</p> <p>ON - OFF (momentary OFF)</p>	<p>R</p>	<p>B</p> <p>Panel cut-out</p> <p>Panel thickness</p> <p>0055 1.0 - 1.6 0056 1.0 - 2.6</p>	<p>Finish Gloss finish only</p> <p>Colour White is standard</p> <p>Call factory for custom colours</p>
<p>H (0056 only)</p> <p>4.8 x 0.8</p>	<p>0056</p> <p>ON - OFF (momentary OFF)</p>		<p>Flange</p>	

Dimensions (mm)

C0055RB

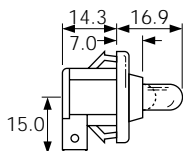

C0056RB

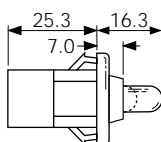

3005 Refrigerator Door Switches *Splashproof*



3005 25W 25T85 5E4 (50,000 Operations) 250Vac
 3006 65W 25T85 5E4 (50,000 Operations) 250Vac

These products require 3mm minimum actuator stroke to ensure switch action and rating above

μ contact gap
 Technical data on pages 4 & 5



C3005CB ---



C3005BL ---

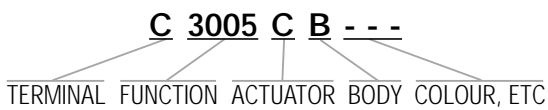

TERMINAL	FUNCTION	ACTUATOR	BODY	OPTIONS
C 6.3 x 0.8	3005 ON - OFF (momentary OFF) 1mm max travel to OFF position	B 26.0	3005 or 3006 Terminal direction (viewed from hinge end) Panel cut-out: 25.4/25.5, 12.1/12.2 Flange: 30.2, 14.0	Finish Gloss finish only Colour White is standard Call factory for custom colours A full range is available for large orders
H 4.8 x 0.8	3006 ON - OFF (momentary ON) 3mm min travel to ON position	C 13.0	3005 only Terminal direction (viewed from hinge end) Panel cut-out: 25.4/25.5, 12.1/12.2 Flange: 30.2, 18.0	

Dimensions (mm) (C terminals shown)

3005

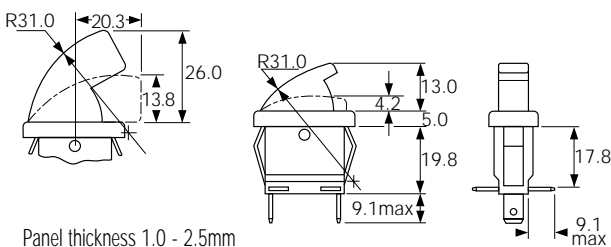

3006

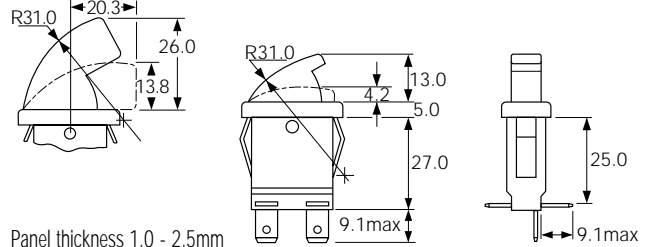

3100 Refrigerator Door Switches *Splashproof*



5A 250Vac 25T85 5E4 (50,000 Operations)



UL CSA 5A 250Vac
UL 85°C, file E45221, CSA file LR10990



200W 250Vac Lampload (400,000 operations)

μ contact gap
Technical data on pages 4 & 5
Sealed terminals option available. Call factory for details



E3102AA - - -



E3111BA - - -

E 3102 A A - - -

TERMINAL FUNCTION ACTUATOR BODY COLOUR, ETC

▶ TERMINAL	▶ FUNCTION	▶ ACTUATOR	▶ BODY	▶ OPTIONS
<p>E</p> <p>4.8 x 0.5</p> <p>For sealed terminals call the factory</p>	<p>3101</p> <p>ON - OFF (momentary ON)</p> <p>3102</p> <p>ON - OFF (momentary OFF)</p> <p>3111</p> <p>ON - ON (momentary 1 side)</p>	<p>A</p> <p>B</p> <p>C</p> <p>D</p> <p>E</p>	<p>A</p> <p>Panel cut-out Panel thickness 1.0 - 2.5mm</p>	<p>Finish Gloss finish only</p> <p>Colour White is standard</p> <p>Call factory for custom colours A full range is available for large orders</p>

Dimensions (mm) (*A* actuator shown)

- 3101 uses terminals 1,2
- 3102 uses terminals 1,2
- 3111 uses terminals 1,2,3

For details of actuator travel and switching angles call the factory

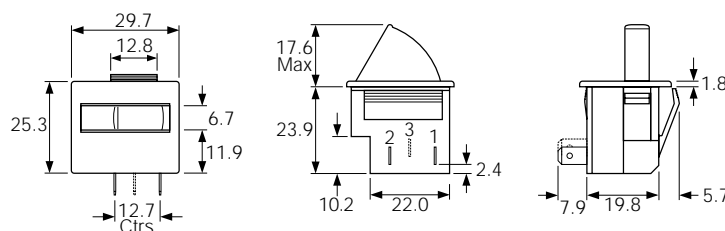

3140 Refrigerator Door Switches *Splashproof*



5A 250Vac 25T85 5E4 (50,000 Operations)



UL CSA 5A 250Vac
UL 85°C, file E45221, CSA file LR10990

In house test 200W 250Vac Lampload (400,000 operations)

3mm contact gap
Technical data on pages 4 & 5
Sealed terminals option available. Call factory for details

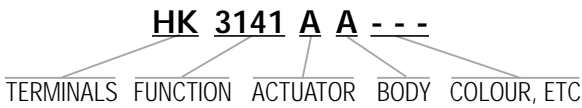
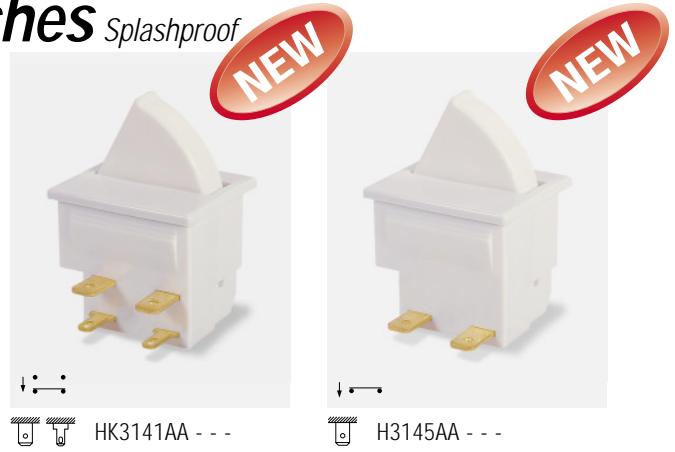

▶ TERMINAL	▶ FUNCTION	▶ ACTUATOR	▶ BODY	▶ OPTIONS
<p>H</p> <p>4.8 x 0.8</p> <p>Standard format is H terminals in positions 1 & 2 and K terminals in positions 3 & 4</p> <p>For sealed terminals call the factory</p>	<p>3141</p> <p>ON - ON (momentary)</p> <p>3145</p> <p>ON - OFF (momentary OFF)</p> <p>3146</p> <p>ON - OFF (momentary ON)</p>	<p>A</p> <p>B</p> <p>C</p> <p>D</p> <p>E</p>	<p>A</p> <p>Optional cut-out for orientation</p> <p>Panel cut-out Panel thickness 1.0 - 2.5mm</p>	<p>Finish Gloss finish only</p> <p>Colour White is standard</p> <p>Call factory for custom colours A full range is available for large orders</p>

Dimensions (mm) ("A" actuator shown)

3141 uses terminals 1,2,3,4

3145 uses terminals 3,4

3146 uses terminals 1,2

For details of actuator travel and switching angles call the factory

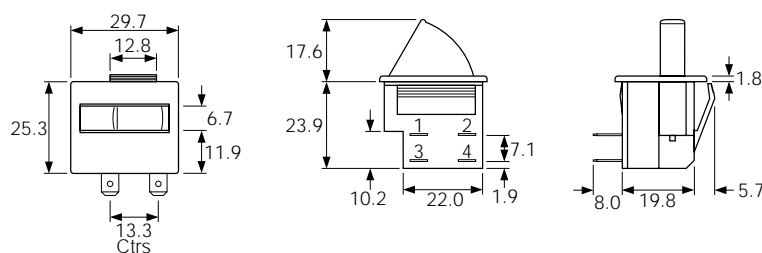

9100 Rotary Switches 16A 250Vac

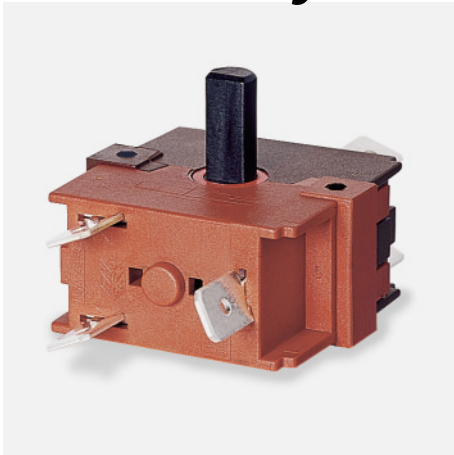

16(4)A 250Vac T125
16A 400Vac T125
8(8)A 250Vac T125 5E4 (50,000 Operations)



UL CSA 20A Non Ind 277Vac, 250Vac 2hp, 125Vac 1hp
UL85°C, file no. E45221, CSA file no. LR10990



20A 28V dc

9100 switches are highly versatile with up to 6 positions at 30° intervals and 6 terminals per switch. For more complex switching (7 positions & over), contact the factory. Two switches may be stacked to give up to 12 terminal switching.

Custom spindles of any length, with or without a "D" flat, can be produced from our infinitely variable tooling. The flat can be at any angle.

3mm contact gap
Technical data on pages 4 & 5

C 9 5 01 D A

TERMINAL SERIES POSITIONS CIRCUIT SPINDLE BODY

TERMINAL	SERIES	POSITION	CIRCUIT	SPINDLE																								
<p>C</p> <p>6.3 x 0.8</p>	9	<p>2</p> <p>Switching positions</p>	<p>9100 switches offer almost infinite switching options</p> <p>For this reason it is impractical to show all the options available</p> <p>The table below gives an example of a 5 position switching sequence: OFF, 1, 1+2, 1+2+3, 1+2+3+4</p> <table border="1"> <thead> <tr> <th>Off</th> <th>Pos 1</th> <th>Pos 2</th> <th>Pos 3</th> <th>Pos 4</th> <th>Pos 5</th> </tr> </thead> <tbody> <tr> <td></td> <td></td> <td></td> <td></td> <td></td> <td></td> </tr> <tr> <td>A</td> <td></td> <td></td> <td></td> <td></td> <td></td> </tr> <tr> <td>B</td> <td></td> <td></td> <td></td> <td></td> <td></td> </tr> </tbody> </table>	Off	Pos 1	Pos 2	Pos 3	Pos 4	Pos 5							A						B						<p>A</p> <p>B</p> <p>C</p> <p>D</p> <p>M</p> <p>N</p> <p>P</p> <p>R</p> <p>S</p> <p>L</p> <p>supplied without spindle</p>
Off		Pos 1		Pos 2	Pos 3	Pos 4	Pos 5																					
A																												
B																												
<p>H</p> <p>4.8 x 0.8</p> <p>For approval information on H terminals, contact the factory</p> <p>Simple circuits may not use all terminals. Unnecessary terminals may be omitted.</p>		<p>3</p> <p>Switching positions</p>		<p>4</p> <p>Switching positions</p>	<p>5</p> <p>Switching positions</p> <p>Use the blank table to plan your switching up to 6 positions</p> <table border="1"> <thead> <tr> <th>Pos 1</th> <th>Pos 2</th> <th>Pos 3</th> <th>Pos 4</th> <th>Pos 5</th> <th>Pos 6</th> </tr> </thead> <tbody> <tr> <td></td> <td></td> <td></td> <td></td> <td></td> <td></td> </tr> <tr> <td>A</td> <td></td> <td></td> <td></td> <td></td> <td></td> </tr> <tr> <td>B</td> <td></td> <td></td> <td></td> <td></td> <td></td> </tr> </tbody> </table>	Pos 1	Pos 2	Pos 3	Pos 4	Pos 5	Pos 6							A						B				
Pos 1	Pos 2	Pos 3	Pos 4	Pos 5	Pos 6																							
A																												
B																												

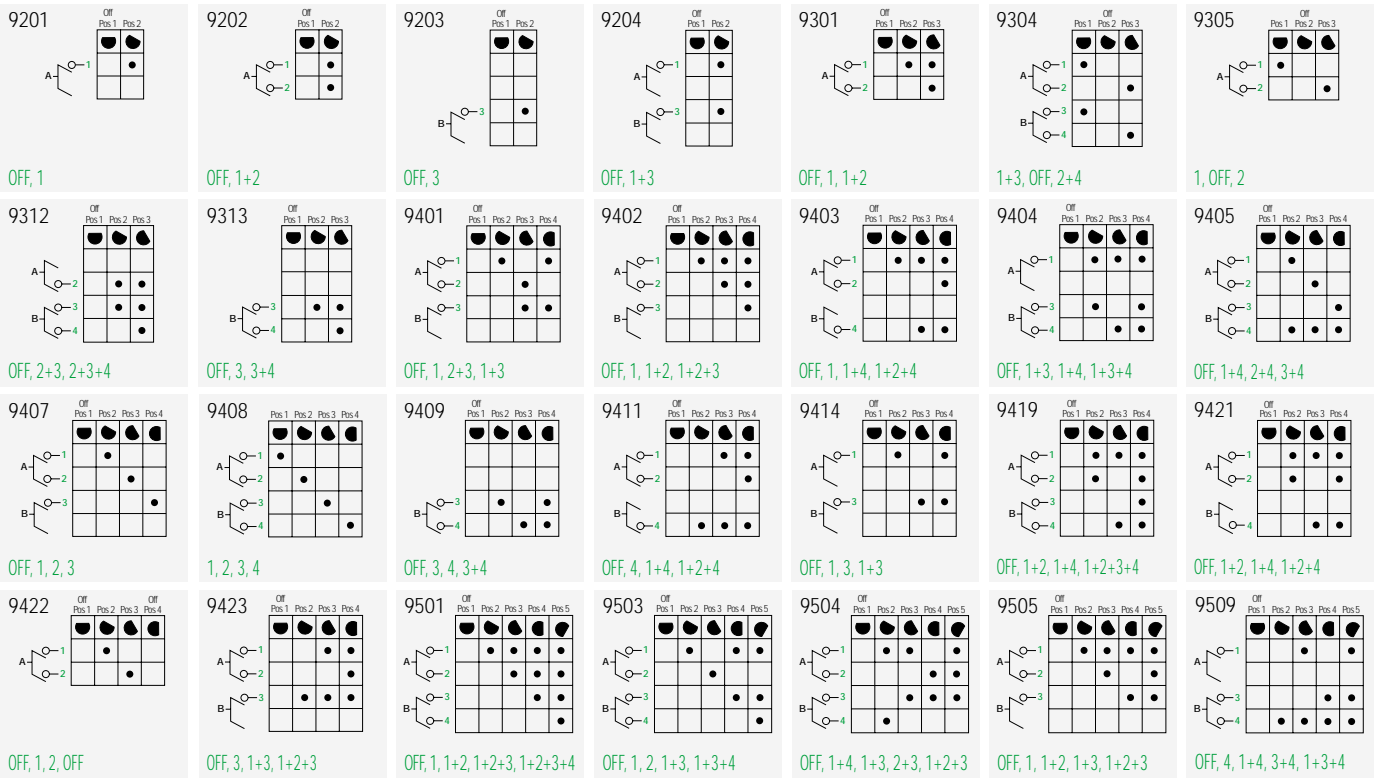

BODY

A
Standard 2 hole fixing

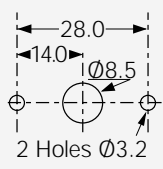

Recommended fixing
2 off No4 / 3.0mm self tapping screws
5.0mm min penetration into switch body

Snap together body sections withstand
>1.0Nm separation force

Stacked Switches
For more complex switching a second switch may be stacked on the first

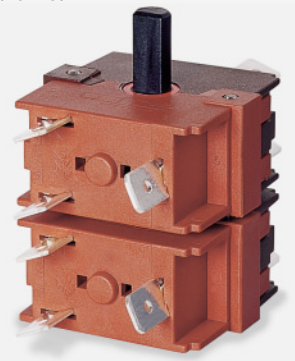

OPTIONS

Anti-rotation stops
May be fitted at any of the index positions to limit the maximum angle of rotation

Panel clearance
A spacer can be fitted to the switch body to increase the clearance between the mounting panel and switch terminals

For all options call the factory

DIMENSIONS (mm)

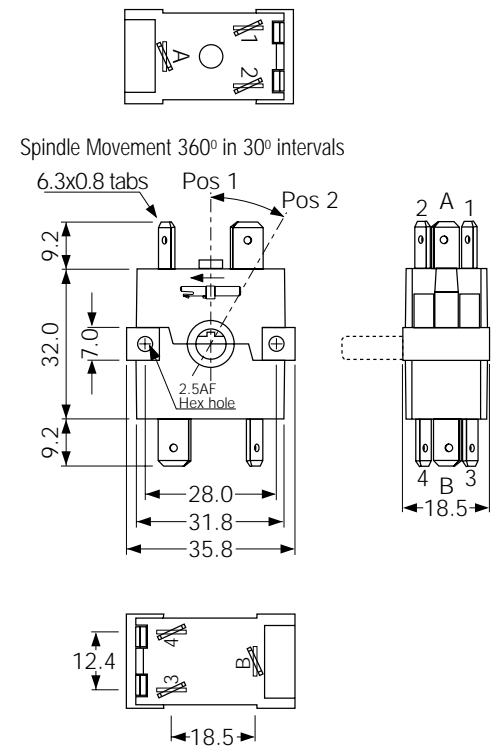

Note
In the circuits on this page, the symbol ● shows the position of the switch cam, NOT the position of the spindle flat

9000 Rotary Switches *For Foot Spas 2A 250Vac*



2A 250Vac T85



UL 2A 250Vac, 65°C, file E45221

μ contact gap

Technical data on pages 4 & 5

A 4-position single pole rotary switch.

All nylon construction, threaded neck and flatted 6.0mm dia. spindle.

Positive detent action, 90° between index positions.

Stops available to restrict rotation.

Various circuits may be obtained by changing the supply and load connections or by omission of one or two terminals.

Line and loads may be connected to any terminals.

Any three of the four contacts are always connected.

Illustrated loads and line are for example only.

Suitable for class II appliances.

Patent app.



T9000 00 ---

T 9000

TERMINAL FUNCTION

TERMINAL	FUNCTION	BODY	OPTIONS
<p>T</p> <p>Solder</p>	<p>9000</p> <p>Position 1 <i>Viewed from terminal side</i></p> <p>Position 2</p> <p>Position 3</p> <p>Position 4</p>	<p>Panel Cut-out</p> <p>Panel thickness 1.25 - 3.5mm</p>	<p>Rotation Stops</p> <p>Can be specified to limit the number of switching positions</p>

Dimensions (mm)

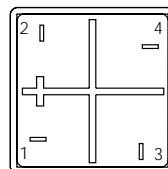
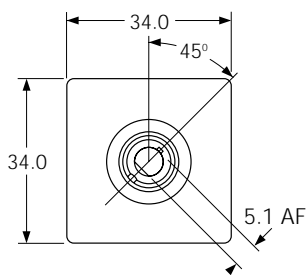
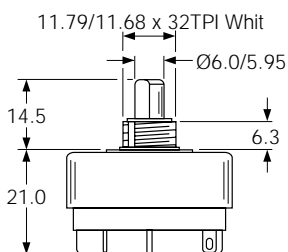

0600 Lever Switches 1A 250Vac

In house test 1A 250Vac
10A 6/24Vdc

3mm contact gap
Technical data on pages 4 & 5



C0600HD - - -

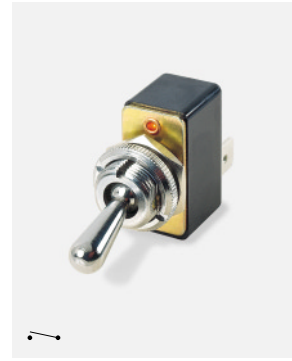

C0600CC - - -

C 0600 H D - - -

TERMINAL FUNCTION ACTUATOR BODY OPTIONS

▶ TERMINAL	▶ FUNCTION	▶ ACTUATOR	▶ BODY	▶ OPTIONS
<p>C</p> 	<p>0600</p> <p>ON - OFF</p> <p>0602</p> <p>ON - OFF (momentary ON)</p>	<p>C Chromed brass (0600)</p> <p>U Nylon (0600)</p> <p>G Nylon (0600)</p> <p>H Nylon (0600)</p> <p>S Chromed brass stem/ nylon paddle (0602 only)</p>	<p>D Nylon neck and top plate (Used with actuator codes U, G and H)</p> <p>C Metal neck and top plate (Used with actuator codes C and S)</p> <p>Panel thickness - 3.5mm Back nut must be fitted</p> <p>Fixing nuts (Standard is M506 & T92)</p> <p>T5 Hex brass M506 Hex nylon</p> <p>T92 Knurled brass</p> <p>M279 Knurled nylon</p>	<p>Cover M331 (C Actuator only)</p> <p>Seal M539 (C,H & U Actuators) Actuator visible</p> <p>Cover M1080 (C Actuator only)</p> <p>Covers have internal nylon nuts</p>

Dimensions (mm)

0600 (U actuator shown)

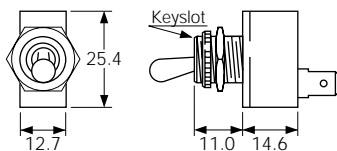

0602

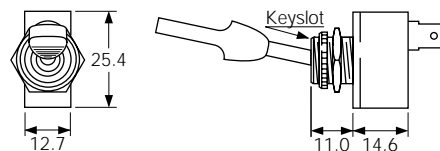

3900 Splashproof Metal Lever Switches 16A 250Vac



16(4)A 250Vac T85 (3900 & 3950)
 10(4)A 250Vac T85 (All other circuits)
 UL CSA 20A 125/277Vac (ON-OFF Circuits)
 UL CSA 16A 125/277Vac (Other Circuits)
 UL CSA 7A 72Vdc, 14A 36Vdc
 UL 250Vac 1hp, 125Vac 1/2hp
 UL 85°C, file E45221, CSA file LR10990

Inrush rating - Contact factory for details

Approvals and ratings vary with function
 3mm contact gap except where marked μ
 Integral O-ring neck seal
 Technical data on pages 4 & 5

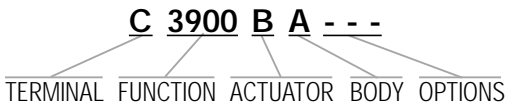

▶ TERMINAL	▶ FUNCTION		▶ ACTUATOR	
C 6.3 x 0.8	Single pole 	Double pole 	B 17.5	
	3900 	ON - OFF 		3950
	3901 	ON - OFF (momentary ON) 		3951
	3902 	ON - OFF (momentary OFF) 		3952
	3910 	ON - ON 		3960
	3911 	ON - ON (momentary 1 side) 		3961
	3920 	ON - OFF - ON μ 		3970
	3921 	ON - OFF - ON μ (momentary 1 side) 		3971
	3922 	ON - OFF - ON μ (momentary 2 sides) 		3972
	S 10.5 Screw & clamp available for On - Off switches only			Finish is nickel plate
T Ø3.1 10.5 Solder				



C3900BA ---



C3920BA ---

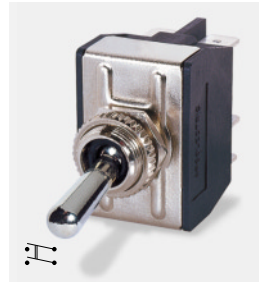

C3950BB ---



C3972BB ---



Guard R17-10
Anti-rotation tab can be specified for guard fitted in On or Off position

BODY

A
Without terminal barrier
Single pole

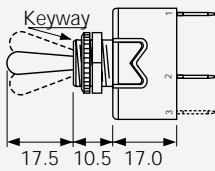

B
With terminal barrier
Double pole only

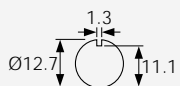
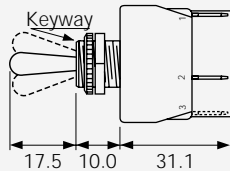

Panel hole (all types)

OPTIONS

Neck Seal M539

Actuator is visible



Cover M1080



Covers have internal nylon nuts

Fixing nuts

Nickel plated brass are supplied



Hex Back nut

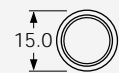

Knurled Front nut

Panel thickness 4.0 with backnut

DIMENSIONS (mm) * Indicates ON position (for On - Off switches)

Single Pole

(C terminals shown)

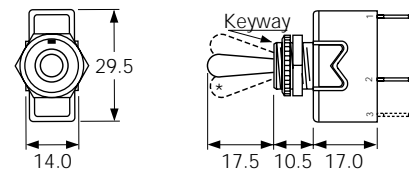

Optional P232 plate SP or DP

Double Pole

(C terminals shown)

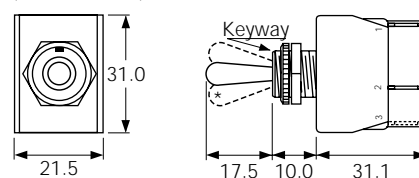

1700 & 1750 Lever Switches 16A 250Vac Single and Double Pole



16(4)A 250Vac T85



UL 20A 250Vac Non Ind (Single pole)
 UL 16A 250Vac Non Ind (Double pole)
 UL CSA (2 pos types) 250Vac 1hp, 125Vac 1/2hp
 UL CSA (3 pos types) 250Vac 1/2hp, 125Vac 1/4hp
 CSA 16A 250Vac Non Ind
 UL 85°C, file E45221, CSA file LR10990
 UL and CSA N/A on momentary types

In house test Inrush 36A to EN61058-1 & 20A 28Vdc

Selective "A, B, C" and "Off, A, A+B" circuits at 5 amp also available
 3mm contact gap except where marked μ
 Technical data on pages 4 & 5

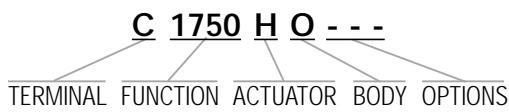

TERMINAL	FUNCTION	ACTUATOR
C 6.3 x 0.8	Single pole 1700 \blacklozenge ON - OFF	Double pole 1750
H 4.8 x 0.8	1710 μ \blacklozenge ON - ON	1760 μ
K 2.8 x 0.8	1720 μ \blacklozenge ON - OFF - ON	1770 μ
T Solder	1721 μ ON - OFF - ON (momentary 1 side)	R 13.8
X PCB 0.8 Sq	1722 μ ON - OFF - ON (momentary 2 sides)	

The switch is on between centre terminals (2 & 5) and the terminals over which the lever is positioned



C1700RO ---



C1700HO ---



C1760RO ---



C1750HO ---

BODY

0
Single pole

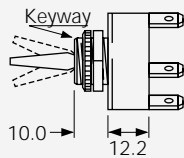

0
Double pole

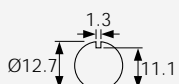
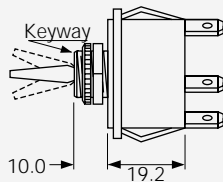

Panel hole (all types)

Panel thickness (Max)
Both nuts - 3.5mm
Less backnut - 6.5mm

OPTIONS

Neck Seal M539
Rubber -57T145
(H & R Actuators)
Actuator visible



Cover M1080
Rubber -57T145
(R Actuator only)



Cover M331
PVC -5T85
(R Actuator only)



Covers have internal nylon nuts

Fixing nuts (Standard is M506 & T92)

T5 Hex brass
M506 Hex nylon

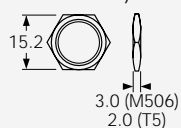

T92 Knurled brass

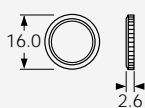

M279 Knurled nylon

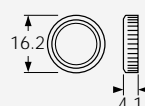

DIMENSIONS (mm)

Single Pole

(C terminals shown)

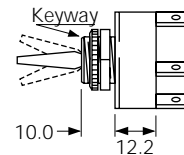
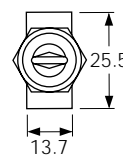

Optional
P232 plate
SP or DP

Double Pole

(C terminals shown)

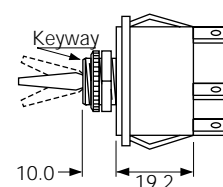
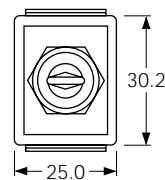

Optional terminal barrier M441 is available

Technical Information - Indicators

The majority of Arcoelectric indicator lights can be supplied with alternative light sources:

Neon, Fluorescent, Filament lamp or LED.

NEON and FLUORESCENT LAMPS

Colours

Red, Amber and Clear neon, Green fluorescent.

Maximum striking voltages

Standard brightness types 65Vac 90Vdc,

High brightness types 85Vac 135Vdc.

High brightness types are usually fitted.

Life

Typically 25,000 hours (Green fluorescent lamps 20,000 hours).

(Measured to a point when the light output of the lamp is half its original level.)

The end of life for a neon lamp is not usually a sudden failure.

False signals due to long wiring

It is possible for neon or fluorescent tubes to glow when they should be off. The false signal is caused by the capacitance effect of fairly long wiring to the indicator being adjacent to other live cables.

This effect can be prevented in most cases by fitting a 100K resistor across the supply wires close to the indicator assembly.

MATERIALS

Moulded bodies and bases	Nylon 6.6
Metal bodies and bezels	Chrome plated brass (except #)
Lenses	Polycarbonate
Terminals (most types)	Brass (electro-tin plated)
Terminals (exceptions)	Brass (flash silver* or nickel** plated)
Threaded metal nuts	Brass (nickel plated on 0275/7)
Other fixings	Call factory for details

* R9, 0061, 0062, 0430, 0480, 1090, 1091, 6030, 7030, 8630, 8580

** # 3130, 3160, 3161, 3221 have nickel plated terminals with steel screws and plated polyamide bezel trims

TEMPERATURE RATING

Authority	with Terminals	with Wire leads	
		PVC	SILICONE
European	T125°C	T105°C	T125°C
UL	T65/75°C	T65/75°C	

SYMBOLS

 Terminals
C 6.3, H 4.8, K 2.8

 Wire leads
200mm long Standard

 Solid wires
LED only

 Panel hole size

 Panel thickness

 Temperature rating

FILAMENT LAMPS

Colours

Red, Amber, Green, (Clear and Blue - check availability)

LEDS

Colours

Red, Yellow and Green.

Voltage

Basic voltage 2.0/2.2V. Some items are available with integral resistors for 12V use. For details of resistors required for higher voltages, please call the factory.

Current

Maximum continuous forward current 35mA.

Life

>100,000hrs

Polarity

LED flat side is - negative, round side + positive.

Indicator Lights (Neon, LED and Filament Lamp)



UL file E63363

CSA file LR29381

Colours and voltages:

Neon	Red, Amber, Green, Clear 100/130V (marked 110V), 200/250V (marked 230V)
LED	Red, Yellow, Green 2.0/2.2V Resistors for other voltages available
Filament lamp	Red, Amber, Green, (Clear & Blue check availability) 6V, 12/14V, 24/28V

To create a catalogue number:

Refer to the 2 columns below (terminal and type)

Then state:

Lens colour, voltage and whether neon, LED or filament lamp

TERM	TYPE	PANEL & °C
C 6.3	(C) 0145 AA S D N F S UL	Ø 5.8 3.0max page 66
L W	(L) 1041 00 Chrome bezel UL	Ø 6.3 6.3max page 66
L W	(L) 1045 00 Chrome bezel available S D N F S UL	Ø 6.3 10.0max page 66
L W	(L) 0245 00 Chrome bezel available S D N F S UL	Ø 7.1 6.3max page 66
L	L 2950 00 Chrome bezel available S D N F S UL SF	Ø 8.0 0.8-1.6 page 66
L C 6.3	(L) 0195 BB S D N F KEMA EUR S UL	Ø 8.0 0.8-3.0 page 66

DIMENSIONS (mm)

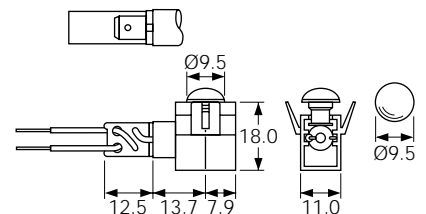
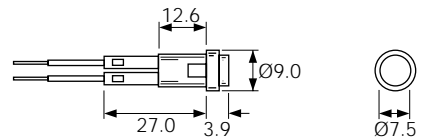
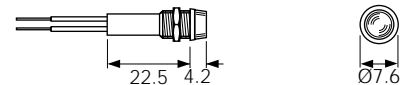
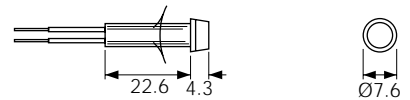
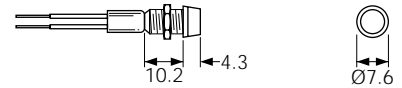
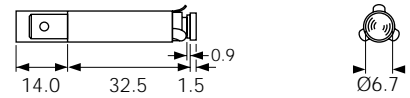

Indicator Lights (Neon, LED and Filament Lamp)



UL file E63363

CSA file LR29381

Colours and voltages:







Neon	Red, Amber, Green, Clear 100/130V (marked 110V), 200/250V (marked 230V)
LED	Red, Yellow, Green 2.0/2.2V Resistors for other voltages available
Filament lamp	Red, Amber, Green, (Clear & Blue check availability) 6V, 12/14V, 24/28V

To create a catalogue number:

Refer to the 2 columns below (terminal and type)





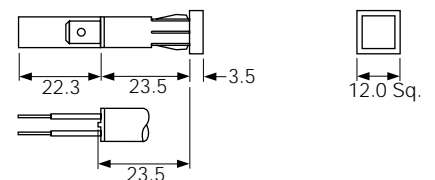
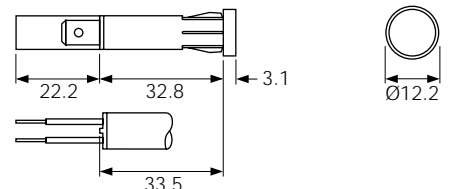
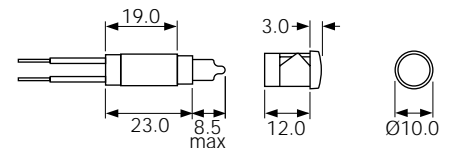
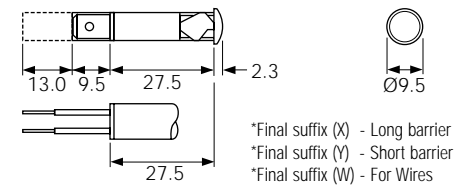
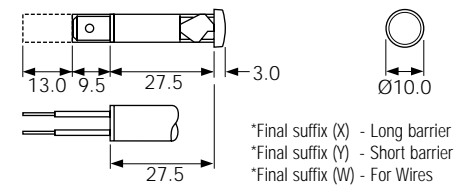
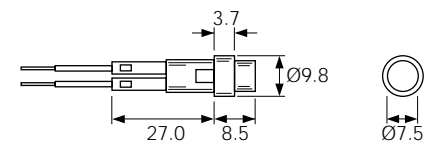

Then state:

Lens colour, voltage and whether neon, LED or filament lamp

TERM	TYPE	PANEL & °C
L	L 2951 00 Chrome bezel available  S D N FI KEMA UR	8.0 0.8-1.6 page 66
L K 2.8 H 4.8	(H) 0568 A(*) Deep lens profile  NEW UR (VDE at T100)	8.0 0.8-3.5 page 66
L K 2.8 H 4.8	(H) 0568 B(*) Shallow lens profile  NEW UR (VDE at T100)	8.0 0.8-3.5 page 66
L	(L) 0569 AW  NEW UR	9.0 0.8-2.5 Call factory
L K 2.8 H 4.8 C 6.3	(C) 0273 00  S D N FI KEMA UR	9.0 2.0 max page 66
L K 2.8 H 4.8 C 6.3	(C) 0278 00  S D N FI KEMA UR	9.0 2.0 max page 66

DIMENSIONS (mm)



TERM	TYPE	PANEL & °C
L K 2.8 H 4.8 C 6.3	(C) 0276 AA  S D N PH KEWA S RU SF	Ø 9.5 0.8-2.8 page 66
L K 2.8 H 4.8 C 6.3	(C) 0275 00  S D N PH KEWA S RU SF	Ø 10.0 12.0 max page 66
L K 2.8 H 4.8 C 6.3	(C) 0275 00 Chrome bezel  S D N PH KEWA S RU SF	Ø 10.0 11.5 max page 66
L K 2.8 H 4.8 C 6.3	(C) 0276 00  S D N PH KEWA S RU SF	Ø 10.0 2.8 max page 66
L K 2.8 H 4.8 C 6.3	(C) 0277 00 Chrome bezel  S D N PH KEWA S RU SF	Ø 10.0 12.0 max page 66
L K 2.8 H 4.8 C 6.3	(C) 0273 LL  S D N PH KEWA S RU SF	Ø 10.0 0.6-2.0 page 66

DIMENSIONS (mm)

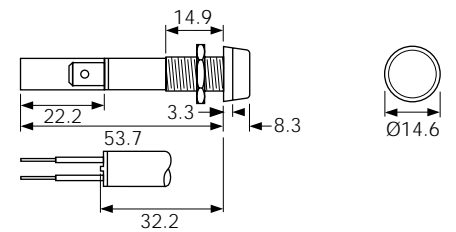
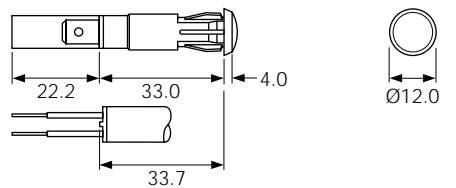
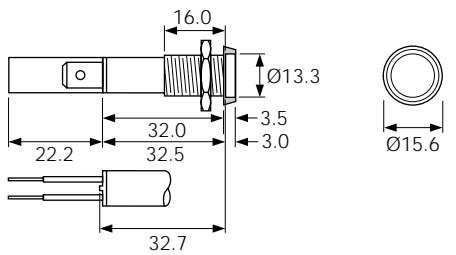
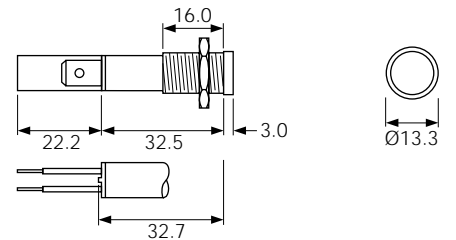
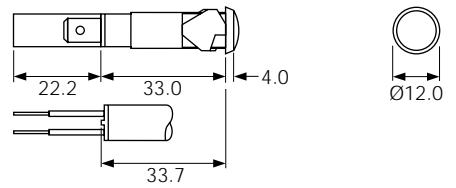

For sub-panel mounting, behind a fascia

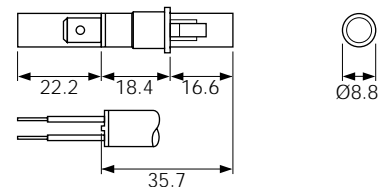

Indicator Lights (Neon, LED and Filament Lamp)



UL file E63363

CSA file LR29381

Colours and voltages:







Neon	Red, Amber, Green, Clear 100/130V (marked 110V), 200/250V (marked 230V)
LED	Red, Yellow, Green 2.0/2.2V Resistors for other voltages available
Filament lamp	Red, Amber, Green, (Clear & Blue check availability) 6V, 12/14V, 24/28V

To create a catalogue number:

Refer to the 2 columns below (terminal and type)



Then state:

Lens colour, voltage and whether neon, LED or filament lamp

TERM	TYPE	PANEL & °C
L K 2.8 H 4.8 C 6.3	(C) 2820 00  UL, S, D, N, FI, KEMA, UL, etc.	Ø 12.0 0.75-2.0 page 66
L K 2.8 H 4.8 C 6.3	(C) 2821 00  UL, S, D, N, FI, KEMA, UL, etc.	Ø 12.0 or 12.7 Ø12.0 = 0.8-2.5 Ø12.7 = 1.1-2.5 page 66
L K 2.8 H 4.8 C 6.3	(C) 0586 00  UL, S, D, N, FI, KEMA, UL, etc.	Ø 12.5 0.8-1.5 page 66
L K 2.8 H 4.8 C 6.3	(C) 2870 00  UL, S, D, N, FI, KEMA, UL, etc.	Ø 12.7 0.75-2.0 page 66
L K 2.8 H 4.8 C 6.3	(C) 0589 00  UL, S, D, N, FI, KEMA, UL, etc.	Ø 12.7 0.8-1.5 page 66
L	L 0081 00 Chrome bezel  UL	Ø 12.7 9.5 page 66

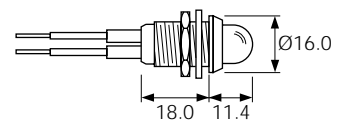
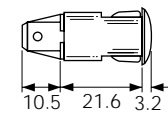
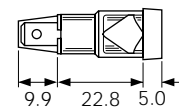
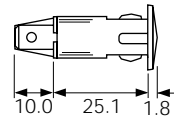
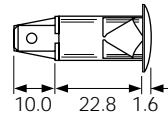
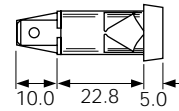
DIMENSIONS (mm)



TERM	TYPE	PANEL & °C
L K 2.8 H 4.8 C 6.3	(C) 0177 00 Chrome bezel  KEMA KEUR RU	Ø 12.7 12.0max page 66
L K 2.8 H 4.8 C 6.3	(C) 0067 00 Chrome bezel  RU	Ø 12.7 1.14max page 66
L K 2.8 H 4.8 C 6.3	(C) 0180AA  RU	Ø 12.7 19.0max page 66
L K 2.8 H 4.8 C 6.3	(C) 0180BB Chrome bezel  RU	Ø 13.5 0.9-1.14 page 66
L K 2.8 H 4.8 C 6.3	(C) 0579 00  KEMA KEUR RU	Ø 14.0 2.5max page 66

DIMENSIONS (mm)

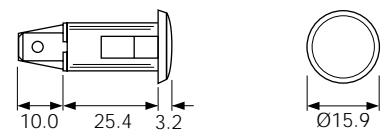
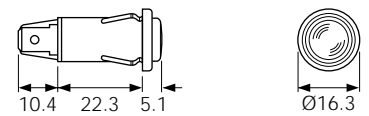
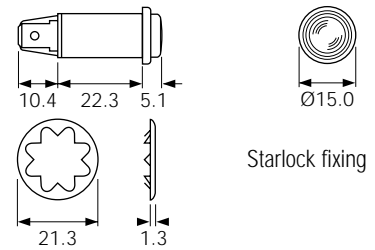
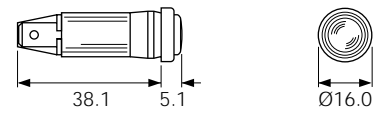
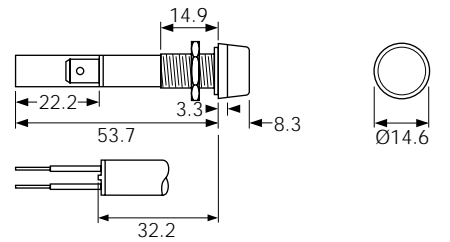

Indicator Lights (Neon, LED and Filament Lamp)



UL file E63363

CSA file LR29381

Colours and voltages:

Neon	Red, Amber, Green, Clear 100/130V (marked 110V), 200/250V (marked 230V)
LED	Red, Yellow, Green 2.0/2.2V Resistors for other voltages available
Filament lamp	Red, Amber, Green, (Clear & Blue check availability) 6V, 12/14V, 24/28V

To create a catalogue number:

Refer to the 2 columns below (terminal and type)

Then state:

Lens colour, voltage and whether neon, LED or filament lamp

* Call factory for details

TERM	TYPE	PANEL & °C
H 4.8	H 0581 AY NEW	 18.2/18.3 X 6.2/6.3* 2.0-3.5 page 66
C 6.3	C 0582 AY NEW	 32.5/32.6 X 10.0/10.1* 0.8-2.3 page 66
L	L 0195 00 	 13.0x6.5 0.8-3.0 page 66
L C 6.3	(C) 0196 AA 	 13.0x6.5 0.8-3.0 page 66
L	L 0234 00 	 9.27/9.50 X 4.75* 0.71-1.62 page 66
L	L 0233 00 	 page 66

DIMENSIONS (mm)

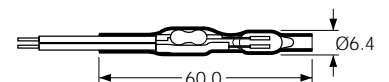
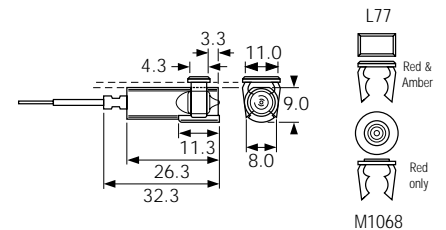
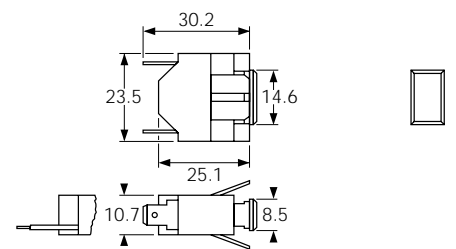
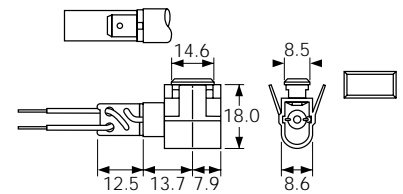
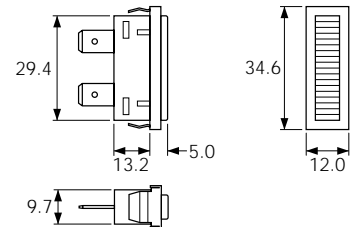
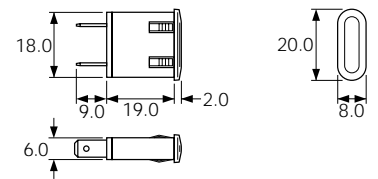

Neon tube, resistor and flexible lead assembly, protected by "shrunk on" transparent sleeving

Indicator Lights (To match 8500, 8600, R13, 1500, 1550, 5500, 6000, 8300 and 7000 switches)



UL file E63363

CSA file LR29381

Colours and voltages:

Neon	Red, Amber Green, Clear 100/130V (marked 110V), 200/250V (marked 230V)
LED	Red, Yellow, Green 2.0/2.2V Resistors for other voltages available
Filament lamp	Red, Amber, Green, Clear and Blue 6V, 12/14V, 24/28V

For full product details, to create a catalogue number or to order:

Refer to the catalogue page shown against each item

TERM	TYPE
H 4.8	H8580 AB Approvals: S, D, N, H, FI, KEMA, S, UL, SF
H 4.8	H8630 FB Approvals: S, D, N, H, FI, KEMA, S, UL, SF
T	
X	
H 4.8	R9 92B Factoryed product Approvals details - contact the factory
C 6.3	C0430 A(*) NEW C6030 AL Approvals: S, D, N, H, FI, KEMA, S, UL, SF <small>6030 - L body & C terminals only</small>
H 4.8	
K 2.8	
T	
U	
C 6.3	C0480 A(*) Approvals: S, D, N, H, FI, KEMA, S, UL, SF
H 4.8	
K 2.8	
T	
U	
C 6.3	C7030 AH Approvals: S, D, N, H, FI, KEMA, S, UL, SF
H 4.8	

DIMENSIONS (mm)

Full product details on pages 10-11			Cut-out	Flange
Body Code	Panel thickness	Cut-out X Y		
B	0.75-1.25 1.25-2.0 2.0-3.0	19.1/19.2 19.3/19.4 19.7/19.8	12.9/13.0 12.9/13.0 12.9/13.0	21.0 15.0
Full product details on pages 12-13			Cut-out	Flange
Body Code	Panel thickness	Cut-out X Y		
B	0.75-1.25 1.25-2.0 2.0-3.0	19.1/19.2 19.3/19.4 19.7/19.8	12.9/13.0 12.9/13.0 12.9/13.0	21.0 15.0
Full product details on pages 16-17			Cut-out	Flange
Snap fixing in panels thickness up to 3.0				
			Ø20.2	Ø23.0
Full product details on pages 18-19 & 20-21			Cut-out	Flange
Body *Code	Cut-out Y X	Flange Y X		
A	12.2/12.3 27.2/27.3	14.0 30.2	X	X
B	11.0/11.1 30.0/30.1	14.0 33.4	X	X
L	11.0/11.1 30.0/30.1	14.0 31.9	X	X
R	14.0/14.1 28.5/28.6	17.0 31.5	X	X
Full product details on pages 26-27			Cut-out	Flange
Body *Code	Cut-out Y X	Flange Y X		
A	22.3/22.4 27.2/27.3	25.0 30.2	X	X
B	22.1/22.2 30.0/30.1	25.0 33.4	X	X
L	22.1/22.2 30.0/30.1	25.0 32.0	X	X
R	23.0/25.4 28.4/28.5	28.9 33.2	X	X
Full product details on pages 38-39			Cut-out	Flange
Body Code	Cut-out	Flange		
H	Ø25.0/25.2	Ø28.0	25.0/25.2	Ø28.0

Neon & LED Indicator Lights Sealed to IP52 and IP54



Colours and voltages:

Neon	Red, Amber, Green 120/230Vac 0.5W (Red base)
LED	Red, Amber, Green 28Vac/dc 1W (Green base)

Neon versions feature integral current limiting & ghost lighting resistors
LED versions have rectifier diodes & resistors for direct connection to 28Vac/dc

To order

Select a number from the "type" column

Then state:

Lens colour, voltage and whether neon or LED

All versions have recessed screw terminals

IP52 is standard. A panel sealing washer is available for IP54

TERM	TYPE	PANEL & °C
 Recessed Screw	3130 No bezel 	 13.2 8.0max T120 neon T50 LED
 Recessed Screw	3160 Black bezel 	 16.2 5.0max T120 neon T50 LED
 Recessed Screw	3161 Satin chrome style bezel 	 16.2 5.0max T55 neon T50 LED
 Recessed Screw	3221 Large black bezel 	 22.3 4.5max T120 neon T50 LED

DIMENSIONS (mm)

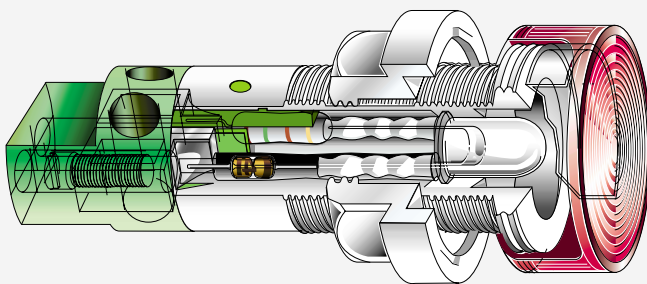
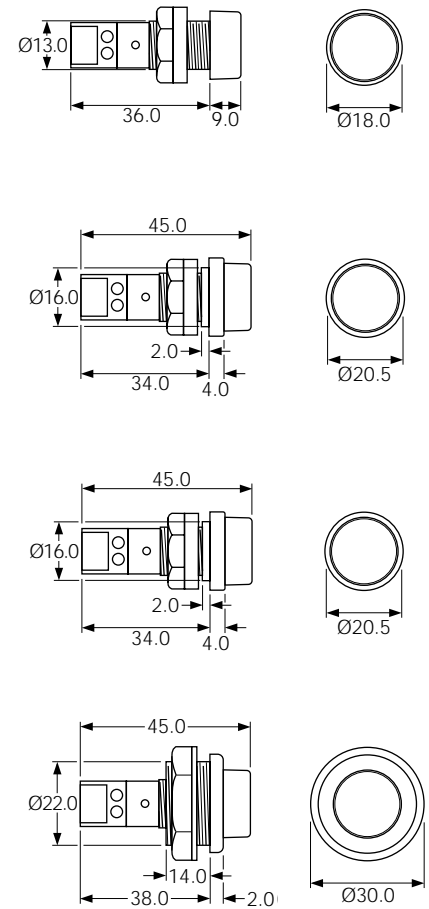

Select the version most suitable for your application from the 4 types shown

Or call the factory for availability to your special requirements

Low Voltage Lampholders

Colour and voltage:

These lampholders are suitable for up to 50V max.
Bulbs will be supplied (dependent on order quantity)
if a voltage is specified

Colours - Red, Amber, Green, (Clear & Blue, check availability)

To create a catalogue number:

Refer to the 2 columns below (terminal and type)

Then state:

Lens colour and voltage

TERM	TYPE	PANEL & °C
T 	T0061 AO (LES) 	 9.5  0.9-1.14  T85
C 6.3 	C0067 00 (BA7s) Chrome bezel 	 12.7  1.14max  T85
T 	T0062 AO (Midget flange) Chrome bezel  T0063 AO (LES) Chrome bezel	 12.7  9.6max  T85
T 	T0062 MO (Midget flange)  T0063 MO (LES)	 12.7  9.6max  T85
S 	S0095 00 	 T85

DIMENSIONS (mm)

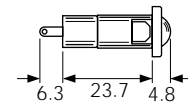

Rear of panel bulb replacement

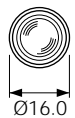
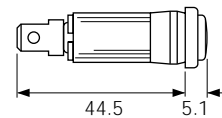

Rear of panel bulb replacement

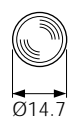
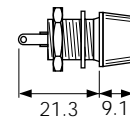

Front of panel bulb replacement

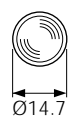
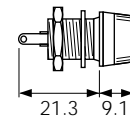

Front of panel bulb replacement

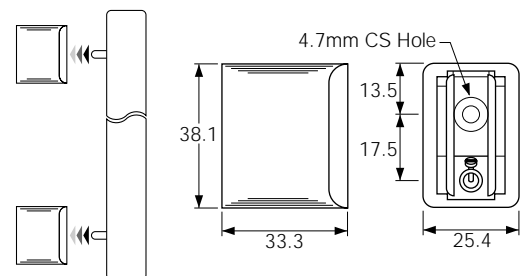

Paired Architectural lampholders with phillinea lamp

LED Lamps and LED Lampholders

LED Lampholders can be supplied with or without lamps

Colours:

Red, Yellow and Green LEDs
(High Intensity is standard. Option of extra super bright)

Voltages:















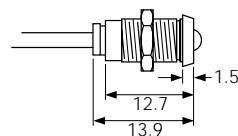





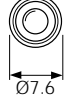







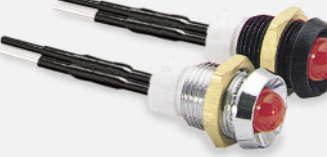

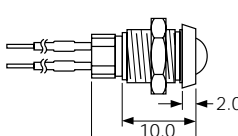
LEDs are available for direct connection to 2.0/2.2V. or 12Vdc
For other voltages contact the factory

To create a catalogue number:

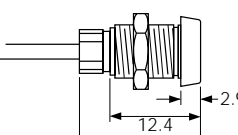
Refer to the 2 columns below (terminal and type)

Then state:

LED colour and voltage and body finish (Black or Chrome)

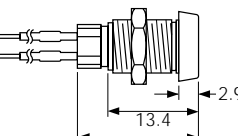
TERM	TYPE	PANEL & °C	DIMENSIONS (mm)	
W  LED fitted	(W) 1047 00  3mm LED	 6.3  6.3max  T85	 1.5 12.7 13.9	 Ø7.6
A LED not fitted				
L  LED & Wires fitted	L 1047 00  3mm LED	 6.3  6.3max  T85	 1.5 12.7 13.9	 Ø7.6
LED & Wires fitted				
W  LED fitted	(W) 1048 00  5mm LED	 8.0  5.5max  T85	 2.0 10.0 14.5	 Ø9.5
A LED not fitted				
L  LED & Wires fitted	L 1048 00  5mm LED	 8.0  5.5max  T85	 2.0 10.0 14.5	 Ø9.5
LED & Wires fitted				
W  LED fitted	(W) 1050 00  5mm LED with focusing reflector	 8.0  7.0max  T85	 2.9 12.4 16.9	 Ø10.0
A LED not fitted				
L  LED & Wires fitted	L 1050 00  5mm LED with focusing reflector	 8.0  7.0max  T85	 2.9 13.4 17.9	 Ø10.0
LED & Wires fitted				

LED Lamps and LED Lampholders - Designed to IP66

LED Lampholders can be supplied with or without lamps

Colours:

Red, Yellow and Green LEDs
(High Intensity is standard. Option of extra super bright)

Voltages:





















LEDs are available for direct connection to 2.0/2.2V. or 12Vdc
For other voltages contact the factory

To create a catalogue number:

Refer to the 2 columns below (terminal and type)

Then state:

LED colour and voltage and body finish (Black or Chrome)

TERM	TYPE	PANEL & °C
W  LED fitted	(W) 1048 OA Designed to IP66  5mm LED	 8.0  5.5max  T85
A LED not fitted		
L  LED & Wires fitted	L 1048 OA Designed to IP66  5mm LED	 8.0  5.5max  T85
W  LED fitted	(W) 1050 OA Designed to IP66  5mm LED with focusing reflector	 8.0  7.0max  T85
A LED not fitted		
L  LED & Wires fitted	L 1050 OA Designed to IP66  5mm LED with focusing reflector	 8.0  7.0max  T85

DIMENSIONS (mm)

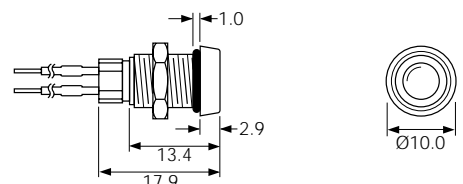
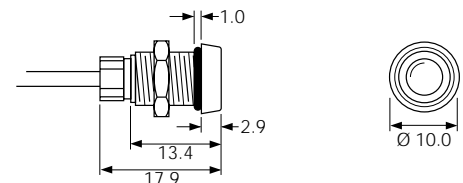
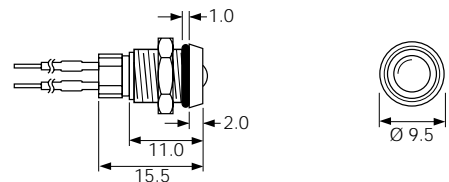
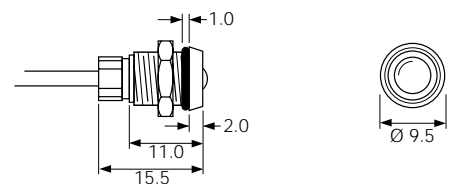

Properties

Sealing

O-ring sealing equivalent to IP66, of both the LED to bezel, and bezel to panel is available where shown

LED wires or PVC covered wire leads

125mm min length wires, 6.3mm standard strip
Alternative colours, length and strip available

Polarity

The nylon base mouldings are polarity marked

Body Material and Finish

Chromed brass or Black oxide coated brass

Lampholders only

Items prefixed 'A' are supplied without LEDs

Low Voltage Lampholders *with sealing option*

Bulbs will be supplied (dependant on order quantity) if a voltage is specified
 These lampholders are suitable for up to 50V max.

Colours - Red, Amber, Green, (Clear & Blue, check availability)
 Brass bodies have polished chrome finish









C1090FP - - -

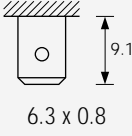

C1090FL - - -



TERMINAL	LAMP CAP	LENS	THREADED BODY																								
C  6.3 x 0.8	1090 E10 	F Flat 	<table border="1"> <thead> <tr> <th>Panel Hole Dia.</th> <th>Body Material</th> <th>Dimension A</th> </tr> </thead> <tbody> <tr> <td>A 19.0</td> <td>Brass</td> <td>35.0</td> </tr> <tr> <td>D 19.0</td> <td>Brass</td> <td>30.2</td> </tr> <tr> <td>E 19.0</td> <td>Nylon</td> <td>30.2</td> </tr> <tr> <td>*P 19.0</td> <td>Nylon (+ chrome trim)</td> <td>30.2</td> </tr> <tr> <td>G 19.0</td> <td>Brass</td> <td>24.6</td> </tr> <tr> <td>H 19.0</td> <td>Nylon</td> <td>24.6</td> </tr> <tr> <td>L 25.4</td> <td>Brass</td> <td>30.2</td> </tr> </tbody> </table>	Panel Hole Dia.	Body Material	Dimension A	A 19.0	Brass	35.0	D 19.0	Brass	30.2	E 19.0	Nylon	30.2	*P 19.0	Nylon (+ chrome trim)	30.2	G 19.0	Brass	24.6	H 19.0	Nylon	24.6	L 25.4	Brass	30.2
	Panel Hole Dia.	Body Material	Dimension A																								
A 19.0	Brass	35.0																									
D 19.0	Brass	30.2																									
E 19.0	Nylon	30.2																									
*P 19.0	Nylon (+ chrome trim)	30.2																									
G 19.0	Brass	24.6																									
H 19.0	Nylon	24.6																									
L 25.4	Brass	30.2																									
	1091 BA9s 	V Domed  N/A for L & M body L No lens 	<table border="1"> <thead> <tr> <th>Panel Hole Dia.</th> <th>Body Material</th> <th>Dimension A</th> </tr> </thead> <tbody> <tr> <td>B 19.0</td> <td>Brass</td> <td>35.0</td> </tr> <tr> <td>C 19.0</td> <td>Nylon</td> <td>35.0</td> </tr> <tr> <td>*Q 19.0</td> <td>Nylon (+ chrome trim)</td> <td>35.0</td> </tr> <tr> <td>M 25.4</td> <td>Brass</td> <td>41.8</td> </tr> </tbody> </table> <p>All E10 and BA9s types are suitable for panel thickness up to 6.2mm. Some versions will accept panels up to 11.2mm thick</p>	Panel Hole Dia.	Body Material	Dimension A	B 19.0	Brass	35.0	C 19.0	Nylon	35.0	*Q 19.0	Nylon (+ chrome trim)	35.0	M 25.4	Brass	41.8									
Panel Hole Dia.	Body Material	Dimension A																									
B 19.0	Brass	35.0																									
C 19.0	Nylon	35.0																									
*Q 19.0	Nylon (+ chrome trim)	35.0																									
M 25.4	Brass	41.8																									

DIMENSIONS mm

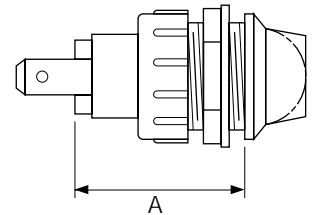

OPTIONS

Sealing

Neoprene washers to seal between bezel and panel (W23) and lens and bezel (W24) to give a seal equivalent to IP66 are available on most versions

F0445 MO

P.V.C. Insulating terminal cover.



*Note P and Q body codes denote a nylon body fitted with a chrome bezel trim (previously **F0413PO**)

IEC Connectors & NEMA Receptacles



10A 250Vac

UL CSA 10A 250Vac UL 65°C

Terminal data shown at section end

For stock availability & additional options call the factory

To order:

State type number, connector terminal code, switch terminal code (if applicable), and for snap-in items, the panel thickness. Stocked items are for 1.0mm panels

0711-1S LS K 1.0mm

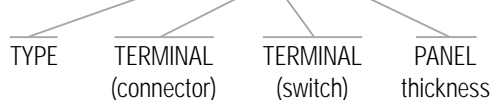

TYPE	TERMINAL
0707-1-C (2k min order) Inlet	S 2.5 Solder N 4.0 Solder Q 4.8 Tab W 6.3 Tab
0708-1-C Outlet	N 4.0 Solder Q 4.8 Tab W 6.3 Tab P PCB
0709-P Outlet	L 4.0 Solder Q 4.8 Tab
0710-P Outlet	V12 Solid Wire V16 Solid Wire
0711-1S Inlet with Voltage Select	LS 2.8 Solder Connector Q 4.8 Tab/Solder Connector T 3.0 Solder Switch K 2.8 Solder Switch
0711-P (2k min order) Inlet	S 2.5 Solder N 4.0 Solder Q 4.8 Tab W 6.3 Tab

DIMENSIONS (mm)

View below is at Y

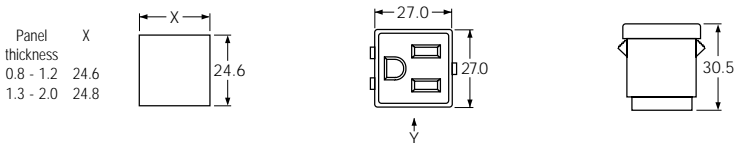
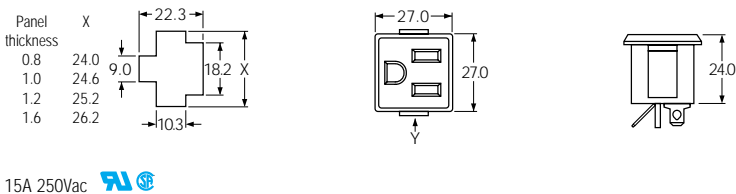
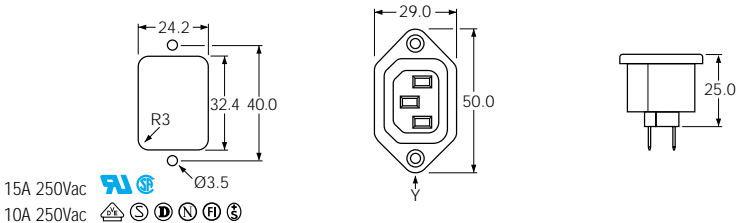
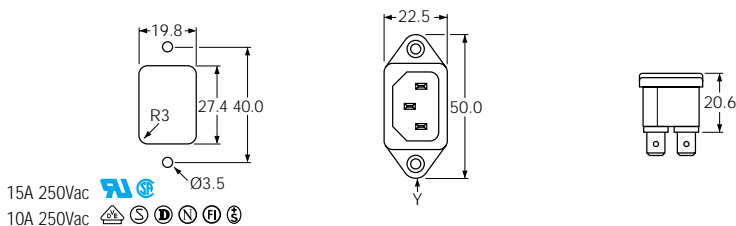

0710-PV16 is 13A 250Vac. 0710-PV12 is 15A 250Vac

SP 2 position switch is standard

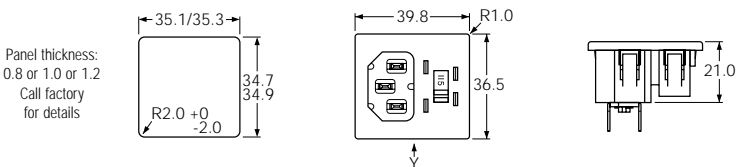

Rating/approval details on request

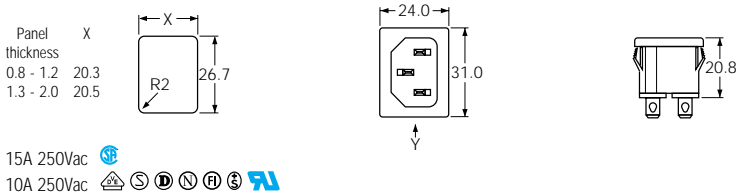

IEC Connectors & NEMA Receptacles



10A 250Vac

UL CSA 10A 250Vac UL 65°C

Terminal data shown at section end

For stock availability & additional options call the factory

To order:







State type number, connector terminal code, switch terminal code (if applicable), and for snap-in items, the panel thickness. Stocked items are for 1.0mm panels

0717-1S Q T 1.0mm

TYPE TERMINAL (connector) TERMINAL (switch) PANEL thickness

DIMENSIONS (mm)

View below is at Y

TYPE	TERMINAL
<p>0717-1-P</p>  <p>Fused Inlet 5x20</p>	<p>S 2.5 Solder</p> <p>LS 2.8 Solder</p> <p>Q 4.8 Tab</p> <p>W 6.3 Tab</p>
<p>0717-1S State "Non Lit"</p>  <p>Switched Fused Inlet 5x20</p>	<p>Q 4.8 Solder Connector</p> <p>T 4.8 Solder Switch</p>
<p>0717-1S State "Lit"</p>  <p>Switched Fused Inlet 5x20</p>	<p>Q 4.8 Solder Connector</p> <p>T 4.8 Solder Switch</p>
<p>0717-C</p>  <p>Fused Inlet 5x20</p>	<p>S 2.5 Solder</p> <p>LS 2.8 Solder</p> <p>Q 4.8 Tab</p> <p>W 6.3 Tab</p>
<p>0717-2-C (2k min order)</p>  <p>Double Fused Inlet 5x20</p>	<p>S 2.5 Solder</p> <p>LS 2.8 Solder</p> <p>Q 4.8 Tab</p> <p>W 6.3 Tab</p>
<p>0717-2-P (2k min order)</p>  <p>Double Fused Inlet 5x20</p>	<p>S 2.5 Solder</p> <p>LS 2.8 Solder</p> <p>Q 4.8 Tab</p> <p>W 6.3 Tab</p>

Panel thickness
0.8 - 1.2 31.4
1.3 - 2.0 31.6

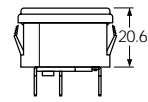
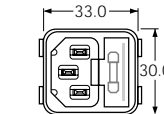
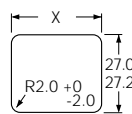

10A 250Vac

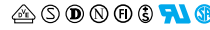

DP non-illuminated switch is standard

Panel thickness:
0.8 or 1.0 or 1.2
Call factory
for details

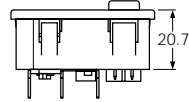
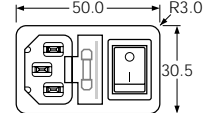
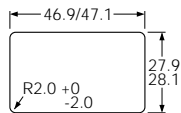

10A 250Vac



DP illuminated switch is standard

Panel thickness:
0.8 or 1.0 or 1.2
Call factory
for details

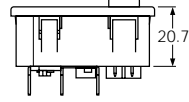
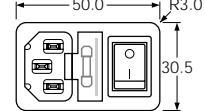
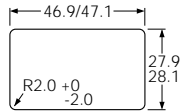

10A 250Vac



10A 250Vac

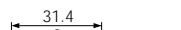

10A 250Vac

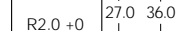

10A 250Vac

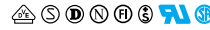

0717-2-C For applications (eg medical equipment) where both live & neutral feeds must be fused

10A 250Vac

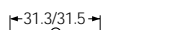

10A 250Vac

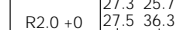

10A 250Vac

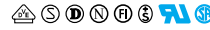









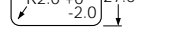

0717-2-P For applications (eg medical equipment) where both live & neutral feeds must be fused

10A 250Vac



10A 250Vac



TYPE	TERMINAL
0721-P (2k min order)  Inlet 	S Solder 
0722-C (2k min order)  Inlet 	Q 4.8 Solder  W 6.3 Tab 
0723-C (2k min order)  Outlet 	Q 4.8 Solder  W 6.3 Tab 

DIMENSIONS (mm)

View below is at Y

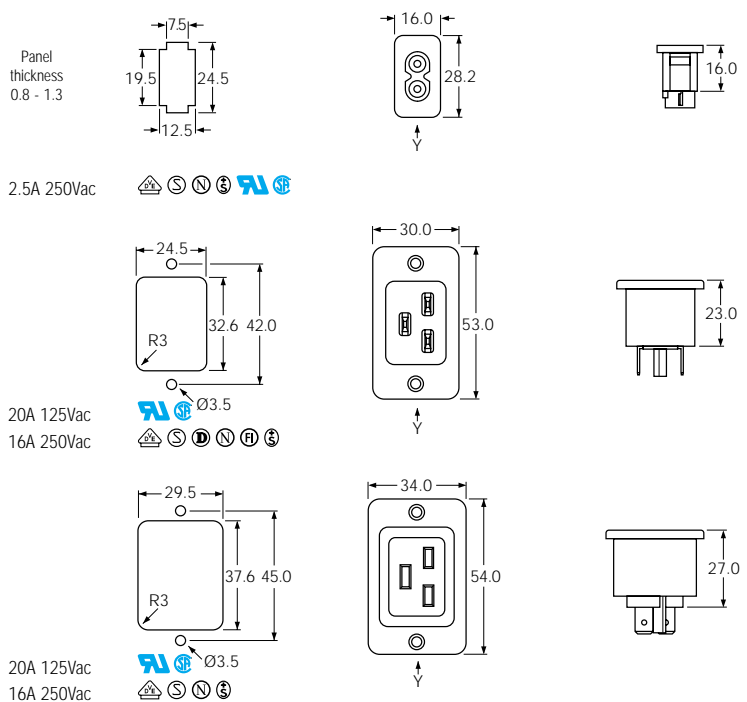













Technical data

Mouldings V2 (VO option)
 Connectors Tin plated solid brass
 Terminals Silver plated

Terminal dimensions

For Connectors

For Switches

For Connectors									Slide	Slide	Rocker
S	N	Q	W	P	L	LS	V12	V16	T	K	T
2.5mm Solder	4mm Solder	4.8mm Solder/ Fast on	6.3 Fast on	PCB	Solder	2.8mm Solder	12-14 AWG Solid Wire	16 AWG Solid Wire	Solder	2.8mm Solder	4.8mm Solder
											
1.5x2.5 4.5	2.0x3.2 5.5	2.8x3.3 6.5	Ø1.7 8.0	1.7x3.0 5.5	Ø3.0x6.0	1.5x3.0 10.0	1.35	0.8	2.5 6.0 1.6	2.5 7.0 1.3	R1.0 R0.8 3.5 8.5

Note: Designated solder terminals should not be fitted with "Push on", "OD" or "Fast on" type cable connectors

Fuseholders 5 x 20 mm



6.3A 250Vac (max fuse rating*) T-55 to T+70 (ambient)

Maximum dissipation wattage: 1.5W

UL 94V2 UL file E92075 CSA file LR44770

These products comply with safety category PC2

*Users should be aware of the de-rating factors published by specialist manufacturers of fuses

These fuseholders are fitted with combination (solder / 2.8) mid-body terminals
It has not been possible to show both views here



M520
Terminal Cover



A0033 00
In-line 5 x 20 fuseholder
Call factory for rating details

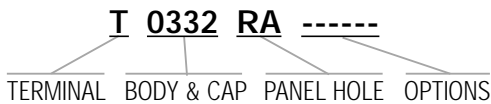

TERMINAL	BODY AND CAP	PANEL HOLE
<p>T</p> <p>Solder</p>	<p>0332 Finger release</p> <p>0333 Tool release</p> <p>0340 Tool release</p> <p>0341 Tool release</p>	<p>RA</p> <p>RD</p>

DIMENSIONS (mm)

0332 (T terminal shown)

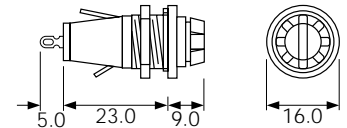

Panel thickness 0.8-4.5mm

0333 (T terminal shown)

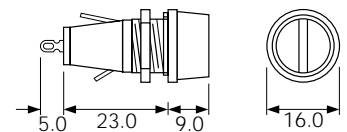

Panel thickness 0.8-4.5mm

0340 (T terminal shown)

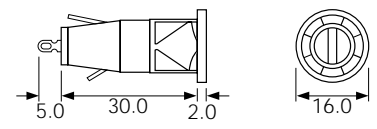

Panel thickness 0.8-2.0mm

0341 (T terminal shown)

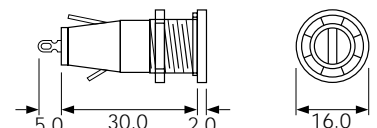

Panel thickness 0.8-4.5mm

Fuseholders 6 x 30 mm (1¼"x¼")



16A 250Vac (max fuse rating*) T-55 to T+70 (ambient)
 Maximum dissipation wattage: 2.5W
 UL 94V2 UL file E92075 CSA file LR44770

These products comply with safety category PC2

*Users should be aware of the de-rating factors published by specialist manufacturers of fuses

Fuseholders with in-line termination have combination (4.8 / 6.3) terminals. It has not been possible to show both views here. Units with right angle terminals have user specified end terminals and combination mid-body terminals



M873
Cover for C & T terminals



A0035 00
In-line 6 x 30 1¼ x ¼ fuseholder
Call factory for rating details

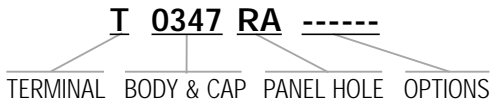

TERMINAL	BODY AND CAP	PANEL HOLE	DIMENSIONS (mm)
<p>C</p> <p>6.3 x 0.8</p>	<p>0345 (C terminal shown)</p> <p>Ⓢ Ⓝ Ⓟ Ⓡ Ⓢ Ⓡ</p>	<p>RA</p> <p>Panel thickness 0.8 - 2.0mm for snap-in 0.8 - 4.5mm for nut fixing</p>	<p>0345 (C terminal shown)</p>
<p>D</p> <p>6.3 x 0.8 Right angle</p>	<p>0345 (D terminal shown)</p> <p>Ⓢ Ⓝ Ⓟ Ⓡ Ⓢ Ⓡ</p>	<p>RD</p> <p>Panel thickness 0.8 - 2.0mm for snap-in 0.8 - 4.5mm for nut fixing</p>	<p>0345 (D terminal shown)</p>
<p>T</p> <p>4.8 x 0.8 Solder</p>	<p>0347 (T terminal shown)</p> <p>Ⓢ Ⓝ Ⓟ Ⓡ Ⓢ Ⓡ</p>	<p>RD</p> <p>Panel thickness 0.8 - 2.0mm for snap-in 0.8 - 4.5mm for nut fixing</p>	<p>0347 (C terminal shown)</p>
<p>U</p> <p>4.8 x 0.8 Right angle solder</p>	<p>0347 (U terminal shown)</p> <p>Ⓢ Ⓝ Ⓟ Ⓡ Ⓢ Ⓡ</p>	<p>RD</p> <p>Panel thickness 0.8 - 2.0mm for snap-in 0.8 - 4.5mm for nut fixing</p>	<p>0347 (D terminal shown)</p>

Index

Cat No.	PAGE	Cat No.	PAGE	Cat No.	PAGE
0005	61,65	0919	41	5503	22
0023	78	0920	41	5508	22
0024	78	0936	47	6000	18
0033	82	0938	47	6000 Twin units	25
0035	83	992B	17,73	6001	18
0042	23,25,27,29	1041	67	6002	18
0046	19,21,23	1045	67	6003	18
0055	54	1047	76	6008	18
0056	54	1048	76,77	6009	18
0061	75	1050	76,77	6010	18
0062	75	1067	25	6011	18
0063	75	1080	61,63,65	6030	18,73
0067 Lampholder	75	1090	78	6050	24
0067 Neon	71	1091	78	6051	24
0081	70	1100	40	6052	24
0092	61,65	1101	40	6053	24
0095	75	1250	15	6054	24
0145	67	1300	20	6055	24
0167 Cover	11,13,14,35	13 112	16,17	6056	24
0177	71	13 208	16	6057	24
0180 Neon	71	13 211	17	6058	24
0180 Cover	13,14	1350	26	6059	24
0188 Cover	16,17	1353	26	6060	24
0195	67,72	1484	26	6061	24
0196	72	1487	26	6062	24
0232	63,65	1500	20	6066	24
0233	72	1500 Twin units	28	6067	24
0234	72	1501	20	6068	24
0245	67	1502	20	6090	24
0273	68,69	1510	20,28	6091	24
0275	69	1511	20	6092	24
0276	69	1520	20,28	7000	38
0277	69	1521	20	7001	38
0278	68	1522	20	7003	38
0279	61,65	1550	26	7004	38
0305	53	1551	26	7030	38,73
0306	53	1552	26	7050	38
0307	53	1553	26	7051	38
0308	53	1560	26	7053	38
0320	52	1561	26	7054	38
0323	42	1562	26	8200	36
0327	47	1570	26	8201	36
0331	61,65	1571	26	8250	36
0332	82	1572	26	8251	36
0333	82	1700	64	8300	34
0340	82	1710	64	8300 Vandal	44
0341	82	1710 Guard	63	8301	34
0345	83	1720	64	8301 Vandal	44
0347	83	1721	64	8303	34
0413	78	1722	64	8304	34
0430	20,73	1750	64	8350	34
0430 Twin units	28	1760	64	8350 Vandal	44
0434	21,23	1770	64	8351	34
0441	27	1911	43	8351 Vandal	44
0445	78	1961	43	8353	34
0480	26,73	22--	30-33	8354	34
0494	23,27,29	23--	30-33	8500	10
0506	61,65	24--	30-31	8500 Push	35
0520	82	25--	30-31	8503	10
0539	61,63,65	2760	69	8550	10
0568	68	2820	70	8550 Semi Rotary	11
0569	68	2821	70	8553	10
0579	71	2870	70	8580	10,73
0581	72	290-- Snap action	48	8600	12
0582	72	2950	67	8601	12
0586	70	2951	68	8602	12
0589	70	3005	55	8610	12
0600	61	3006	55	8611	12
0602	61	3101	56	8620	14
0616	27	3102	56	8630	12,73
0707	79	3111	56	8634	13
0708	79	3130	74	8650	12
0709	79	3141	57	8651	12
0710	79	3145	57	8652	12
0711	79	3146	57	8653	12
0717	80	3147	57	8660	12
0721	81	3160	74	8661	12
0722	81	3161	74	8670	14
0723	81	3221	74	8800	8
0873	83	340- Snap action	50	8800 Twin units	8
0910	42	390- Snap action	50	8801	8
0911	42,45	3900 Series	62	8802	8
0911 Vandal	42,45	3950 Series	62	9000	60
0916	41	4102	46	9100	58
0917	41	5500	22		
0918	41	5500 Twin units	23		

Conditions of sale

For the purposes of the following Conditions of Sale, the words "The Company" refer to Arcoelectric Switches plc.

CATALOGUES Catalogues, price lists and other advertising matter are an indication of the type of goods offered and no prices or other particulars contained therein shall be binding.

PRICES Quotations are open for acceptance within 30 days. Prices on orders issued within that period are guaranteed firm for three months from the date of formal acknowledgement. Deliveries extending beyond the initial six months will be invoiced at the prices shown in the Company's then current price list.

Notwithstanding any clauses attached to Customers' orders, the Company's formal acceptance of the order is made on the understanding that this clause applies and is accepted by the Customer unless expressly waived, in writing, by the Company.

PAYMENT Unless otherwise agreed in writing, payment in full is due immediately in respect of any goods delivered. Until payment is made in full, the goods shall remain the property of the Company, but the risk therein and all liability to third parties in respect thereof shall pass to the customer on delivery.

SETTLEMENT Credit terms can be arranged for customers taking regular deliveries of goods, such payment terms are 30 days from date of invoice, or such other terms as agreed and are strictly nett. For infrequent purchases and/or low value orders payment against a pro-forma invoice is required.

No discount is allowed for early payment or payment against a pro-forma invoice. Failure to pay in accordance with these terms will result in the Company instructing a third party to obtain settlement. Any costs incurred thereby will be charged to the Customer. The Company reserves the right to charge interest on overdue debts at a rate of 4% above HSBC Bank base rate.

DESPATCH Any times quoted for despatch are to be treated as estimates only and the Company shall not be liable for failure to despatch within such time. In all cases, whether a time for despatch be quoted or not, the time for despatch shall be extended by a reasonable period if delay in despatch is caused by instructions or lack of instructions from the Customer or by industrial dispute, or by any cause whatsoever beyond the reasonable control of the Company.

MINIMUM ORDER QUANTITY Please discuss your likely batch quantity requirements with our Sales department prior to ordering. On some items, ie coloured switches or special printing, MOQ's of 1000 or more may apply.

CARRIAGE The Company reserves the right to make nominal charges for handling, packaging and carriage on all orders.

DAMAGE OR LOSS IN TRANSIT If the Customer wishes the Company to make a claim on the carriers for a parcel damaged in transit, the Customer must notify the carriers and the Company within 3 working days of receipt. If a consignment fails to arrive within ten working days of the Customers' receipt of an advice note and invoice from the Company, the Customer should immediately notify the carrier and the Company. Claims can only be considered if made within this period. Shortage claims on consignments not damaged in transit should be made within seven working days.

REJECTION Unless otherwise agreed, goods rejected by the Customer as not complying with the contract must be advised within 7 working days of receipt.

DEFECTS AFTER DELIVERY The Company will make good by repair, or at the Company's option, by the supply of a replacement, defects which under proper use, appear in the goods within a period of twelve calendar months after the goods have been delivered, and arise solely from faulty design, workmanship or materials, always provided that the defective parts have been returned to the Company if it be so required.

The liability of the Company under this clause shall be in lieu of any warranty or condition implied by the law as to the quality or fitness for any particular purpose of the goods, and save as provided in this clause the Company shall not be under any liability, whether in contract, tort or otherwise, in respect of defects in goods delivered or for any injury (other than personal injury caused by the Company's negligence as defined in Section 1 of the Unfair Contract Terms Act 1977), damage or loss resulting from such defect or from any work done in connection therewith. Provided however, that nothing in this clause shall operate to exclude any warranty or condition implied by law as to the quality of the goods in the event that the goods when sold by the Customer or when sold by any person or persons to whom the Customer may sell the goods shall become the subject of a consumer sale as defined in the Supply of Goods (Implied Terms) Act 1973, except to the extent that any claim under such warranty or condition shall have arisen from any act or omission by the Customer or by any other person or persons selling the goods by way of a consumer sale.

UK HEALTH AND SAFETY ACT 1974 Detailed approval information is available on application. Approvals do not always cover every version of a component. Switches with metal levers (or metal fixing systems) do not comply with the latest standards on safety unless the fixing plate is reliably earthed. Product descriptions are, of necessity, abridged and users should always give full details of electrical load and environmental conditions so that a check can be made that the component is suitable for the application. Switch ratings are, unless otherwise stated, resistive at 250 Vac, T55. Transparent lenses on signal lamps, neon indicators and lit switches are moulded in polycarbonate, a material which is attacked by hydrocarbons.

ARBITRATION If at any time any question, dispute or difference whatsoever shall arise between the Customer and the Company in relation to or in connection with the contract, either party may give to the other party notice in writing of the existence of such question, dispute or difference and the same shall be referred to the arbitration of a third party to be mutually agreed upon, or failing agreement within 14 days of receipt of such notice, a party appointed by the president, at the time, of the UK organisation known as the Federation of British Electrotechnical and Allied Manufacturers' Associations. Any legal recourse requiring judiciary judgement shall take place through the courts and country of the Company's choice.

LEGAL CONSTRUCTION Unless otherwise agreed in writing, the contract shall in all aspects be construed and operate as an English contract and in conformity with English law.

STATUTORY AND OTHER REGULATIONS If the cost to the Company of performing its obligations under the contract, be increased or reduced by reason of the making or amendment after the date of tender of any law or of any order, regulation, or bye-law having the force of law that shall affect the performance of the Company's obligations under the contract, the amount of such increase or reduction shall be added to or deducted from the contract price as the case may be.

OVER RUNS Where products are manufactured as special for a Customer, for instance colour, marking or circuit, the Company reserves the right to despatch up to a maximum of 5% excess at the end of the order or at the completion of the schedule.

X-ON Electronics

Largest Supplier of Electrical and Electronic Components

Click to view similar products for [Toggle Switches](#) category:

Click to view products by [Arcoelectric](#) manufacturer:

Other Similar products are found below :

[A19HV](#) [8A1-C-222](#) [60012L](#) [6006L](#) [6663](#) [7101MD9V30GE](#) [7101SPDV30BE](#) [7103SDV30BE](#) [7105D](#) [7108P3YAV2BE](#) [71YY50282](#)
[7201MD9AVBE](#) [7301K38](#) [7306K36](#) [7310K36](#) [7314K36](#) [7506K4](#) [7592K6](#) [7691K14](#) [7700K1](#) [8396K108](#) [8824K14](#) [8828K13](#) [G2VX](#) [G3VX](#)
[PS83-121G](#) [A101MD9AB04](#) [A101SD9AB04](#) [A101SDCQ04](#) [A103SD9AQ04](#) [A107TZB04](#) [A123P32YZQ](#) [A123S1YZG](#) [A127S1YCQ](#) [1-](#)
[1825192-0](#) [A131S1YZQ](#) [A201SCWZB04](#) [A207SYCB04](#) [A208J61ZQ0004](#) [A221K12KAG](#) [A221S1YZQ](#) [A221T1TCQ](#) [A232K12KZQ](#)
[A232M1YCQ](#) [A323S1CWZQ](#) [A423S1CWZG-M8](#) [A423S1YZQ](#) [12149A-3V](#) [12156AX408](#) [12147AGKX679](#)