

Notice for TAIYO YUDEN products

Please read this notice before using the TAIYO YUDEN products.



REMINDERS

- Product information in this catalog is as of October 2008. All of the contents specified herein are subject to change without notice due to technical improvements, etc. Therefore, please check for the latest information carefully before practical application or usage of the Products.

Please note that Taiyo Yuden Co., Ltd. shall not be responsible for any defects in products or equipment incorporating such products, which are caused under the conditions other than those specified in this catalog or individual specification.

- Please contact Taiyo Yuden Co., Ltd. for further details of product specifications as the individual specification is available.
- Please conduct validation and verification of products in actual condition of mounting and operating environment before commercial shipment of the equipment.
- All electronic components or functional modules listed in this catalog are developed, designed and intended for use in general electronics equipment.(for AV, office automation, household, office supply, information service, telecommunications, (such as mobile phone or PC) etc.). Before incorporating the components or devices into any equipment in the field such as transportation,(automotive control, train control, ship control), transportation signal, disaster prevention, medical, public information network (telephone exchange, base station) etc. which may have direct influence to harm or injure a human body, please contact Taiyo Yuden Co., Ltd. for more detail in advance.

Do not incorporate the products into any equipment in fields such as aerospace, aviation, nuclear control, submarine system, military, etc. where higher safety and reliability are especially required.

In addition, even electronic components or functional modules that are used for the general electronic equipment, if the equipment or the electric circuit require high safety or reliability function or performances, a sufficient reliability evaluation check for safety shall be performed before commercial shipment and moreover, due consideration to install a protective circuit is strongly recommended at customer's design stage.

- The contents of this catalog are applicable to the products which are purchased from our sales offices or distributors (so called "TAIYO YUDEN' s official sales channel").
It is only applicable to the products purchased from any of TAIYO YUDEN' s official sales channel.
- Please note that Taiyo Yuden Co., Ltd. shall have no responsibility for any controversies or disputes that may occur in connection with a third party's intellectual property rights and other related rights arising from your usage of products in this catalog. Taiyo Yuden Co., Ltd. grants no license for such rights.
- Caution for export
Certain items in this catalog may require specific procedures for export according to "Foreign Exchange and Foreign Trade Control Law" of Japan, "U.S. Export Administration Regulations," and other applicable regulations. Should you have any question or inquiry on this matter, please contact our sales staff.
Should you have any question or inquiry on this matter, please contact our sales staff.

大容量積層セラミックコンデンサ

HIGH VALUE MULTILAYER CERAMIC CAPACITORS

	Code	Temp.characteristics	Operating temp. range
OPERATING TEMP.	BJ	B	-25~+85°C
		X5R*	-55~+85°C
	B7	X7R	-55~+125°C
		F	-25~+85°C
F	Y5V	-30~+85°C	

*個別仕様の取交しにより、X7R仕様に対応している場合があります。

*We may provide X7R for some items according to the individual specification.



特長 FEATURES

- 電極にNi金属を使用し、端子電極部にメッキをしてあることにより、はんだ付け性および耐熱性にすぐれ、マイグレーションもほとんど発生せず、高い信頼性を示します
- 等価直列抵抗 (ESR) が小さく、ノイズ吸収性にすぐれています。
- 特にタンタルおよびアルミ電解コンデンサに比較した場合：
 - 高い許容リップル電流値
 - 高い定格電圧でありながら小型形状
 - 絶縁抵抗、破壊電圧が高く信頼性にすぐれている
 - 等の特徴があります

- The use of Nickel(Ni) as material for both the internal and external electrodes improves the solderability and heat resistance characteristics. This almost completely eliminates migration and raises the level of reliability significantly.
- Low equivalent series resistance(ESR) provides excellent noise absorption characteristics.
- Compared to tantalum or aluminum electrolytic capacitors these ceramic capacitors offer a number of excellent features, including:
 - Higher permissible ripple current values
 - Smaller case sizes relative to rated voltage
 - Improved reliability due to higher insulation resistance and breakdown voltage.

用途 APPLICATIONS

- デジタル回路全般
- 電源バイパスコンデンサ
 - 液晶モジュール用
 - 液晶駆動電圧ライン用
 - 電源電圧の高いLSI、IC、OPアンプ用
- 平滑コンデンサ
 - DC-DCコンバータ (入力、出力側用)
 - スイッチング電源 (2次側用)

- General digital circuit
- Power supply bypass capacitors
 - Liquid crystal modules
 - Liquid crystal drive voltage lines
 - LSI, IC, converters(both for input and output)
- Smoothing capacitors
 - DC-DC converters (both for input and output)
 - Switching power supplies (secondary side)

形名表記法 ORDERING CODE

1 定格電圧 (VDC)	3 端子電極	5 温度特性	7 容量許容差	9 個別仕様
A 4 J 6.3 L 10 E 16 T 25 G 35 U 50	K メッキ品	BJ B B7 X5R △F X7R Y5V	K ±10% M ±20% Z +80% -20%	- 標準
2 シリーズ名	4 形状寸法(EIA) L×W (mm)	6 公称静電容量 [pF]	8 製品厚み [mm]	10 包装
M 積層コンデンサ	107 (0603) 1.6×0.8 212 (0805) 2.0×1.25 316 (1206) 3.2×1.6 325 (1210) 3.2×2.5	例 473 47,000 105 1,000,000	K 0.45 A 0.8 D 0.85 F 1.15 G 1.25 H 1.5 L 1.6 N 1.9 Y 2.0max M 2.5	T φ178mm テーピング (4mmピッチ) 全形状 P φ178mm テーピング (4mmピッチ,1000個/リール) 325形状 厚み:M
				11 当社管理記号
				△ 標準品 △=スペース

J M K 3 1 6 B J 1 0 6 M L - T △

1 2 3 4 5 6 7 8 9 10 11

1 Rated voltage [VDC]	3 End termination	5 Temperature characteristics code	7 Capacitance tolerance	9 Special code
A 4 J 6.3 L 10 E 16 T 25 G 35 U 50	K Plated	BJ B B7 X5R △F X7R Y5V	K ±10% M ±20% Z +80% -20%	- Standard products
2 Series name	4 Dimensions [case size] (mm)	6 Nominal capacitance [pF]	8 Thickness (mm)	10 Packaging
M Multilayer ceramic capacitors	107 (0603) 1.6×0.8 212 (0805) 2.0×1.25 316 (1206) 3.2×1.6 325 (1210) 3.2×2.5	example 473 47,000 105 1,000,000	K 0.45 A 0.8 D 0.85 F 1.15 G 1.25 H 1.5 L 1.6 N 1.9 Y 2.0max M 2.5	T φ178mm Taping (4mm pitch) All types P φ178mm Taping (4mm pitch,1000pcs/reel) 1210Type Thickness:M
				11 Internal code
				△ Standard products △=Blank space

アイテム一覧 PART NUMBERS

107TYPE

【温度特性 Temp.char. BJ:B/X5R】

定格電圧 Rated Voltage	形名 Ordering code	EHS (Environmental Hazardous Substances)	公称 静電容量 Capacitance [μF]	温度特性 Temperature characteristics	tan δ Dissipation factor [%] Max.	実装条件 Soldering method R:リフロー Reflow soldering W: フロー Wave soldering	静電容量 許容差 Capacitance tolerance	厚み Thickness [mm]
35V	GMK107 BJ105□A*1	RoHS	1	B/X5R	5	R	±10%	0.8±0.1
	TMK107 BJ105□K*1	RoHS	1	X5R	10			0.45±0.05
25V	TMK107 BJ224□A	RoHS	0.22	B/X5R	3.5	R/W	±10%	0.8±0.1
	TMK107 BJ474□A*1	RoHS	0.47	B/X5R	3.5	R		0.8±0.1
	TMK107 BJ105□A*1	RoHS	1	B/X5R	5			0.8±0.1
	EMK107 BJ105□K*1	RoHS	1	X5R	10	R		0.45±0.05
16V	EMK107 BJ224□A	RoHS	0.22	B/X5R*2	3.5	R/W	±10%	0.8±0.1
	EMK107 BJ474□A	RoHS	0.47	B/X5R	3.5	R		0.8±0.1
	EMK107 BJ105□A*1	RoHS	1	B/X5R	5			0.8±0.1
	EMK107 BJ225□A*1	RoHS	2.2	B/X5R	10	R		0.8±0.1
	LMK107 BJ105□K*1	RoHS	1	B/X5R	10	R/W		0.45±0.05
	LMK107 BJ225□K*1	RoHS	2.2	X5R	10			0.45±0.05
10V	LMK107 BJ224□A	RoHS	0.22	B/X5R*2	3.5	R/W	±10%	0.8±0.1
	LMK107 BJ474□A	RoHS	0.47	B/X5R*2	3.5			0.8±0.1
	LMK107 BJ105□A*1	RoHS	1	B/X5R*2	5	0.8±0.1		
	LMK107 BJ225□A*1	RoHS	2.2	B/X5R	10	0.8±0.1		
	LMK107 BJ475□A*1	RoHS	4.7	X5R	10	0.8±0.1		
	JMK107 BJ474□K	RoHS	0.47	B/X5R	5	R		0.45±0.05
	JMK107 BJ105□K*1	RoHS	1	B/X5R	10			0.45±0.05
	JMK107 BJ225□K*1	RoHS	2.2	X5R	10			0.45±0.05
JMK107 BJ475MK*1,*3	RoHS	4.7	X5R	10	±20%		0.45±0.05	
JMK107 BJ225□A*1	RoHS	2.2	B/X5R	10	±10%		0.8±0.1	
JMK107 BJ475□A*1	RoHS	4.7	X5R	10	±20%		0.8±0.1	
6.3V	JMK107 BJ106MA*1,*3	RoHS	10	X5R	10	±20%	0.8+0.15/-0.1	
	AMK107 BJ225□K*1	RoHS	2.2	X5R	10	±10%	0.45±0.05	
	AMK107 BJ475MK*1	RoHS	4.7	X5R	10	±20%	0.45±0.05	
	AMK107 BJ106MA*1	RoHS	10	X5R	10	±20%	0.8±0.1	
4V	AMK107 BJ226MA*1,*3	RoHS	22	X5R	10	±20%	0.8±0.2	

形名の□には静電容量許容差記号が入ります。

*1 高温負荷試験の試験電圧は定格電圧の1.5倍

*2 個別仕様の取扱いにより、X7R仕様に対応している場合があります。

*3 ご使用の回路や機器により、個別仕様の取り交わしが必要になります。
必ず正規販売チャンネルにお問い合わせください。

□ Please specify the capacitance tolerance code.

*1 Test Voltage of Loading at high temperature test is 1.5 time of the rated voltage.

*2 We may provide X7R for some items according to the individual specification.

*3 The exchange of individual specification is necessary depending on the application and circuit condition. Please contact Taiyo Yuden sales channel.

【温度特性 Temp.char. B7:X7R】

定格電圧 Rated Voltage	形名 Ordering code	EHS (Environmental Hazardous Substances)	公称 静電容量 Capacitance [μF]	温度特性 Temperature characteristics	tan δ Dissipation factor [%] Max.	実装条件 Soldering method R:リフロー Reflow soldering W: フロー Wave soldering	静電容量 許容差 Capacitance tolerance	厚み Thickness [mm]
16V	EMK107 B7 224□A*1	RoHS	0.22	X7R	3.5	R/W	±10%	0.8±0.1
	EMK107 B7 105□A*1	RoHS	1	X7R	5	R		0.8±0.1
10V	LMK107 B7 224□A	RoHS	0.22	X7R	3.5	R/W	±10%	0.8±0.1
	LMK107 B7 474□A	RoHS	0.47	X7R	3.5	R		0.8±0.1
	LMK107 B7 105□A*1	RoHS	1	X7R	5			0.8±0.1
6.3V	JMK107 B7 224□A	RoHS	0.22	X7R	3.5	R/W	±10%	0.8±0.1
	JMK107 B7 474□A	RoHS	0.47	X7R	3.5	R		0.8±0.1
	JMK107 B7 105□A*1	RoHS	1	X7R	5			0.8±0.1

形名の□には静電容量許容差記号が入ります。

*1 高温負荷試験の試験電圧は定格電圧の1.5倍

□ Please specify the capacitance tolerance code.

*1 Test Voltage of Loading at high temperature test is 1.5 time of the rated voltage.

【温度特性 Temp.char. F:F/Y5V】

定格電圧 Rated Voltage	形名 Ordering code		EHS (Environmental Hazardous Substances)	公称 静電容量 Capacitance 〔 μ F〕	温度特性 Temperature characteristics	$\tan \delta$ Dissipation factor 〔%〕Max.	実装条件 Soldering method R:リフロー- Reflow soldering W: フロ- Wave soldering	静電容量 許容差 Capacitance tolerance	厚み Thickness 〔mm〕
50V	UMK107 F104ZA		RoHS	0.1	F/Y5V	7	R/W	+80% -20%	0.8±0.1
25V	TMK107 F474ZA		RoHS	0.47	F/Y5V	7			0.8±0.1
	EMK107 F224ZA		RoHS	0.22	F/Y5V	7			0.8±0.1
16V	EMK107 F474ZA		RoHS	0.47	F/Y5V	7	R		0.8±0.1
	EMK107 F105ZA		RoHS	1	F/Y5V	16			0.8±0.1
	EMK107 F225ZA		RoHS	2.2	F/Y5V	16			0.8±0.1
10V	LMK107 F105ZA		RoHS	1	F/Y5V	16			0.8±0.1
	LMK107 F225ZA		RoHS	2.2	F/Y5V	16		0.8±0.1	

■ 212TYPE

【温度特性 Temp.char. BJ:B/X5R】

定格電圧 Rated Voltage	形名 Ordering code	EHS (Environmental Hazardous Substances)	公称 静電容量 Capacitance [μF]	温度特性 Temperature characteristics	tanδ Dissipation factor [%] Max.	実装条件 Soldering method R:リフロー Reflow soldering W: 70- Wave soldering	静電容量 許容差 Capacitance tolerance	厚み Thickness [mm]	
50V	UMK212 BJ104□G	RoHS	0.1	B/X5R*2	3.5	R/W	±10% ±20%	1.25±0.1	
	UMK212 BJ224□G*1	RoHS	0.22	B/X5R*2	3.5			1.25±0.1	
	UMK212 BJ474□G*1	RoHS	0.47	B/X5R	3.5			1.25±0.1	
	UMK212 BJ105□G*1	RoHS	1	X5R	5			1.25±0.1	
35V	GMK212 BJ474□G	RoHS	0.47	B/X5R	3.5	R		1.25±0.1	
	GMK212 BJ105□G*1	RoHS	1	B/X5R*2	3.5			1.25±0.1	
25V	TMK212 BJ474□D	RoHS	0.47	B/X5R	3.5	R		0.85±0.1	
	TMK212 BJ105□D	RoHS	1	B/X5R	5			0.85±0.1	
	TMK212 BJ105□G	RoHS	1	B/X5R	5			1.25±0.1	
	TMK212 BJ225□G*1	RoHS	2.2	B/X5R	5			1.25±0.1	
16V	TMK212 BJ475□G*1	RoHS	4.7	X5R	10	R		1.25±0.15	
	EMK212 BJ105□D	RoHS	1	B/X5R	5			R	0.85±0.1
	EMK212 BJ225□D	RoHS	2.2	B/X5R	5				0.85±0.1
	EMK212 BJ475□D*1,*3	RoHS	4.7	B/X5R	10			R/W	0.85±0.1
	EMK212 BJ105□G	RoHS	1	B/X5R*2	3.5				1.25±0.1
	EMK212 BJ225□G	RoHS	2.2	B/X5R*2	5			1.25±0.1	
	EMK212 BJ475□G*1	RoHS	4.7	B/X5R	5		1.25±0.15		
10V	EMK212 BJ106□G*1,*3	RoHS	10	X5R	10	R	1.25±0.15		
	LMK212 BJ475□K*1	RoHS	4.7	X5R	10		0.45±0.05		
	LMK212 BJ105□D	RoHS	1	B/X5R*2	3.5		0.85±0.1		
	LMK212 BJ225□D	RoHS	2.2	B/X5R	5		0.85±0.1		
	LMK212 BJ475□D	RoHS	4.7	B/X5R	10		0.85±0.1		
	LMK212 BJ106□D*1	RoHS	10	X5R	10		0.85±0.1		
	LMK212 BJ105□G	RoHS	1	B/X5R*2	3.5		R/W	1.25±0.1	
	LMK212 BJ225□G	RoHS	2.2	B/X5R*2	5		R	1.25±0.1	
	LMK212 BJ475□G	RoHS	4.7	B/X5R	5			1.25±0.15	
	LMK212 BJ106□G	RoHS	10	X5R	10			1.25±0.15	
	LMK212 BJ226MG*1,*3	RoHS	22	X5R	10			±20%	1.25±0.2
	JMK212 BJ475□K*1	RoHS	4.7	X5R	10			±10% ±20%	0.45±0.05
6.3V	JMK212 BJ106MK*1,*3	RoHS	10	X5R	10	R	±20%	0.45±0.05	
	JMK212 BJ475□D	RoHS	4.7	X5R	10		±10% ±20%	0.85±0.1	
	JMK212 BJ106□D	RoHS	10	X5R	10		±20%	0.85±0.1	
	JMK212 BJ226MD*1,*3	RoHS	22	X5R	10		±10% ±20%	1.25±0.15	
	JMK212 BJ475□G	RoHS	4.7	B/X5R	5		±10% ±20%	1.25±0.15	
	JMK212 BJ106□G	RoHS	10	X5R	10		±10% ±20%	1.25±0.15	
	JMK212 BJ226MG*1,*3	RoHS	22	X5R	10		±20%	1.25±0.15	
	JMK212 BJ476MG*1,*3	RoHS	47	X5R	10		±20%	1.25±0.2	
4V	AMK212 BJ226MD*1	RoHS	22	X5R	10		0.85±0.1		

形名の□には静電容量許容差記号が入ります。

*1 高温負荷試験の試験電圧は定格電圧の 1.5 倍

*2 個別仕様の取交しにより、X7R仕様に対応している場合があります。

*3 ご使用の回路や機器により、個別仕様の取り交わしが必要になります。
必ず正規販売チャンネルにお問い合わせください。

□ Please specify the capacitance tolerance code.

*1 Test Voltage of Loading at high temperature test is 1.5 time of the rated voltage.

*2 We may provide X7R for some items according to the individual specification.

*3 The exchange of individual specification is necessary depending on the application and circuit condition. Please contact Taiyo Yuden sales channel.

【温度特性 Temp.char. B7:X7R】

定格電圧 Rated Voltage	形名 Ordering code		EHS (Environmental Hazardous Substances)	公称 静電容量 Capacitance 〔μF〕	温度特性 Temperature characteristics	tan δ Dissipation factor 〔%〕Max.	実装条件 Soldering method R:リフロー- Reflow soldering W: 7口- Wave soldering	静電容量 許容差 Capacitance tolerance	厚み Thickness 〔mm〕
50V	UMK212 B7 104□G		RoHS	0.1	X7R	3.5	R/W	±10% ±20%	1.25±0.1
	UMK212 B7 224□G* ¹		RoHS	0.22	X7R	3.5			1.25±0.1
	UMK212 B7 474□G* ¹		RoHS	0.47	X7R	3.5			1.25±0.1
35V	GMK212 B7 105□G* ¹		RoHS	1	X7R	3.5	R		1.25±0.1
25V	TMK212 B7 105□G* ¹		RoHS	1	X7R	5	R		1.25±0.1
16V	EMK212 B7 474□D		RoHS	0.47	X7R	3.5	R/W		0.85±0.1
	EMK212 B7 105□D		RoHS	1	X7R	5	R		0.85±0.1
	EMK212 B7 105□G		RoHS	1	X7R	3.5	R/W		1.25±0.1
	EMK212 B7 225□G* ¹		RoHS	2.2	X7R	10	R		1.25±0.1
10V	LMK212 B7 105□D		RoHS	1	X7R	3.5	R/W		0.85±0.1
	LMK212 B7 105□G		RoHS	1	X7R	3.5	R/W	1.25±0.1	
	LMK212 B7 225□G		RoHS	2.2	X7R	5	R	1.25±0.1	
	LMK212 B7 475□G* ¹		RoHS	4.7	X7R	10	R/W	1.25±0.15	

形名の□には静電容量許容差記号が入ります。

□ Please specify the capacitance tolerance code.

*1 高温負荷試験の試験電圧は定格電圧の 1.5 倍

*1 Test Voltage of Loading at high temperature test is 1.5 time of the rated voltage.

【温度特性 Temp.char. F:F/Y5V】

定格電圧 Rated Voltage	形名 Ordering code		EHS (Environmental Hazardous Substances)	公称 静電容量 Capacitance 〔μF〕	温度特性 Temperature characteristics	tan δ Dissipation factor 〔%〕Max.	実装条件 Soldering method R:リフロー- Reflow soldering W: 7口- Wave soldering	静電容量 許容差 Capacitance tolerance	厚み Thickness 〔mm〕
50V	UMK212 F224ZD		RoHS	0.22	F/Y5V	7	R/W	+80% -20%	0.85±0.1
	UMK212 F474ZG		RoHS	0.47	F/Y5V	7			1.25±0.1
	UMK212 F105ZG		RoHS	1	F/Y5V	7			1.25±0.1
16V	EMK212 F225ZG		RoHS	2.2	F/Y5V	7	R		1.25±0.1
10V	LMK212 F225ZD		RoHS	2.2	F/Y5V	9	R		0.85±0.1
	LMK212 F475ZG		RoHS	4.7	F/Y5V	9			1.25±0.1
	LMK212 F106ZG		RoHS	10	F/Y5V	16			1.25±0.1
6.3V	JMK212 F475ZD		RoHS	4.7	F/Y5V	16	R		0.85±0.1
	JMK212 F106ZG		RoHS	10	F/Y5V	16			1.25±0.1

■ 316TYPE

【温度特性 Temp.char. BJ:B/X5R】

定格電圧 Rated Voltage	形名 Ordering code	EHS (Environmental Hazardous Substances)	公称 静電容量 Capacitance 〔μF〕	温度特性 Temperature characteristics	tan δ Dissipation factor 〔%〕Max.	実装条件 Soldering method R:リフロー Reflow soldering W: フロー Wave soldering	静電容量 許容差 Capacitance tolerance	厚み Thickness 〔mm〕	
50V	UMK316 BJ224□L	RoHS	0.22	B/X5R ^{*2}	2.5	R/W	±10% ±20%	1.6±0.2	
	UMK316 BJ474□L	RoHS	0.47	B/X5R ^{*2}	3.5			1.6±0.2	
	UMK316 BJ105□L	RoHS	1	B/X5R ^{*2}	3.5			1.6±0.2	
	UMK316 BJ475□L ^{*1}	RoHS	4.7	X5R	10			1.6±0.2	
25V	TMK316 BJ105□D	RoHS	1	B/X5R	3.5	R	±10% ±20%	0.85±0.1	
	TMK316 BJ225□D ^{*1}	RoHS	2.2	B/X5R	3.5			0.85±0.1	
	TMK316 BJ475□D ^{*1}	RoHS	4.7	X5R	5			0.85±0.1	
	TMK316 BJ225□L	RoHS	2.2	B/X5R ^{*2}	3.5			1.6±0.2	
	TMK316 BJ475□L ^{*1}	RoHS	4.7	B/X5R	5			1.6±0.2	
	TMK316 BJ106□L ^{*1}	RoHS	10	X5R	5			1.6±0.2	
	EMK316 BJ225□D	RoHS	2.2	B/X5R	3.5			R/W	0.85±0.1
	EMK316 BJ475□D	RoHS	4.7	X5R	5				0.85±0.1
16V	EMK316 BJ106□D ^{*1}	RoHS	10	X5R	10	R/W	±20%	0.85±0.1	
	EMK316 BJ105□F	RoHS	1	B/X5R ^{*2}	3.5			1.15±0.1	
	EMK316 BJ106□F ^{*1}	RoHS	10	X5R	10	R		1.15±0.1	
	EMK316 BJ225□L	RoHS	2.2	B/X5R ^{*2}	3.5	R/W		1.6±0.2	
	EMK316 BJ475□L	RoHS	4.7	B/X5R	5	R		1.6±0.2	
	EMK316 BJ106□L ^{*1}	RoHS	10	B/X5R	5			1.6±0.2	
	EMK316 BJ226ML ^{*1}	RoHS	22	B/X5R	10			±20%	1.6±0.2
	LMK316 BJ475□D	RoHS	4.7	B/X5R	5			±10%	0.85±0.1
10V	LMK316 BJ106□D	RoHS	10	B/X5R	10	R	±20%	0.85±0.1	
	LMK316 BJ226MD ^{*1,*3}	RoHS	22	X5R	10		±20%	0.85±0.1	
	LMK316 BJ106□L	RoHS	10	B/X5R	5		±10% ±20%	1.6±0.2	
	LMK316 BJ226ML ^{*1}	RoHS	22	B/X5R	10		±20%	1.6±0.2	
	LMK316 BJ476ML ^{*1,*3}	RoHS	47	X5R	10		±20%	1.6±0.2	
	JMK316 BJ106□D	RoHS	10	B/X5R	10		±10% ±20%	0.85±0.1	
6.3V	JMK316 BJ226MD ^{*1,*3}	RoHS	22	X5R	10	±20%	0.85±0.1		
	JMK316 BJ476MD ^{*1,*3}	RoHS	47	X5R	10			0.85±0.1	
	JMK316 BJ106□L	RoHS	10	B/X5R ^{*2}	5	±10% ±20%	1.6±0.2		
	JMK316 BJ226□L	RoHS	22	B/X5R	10		1.6±0.2		
	JMK316 BJ476ML ^{*3}	RoHS	47	X5R	10	±20%	1.6±0.2		
	JMK316 BJ107ML ^{*1,*3}	RoHS	100	X5R	10		1.6±0.2		
4V	AMK316 BJ107ML ^{*1}	RoHS	100	X5R	10	±20%	1.6±0.2		

形名の□には静電容量許容差記号が入ります。

*1 高温負荷試験の試験電圧は定格電圧の 1.5 倍

*2 個別仕様の取交しにより、X7R仕様に对应している場合があります。

*3 ご使用の回路や機器により、個別仕様の取り交わしが必要になります。
必ず正規販売チャンネルにお問い合わせください。

□ Please specify the capacitance tolerance code.

*1 Test Voltage of Loading at high temperature test is 1.5 time of the rated voltage.

*2 We may provide X7R for some items according to the individual specification.

*3 The exchange of individual specification is necessary depending on the application and circuit condition. Please contact Taiyo Yuden sales channel.

【温度特性 Temp.char. B7:X7R】

定格電圧 Rated Voltage	形名 Ordering code	EHS (Environmental Hazardous Substances)	公称 静電容量 Capacitance 〔μF〕	温度特性 Temperature characteristics	tan δ Dissipation factor 〔%〕Max.	実装条件 Soldering method R:リフロー Reflow soldering W: フロー Wave soldering	静電容量 許容差 Capacitance tolerance	厚み Thickness 〔mm〕
50V	UMK316 B7 224□L	RoHS	0.22	X7R	2.5	R/W	±10% ±20%	1.6±0.2
	UMK316 B7 474□L	RoHS	0.47	X7R	3.5			1.6±0.2
	UMK316 B7 105□L	RoHS	1	X7R	3.5			1.6±0.2
25V	TMK316 B7 224□F	RoHS	0.22	X7R	2.5	R	±10% ±20%	1.15±0.1
	TMK316 B7 105□L	RoHS	1	X7R	3.5			1.6±0.2
	TMK316 B7 225□L	RoHS	2.2	X7R	3.5			1.6±0.2
	TMK316 B7 106□L ^{*1}	RoHS	10	X7R	10			1.6±0.2
16V	EMK316 B7 105□F	RoHS	1	X7R	3.5	R/W	±10% ±20%	1.15±0.1
	EMK316 B7 225□L	RoHS	2.2	X7R	3.5			1.6±0.2
	EMK316 B7 106□L ^{*1}	RoHS	10	X7R	10			1.6±0.2
10V	LMK316 B7 225□L	RoHS	2.2	X7R	3.5	R/W	±10% ±20%	1.6±0.2
	LMK316 B7 475□L	RoHS	4.7	X7R	5			1.6±0.2
	LMK316 B7 106□L ^{*1}	RoHS	10	X7R	5			1.6±0.2
6.3V	JMK316 B7 106□L	RoHS	10	X7R	5	R	±20%	1.6±0.2

形名の□には静電容量許容差記号が入ります。

*1 高温負荷試験の試験電圧は定格電圧の 1.5 倍

□ Please specify the capacitance tolerance code.

*1 Test Voltage of Loading at high temperature test is 1.5 time of the rated voltage.

【温度特性 Temp.char. F:F/Y5V】

定格電圧 Rated Voltage	形名 Ordering code	EHS (Environmental Hazardous Substances)	公称 静電容量 Capacitance 〔μF〕	温度特性 Temperature characteristics	tan δ Dissipation factor 〔%〕Max.	実装条件 Soldering method R:リフロー- Reflow soldering W: 7口- Wave soldering	静電容量 許容差 Capacitance tolerance	厚み Thickness 〔mm〕
50V	UMK316 F225ZG	RoHS	2.2	F/Y5V	7	R/W	+80% -20%	1.25±0.1
35V	GMK316 F475ZG	RoHS	4.7	F/Y5V	7	R		1.25±0.1
	GMK316 F106ZL	RoHS	10	F/Y5V	9			1.6±0.2
25V	TMK316 F106ZL	RoHS	10	F/Y5V	9			1.6±0.2
16V	EMK316 F106ZL	RoHS	10	F/Y5V	9			1.6±0.2
10V	LMK316 F475ZD	RoHS	4.7	F/Y5V	9			0.85±0.1
	LMK316 F106ZF	RoHS	10	F/Y5V	16			1.15±0.1
	LMK316 F226ZL	RoHS	22	F/Y5V	16			1.6±0.2
6.3V	JMK316 F106ZD	RoHS	10	F/Y5V	16			0.85±0.1

■ 325TYPE

【温度特性 Temp.char. BJ:B/X5R】

定格電圧 Rated Voltage	形名 Ordering code	EHS (Environmental Hazardous Substances)	公称 静電容量 Capacitance 〔μF〕	温度特性 Temperature characteristics	tan δ Dissipation factor 〔%〕Max.	実装条件 Soldering method R:リフロー- Reflow soldering W: 7口- Wave soldering	静電容量 許容差 Capacitance tolerance	厚み Thickness 〔mm〕
50V	UMK325 BJ105□H	RoHS	1	B/X5R*2	3.5	R/W	±10% ±20%	1.5±0.1
	UMK325 BJ475MM*1	RoHS	4.7	X5R	5	R		2.5±0.2
	UMK325 BJ106MM*1	RoHS	10	X5R	5			2.5±0.2
35V	GMK325 BJ225MN	RoHS	2.2	B/X5R	3.5			1.9±0.2
	GMK325 BJ475MN*1	RoHS	4.7	X5R	10			1.9±0.2
	GMK325 BJ106MN*1	RoHS	10	B/X5R	5			1.9±0.2
25V	TMK325 BJ106MD*1	RoHS	10	B/X5R	5			0.85±0.1
	TMK325 BJ225MH	RoHS	2.2	B/X5R*2	3.5			1.5±0.1
	TMK325 BJ335MN	RoHS	3.3	B/X5R*2	3.5			1.9±0.2
	TMK325 BJ475MN	RoHS	4.7	B/X5R*2	3.5			1.9±0.2
	TMK325 BJ106MN	RoHS	10	B/X5R	5		1.9±0.2	
	TMK325 BJ106MM*1	RoHS	10	B/X5R	3.5	2.5±0.2		
16V	EMK325 BJ106MD*1	RoHS	10	B/X5R	5	0.85±0.1		
	EMK325 BJ226MD*1,*3	RoHS	22	B/X5R	10	0.85±0.1		
	EMK325 BJ475MN	RoHS	4.7	B/X5R*2	3.5	1.9±0.2		
	EMK325 BJ106MN	RoHS	10	B/X5R	3.5	1.9±0.2		
	EMK325 BJ226MM*1	RoHS	22	B/X5R	5	2.5±0.2		
	EMK325 BJ476MM*1	RoHS	47	X5R	10	2.5±0.2		
10V	LMK325 BJ335MD	RoHS	3.3	B/X5R	3.5	0.85±0.1		
	LMK325 BJ475MD	RoHS	4.7	B/X5R	5	0.85±0.1		
	LMK325 BJ106MD*1	RoHS	10	B/X5R	5	0.85±0.1		
	LMK325 BJ226MY*1	RoHS	22	B/X5R	5	1.9+0.1/-0.2		
	LMK325 BJ106MN	RoHS	10	B/X5R*2	3.5	1.9±0.2		
	LMK325 BJ226MM	RoHS	22	B/X5R	5	2.5±0.2		
	LMK325 BJ476MM*1	RoHS	47	X5R	10	2.5±0.2		
	LMK325 BJ107MM*1,*3	RoHS	100	X5R	10	2.5±0.3		
6.3V	JMK325 BJ226MY	RoHS	22	B/X5R	5	1.9+0.1/-0.2		
	JMK325 BJ107MY*1,*3	RoHS	100	X5R	10	1.9+0.1/-0.2		
	JMK325 BJ476MN*1	RoHS	47	X5R	10	1.9±0.2		
	JMK325 BJ476MM*1	RoHS	47	X5R	10	2.5±0.2		
	JMK325 BJ107MM*1	RoHS	100	X5R	10	2.5±0.3		

形名の□には静電容量許容差記号が入ります。

*1 高温負荷試験の試験電圧は定格電圧の 1.5 倍

*2 個別仕様の取交しにより、X7R仕様に対応している場合があります。

*3 ご使用の回路や機器により、個別仕様の取交しが必要になります。

必ず正規販売チャンネルにお問い合わせください。

□ Please specify the capacitance tolerance code.

*1 Test Voltage of Loading at high temperature test is 1.5 time of the rated voltage.

*2 We may provide X7R for some items according to the individual specification.

*3 The exchange of individual specification is necessary depending on the application and circuit condition. Please contact Taiyo Yuden sales channel.

アイテム一覧 PART NUMBERS

【温度特性 Temp.char. B7:X7R】

定格電圧 Rated Voltage	形名 Ordering code	EHS (Environmental Hazardous Substances)	公称 静電容量 Capacitance [μ F]	温度特性 Temperature characteristics	tan δ Dissipation factor [%] Max.	実装条件 Soldering method R:リフロー Reflow soldering W: フロー Wave soldering	静電容量 許容差 Capacitance tolerance	厚み Thickness [mm]
50V	UMK325 B7 105□H	RoHS	1	X7R	3.5	R/W	$\pm 10\%$ $\pm 20\%$	1.5 \pm 0.1
25V	TMK325 B7 225MH	RoHS	2.2	X7R	3.5	R	$\pm 20\%$	1.5 \pm 0.1
	TMK325 B7 335MN	RoHS	3.3	X7R	3.5			1.9 \pm 0.2
	TMK325 B7 475MN* ¹	RoHS	4.7	X7R	3.5			1.9 \pm 0.2
	TMK325 B7 106MN* ¹	RoHS	10	X7R	5			1.9 \pm 0.2
16V	EMK325 B7 475MN	RoHS	4.7	X7R	3.5			1.9 \pm 0.2
10V	LMK325 B7 106MN	RoHS	10	X7R	3.5			1.9 \pm 0.2

形名の□には静電容量許容差記号が入ります。

*1 高温負荷試験の試験電圧は定格電圧の 1.5 倍

□ Please specify the capacitance tolerance code.

*1 Test Voltage of Loading at high temperature test is 1.5 time of the rated voltage.

【温度特性 Temp.char. F:F/Y5V】

定格電圧 Rated Voltage	形名 Ordering code	EHS (Environmental Hazardous Substances)	公称 静電容量 Capacitance [μ F]	温度特性 Temperature characteristics	tan δ Dissipation factor [%] Max.	実装条件 Soldering method R:リフロー Reflow soldering W: フロー Wave soldering	静電容量 許容差 Capacitance tolerance	厚み Thickness [mm]
50V	UMK325 F475ZH	RoHS	4.7	F/Y5V	7	R	+80% -20%	1.5 \pm 0.1
35V	GMK325 F106ZH	RoHS	10	F/Y5V	7			1.5 \pm 0.1
16V	EMK325 F226ZN	RoHS	22	F/Y5V	16			1.9 \pm 0.2
10V	LMK325 F106ZF	RoHS	10	F/Y5V	16			1.15 \pm 0.1
	LMK325 F226ZN	RoHS	22	F/Y5V	16			1.9 \pm 0.2
6.3V	JMK325 F476ZN	RoHS	47	F/Y5V	16			1.9 \pm 0.2

インピーダンス・ESR-周波数特性例 Example of Impedance ESR vs. Frequency characteristics

・当社積層セラミックコンデンサ例 (Taiyo Yuden multilayer ceramic capacitor)

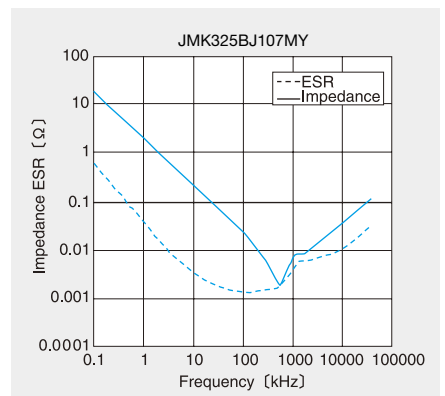
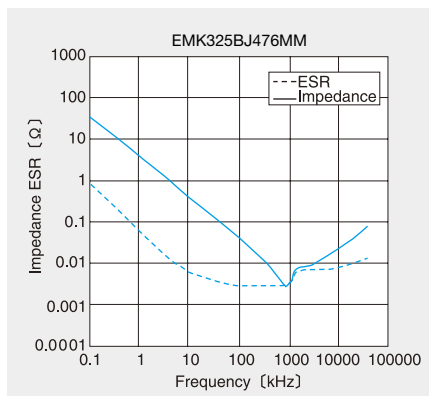
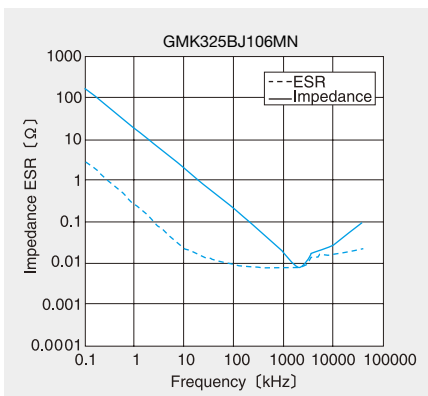
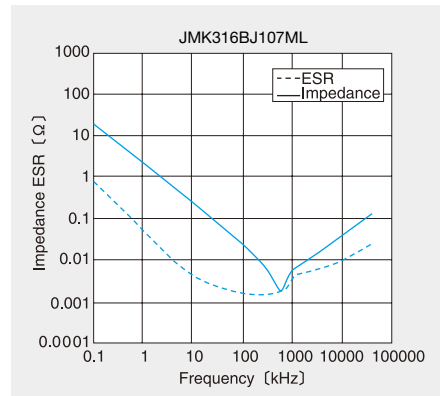
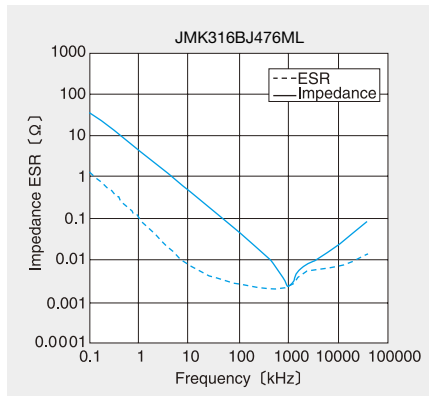
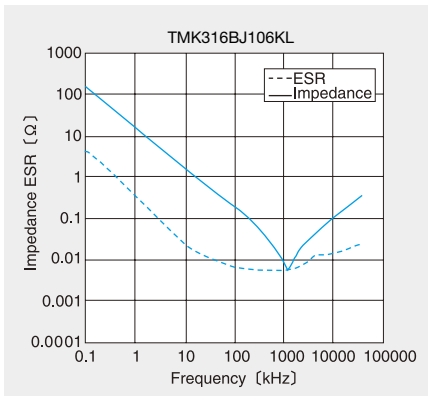
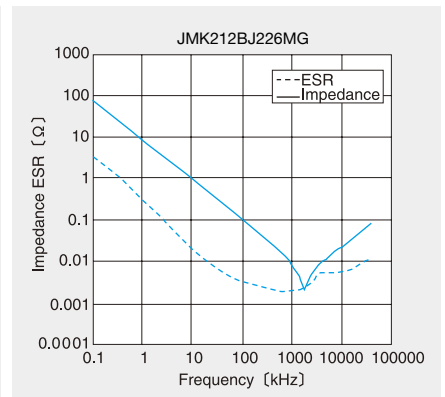
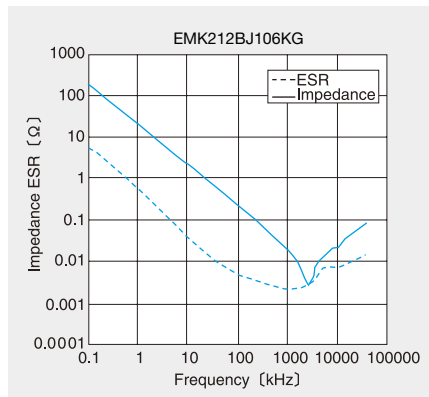
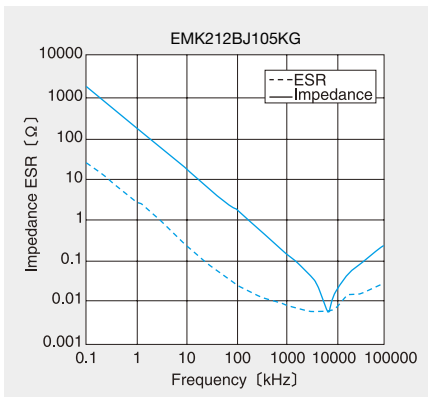
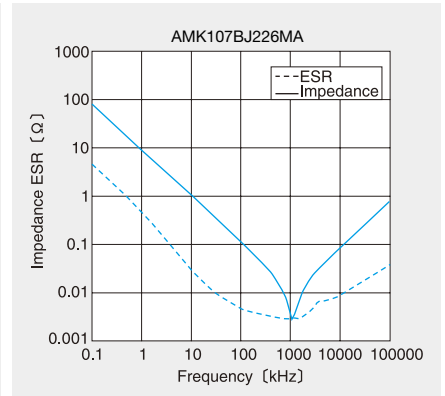
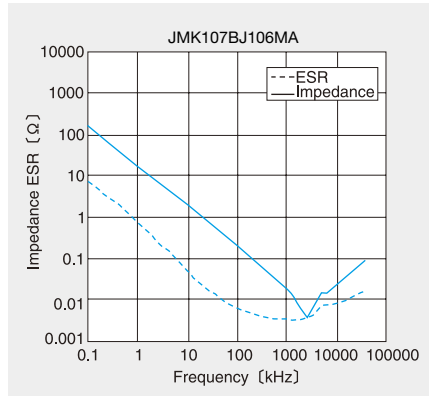
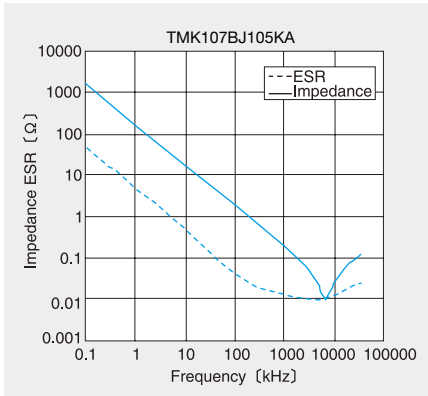

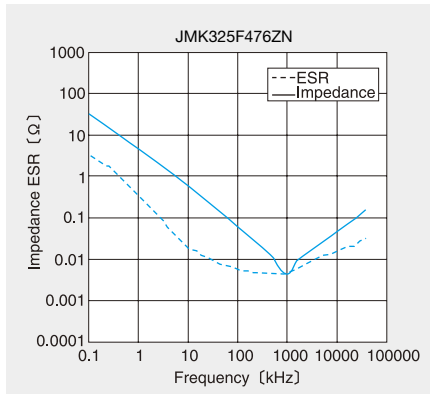
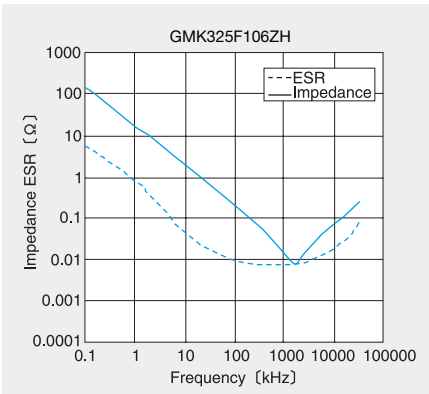
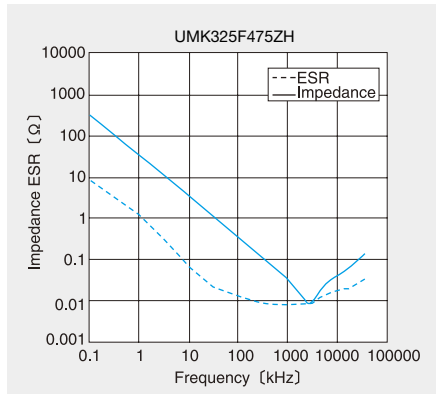
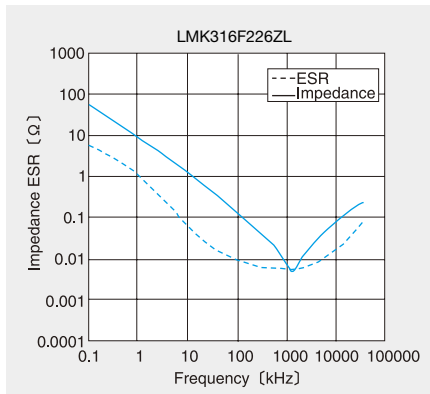
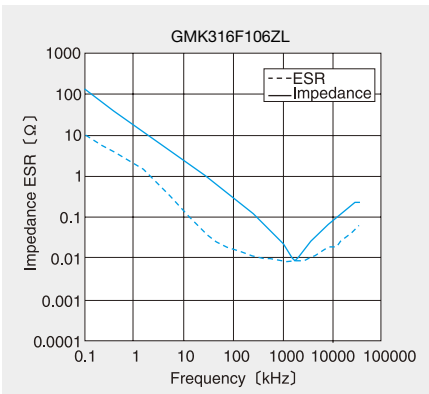
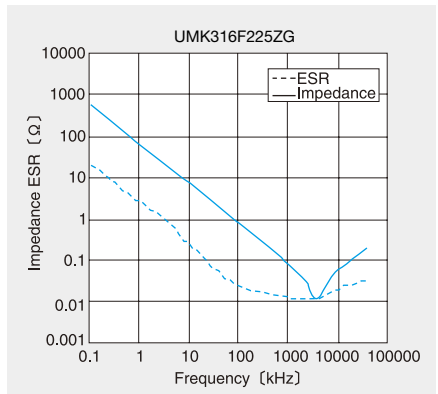
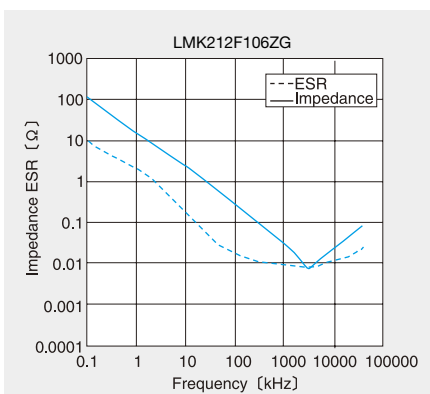
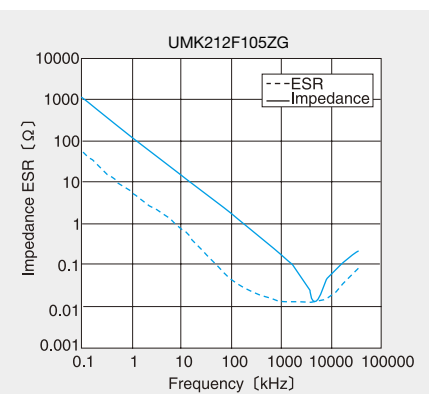
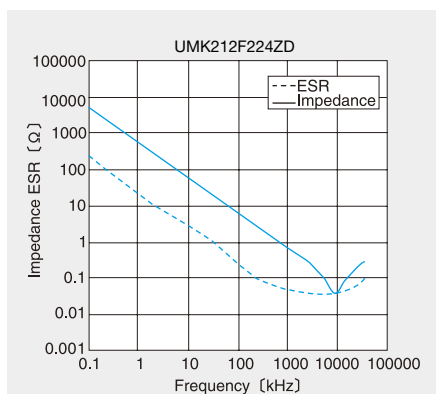
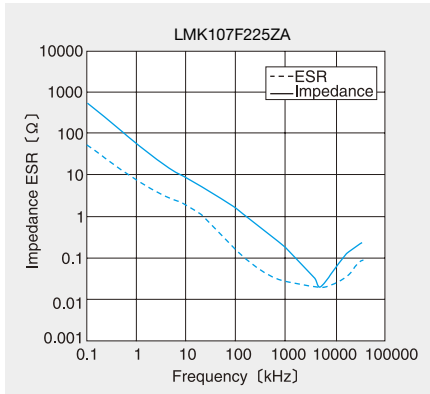
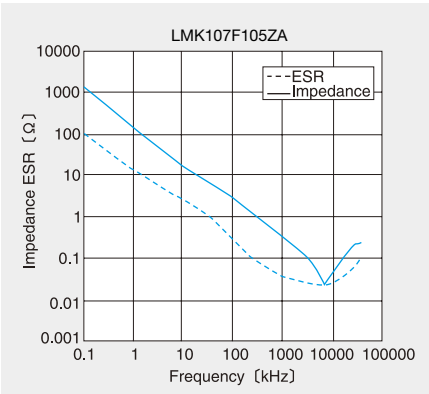
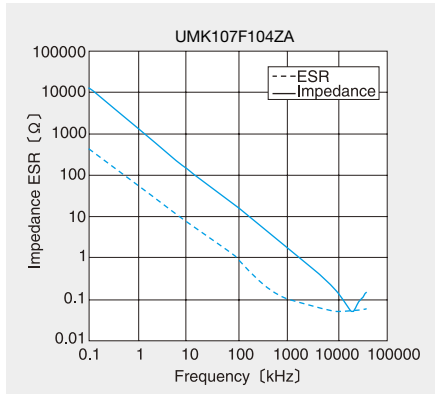

一般積層セラミックコンデンサ (温度補償用・Class 1) STANDARD MULTILAYER CERAMIC CAPACITORS (CLASS1 : TEMPERATURE COMPENSATING DIELECTRIC TYPE)

OPERATING TEMP. -55~+125°C



リフロー/REFLOW

特長 FEATURES

- ・実装密度の向上が図れます
- ・モノリシックの構造のため、信頼性が高い
- ・同一形状、静電容量範囲が広い
- ・ Improve Higher Mounting Densities.
- ・ Multilayer block structure provides higher reliability
- ・ A wide range of capacitance values available in standard case sizes.

用途 APPLICATIONS

- ・ 一般電子機器用
- ・ 通信機器用 (携帯電話、PHS、コードレス電話 etc.)
- ・ General electronic equipment
- ・ Communication equipment (cellular phone, PHS, other wireless applications, etc.)

形名表記法 ORDERING CODE

1 定格電圧 [VDC]	4 形状寸法 (EIA) L×W [mm]	6 公称静電容量 [pF]	7 容量許容差	9 個別仕様
E 16 T 25 U 50	042 (01005) 0.4×0.2 063 (0201) 0.6×0.3 105 (0402) 1.0×0.5	例 0R5 0.5 010 1 100 10 ※R=小数点	C ± 0.25 pF D ± 0.5 pF F ± 1 pF J ± 5 % K ± 10 %	- 標準
2 シリーズ名	5 温度特性 [ppm/°C]	8 製品厚み [mm]	10 包装	11 当社管理記号
M 積層コンデンサ	C□ 0 : CG, CH, CJ, CK R□ -220 : RH, S□ -330 : SH, SJ, SK G ±30 T□ -470 : TJ, TK H ±60 U□ -750 : UJ, UK J ±120 SL +350~-1000 K ±250 □=許容差	C 0.2 P 0.3 V 0.5 W 0.5	F φ178mm テーピング (2mmピッチ)	△ 標準品 △=スペース

U M K 1 0 5 C H 1 0 1 J V - F △

1 Rated voltage [VDC]	4 Dimensions (case size) [EIA] L×W [mm]	6 Nominal capacitance [pF]	7 Capacitance tolerance	9 Special code
E 16 T 25 U 50	042 (01005) 0.4×0.2 063 (0201) 0.6×0.3 105 (0402) 1.0×0.5	example 0R5 0.5 010 1 100 10 *R=decimal point	C ± 0.25 pF D ± 0.5 pF F ± 1 pF J ± 5 % K ± 10 %	- Standard Products
2 Series name	5 Temperature characteristics [ppm/°C]	8 Thickness [mm]	10 Packaging	11 Internal code
M Multilayer ceramic capacitor	C□ 0 : CG, CH, CJ, CK R□ -220 : RH, S□ -330 : SH, SJ, SK G ±30 T□ -470 : TJ, TK H ±60 U□ -750 : UJ, UK J ±120 SL +350~-1000 K ±250 □=Tolerance	C 0.2 P 0.3 V 0.5 W 0.5	F φ178mm Taping (2mm pitch)	△ Standard Products △=Blank space

外形寸法 EXTERNAL DIMENSIONS

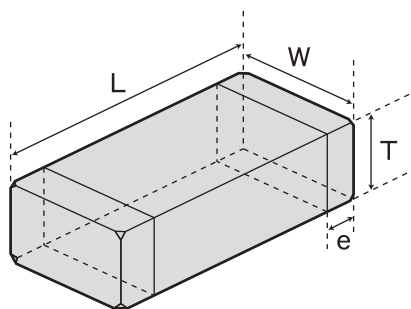

Type (EIA)	L	W	T		e
□MK042 (01005)	0.4±0.02 (0.016±0.001)	0.2±0.02 (0.008±0.001)	0.2±0.02 (0.008±0.001)	C	0.1±0.03 (0.004±0.001)
□MK063 (0201)	0.6±0.03 (0.024±0.001)	0.3±0.03 (0.012±0.001)	0.3±0.03 (0.012±0.001)	P	0.15±0.05 (0.006±0.002)
□MK105 (0402)	1.0±0.05 (0.039±0.002)	0.5±0.05 (0.020±0.002)	0.5±0.05 (0.020±0.002)	W, V	0.25±0.10 (0.010±0.004)

Unit : mm (inch)

概略バリエーション AVAILABLE CAPACITANCE RANGE

Cap [pF]	Type	042	063	105					
	Temp.char.	C□	C□ U□	C□	U□	SL	R□	S□	T□
	VDC [pF:3digits]	16V	25V	50V					
0.5	0R5								
1	010								
1.5	1R5								
2	020								
3	030								
4	040								
5	050								
6	060								
7	070								
8	080								
9	090								
10	100	C	P						
12	120								
15	150								
18	180								
22	220								
27	270								
33	330								
39	390								
47	470								
56	560								
68	680								
82	820								
100	101								
120	121								
150	151								
180	181								
220	221								
270	271								
330	331								
390	391								
470	471								
560	561								
680	681								
820	821								
1000	102								

注:グラフの記号は製品の厚み記号です。

Note: Letters in the table indicate thickness.

温度特性 Temperature Characteristics

温度特性 Temperature char. (EIA)	温度係数範囲 (ppm/°C) ※1 Temperature coefficient range	使用温度範囲 Operating Temp. range
C K (C0K)	0±250	-55~+125°C
C J (C0J)	0±120	
C H (C0H)	0±60	
C G (C0G)	0±30	
R H (R2H)	-220±60	
S K (S2K)	-330±250	
S J (S2J)	-330±120	
S H (S2H)	-330±60	
T K (T2K)	-470±250	
T J (T2J)	-470±120	
U K (U2K)	-750±250	
U J (U2J)	-750±120	
S L	-1000~+350	

※1: 20°Cにおける静電容量を基準。
Based on the capacitance at 20°C

静電容量許容差 Capacitance Tolerance Symbol

記号 Symbol	許容差 Tolerance	区分 Item
C	±0.25pF	~5pF
D	±0.5 pF	~10pF
F	±1pF	6~10 pF
J	±5 %	11pF~
K	±10 %	11pF~

Q

Q※2 Symbol	区分 Item
≥400+20・C※1	~27pF
≥1000	30pF~

※1: C=公称静電容量 Nominal capacitance(pF)

※2: 測定周波数 Measurement Frequency= 1±0.1MHz (C≤1000pF)
1±0.1kHz (C>1000pF)

測定電圧 Measurement voltage = 0.5~5Vrms (C≤1000pF)
1±0.2Vrms (C>1000pF)

セレクションガイド
Selection Guide

アイテム一覧
Part Numbers

特性図
Electrical Characteristics

梱包
Packaging

信頼性
Reliability Data

使用上の注意
Precautions



etc

042TYPE

Class 1

定格電圧 Rated Voltage (DC)	形名 Ordering code	EHS (Environmental Hazardous Substances)	温度特性 Temperature characteristics (EIA)																	公称静電 容 量 Capacitance [pF]	静電容量 許容差 Capacitance tolerance	厚み Thicknees [mm] (inch)
			CK (C0K)	CJ (C0J)	CH (C0H)	CG (C0G)	PK (P2K)	PJ (P2J)	PH (P2H)	RK (R2K)	RJ (R2J)	RH (R2H)	SK (S2K)	SJ (S2J)	SH (S2H)	TK (T2K)	TJ (T2J)	TH (T2H)	UK (U2K)			
16V	EMK042 CK0R5□C	RoHS	●																	0.5	±0.25pF	0.2±0.02 (0.008±0.001)
	EMK042 CK010□C	RoHS	●																	1		
	EMK042 CK1R5□C	RoHS	●																	1.5		
	EMK042 CK020□C	RoHS	●																	2		
	EMK042 CJ030□C	RoHS		●																3		
	EMK042 CH040□C	RoHS			●															4		
	EMK042 CH050□C	RoHS			●															5		
	EMK042 CH060□C	RoHS			●															6		
	EMK042 CH070□C	RoHS			●															7		
	EMK042 CH080□C	RoHS			●															8		
	EMK042 CH090□C	RoHS			●															9		
	EMK042 CH100□C	RoHS			●															10		
	EMK042 CH120□C	RoHS			●															12		
	EMK042 CH150□C	RoHS			●															15		
	EMK042 CH180□C	RoHS			●															18		
	EMK042 CH220□C	RoHS			●															22		
	EMK042 CH270□C	RoHS			●															27		
	EMK042 CH330□C	RoHS			●															33		
	EMK042 CH390□C	RoHS			●															39		
	EMK042 CH470□C	RoHS			●															47		
EMK042 CH560□C	RoHS			●															56			
EMK042 CH680□C	RoHS			●															68			
EMK042 CH820□C	RoHS			●															82			
EMK042 CH101□C	RoHS			●															100			

注:形名の□には静電容量許容差記号が入ります。
□ Please specify the capacitance tolerance code.

063TYPE

Class 1

定格電圧 Rated Voltage (DC)	形名 Ordering code	EHS (Environmental Hazardous Substances)	温度特性 Temperature characteristics (EIA)																	公称静電 容 量 Capacitance [pF]	静電容量 許容差 Capacitance tolerance	厚み Thicknees [mm] (inch)
			CK (C0K)	CJ (C0J)	CH (C0H)	CG (C0G)	PK (P2K)	PJ (P2J)	PH (P2H)	RK (R2K)	RJ (R2J)	RH (R2H)	SK (S2K)	SJ (S2J)	SH (S2H)	TK (T2K)	TJ (T2J)	TH (T2H)	UK (U2K)			
25V	TMK063 △0R5□P	RoHS	●																	0.5	±0.25pF	0.3±0.03 (0.012±0.001)
	TMK063 △010□P	RoHS	●																	1		
	TMK063 △1R5□P	RoHS	●																	1.5		
	TMK063 △020□P	RoHS	●																	2		
	TMK063 △030□P	RoHS		●																3		
	TMK063 △040□P	RoHS			●															4		
	TMK063 △050□P	RoHS			●															5		
	TMK063 △060□P	RoHS			●															6		
	TMK063 △070□P	RoHS			●															7		
	TMK063 △080□P	RoHS			●															8		
	TMK063 △090□P	RoHS			●															9		
	TMK063 △100□P	RoHS			●															10		
	TMK063 △120□P	RoHS			●															12		
	TMK063 △150□P	RoHS			●															15		
	TMK063 CH180□P	RoHS			●															18		
	TMK063 CH220□P	RoHS			●															22		
	TMK063 CH270□P	RoHS			●															27		
	TMK063 CH330□P	RoHS			●															33		
	TMK063 CH390□P	RoHS			●															39		
	TMK063 CH470□P	RoHS			●															47		
TMK063 CH560□P	RoHS			●															56			
TMK063 CH680□P	RoHS			●															68			
TMK063 CH820□P	RoHS			●															82			
TMK063 CH101□P	RoHS			●															100			

注:形名の△には温度特性、□には静電容量許容差記号が入ります。
△ Please specify the temperature characteristics code and □ the capacitance tolerance code.

105TYPE

Class 1

定格電圧 Rated Voltage (DC)	形名 Ordering code	EHS (Environmental Hazardous Substances)	温度特性 Temperature characteristics (EIA)																	公称静電容量 Capacitance [pF]	静電容量許容差 Capacitance tolerance	厚み Thickness [mm] (inch)											
			CK	CJ	CH	CG	PK	PJ	PH	RK	RJ	RH	SK	SJ	SH	TK	TJ	TH	UK				UJ	SL									
			(C0K)	(C0J)	(C0H)	(C0G)	(P2K)	(P2J)	(P2H)	(P2K)	(P2J)	(P2H)	(S2K)	(S2J)	(S2H)	(T2K)	(T2J)	(T2H)	(U2K)				(U2J)										
50V	UMK105 △ 0R5□W	RoHS	●															●		0.5	±0.25pF	0.5±0.05 (0.020±0.002)											
	UMK105 △ 010□W	RoHS	●															●		1													
	UMK105 △ 1R5□W	RoHS	●															●		1.5													
	UMK105 △ 020□W	RoHS	●																●				2										
	UMK105 △ 030□W	RoHS		●															●				3										
	UMK105 △ 040□W	RoHS			●														●				4										
	UMK105 △ 050□W	RoHS				●													●				5										
	UMK105 △ 060□W	RoHS					●												●		6												
	UMK105 △ 070□W	RoHS						●											●		7												
	UMK105 △ 080□○	RoHS							●										●		8												
	UMK105 △ 090□○	RoHS								●									●		9												
	UMK105 △ 100□○	RoHS									●								●		10												
	UMK105 △ 120□○	RoHS										●							●		12												
	UMK105 △ 150□○	RoHS											●						●		15												
	UMK105 △ 180□○	RoHS												●					●		18												
	UMK105 △ 220□V	RoHS													●				●		22												
	UMK105 △ 270□V	RoHS														●			●		27												
	UMK105 △ 330□V	RoHS															●		●		33												
	UMK105 △ 390□V	RoHS																●	●		39												
	UMK105 △ 470□V	RoHS																	●	●	47												
	UMK105 △ 560□V	RoHS																		●	●		56										
	UMK105 △ 680□V	RoHS																			●		●	68									
	UMK105 △ 820□V	RoHS																					●	●	82								
	UMK105 △ 101□V	RoHS																						●	●	100							
	UMK105 △ 121□V	RoHS																							●	●	120						
	UMK105 △ 151□V	RoHS																								●	●	150					
	UMK105 △ 181□V	RoHS																									●	●	180				
	UMK105 △ 221□V	RoHS																										●	●	220			
	UMK105 △ 271□V	RoHS																											●	●	270		
	UMK105 △ 331□V	RoHS																												●	●	330	
	UMK105 SL121□V	RoHS																												●	●	120	
	UMK105 SL151□V	RoHS																													●	●	150
	UMK105 SL181□V	RoHS																													●	●	180
UMK105 SL221□V	RoHS																												●	●	220		
UMK105 SL271□V	RoHS																												●	●	270		
UMK105 SL331□V	RoHS																												●	●	330		

注:形名の△には温度特性、□には静電容量許容差記号、○にはCHの時には「V」、UJの時は「W」が入ります。
 △ Please specify the temperature characteristics code. □ Please specify the capacitance tolerance code.
 ○ comes to "V" when △ is "CH" and "W" when △ is "UJ".

105TYPE

Class 1

定格電圧 Rated Voltage (DC)	形名 Ordering code	EHS (Environmental Hazardous Substances)	温度特性 Temperature characteristics (EIA)																	公称静電容量 Capacitance [pF]	静電容量許容差 Capacitance tolerance	厚み Thickness [mm] (inch)												
			CK	CJ	CH	CG	PK	PJ	PH	RK	RJ	RH	SK	SJ	SH	TK	TJ	TH	UK				UJ	SL										
			(C0K)	(C0J)	(C0H)	(C0G)	(P2K)	(P2J)	(P2H)	(P2K)	(P2J)	(P2H)	(S2K)	(S2J)	(S2H)	(T2K)	(T2J)	(T2H)	(U2K)				(U2J)											
50V	UMK105 △ 0R5BW	RoHS												●																0.5	±0.1pF	0.5±0.05 (0.020±0.002)		
	UMK105 △ 010BW	RoHS												●																			1	
	UMK105 △ 1R2BW	RoHS												●																				1.2
	UMK105 △ 1R5BW	RoHS												●																				1.5
	UMK105 △ 1R8BW	RoHS												●																				1.8
	UMK105 △ 2R2JW	RoHS												●																				2.2
	UMK105 △ 2R7JW	RoHS												●																			2.7	
	UMK105 △ 3R3JW	RoHS													●																		3.3	
	UMK105 △ 3R9JW	RoHS														●																		3.9
	UMK105 △ 4R7JW	RoHS															●																	4.7
	UMK105 △ 5R6JW	RoHS																●																5.6
	UMK105 △ 6R8JW	RoHS																	●															6.8
	UMK105 △ 8R2JW	RoHS																		●														8.2
	UMK105 △ 100JW	RoHS																			●													10
	UMK105 △ 120JW	RoHS																				●												12
	UMK105 △ 150JW	RoHS																					●											15
	UMK105 △ 180JW	RoHS																						●										18
	UMK105 △ 200JW	RoHS																							●									20

注:形名の△には温度特性が入ります。
 △ Please specify the temperature characteristics code.

一般積層セラミックコンデンサ

(高誘電率系・Class 2)

STANDARD MULTILAYER CERAMIC CAPACITORS (CLASS2 :HIGH DIELECTRIC CONSTANT TYPE)

OPERATING TEMP.	Code	Temp.characteristics	Operating temp. range
	BJ	B	-25~+85°C
		X5R*	-55~+85°C
	B7	X7R	-55~+125°C
	F	F	-25~+85°C
Y5V		-30~+85°C	

*個別仕様の取交しにより、X7R/X7S 仕様に対応している場合があります。

*We may provide X7R/X7S for some items according to the individual specification.

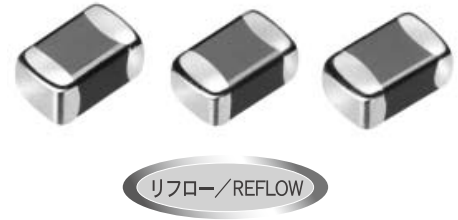

特長 FEATURES

- ・実装密度の向上が図れます
- ・モノリシックの構造のため、信頼性が高い
- ・同一形状、静電容量範囲が広い

- ・ Improve Higher Mounting Densities.
- ・ Multilayer block structure provides higher reliability
- ・ A wide range of capacitance values available in standard case sizes.

用途 APPLICATIONS

- ・ 一般電子機器用
- ・ 通信機器用 (携帯電話、PHS、コードレス電話 etc.)

- ・ General electronic equipment
- ・ Communication equipment (cellular phone, PHS, other wireless applications, etc.)

形名表記法 ORDERING CODE

1 定格電圧 (VDC)	4 形状寸法 (EIA) L×W (mm)	6 公称静電容量 (pF)	7 容量許容差	9 個別仕様
A 4 J 6.3 L 10 E 16 T 25 G 35 U 50	042(01005) 0.4×0.2 063(0201) 0.6×0.3 105(0402) 1.0×0.5	例 102 1000 223 22000	K ±10% M ±20% Z +80% -20%	- 標準
2 シリーズ名	5 温度特性	8 製品厚み (mm)	10 包装	11 当社管理記号
M 積層コンデンサ	BJ B X5R B7 X7R △F F Y5V △=スペース	C 0.2 P 0.3 V 0.5	F φ178mm テーピング (2mmピッチ)	△ 標準 △=スペース
3 端子電極				
K メッキ品				



1 Rated voltage [VDC]	4 Dimensions (case size) (L×W) (mm)	6 Nominal capacitance [pF]	7 Capacitance tolerance	9 Special code
A 4 J 6.3 L 10 E 16 T 25 G 35 U 50	042(01005) 0.4×0.2 063(0201) 0.6×0.3 105(0402) 1.0×0.5	example 102 1000 223 22000	K ±10% M ±20% Z +80% -20%	- Standard products
2 Series name	5 Temperature characteristics code	8 Thickness (mm)	10 Packaging	11 Internal code
M Multilayer ceramic capacitor	BJ B X5R B7 X7R △F F Y5V △=Blank space	C 0.2 P 0.3 V 0.5	F φ178mm Taping (2mm pitch)	△ Standard Products △=Blank space
3 End termination				
K Plated				

外形寸法 EXTERNAL DIMENSIONS

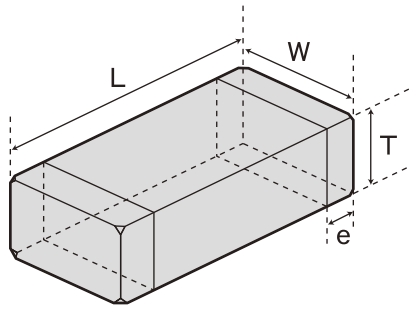

Type (EIA)	L	W	T		e
□MK042 (01005)	0.4±0.02 (0.016±0.001)	0.2±0.02 (0.008±0.001)	0.2±0.02 (0.008±0.001)	C	0.1±0.03 (0.004±0.001)
□MK063 (0201)	0.6±0.03 (0.024±0.001)	0.3±0.03 (0.012±0.001)	0.3±0.03 (0.012±0.001)	P	0.15±0.05 (0.006±0.002)
□MK105 (0402)	1.0±0.05*1 (0.039±0.002)	0.5±0.05*1 (0.020±0.002)	0.5±0.05*1 (0.020±0.002)	V	0.25±0.10 (0.010±0.004)

注: *1 ±0.1mm 公差あり
Note: *1. Including dimension tolerance±0.1mm

Unit : mm (inch)

概略バリエーション AVAILABLE CAPACITANCE RANGE

■汎用積層セラミックコンデンサ (General Multilayer Ceramic capacitors)

Cap [pF]	Type Temp.char. VDC [pF:3digits]	042				063				105																		
		B/X5R		B/X5R		X5R		B/X7R		B/X5R				X5R		F/Y5V												
		10V	6.3V	25V	16V	10V	10V	6.3V	4V	50V	25V	16V	50V	35V	25V	16V	10V	6.3V	10V	6.3V	4V	50V	25V	16V	10V	6.3V		
100	101																											
150	151																											
220	221	C																										
330	331			P																								
470	471																											
680	681																											
1000	102																											
1500	152																											
2200	222																											
3300	332																											
4700	472																											
6800	682																											
10000	103																											
15000	153																											
22000	223																											
33000	333																											
47000	473																											
68000	683																											
100000	104																											
220000	224																											
330000	334																											
470000	474																											
1000000	105																											
2200000	225																											
3300000	335																											
4700000	475																											

注: グラフの記号は製品厚み記号です。Note : Letters in the table indicate thickness.

温度特性コード Temp.char.Code	温度特性 Temperature characteristics					静電容量許容差[%] Capacitance tolerance	tanδ[%] Dissipation factor
	準拠規格 Applicable standard		温度範囲[°C] Temperature range	基準温度[°C] Ref. Temp.	静電容量変化率[%] Capacitance change		
B/BJ	JIS	B	-25~+85	20	±10	±10 (K) ±20 (M)	2.5 max.*
	EIA	X5R	-55~+85	25	±15		
B7	EIA	X7R	-55~+125	25	±15		
F	JIS	F	-25~+85	20	+30/-80	+80 (Z) -20	7.0 max.*
	EIA	Y5V	-30~+85	25	+22/-82		

*: 代表的な値を記載しています。詳細はアイテム一覧を参照ください。
*: The figure indicate typical value. Please refer to PART NUMBERS table.

セレクションガイド
Selection Guide



etc

アイテム一覧
Part Numbers



特性図
Electrical Characteristics



梱包
Packaging



信頼性
Reliability Data



使用上の注意
Precautions



■ 042TYPE(01005 case size)

【温度特性 Temp.char. BJ:B/X5R】

定格電圧 Rated Voltage	形名 Ordering code	EHS (Environmental Hazardous Substances)	公称 静電容量 Capacitance [pF]	温度特性 Temperature characteristics	tan δ Dissipation factor [%] Max.	実装条件 Soldering method R:リフロー Reflow soldering W: フロー Wave soldering	静電容量 許容差 Capacitance tolerance	厚み Thickness [mm] (inch)
10V	LMK042 BJ101 □ C	RoHS	100	B/X5R*2	5	R	± 10% ± 20%	0.2 ± 0.02 (0.008 ± 0.001)
	LMK042 BJ151 □ C	RoHS	150					
	LMK042 BJ221 □ C	RoHS	220					
	LMK042 BJ331 □ C	RoHS	330					
	LMK042 BJ471 □ C	RoHS	470					
	LMK042 BJ681 □ C	RoHS	680					
LMK042 BJ102 □ C	RoHS	1000						
6.3V	JMK042 BJ152 □ C*1	RoHS	1500		10			
	JMK042 BJ222 □ C*1	RoHS	2200					
	JMK042 BJ332 □ C*1	RoHS	3300					
	JMK042 BJ472 □ C*1	RoHS	4700					
	JMK042 BJ682 □ C*1	RoHS	6800					
	JMK042 BJ103 □ C*1	RoHS	10000					

形名の□には静電容量許容差記号が入ります。

*1 高温負荷試験の試験電圧は定格電圧の 1.5 倍

*2 個別仕様の取交しにより、X7R/X7S仕様に対応している場合があります。

□ Please specify the capacitance tolerance code.

*1 Test Voltage of Loading at high temperature test is 1.5 time of the rated voltage.

*2 We may provide X7R/X7S for some items according to the individual specification.

■ 063TYPE(0201 case size)

【温度特性 Temp.char. BJ:B/X5R】

定格電圧 Rated Voltage	形名 Ordering code	EHS (Environmental Hazardous Substances)	公称 静電容量 Capacitance [pF]	温度特性 Temperature characteristics	tan δ Dissipation factor [%] Max.	実装条件 Soldering method R:リフロー Reflow soldering W: フロー Wave soldering	静電容量 許容差 Capacitance tolerance	厚み Thickness [mm] (inch)
25V	TMK063 BJ101 □ P	RoHS	100	B/X5R*2	3.5	R	±10% ±20%	0.3±0.03 (0.012 ± 0.001)
	TMK063 BJ151 □ P	RoHS	150					
	TMK063 BJ221 □ P	RoHS	220					
	TMK063 BJ331 □ P	RoHS	330					
	TMK063 BJ471 □ P	RoHS	470					
	TMK063 BJ681 □ P	RoHS	680					
	TMK063 BJ102 □ P	RoHS	1000					
16V	EMK063 BJ152 □ P	RoHS	1500		5			
	EMK063 BJ222 □ P	RoHS	2200					
	EMK063 BJ332 □ P	RoHS	3300					
10V	LMK063 BJ472 □ P	RoHS	4700		7.5			
	LMK063 BJ682 □ P	RoHS	6800					
	LMK063 BJ103 □ P	RoHS	10000					
	LMK063 BJ223 □ P*1	RoHS	22000					
	LMK063 BJ473 □ P*1	RoHS	47000					
6.3V	LMK063 BJ104 □ P*1	RoHS	100000	10				
	JMK063 BJ473 □ P*1	RoHS	47000					
	JMK063 BJ104 □ P*1	RoHS	100000					
	JMK063 BJ224MP*1,*3	RoHS	220000					
4V	AMK063 BJ224MP*1	RoHS	220000	10				
	AMK063 BJ334MP*1,*3	RoHS	330000					
	AMK063 BJ474MP*1,*3	RoHS	470000					

形名の□には静電容量許容差記号が入ります。

*1 高温負荷試験の試験電圧は定格電圧の 1.5 倍

*2 個別仕様の取交しにより、X7R仕様に対応している場合があります。

*3 ご使用の回路や機器により、個別仕様の取り交わしが必要になります。必ず正規販売チャンネルにお問い合わせください。

□ Please specify the capacitance tolerance code.

*1 Test Voltage of Loading at high temperature test is 1.5 time of the rated voltage.

*2 We may provide X7R for some items according to the individual specification.

*3 The exchange of individual specification is necessary depending on the application and circuit condition. Please contact Taiyo Yuden sales channel.

■ 105TYPE (0402 case size)

【温度特性 Temp.char. BJ:B/X5R】

定格電圧 Rated Voltage	形名 Ordering code	EHS (Environmental Hazardous Substances)	公称 静電容量 Capacitance [pF]	温度特性 Temperature characteristics	tan δ Dissipation factor [%] Max.	実装条件 Soldering method R: リフロー - Reflow soldering W: 7ロ - Wave soldering	静電容量 許容差 Capacitance tolerance	厚み Thickness [mm] (inch)
50V	UMK105 BJ221□V	RoHS	220	B/X5R*2	2.5	R	±10% ±20%	0.5±0.05 (0.02 ± 0.002)
	UMK105 BJ331□V	RoHS	330					
	UMK105 BJ471□V	RoHS	470					
	UMK105 BJ681□V	RoHS	680					
	UMK105 BJ102□V	RoHS	1000					
	UMK105 BJ152□V	RoHS	1500					
	UMK105 BJ222□V	RoHS	2200					
	UMK105 BJ332□V	RoHS	3300					
	UMK105 BJ472□V	RoHS	4700					
35V	UMK105 BJ682□V*1	RoHS	6800	B/X5R	3.5	R	±10% ±20%	0.5±0.05 (0.02 ± 0.002)
	UMK105 BJ103□V	RoHS	10000		5			
25V	GMK105 BJ104□V*1	RoHS	100000	B/X5R*2	5	R	±10% ±20%	0.5±0.05 (0.02 ± 0.002)
	TMK105 BJ682□V	RoHS	6800		2.5			
	TMK105 BJ103□V	RoHS	10000		3.5			
	TMK105 BJ153□V	RoHS	15000					
	TMK105 BJ223□V	RoHS	22000					
	TMK105 BJ333□V*1	RoHS	33000					
16V	TMK105 BJ473□V*1	RoHS	47000	B/X5R	5	R	±10% ±20%	0.5±0.05 (0.02 ± 0.002)
	EMK105 BJ333□V	RoHS	33000		3.5			
	EMK105 BJ473□V	RoHS	47000					
	EMK105 BJ683□V	RoHS	68000		5			
	EMK105 BJ104□V*1	RoHS	100000					
EMK105 BJ224□V*1	RoHS	220000						
10V	LMK105 BJ104□V	RoHS	100000	B/X5R	10	R	±10% ±20%	0.5±0.05 (0.02 ± 0.004)
	LMK105 BJ224□V*1	RoHS	220000					
	LMK105 BJ474□V*1	RoHS	470000					
	LMK105 BJ105□V*1	RoHS	1000000					
6.3V	JMK105 BJ224□V*1	RoHS	220000	B/X5R	5	R	±10% ±20%	0.5±0.05 (0.02 ± 0.004)
	JMK105 BJ474□V*1	RoHS	470000					
	JMK105 BJ105□V*1	RoHS	1000000					
	JMK105 BJ225MV*1,*3	RoHS	2200000					
4V	AMK105 BJ335MV*1,*3	RoHS	3300000	X5R	10	R	±20%	0.5±0.1 (0.02 ± 0.004)
	AMK105 BJ475MV*1,*3	RoHS	4700000					

形名の□には静電容量許容差記号が入ります。

*1 高温負荷試験の試験電圧は定格電圧の 1.5 倍

*2 個別仕様の取交しにより、X7R仕様に対応している場合があります。

*3 ご使用の回路や機器により、個別仕様の取交しが必要になります。
必ず正規販売チャンネルにお問い合わせください。

□ Please specify the capacitance tolerance code.

*1 Test Voltage of Loading at high temperature test is 1.5 time of the rated voltage.

*2 We may provide X7R for some items according to the individual specification.

*3 The exchange of individual specification is necessary depending on the application and circuit condition. Please contact Taiyo Yuden sales channel.

【温度特性 Temp.char. B7:X7R】

定格電圧 Rated Voltage	形名 Ordering code	EHS (Environmental Hazardous Substances)	公称 静電容量 Capacitance [pF]	温度特性 Temperature characteristics	tan δ Dissipation factor [%] Max.	実装条件 Soldering method R:リフロー Reflow soldering W: フロ Wave soldering	静電容量 許容差 Capacitance tolerance	厚み Thickness [mm] (inch)
50V	UMK105 B7 221□V	RoHS	220	X7R	2.5	R	±10% ±20%	0.5±0.05 (0.02 ± 0.002)
	UMK105 B7 331□V	RoHS	330					
	UMK105 B7 471□V	RoHS	470					
	UMK105 B7 681□V	RoHS	680					
	UMK105 B7 102□V	RoHS	1000					
	UMK105 B7 152□V	RoHS	1500		3.5			
	UMK105 B7 222□V	RoHS	2200					
	UMK105 B7 332□V	RoHS	3300					
	UMK105 B7 472□V*1	RoHS	4700					
	UMK105 B7 682□V*1	RoHS	6800					
UMK105 B7 103□V*1	RoHS	10000	2.5					
TMK105 B7 472□V	RoHS	4700						
TMK105 B7 682□V	RoHS	6800						
TMK105 B7 103□V	RoHS	10000						
TMK105 B7 153□V*1	RoHS	15000						
TMK105 B7 223□V*1	RoHS	22000						
TMK105 B7 333□V*1	RoHS	33000						
TMK105 B7 473□V*1	RoHS	47000	3.5					
EMK105 B7 153□V	RoHS	15000						
EMK105 B7 223□V	RoHS	22000						
EMK105 B7 333□V	RoHS	33000						
16V	EMK105 B7 473□V	RoHS	47000	5				
	EMK105 B7 104□V*1	RoHS	100000					

形名の□には静電容量許容差記号が入ります。
*1 高温負荷試験の試験電圧は定格電圧の 1.5 倍

□ Please specify the capacitance tolerance code.
*1 Test Voltage of Loading at high temperature test is 1.5 time of the rated voltage.

【温度特性 Temp.char. F:Y5V】

定格電圧 Rated Voltage	形名 Ordering code	EHS (Environmental Hazardous Substances)	公称 静電容量 Capacitance [pF]	温度特性 Temperature characteristics	tan δ Dissipation factor [%] Max.	実装条件 Soldering method R:リフロー Reflow soldering W: フロ Wave soldering	静電容量 許容差 Capacitance tolerance	厚み Thickness [mm] (inch)
50V	UMK105 F103ZV	RoHS	10000	F/Y5V	5	R	+80% -20%	0.5±0.05 (0.02 ± 0.002)
25V	TMK105 F223ZV	RoHS	22000		7			
16V	EMK105 F473ZV	RoHS	47000		9			
	EMK105 F104ZV	RoHS	100000		11			
10V	LMK105 F224ZV	RoHS	220000		12.5			
6.3V	JMK105 F474ZV	RoHS	470000		20			
	JMK105 F105ZV*1	RoHS	1000000					

*1 高温負荷試験の試験電圧は定格電圧の 1.5 倍

*1 Test Voltage of Loading at high temperature test is 1.5 time of the rated voltage.

高周波積層セラミックコンデンサ

MULTILAYER CERAMIC CAPACITORS

FOR HIGH FREQUENCY APPLICATIONS(1GHz+)

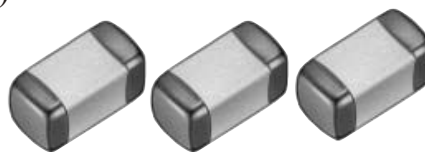

リフロー/REFLOW

OPERATING TEMP. -55~+125°C

特長 FEATURES

- 積層磁器コンデンサとしては高いQ値が高周波で得られる
- 1005形状であるため、実装密度の向上、軽量化が図れる
- Q values in the high frequency range (1 GHz+) are excellent compared to other types of multilayer capacitors.
- The 1005(0402) case size is designed for high density mounting and weight reduction in various applications.

用途 APPLICATIONS

- 高周波におけるコンデンサのQ値および小型化が求められる用途向き
VCO、TCXO etc
- 高周波回路の特性調整用途
- Suitable for those high frequency applications in which a capacitor with both a high Q-value and small size is required such as portable communications and other wireless applications.
VCO, TCXO, etc.
- Adjustment of characteristics in high frequency circuit

形名表記法 ORDERING CODE

1 定格電圧 [VDC]	4 形状寸法 (EIA) L×W [mm]	6 公称静電容量 [pF]	8 製品厚み [mm]	10 包装
E 16 U 50	105(0402) 1.0×0.5	例 020 2 4R3 4.3	W 0.5	F φ178mm テーピング (2mmピッチ)
2 シリーズ名	5 温度特性 [ppm/°C]	7 容量許容差	9 個別仕様	
V 高周波用積層コンデンサ	CH 0±60 RH -220±60	B ±0.1pF J ±5%	- 標準	
3 端子電極				
K メッキ品				

※R=小数点

U V K 1 0 5 R H 4 R 3 J W - F

1 2 3 4 5 6 7 8 9 10

1 Rated voltage [VDC]	4 Dimensions (case size) (L×W) [mm]	6 Nominal capacitance [pF]	8 Thickness [mm]	10 Packaging
E 16 U 50	105(0402) 1.0×0.5	example 020 2 4R3 4.3	W 0.5	F φ178mm Taping (2mm pitch)
2 Series name	5 Temperature characteristics [ppm/°C]	7 Capacitance tolerance	9 Special code	
V MULTILAYER CERAMIC CAPACITORS FOR HIGH FREQUENCY	CH 0±60 RH -220±60	B ±0.1pF J ±5%	- Standard Products	
3 End termination				
K Plated				

※R=Decimal point

外形寸法 EXTERNAL DIMENSIONS

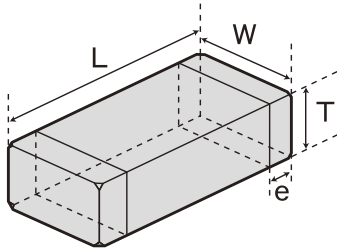

Type(EIA)	L	W	T	e
□VK105 (0402)	1.0±0.05 (0.039±0.002)	0.5±0.05 (0.020±0.002)	0.5±0.05 (0.020±0.002)	0.25±0.1 (0.010±0.004)

Unit : mm (inch)

アイテム一覧 PART NUMBERS

定格電圧 Rated Voltage (DC)	形名 Ordering code	EHS (Environmental Hazardous Substances)	温度特性 Temperature characteristics		公称 静電容量 Capacitance [pF]	静電容量 許容差 Capacitance tolerance	Q規格値 (at 1GHz) Q (min)	厚み Thickness [mm]	Q typ.値 (参考値) Typical Q
			CH	RH					
E: 16V U: 50V	<input type="checkbox"/> VK105 CH0R3BW	RoHS	●		0.3	±0.1pF	300	0.5±0.05	1200
	<input type="checkbox"/> VK105 CH0R4BW	RoHS	●		0.4		300		1200
	<input type="checkbox"/> VK105 CH0R5BW	RoHS	●		0.5		300		1200
	<input type="checkbox"/> VK105 CH0R6BW	RoHS	●		0.6		300		1100
	<input type="checkbox"/> VK105 CH0R7BW	RoHS	●		0.7		300		1100
	<input type="checkbox"/> VK105 CH0R8BW	RoHS	●		0.8		300		1000
	<input type="checkbox"/> VK105 CH0R9BW	RoHS	●		0.9		300		950
	<input type="checkbox"/> VK105 CH010BW	RoHS	●		1.0		300		950
	<input type="checkbox"/> VK105 CH1R1BW	RoHS	●		1.1		280		930
	<input type="checkbox"/> VK105 CH1R2BW	RoHS	●		1.2		270		850
	<input type="checkbox"/> VK105 CH1R3BW	RoHS	●		1.3	260	740		
	<input type="checkbox"/> VK105 CH1R5BW	RoHS	●		1.5	240	710		
	<input type="checkbox"/> VK105 CH1R6BW	RoHS	●		1.6	230	670		
	<input type="checkbox"/> VK105 CH1R8BW	RoHS	●		1.8	210	650		
	<input type="checkbox"/> VK105 CH020BW	RoHS	●		2.0	190	610		
	<input type="checkbox"/> VK105 CH2R2JW	RoHS	●		2.2	180	530		
	<input type="checkbox"/> VK105 CH2R4JW	RoHS	●		2.4	170	510		
	<input type="checkbox"/> VK105 CH2R7JW	RoHS	●		2.7	150	460		
	<input type="checkbox"/> VK105 CH030JW	RoHS	●		3.0	130	390		
	<input type="checkbox"/> VK105 CH3R3JW	RoHS	●		3.3	120	370		
	<input type="checkbox"/> VK105 CH3R6JW	RoHS	●		3.6	110	360		
	<input type="checkbox"/> VK105 CH3R9JW	RoHS	●		3.9	99	360		
	<input type="checkbox"/> VK105 CH4R3JW	RoHS	●		4.3	84	360		
	<input type="checkbox"/> VK105 CH4R7JW	RoHS	●		4.7	84	340		
	<input type="checkbox"/> VK105 CH5R1JW	RoHS	●		5.1	84	320		
	<input type="checkbox"/> VK105 RH0R5BW	RoHS		●	0.5	300	1100		
	<input type="checkbox"/> VK105 RH0R6BW	RoHS		●	0.6	300	1000		
	<input type="checkbox"/> VK105 RH0R7BW	RoHS		●	0.7	300	1000		
	<input type="checkbox"/> VK105 RH0R8BW	RoHS		●	0.8	300	970		
	<input type="checkbox"/> VK105 RH0R9BW	RoHS		●	0.9	300	950		
	<input type="checkbox"/> VK105 RH010BW	RoHS		●	1.0	300	900		
	<input type="checkbox"/> VK105 RH1R1BW	RoHS		●	1.1	280	900		
	<input type="checkbox"/> VK105 RH1R2BW	RoHS		●	1.2	270	740		
	<input type="checkbox"/> VK105 RH1R3BW	RoHS		●	1.3	260	700		
	<input type="checkbox"/> VK105 RH1R5BW	RoHS		●	1.5	240	680		
	<input type="checkbox"/> VK105 RH1R6BW	RoHS		●	1.6	230	640		
	<input type="checkbox"/> VK105 RH1R8BW	RoHS		●	1.8	210	620		
	<input type="checkbox"/> VK105 RH020BW	RoHS		●	2.0	190	570		
	<input type="checkbox"/> VK105 RH2R2JW	RoHS		●	2.2	180	480		
	<input type="checkbox"/> VK105 RH2R4JW	RoHS		●	2.4	170	470		
<input type="checkbox"/> VK105 RH2R7JW	RoHS		●	2.7	150	420			
<input type="checkbox"/> VK105 RH030JW	RoHS		●	3.0	130	360			
<input type="checkbox"/> VK105 RH3R3JW	RoHS		●	3.3	120	350			
<input type="checkbox"/> VK105 RH3R6JW	RoHS		●	3.6	110	340			
<input type="checkbox"/> VK105 RH3R9JW	RoHS		●	3.9	99	340			
<input type="checkbox"/> VK105 RH4R3JW	RoHS		●	4.3	84	340			
<input type="checkbox"/> VK105 RH4R7JW	RoHS		●	4.7	84	320			
<input type="checkbox"/> VK105 RH5R1JW	RoHS		●	5.1	84	310			

注：□には定格電圧記号がはいります。 □Please specify the Rated Voltage code.

仕様 SPECIFICATIONS

温度特性 Temperature Characteristics	使用温度範囲 Operating Temperature range	温度係数範囲 Temperature Coefficient range [ppm/°C]	静電容量許容差 Capacitance Tolerance (区分)
CH	-55~+125°C	0±60	±0.1pF (~2.0pF)
RH		-220±60	±5% (2.2pF~)

■容量値とQの関係例 (CH特性例) Capacitance vs Q value (Typical for CH T.C.)

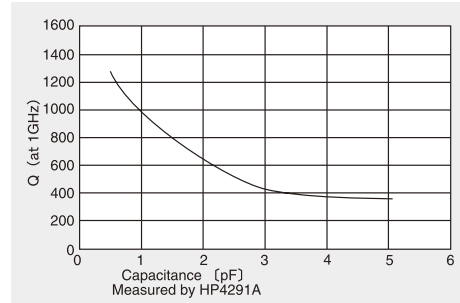

セレクションガイド
Selection Guide

アイテム一覧
Part Numbers

特性図
Electrical Characteristics

梱包
Packaging

信頼性
Reliability Data

使用上の注意
Precautions



etc

超低歪積層セラミックコンデンサ (CFCAP™)

SUPER LOW DISTORTION MULTILAYER CERAMIC CAPACITORS (CFCAP™)

OPERATING TEMP. -55~+125°C



リフロー/REFLOW

特長 FEATURES

- ・新規開発を行った誘電体材料を使用し優れた温度特性と内部電極にNiを用いることで、小型・高容量・低コストを実現しました
- ・低歪み率、低ショックノイズでアナログ回路や携帯機器のデジタル回路に最適です
- ・耐熱性、耐破壊電圧、機械的強度が高くフィルムコンデンサの置き換えに最適です

- ・ Newly developed dielectric material and the use of nickel for internal electrodes provide excellent temperature characteristics with high capacitance, small case size and low cost.
- ・ Low distortion and low shock noise make these capacitors well suited for use in analog or digital mobile devices.
- ・ Excellent heat-resistance, high break down voltage, and mechanical strength make these capacitors well suited for replacing film capacitors.

用途 APPLICATIONS

- ・ AV関連機器などの信号回路
- ・ アナログ信号のカップリング用途
- ・ 携帯電話のPLL回路
- ・ 良好な温度特性による時定数回路、発信回路、フィルタなど

- ・ Signal line for AV products
- ・ Analog signal coupling applications
- ・ PLL circuit of mobile phones
- ・ Good temperature characteristics for time constant circuits, oscillation circuits and filters

形名表記法 ORDERING CODE

1 定格電圧 (VDC)	3 端子電極	5 シリーズ記号	7 容量許容差	9 個別仕様
U 50 G 35 T 25 E 16 L 10	K メッキ品	SD スタンダード	K ±10%	- 標準
2 シリーズ名	4 形状寸法 (EIA) L×W (mm)	6 公称静電容量 (μF)	8 製品厚み (mm)	10 包装
M 積層コンデンサ	105 (0402) 1.0×0.5 107 (0603) 1.6×0.8 212 (0805) 2.0×1.25 316 (1206) 3.2×1.6	例 223 0.022 104 0.1	V 0.5 A 0.8 D 0.85 F 1.15 G 1.25 L 1.6	T φ178mm テーピング (4mmピッチ) 107, 212, 316形状 F φ178mm テーピング (2mmピッチ) 105形状
				11 当社管理記号
				△ 標準品 △=スペース

T M K 3 1 6 S D 1 0 4 K L - T △

1 Rated voltage [VDC]	3 End termination	5 Series symbol	7 Capacitance tolerance	9 Special code
U 50 G 35 T 25 E 16 L 10	K Plated	SD Standard	K ±10%	- Standard products
2 Series name	4 Dimensions (case size) (mm)	6 Nominal capacitance (μF)	8 Thickness (mm)	10 Packaging
M Multilayer ceramic capacitors	105 (0402) 1.0×0.5 107 (0603) 1.6×0.8 212 (0805) 2.0×1.25 316 (1206) 3.2×1.6	example 223 0.022 104 0.1	V 0.5 A 0.8 D 0.85 F 1.15 G 1.25 L 1.6	T φ178mm Taping (4mm pitch) 0603, 0805, 1206Type F φ178mm Taping (2mm pitch) 0402Type
				11 Internal code
				△ Standard products △=Blank space

外形寸法 EXTERNAL DIMENSIONS

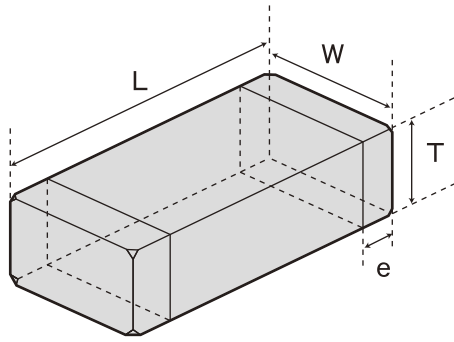

Type (EIA)	L	W	T		e
□MK105 (0402)	1.0±0.05 (0.039±0.002)	0.5±0.05 (0.020±0.002)	0.5±0.05 (0.020±0.002)	V	0.25±0.10 (0.010±0.004)
□MK107 (0603)	1.6±0.10 (0.063±0.004)	0.8±0.10 (0.031±0.004)	0.8±0.10 (0.031±0.004)	A	0.35±0.25 (0.014±0.010)
□MK212 (0805)	2.0±0.10 (0.079±0.004)	1.25±0.10 (0.049±0.004)	0.85±0.10 (0.033±0.004)	D	0.5±0.25 (0.020±0.010)
			1.25±0.10 (0.049±0.004)	G	
□MK316 (1206)	3.2±0.15 (0.126±0.006)	1.6±0.15 (0.063±0.006)	1.15±0.10 (0.045±0.004)	F	0.5 ^{+0.35} _{-0.25} (0.020 ^{+0.014} _{-0.010})
			1.6±0.20 (0.063±0.008)	L	

Unit : mm (inch)

概略バリエーション AVAILABLE CAPACITANCE RANGE

Cap [μF]	Type	105				107				212				316	
	Temp.Char	SD				SD				SD				SD	
	VDC	50V	25V	16V	10V	50V	25V	16V	10V	50V	35V	16V	10V	35V	25V
0.00039	391	V													
0.00047	471	V													
0.00056	561	V													
0.00068	681		V												
0.00082	821		V												
0.001	102		V			A									
0.0012	122		V			A									
0.0015	152			V		A									
0.0018	182			V		A									
0.0022	222			V		A									
0.0027	272			V		A									
0.0033	332				V	A									
0.0039	392				V		A			D					
0.0047	472				V		A			D					
0.0056	562						A			D					
0.0068	682						A			D					
0.0082	822						A			D					
0.01	103						A			D					
0.012	123								A		D				
0.015	153								A		D				
0.018	183								A		G				
0.022	223								A		G				
0.027	273										G				
0.033	333											D		F	
0.039	393													F	
0.047	473														F
0.056	563														F
0.068	683													G	F
0.082	823													G	L
0.1	104													G	L

※グラフ記号は製品厚みを表します。 Letters in the table indicate thickness.

シリーズコード Series Code	静電容量許容差 [%] Capacitance tolerance	tan δ [%] Dissipation factor
SD	±10 (K)	0.1max.

セレクションガイド
Selection Guide

アイテム一覧
Part Numbers

特性図
Electrical Characteristics

梱包
Packaging

信頼性
Reliability Data

使用上の注意
Precautions



アイテム一覧 PART NUMBERS

■105TYPE (0402 case size)

定格電圧 Rated Voltage	形名 Ordering code	EHS (Environmental Hazardous Substances)	公称 静電容量 Capacitance [μF]	温度特性 Temperature characteristics Standard type	tan δ Dissipation factor [%] Max.	実装条件 Soldering method R:リフロー Reflow soldering W: フロ- Wave soldering	静電容量 許容差 Capacitance tolerance	厚み Thickness [mm] (inch)
50V	UMK105 SD391KV	RoHS	0.00039	Standard type	0.1	R	±10%*	0.5±0.05 (0.020±0.002)
	UMK105 SD471KV	RoHS	0.00047					
	UMK105 SD561KV	RoHS	0.00056					
25V	TMK105 SD681KV	RoHS	0.00068					
	TMK105 SD821KV	RoHS	0.00082					
	TMK105 SD102KV	RoHS	0.0010					
16V	TMK105 SD122KV	RoHS	0.0012					
	EMK105 SD152KV	RoHS	0.0015					
	EMK105 SD182KV	RoHS	0.0018					
	EMK105 SD222KV	RoHS	0.0022					
10V	EMK105 SD272KV	RoHS	0.0027					
	LMK105 SD332KV	RoHS	0.0033					
	LMK105 SD392KV	RoHS	0.0039					
	LMK105 SD472KV	RoHS	0.0047					

*: J公差(±5%)も対応致します。御相談ください。

*: The product with "J" tolerance of ±5% is also available. Please contact our local sales.

■107TYPE (0603 case size)

定格電圧 Rated Voltage	形名 Ordering code	EHS (Environmental Hazardous Substances)	公称 静電容量 Capacitance [μF]	温度特性 Temperature characteristics Standard type	tan δ Dissipation factor [%] Max.	実装条件 Soldering method R:リフロー Reflow soldering W: フロ- Wave soldering	静電容量 許容差 Capacitance tolerance	厚み Thickness [mm] (inch)
50V	UMK107 SD102KA	RoHS	0.0010	Standard type	0.1	R	±10%*	0.8±0.1 (0.031±0.004)
	UMK107 SD122KA	RoHS	0.0012					
	UMK107 SD152KA	RoHS	0.0015					
	UMK107 SD182KA	RoHS	0.0018					
	UMK107 SD222KA	RoHS	0.0022					
	UMK107 SD272KA	RoHS	0.0027					
25V	UMK107 SD332KA	RoHS	0.0033					
	TMK107 SD392KA	RoHS	0.0039					
	TMK107 SD472KA	RoHS	0.0047					
16V	EMK107 SD562KA	RoHS	0.0056					
	EMK107 SD682KA	RoHS	0.0068					
	EMK107 SD822KA	RoHS	0.0082					
	EMK107 SD103KA	RoHS	0.010					
10V	LMK107 SD123KA	RoHS	0.012					
	LMK107 SD153KA	RoHS	0.015					
	LMK107 SD183KA	RoHS	0.018					
	LMK107 SD223KA	RoHS	0.022					

*: J公差(±5%)も対応致します。御相談ください。

*: The product with "J" tolerance of ±5% is also available. Please contact our local sales.

■212TYPE (0805 case size)

定格電圧 Rated Voltage	形名 Ordering code	EHS (Environmental Hazardous Substances)	公称 静電容量 Capacitance [μF]	温度特性 Temperature characteristics Standard type	tan δ Dissipation factor [%] Max.	実装条件 Soldering method R:リフロー Reflow soldering W: フロ- Wave soldering	静電容量 許容差 Capacitance tolerance	厚み Thickness [mm] (inch)
50V	UMK212 SD392KD	RoHS	0.0039	Standard type	0.1	R	±10%*	0.85±0.1 (0.033±0.004)
	UMK212 SD472KD	RoHS	0.0047					
	UMK212 SD562KD	RoHS	0.0056					
	UMK212 SD682KD	RoHS	0.0068					
	UMK212 SD822KD	RoHS	0.0082					
	UMK212 SD103KD	RoHS	0.01					
35V	GMK212 SD123KD	RoHS	0.012					
	GMK212 SD153KD	RoHS	0.015					
	GMK212 SD183KG	RoHS	0.018					
	GMK212 SD223KG	RoHS	0.022					
	GMK212 SD273KG	RoHS	0.027					
16V	EMK212 SD333KD	RoHS	0.033					
	LMK212 SD473KD	RoHS	0.047					
10V	LMK212 SD683KG	RoHS	0.068					
	LMK212 SD823KG	RoHS	0.082					
	LMK212 SD104KG	RoHS	0.1					

*: J公差(±5%)も対応致します。御相談ください。

*: The product with "J" tolerance of ±5% is also available. Please contact our local sales.

■316TYPE (1206 case size)

定格電圧 Rated Voltage	形名 Ordering code	EHS (Environmental Hazardous Substances)	公称 静電容量 Capacitance [μF]	温度特性 Temperature characteristics Standard type	tan δ Dissipation factor [%] Max.	実装条件 Soldering method R:リフロー Reflow soldering W: フロ- Wave soldering	静電容量 許容差 Capacitance tolerance	厚み Thickness [mm] (inch)
35V	GMK316 SD333KF	RoHS	0.033	Standard type	0.1	R	±10%*	1.15±0.1 (0.045±0.004)
	GMK316 SD393KF	RoHS	0.039					
25V	TMK316 SD473KF	RoHS	0.047					
	TMK316 SD563KF	RoHS	0.056					
	TMK316 SD683KF	RoHS	0.068					
	TMK316 SD823KL	RoHS	0.082					
	TMK316 SD104KL	RoHS	0.1					

*: J公差(±5%)も対応致します。御相談ください。

*: The product with "J" tolerance of ±5% is also available. Please contact our local sales.

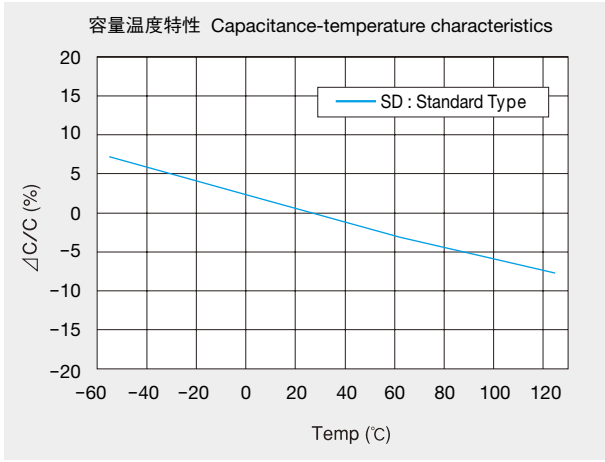

Super Low Distortion Multilayer Ceramic Capacitors (CFCAP)

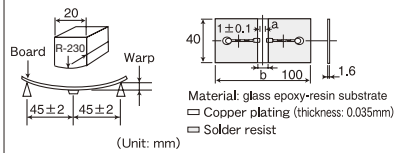
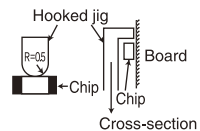
Item	Specified Value	Test Methods and Remarks
1. Operating Temperature Range	-55 to +125°C	
2. Storage Temperature Range	-55 to +125°C	
3. Rated Voltage	10VDC, 16VDC, 25VDC, 35VDC, 50VDC,	
4. Withstanding Voltage Between terminals	No breakdown or damage	Applied voltage: Rated voltage × 3 Duration: 1 to 5 sec. Charge/discharge current: 50mA max.
5. Insulation Resistance	10000 MΩ or 500MΩ μF, whichever is smaller	Applied voltage: Rated voltage Duration: 60±5 sec. Charge/discharge current: 50mA max.
6. Capacitance (Tolerance)	±10%	Measuring frequency : 1 k Hz ± 10% Measuring voltage : 1 ± 0.2Vrms Bias application: None
7. Tangent of Loss Angle (tan δ)	0.1% max	Measuring frequency : 1 k Hz ± 10% Measuring voltage : 1 ± 0.2Vrms Bias application: None
8. Resistance to Flexure of Substrate	Appearance: No abnormality Capacitance change: ±5%	Warp: 1mm Speed: 0.5mm/second Duration: 10 seconds The measurement shall be made with the board in the bent position.  (Unit: mm)
9. Body strength		
10. Adhesion of electrode	No separation or indication of separation of electrode.	Applied force: 5N Duration: 30 ± 5 seconds 
11. Solderability	At least 95% of terminal electrode is covered by new solder.	Solder temp.: 230 ± 5°C Duration: 4 ± 1 seconds
12. Resistance to soldering	Appearance: No abnormality Capacitance change: ±2.5% max. tan δ : Initial value Insulation resistance: Initial value Withstanding voltage (between terminals): No abnormality	Solder temp.: 270 ± 5°C Duration: 3 ± 0.5 seconds Preheating conditions: 80 to 100°C, 2 to 5 min. or 5 to 10 min. 150 to 200°C, 2 to 5 min. or 5 to 10 min. Recovery: Recovery for the following period under the standard condition after the test: 24 ± 2hrs
13. Thermal shock	Appearance: No abnormality Capacitance change: ±2.5% max tan δ : Initial value Insulation resistance: Initial value Withstanding voltage (between terminals): No abnormality	Conditions for 1 cycle: Step 1: Minimum operating temperature $+0$ to -3 °C 30 ± 3 minutes Step 2: Room temperature 2 to 3min. Step 3: Maximum operating temperature -0 to $+3$ °C 30 ± 3 minutes Step 4: Room temperature 2 to 3min. Number of cycles: 5 times Recovery after the test: 24 ± 2hrs
14. Damp heat (steady state)	Appearance: No abnormality Capacitance change: ±5% max tan δ : 0.5% max Insulation resistance 50MΩ μF or 1000MΩ whichever is smaller	Temperature: 40 ± 2°C Humidity: 90 to 95% RH Duration: 500 $+24$ -0 hrs Recovery: Recovery for the following period under the standard condition after the removal from test chamber: 24 ± 2hrs

Super Low Distortion Multilayer Ceramic Capacitors (CFCAP)

Item	Specified Value	Test Methods and Remarks
15.Loading under Damp Heat	Appearance: No abnormality Capacitance change: $\pm 7.5\%$ max $\tan \delta$: 0.5% max Insulation resistance: 25M Ω μ F or 500M Ω whichever is smaller	According to JIS C 5102 clause 9.9. Temperature: $40 \pm 2^\circ\text{C}$ Humidity: 90 to 95% RH Duration: 500^{+24}_{-0} hrs Applied voltage: Rated voltage Charge/discharge current: 50mA max Recovery: Recovery for the following period under the standard condition after the removal from test chamber: 24 ± 2 hrs
16.Loading at High Temperature	Appearance: No abnormality Capacitance change: $\pm 3\%$ max $\tan \delta$: 0.35% max Insulation resistance: 50M Ω μ F or 1000M Ω whichever is smaller	According to JIS C 5102 clause 9.9. Temperature: $125 \pm 3^\circ\text{C}$ Duration: 1000^{+48}_{-0} hrs Applied voltage: Rated voltage x 2 Recovery: Recovery for the following period under the standard condition after the removal from test chamber: 24 ± 2 hrs

Note on standard condition: "standard condition" referred to herein is defined as follows.

Temperature: 5 to 35°C, Relative humidity: 45 to 85 %, Air pressure: 86 to 106kpa,

When there are questions concerning measurement results: In order to provide correlation data, the test shall be conducted under condition.

Temperature: $20 \pm 2^\circ\text{C}$, Relative humidity: 60 to 70 %, Air pressure: 86 to 106kpa

Unless otherwise specified, all the tests are conducted under the "standard condition."

中高耐圧積層セラミックコンデンサ

MEDIUM-HIGH VOLTAGE MULTILAYER CERAMIC CAPACITOR

	Code	Temp.characteristics	Operating temp. range
OPERATING TEMP.	BJ	B	-25~+85°C
		X5R*	-55~+85°C
	B7	X7R	-55~+125°C
	C7	X7S	-55~+125°C

*個別仕様の取交しにより、X7R/X7S仕様に対応している場合があります。

*We may provide X7R/X7S for some items according to the individual specification.

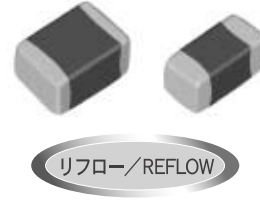

特長 FEATURES

- ・内部電極にNi金属を使用しており、マイグレーションが発生せず、高信頼性を示す。
- ・高定格電圧でありながら小型形状

- ・ The use of Nickel(Ni) as material for internal electrodes almost completely eliminates migration and high reliability
- ・ Small case sizes with high rated voltage

用途 APPLICATIONS

- ・ 一般電話交換機
- ・ インバータ
- ・ 無線、通信基地局
- ・ DC/DCコンバータ用

- ・ General telephone exchange
- ・ Inverter.
- ・ Wireless and Telecommunication base.
- ・ For DC/DC Converter

形名表記法 ORDERING CODE

1 定格電圧 (VDC)	3 端子電極	5 温度特性	7 容量許容差	9 個別仕様
H 100 Q 250 S 630	K メッキ品	BJ B X5R B7 X7R C7 X7S	K ±10% M ±20%	- 標準
2 シリーズ名	4 形状寸法 (EIA) L×W (mm)	6 公称静電容量 (pF)	8 製品厚み (mm)	10 包装
M 積層コンデンサ	107 (0603) 1.6×0.8 212 (0805) 2.0×1.25 316 (1206) 3.2×1.6 325 (1210) 3.2×2.5 432 (1812) 4.5×3.2	例 104 100,000 105 1,000,000	A 0.8 D 0.85 G 1.25 F 1.15 L 1.6 N 1.9 M 2.5	T φ178mm テーピング (4mmピッチ)
				11 当社管理記号
				△ 標準品 △=スペース

H M K | 3 1 6 | B J 1 0 4 | K L | - T △

1 2 3 | 4 | 5 | 6 | 7 8 | 9 | 10 | 11

1 Rated voltage (VDC)	3 End termination	5 Temperature characteristics code	7 Capacitance tolerance	9 Special code
H 100 Q 250 S 630	K Plated	BJ B X5R B7 X7R C7 X7S	K ±10% M ±20%	- Standard products
2 Series name	4 Dimensions(case size) (mm)	6 Nominal capacitance (pF)	8 Thickness (mm)	10 Packaging
M Multilayer ceramic capacitors	107 (0603) 1.6×0.8 212 (0805) 2.0×1.25 316 (1206) 3.2×1.6 325 (1210) 3.2×2.5 432 (1812) 4.5×3.2	example 104 100,000 105 1,000,000	A 0.8 D 0.85 G 1.25 F 1.15 L 1.6 N 1.9 M 2.5	T φ178mm Taping (4mm pitch)
				11 Internal code
				△ Standard products △=Blank space

外形寸法 EXTERNAL DIMENSIONS

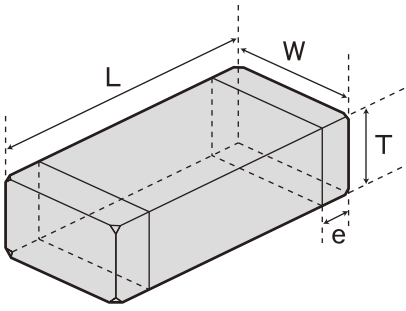

Type (EIA)	L	W	T	e	
□MK107 (0603)	1.6±0.10 (0.063±0.004)	0.8±0.10 (0.031±0.004)	0.8±0.10 (0.031±0.004)	A	0.35±0.25 (0.014±0.010)
□MK212 (0805)	2.0±0.10 (0.079±0.004)	1.25±0.10 (0.049±0.004)	0.85±0.10 (0.033±0.004)	D	0.5±0.25 (0.020±0.010)
			1.25±0.10 (0.049±0.004)	G	
□MK316 (1206)	3.2±0.15 (0.126±0.006)	1.6±0.15 (0.063±0.006)	1.15±0.10 (0.045±0.004)	F	0.5 ^{+0.35} _{-0.25} (0.020 ^{+0.014} _{-0.010})
			1.6±0.20 (0.063±0.008)	L	
□MK325 (1210)	3.2±0.3 (0.126±0.012)	2.5±0.20 (0.098±0.008)	1.15±0.10 (0.045±0.004)	F	0.6±0.3 (0.024±0.012)
			1.9±0.20 (0.075±0.008)	N	
□MK432 (1812)	4.5±0.4 (0.177±0.016)	3.2±0.30 (0.126±0.012)	2.5±0.20 (0.098±0.008)	M	0.9±0.6 (0.035±0.024)

Unit : mm (inch)

概略バリエーション AVAILABLE CAPACITANCE RANGE

Cap [μF]	Type	107			212		316			325			432		
	Temp. Char	X7R	X7S	B/X5R	X7R	B/X5R	X7R	B/X5R	X7R	B/X5R	X7R	B/X5R	X7R	B/X5R	
	VDC	100V	100V	100V	100V	250V	100V	250V	630V	100V	250V	630V	100V	250V	630V
0.001	102	A	A	D	D			F	F						
0.0015	152	A	A	D	D			F	F						
0.0022	222	A	A	D	D			F	F						
0.0033	332	A	A	D	D			F	F						
0.0047	472	A	A	G	G			F	F						
0.0068	682	A	A	G	G			F	F						
0.01	103	A	A	G	G	G	G	F	F						
0.015	153	A	A	G	G	G	G	L	L						
0.022	223	A	A	G	G	G	G	L	L		N		N		
0.033	333	A	A	G	G			L	L		N		N		
0.047	473			G	G			L	L		N	N		M	
0.068	683			G	G			L	L					M	
0.1	104		A	A	G	G		L	L		F	N		M	
0.15	154							L	L		N		N		
0.22	224			G	G			L	L		N	N		M	
0.33	334							L	L					M	
0.47	474							L	L		N		N	M	
0.68	684										N		N	M	
1.0	105							L	L		N		N	M	
1.5	155													M	
2.2	225										N		N	M	

※グラフ記号は製品厚みを表します。Letters in the table indicate thickness.

温度特性コード Temp.char.Code	温度特性 Temperature characteristics					静電容量許容差[%] Capacitance tolerance	tan δ[%] Dissipation factor
	準拠規格 Applicable standard	温度範囲[°C] Temperature range	基準温度[°C] Ref. Temp.	静電容量変化率[%] Capacitance change			
BJ	JIS	B	-25~+85	20	±10	±10 (K) ±20 (M)	2.5 max.*
	EIA	X5R	-55~+85	25	±15		
B7	EIA	X7R	-55~+125	25	±15		
C7	EIA	X7S	-55~+125	25	±22		

* : 代表的な値を記載しています。詳細はアイテム一覧表を参照ください。

* : The figure indicates typical value. Please refer to PART NUMBERS table.

セレクションガイド
Selection Guide

アイテム一覧
Part Numbers

特性図
Electrical Characteristics

梱包
Packaging

信頼性
Reliability Data

使用上の注意
Precautions



etc

■ 107TYPE(0603 case size)

【温度特性 Temp.char. BJ:B/X5R】

定格電圧 Rated Voltage	形名 Ordering code	EHS (Environmental Hazardous Substances)	公称 静電容量 Capacitance [μF]	温度特性 Temperature characteristics	tan δ Dissipation factor [%] Max.	実装条件 Soldering method R:リフロー Reflow soldering W: フロー Wave soldering	静電容量 許容差 Capacitance tolerance	厚み Thickness [mm] (inch)
100V	HMK107 BJ102□A	RoHS	0.001	B/X5R*2	3.5	R	±10% ±20%	0.8±0.1 (0.031±0.0041)
	HMK107 BJ152□A	RoHS	0.0015					
	HMK107 BJ222□A	RoHS	0.0022					
	HMK107 BJ332□A	RoHS	0.0033					
	HMK107 BJ472□A	RoHS	0.0047					
	HMK107 BJ682□A	RoHS	0.0068					
	HMK107 BJ103□A	RoHS	0.01					
	HMK107 BJ153□A	RoHS	0.015					
	HMK107 BJ223□A	RoHS	0.022					
	HMK107 BJ333□A	RoHS	0.033					
HMK107 BJ104□A	RoHS	0.1						

形名の□には静電容量許容差記号が入ります。

Please specify the capacitance tolerance code.

*2 個別仕様の取直しにより、X7R/X7S仕様に対応している場合があります。

*2 We may provide X7R/X7S for some items according to the individual specification.

【温度特性 Temp.char. B7:X7R C7:X7S】

定格電圧 Rated Voltage	形名 Ordering code	EHS (Environmental Hazardous Substances)	公称 静電容量 Capacitance [μF]	温度特性 Temperature characteristics	tan δ Dissipation factor [%] Max.	実装条件 Soldering method R:リフロー Reflow soldering W: フロー Wave soldering	静電容量 許容差 Capacitance tolerance	厚み Thickness [mm] (inch)
100V	HMK107 B7 102□A	RoHS	0.001	X7R	3.5	R	±10% ±20%	0.8±0.1 (0.031±0.0041)
	HMK107 B7 152□A	RoHS	0.0015					
	HMK107 B7 222□A	RoHS	0.0022					
	HMK107 B7 332□A	RoHS	0.0033					
	HMK107 B7 472□A	RoHS	0.0047					
	HMK107 B7 682□A	RoHS	0.0068					
	HMK107 B7 103□A	RoHS	0.01					
	HMK107 B7 153□A	RoHS	0.015					
	HMK107 B7 223□A	RoHS	0.022					
	HMK107 B7 333□A	RoHS	0.033					
	HMK107 C7 104□A	RoHS	0.1	X7S				

形名の□には静電容量許容差記号が入ります。

Please specify the capacitance tolerance code.

■ 212TYPE (0805 case size)

【温度特性 Temp.char. BJ:B/X5R】

定格電圧 Rated Voltage	形名 Ordering code	EHS (Environmental Hazardous Substances)	公称 静電容量 Capacitance 〔μF〕	温度特性 Temperature characteristics	tan δ Dissipation factor 〔%〕 Max.	実装条件 Soldering method R: リフロー- Reflow soldering W: 7口- Wave soldering	静電容量 許容差 Capacitance tolerance	厚み Thickness 〔mm〕 〔inch〕
100V	HMK212 BJ103□G	RoHS	0.01	B/X5R*2	3.5	R	±10% ±20%	1.25±0.1 (0.049±0.004)
	HMK212 BJ153□G	RoHS	0.015					
	HMK212 BJ223□G	RoHS	0.022					
	HMK212 BJ333□G	RoHS	0.033					
	HMK212 BJ473□G	RoHS	0.047					
	HMK212 BJ683□G	RoHS	0.068					
	HMK212 BJ104□G	RoHS	0.1					
HMK212 BJ224□G	RoHS	0.22						
250V	QMK212 BJ102□D	RoHS	0.001		2.5			0.85±0.1 (0.033±0.004)
	QMK212 BJ152□D	RoHS	0.0015					
	QMK212 BJ222□D	RoHS	0.0022					
	QMK212 BJ332□D	RoHS	0.0033					
	QMK212 BJ472□G	RoHS	0.0047					
	QMK212 BJ682□G	RoHS	0.0068					
	QMK212 BJ103□G	RoHS	0.01					
	QMK212 BJ153□G	RoHS	0.015					
	QMK212 BJ223□G	RoHS	0.022	1.25±0.1 (0.049±0.004)				

形名の□には静電容量許容差記号が入ります。

Please specify the capacitance tolerance code.

*2 個別仕様の取交しにより、X7R仕様に対応している場合があります。

*2 We may provide X7R for some items according to the individual specification.

【温度特性 Temp.char. B7:X7R】

定格電圧 Rated Voltage	形名 Ordering code	EHS (Environmental Hazardous Substances)	公称 静電容量 Capacitance 〔μF〕	温度特性 Temperature characteristics	tan δ Dissipation factor 〔%〕 Max.	実装条件 Soldering method R: リフロー- Reflow soldering W: 7口- Wave soldering	静電容量 許容差 Capacitance tolerance	厚み Thickness 〔mm〕 〔inch〕
100V	HMK212 B7103□G	RoHS	0.01	X7R	3.5	R	±10% ±20%	1.25±0.1 (0.049±0.004)
	HMK212 B7153□G	RoHS	0.015					
	HMK212 B7223□G	RoHS	0.022					
	HMK212 B7333□G	RoHS	0.033					
	HMK212 B7473□G	RoHS	0.047					
	HMK212 B7683□G	RoHS	0.068					
	HMK212 B7104□G	RoHS	0.1					
HMK212 B7224□G	RoHS	0.22						
250V	QMK212 B7102□D	RoHS	0.001		2.5			0.85±0.1 (0.033±0.004)
	QMK212 B7152□D	RoHS	0.0015					
	QMK212 B7222□D	RoHS	0.0022					
	QMK212 B7332□D	RoHS	0.0033					
	QMK212 B7472□G	RoHS	0.0047					
	QMK212 B7682□G	RoHS	0.0068					
	QMK212 B7103□G	RoHS	0.01					
	QMK212 B7153□G	RoHS	0.015					
	QMK212 B7223□G	RoHS	0.022	1.25±0.1 (0.049±0.004)				

形名の□には静電容量許容差記号が入ります。

Please specify the capacitance tolerance code.

アイテム一覧 PART NUMBERS

■ 316TYPE (1206 case size)

【温度特性 Temp.char. BJ:B/X5R】

定格電圧 Rated Voltage	形名 Ordering code	EHS (Environmental Hazardous Substances)	公称 静電容量 Capacitance [μ F]	温度特性 Temperature characteristics	$\tan \delta$ Dissipation factor [%] Max.	実装条件 Soldering method R:リフロー Reflow soldering W: フロ- Wave soldering	静電容量 許容差 Capacitance tolerance	厚み Thickness [mm] (inch)			
100V	HMK316 BJ473□L	RoHS	0.047	B/X5R*2	3.5	R	±10% ±20%	1.6±0.2 (0.063±0.008)			
	HMK316 BJ104□L	RoHS	0.1								
	HMK316 BJ154□L	RoHS	0.15								
	HMK316 BJ224□L	RoHS	0.22								
	HMK316 BJ334□L	RoHS	0.33								
	HMK316 BJ474□L	RoHS	0.47								
	HMK316 BJ105□L	RoHS	1								
250V	QMK316 BJ333□L	RoHS	0.033								
	QMK316 BJ473□L	RoHS	0.047								
	QMK316 BJ683□L	RoHS	0.068								
	QMK316 BJ104□L	RoHS	0.1								
630V	SMK316 BJ102□F	RoHS	0.001		2.5			2.5	R	±10% ±20%	1.15±0.1 (0.045±0.004)
	SMK316 BJ152□F	RoHS	0.0015								
	SMK316 BJ222□F	RoHS	0.0022								
	SMK316 BJ332□F	RoHS	0.0033								
	SMK316 BJ472□F	RoHS	0.0047								
	SMK316 BJ682□F	RoHS	0.0068								
	SMK316 BJ103□F	RoHS	0.01								
	SMK316 BJ153□L	RoHS	0.015								
SMK316 BJ223□L	RoHS	0.022	1.6±0.2 (0.063±0.008)								

形名の□には静電容量許容差記号が入ります。

Please specify the capacitance tolerance code.

*2 個別仕様の取交しにより、X7R仕様に対応している場合があります。

*2 We may provide X7R for some items according to the individual specification.

【温度特性 Temp.char. B7:X7R】

定格電圧 Rated Voltage	形名 Ordering code	EHS (Environmental Hazardous Substances)	公称 静電容量 Capacitance [μ F]	温度特性 Temperature characteristics	$\tan \delta$ Dissipation factor [%] Max.	実装条件 Soldering method R:リフロー Reflow soldering W: フロ- Wave soldering	静電容量 許容差 Capacitance tolerance	厚み Thickness [mm] (inch)			
100V	HMK316 B7 473□L	RoHS	0.047	X7R	3.5	R	±10% ±20%	1.6±0.2 (0.063±0.008)			
	HMK316 B7 104□L	RoHS	0.1								
	HMK316 B7 154□L	RoHS	0.15								
	HMK316 B7 224□L	RoHS	0.22								
	HMK316 B7 334□L	RoHS	0.33								
	HMK316 B7 474□L	RoHS	0.47								
	HMK316 B7 105□L	RoHS	1								
250V	QMK316 B7 333□L	RoHS	0.033								
	QMK316 B7 473□L	RoHS	0.047								
	QMK316 B7 683□L	RoHS	0.068								
	QMK316 B7 104□L	RoHS	0.1								
630V	SMK316 B7 102□F	RoHS	0.001		2.5			2.5	R	±10% ±20%	1.15±0.1 (0.045±0.004)
	SMK316 B7 152□F	RoHS	0.0015								
	SMK316 B7 222□F	RoHS	0.0022								
	SMK316 B7 332□F	RoHS	0.0033								
	SMK316 B7 472□F	RoHS	0.0047								
	SMK316 B7 682□F	RoHS	0.0068								
	SMK316 B7 103□F	RoHS	0.01								
	SMK316 B7 153□L	RoHS	0.015								
SMK316 B7 223□L	RoHS	0.022	1.6±0.2 (0.063±0.008)								

形名の□には静電容量許容差記号が入ります。

Please specify the capacitance tolerance code.

■ 325TYPE (1210 case size)

【温度特性 Temp.char. BJ:B/X5R】

定格電圧 Rated Voltage	形名 Ordering code		EHS (Environmental Hazardous Substances)	公称 静電容量 Capacitance 〔μF〕	温度特性 Temperature characteristics	tan δ Dissipation factor 〔%〕 Max.	実装条件 Soldering method R: リフロー- Reflow soldering W: フロ- Wave soldering	静電容量 許容差 Capacitance tolerance	厚み Thickness 〔mm〕 〔inch〕		
100V	HMK325 BJ104□F		RoHS	0.1	B/X5R*2	3.5	R	±10% ±20%	1.15±0.1 (0.045±0.004)		
	HMK325 BJ224□N		RoHS	0.22							
	HMK325 BJ474□N		RoHS	0.47							
	HMK325 BJ684□N		RoHS	0.68							
	HMK325 BJ105□N		RoHS	1							
250V	HMK325 BJ225□N		RoHS	2.2		2.5			R	±10% ±20%	1.9±0.2 (0.075±0.008)
	QMK325 BJ473□N		RoHS	0.047							
	QMK325 BJ104□N		RoHS	0.1							
	QMK325 BJ154□N		RoHS	0.15							
630V	QMK325 BJ224□N		RoHS	0.22		2.5			R	±10% ±20%	1.9±0.2 (0.075±0.008)
	SMK325 BJ223□N		RoHS	0.022							
	SMK325 BJ333□N		RoHS	0.033							
	SMK325 BJ473□N		RoHS	0.047							

形名の□には静電容量許容差記号が入ります。

□ Please specify the capacitance tolerance code.

*2 個別仕様の取交しにより、X7R仕様に対応している場合があります。

*2 We may provide X7R for some items according to the individual specification.

【温度特性 Temp.char. B7:X7R】

定格電圧 Rated Voltage	形名 Ordering code		EHS (Environmental Hazardous Substances)	公称 静電容量 Capacitance 〔μF〕	温度特性 Temperature characteristics	tan δ Dissipation factor 〔%〕 Max.	実装条件 Soldering method R: リフロー- Reflow soldering W: フロ- Wave soldering	静電容量 許容差 Capacitance tolerance	厚み Thickness 〔mm〕 〔inch〕		
100V	HMK325 B7 104□F		RoHS	0.1	X7R	3.5	R	±10% ±20%	1.15±0.1 (0.045±0.004)		
	HMK325 B7 224□N		RoHS	0.22							
	HMK325 B7 474□N		RoHS	0.47							
	HMK325 B7 684□N		RoHS	0.68							
	HMK325 B7 105□N		RoHS	1							
250V	HMK325 B7 225□N		RoHS	2.2		2.5			R	±10% ±20%	1.9±0.2 (0.075±0.008)
	QMK325 B7 473□N		RoHS	0.047							
	QMK325 B7 104□N		RoHS	0.1							
	QMK325 B7 154□N		RoHS	0.15							
630V	QMK325 B7 224□N		RoHS	0.22		2.5			R	±10% ±20%	1.9±0.2 (0.075±0.008)
	SMK325 B7 223□N		RoHS	0.022							
	SMK325 B7 333□N		RoHS	0.033							
	SMK325 B7 473□N		RoHS	0.047							

形名の□には静電容量許容差記号が入ります。

□ Please specify the capacitance tolerance code.

■ 432TYPE (1812 case size)

【温度特性 Temp.char. BJ:B/X5R】

定格電圧 Rated Voltage	形名 Ordering code	EHS (Environmental Hazardous Substances)	公称 静電容量 Capacitance [μF]	温度特性 Temperature characteristics	tan δ Dissipation factor [%] Max.	実装条件 Soldering method R:リフロー Reflow soldering W: フロー Wave soldering	静電容量 許容差 Capacitance tolerance	厚み Thickness [mm] (inch)
100V	HMK432 BJ474□M	RoHS	0.47	B/X5R*2	3.5	R	±10% ±20%	2.5±0.2 (0.098±0.008)
	HMK432 BJ105□M	RoHS	1					
	HMK432 BJ155□M	RoHS	1.5					
	HMK432 BJ225□M	RoHS	2.2					
250V	QMK432 BJ104□M	RoHS	0.1					
	QMK432 BJ224□M	RoHS	0.22					
	QMK432 BJ334□M	RoHS	0.33					
	QMK432 BJ474□M	RoHS	0.47					
630V	SMK432 BJ473□M	RoHS	0.047					
	SMK432 BJ683□M	RoHS	0.068					
	SMK432 BJ104□M	RoHS	0.1					

形名の□には静電容量許容差記号が入ります。

Please specify the capacitance tolerance code.

*2 個別仕様の取交しにより、X7R仕様に对应している場合があります。

*2 We may provide X7R for some items according to the individual specification.

【温度特性 Temp.char. B7:X7R】

定格電圧 Rated Voltage	形名 Ordering code	EHS (Environmental Hazardous Substances)	公称 静電容量 Capacitance [μF]	温度特性 Temperature characteristics	tan δ Dissipation factor [%] Max.	実装条件 Soldering method R:リフロー Reflow soldering W: フロー Wave soldering	静電容量 許容差 Capacitance tolerance	厚み Thickness [mm] (inch)
100V	HMK432 B7 474□M	RoHS	0.47	X7R	3.5	R	±10% ±20%	2.5±0.2 (0.098±0.008)
	HMK432 B7 105□M	RoHS	1					
	HMK432 B7 155□M	RoHS	1.5					
	HMK432 B7 225□M	RoHS	2.2					
250V	QMK432 B7 104□M	RoHS	0.1					
	QMK432 B7 224□M	RoHS	0.22					
	QMK432 B7 334□M	RoHS	0.33					
	QMK432 B7 474□M	RoHS	0.47					
630V	SMK432 B7 473□M	RoHS	0.047					
	SMK432 B7 683□M	RoHS	0.068					
	SMK432 B7 104□M	RoHS	0.1					

形名の□には静電容量許容差記号が入ります。

Please specify the capacitance tolerance code.

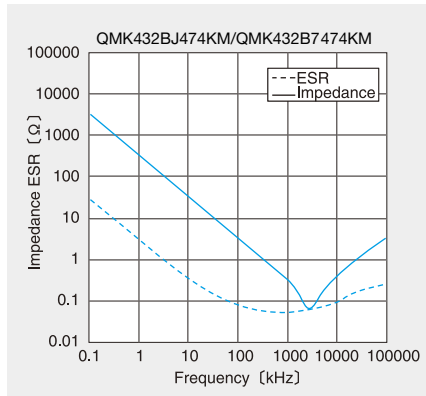
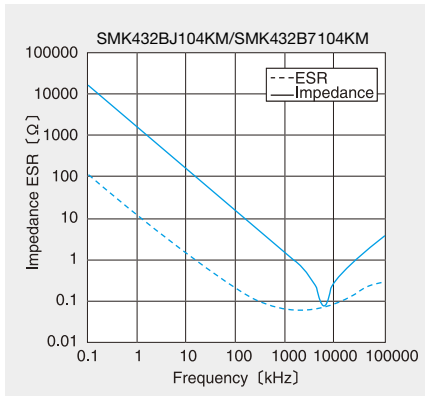
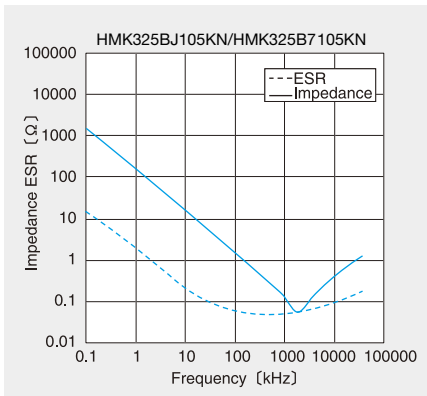
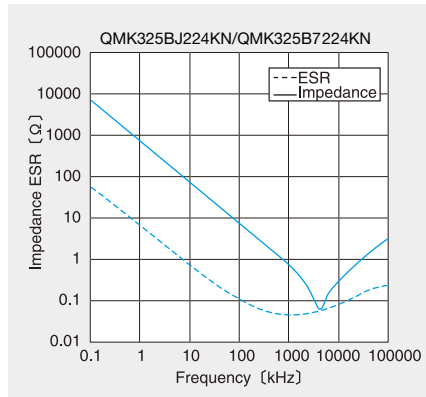
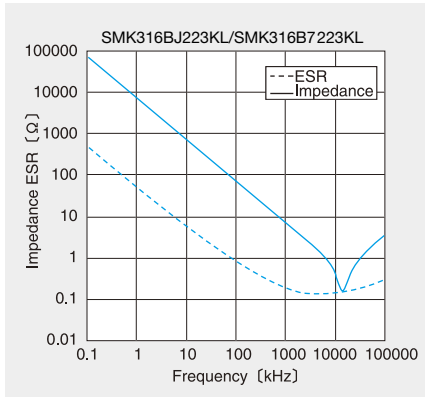
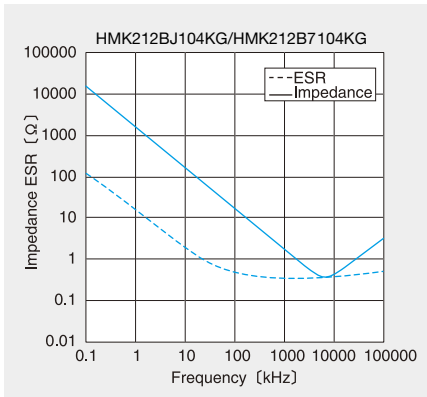

静電容量—温度特性 Temperature characteristics

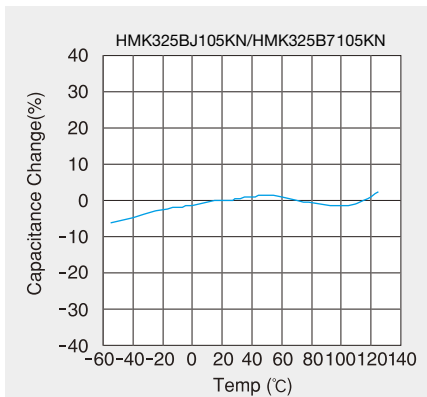

MEDIUM—HIGH VOLTAGE MULTILAYER CERAMIC CAPACITOR

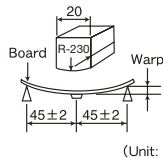
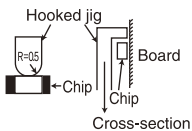
Item	Specified Value	Test Methods and Remarks
1. Operating Temperature Range	X7R, X7S: -55 to +125°C B: -25 to +85°C	
2. Storage Temperature Range	X7R, X7S: -55 to +125°C B: -25 to +85°C	
3. Rated Voltage	100VDC, 250VDC, 630VDC	
4. Withstanding Voltage Between terminals	No breakdown or damage	Applied voltage: Rated voltage × 2.5 (100V) Rated voltage × 2 (250V) Rated voltage × 1.2 (630V) Duration: 1 ~ 5 sec. Charge/discharge current: 50mAmax.
5. Insulation Resistance	100MΩ μ F or 10GΩ, whichever is smaller.	Applied voltage: Rated voltage (100V, 250V) 500V (630V) Duration: 60 ± 5 sec. Charge/discharge current: 50mAmax.
6. Capacitance (Tolerance)	±20%、±10%	Measuring frequency: 1kHz ± 10% Measuring voltage: 1 ± 0.2Vrms Bias application: None
7. Tangent of Loss Angel	3.5% max (100V). 2.5% max (250V, 630V).	Measuring frequency: 1kHz ± 10% Measuring voltage: 1 ± 0.2Vrms Bias application: None
8. Temperature Characteristic of Capacitance	B: ±10% (-25 to +85°C) X7R: ±15% (-55 to +125°C) X7S: ±22% (-55 to +125°C)	According to JIS 5102 clause 7.12. Charge of maximum capacitance deviation in step 1 to 5 Temperature at step 1: +25°C Temperature at step 2: minimum operating temperature Temperature at step 3: +25°C (Reference temperature) Temperature at step 4: maximum operating temperature Temperature at step 5: +25°C Reference temperature Characteristic B shall be +20°C
9. Resistance to Flexure of Substrate	Appearance: No abnormality Capacitance change: Within ±10%	Warp: 1mm Testing board: glass epoxy—resin substrate Thickness: 1.6mm The measurement shall be made with board in the bent position  (Unit: mm)
10. Adhesion of Electrode	No separation or indication of separation of electrode	Applied force: 5N Duration: 30 ± 5 sec.  Cross-section
11. Solderability	At least 75% of terminal electrode is covered by solder	Solder temperature: 230 ± 5°C Duration: 4 ± 1 sec.
12. Resistance to Soldering	Appearance: No abnormality Capacitance change: Within ±15% (100V), ±10% (250V, 630V) tan δ: Initial value Insulation resistance: Initial value Withstanding voltage (between terminals): No abnormality	Preconditioning: Thermal treatment (at 150°C for 1hr) Solder temperature: 270 ± 5°C Duration: 3 ± 0.5 sec. Preheating conditions: 80 to 100°C, 2 to 5 min. 150 to 200°C, 2 to 5 min. Recovery: Recovery for the following period under the standard condition after the test. 24 ± 2 hrs
13. Thermal shock	Appearance: No abnormality Capacitance change: Within ±15% (100V), ±7.5% (250V, 630V) tan δ: Initial value Insulation resistance: Initial value	Preconditioning: Thermal treatment (at 150°C for 1hr) Conditions for 1 cycle Step 1: Minimum operating temperature +0/-3°C 30 ± 3 min. Step 2: Room temperature 2 to 3 min. Step 3: Maximum operating temperature +0/-3°C 30 ± 3 min. Step 4: Room temperature 2 to 3 min. Number of cycles: 5 times Recovery after the test: 24 ± 2 hrs

Item	Specified Value	Test Methods and Remarks
14.Damp Heat (steady state)	Appearance:No abnormality Capacitance change: Within±15% $\tan \delta$: 7%max (100V), 5%max (250V, 630V). Insulation resistance:25M Ω μ F or 1000M Ω Whichever is smaller.	Preconditioning:Thermal treatment (at 150°C for 1hr) Temperature:40±2°C Humidity : 90 to 95%RH Duration: 500+24/−0 hrs Recovery:Rcovery for the following period under the standerd condition after the removal from test chamber. 24±2hrs
15.Loading under Damp Heat	Appearance:No abnormality Capacitance change: Within±15% $\tan \delta$: 7%max (100V), 5%max (250V, 630V). Insulation resistance:10M Ω μ F or 500M Ω Whichever is smaller.	Preconditioning:Thermal treatment (at 150°C for 1hr) Preconditioning:Voltage treatment Temperature:40±2°C Humidity : 90 to 95%RH Applied voltage:Rated voltage Chage/dischage current : 50mAmax. Duration: 500+24/−0 hrs Recovery:Rcovery for the following period under the standerd condition after the removal from test chamber. 24±2hrs
16.Loading at High Temperature	Appearance:No abnormality Capacitance change: Within±15% $\tan \delta$: 7%max (100V), 5%max (250V, 630V). Insulation resistance:50M Ω μ F or 1000M Ω Whichever is smaller.	According to JIS 5102 clause 9.10. Preconditioning:Voltage treatment Temperature:125±3°C (X7R, X7S) 85±2°C (BJ) Applied voltage:Rated voltage x 2 (100V) Rated voltage x 1.5 (250V) Rated voltage x 1.2 (630V) Chage/dischage current : 50mAmax. Duration: 1000+24/−0 hrs Recovery:Rcovery for the following period under the standerd condition after the removal from test chamber. As for thermal treatment shall be performed prior to the recovery. 24±2hrs

LW逆転タイプ積層セラミックコンデンサ (LWDC™)

LW REVERSAL DECOUPLING CAPACITOR (LWDC™)

	Code	Temp.characteristics	Operating temp. range
OPERATING TEMP.	BJ	B	-25~+85°C
		X5R*	-55~+85°C
	B7	X7R	-55~+125°C
	C6	X6S	-55~+105°C
	C7	X7S	-55~+125°C

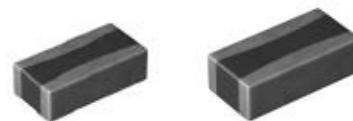

*個別仕様の取交しにより、X6S/X7S/X7R 仕様に対応している場合があります。

*We may provide X6S/X7S/X7R for some items according to the individual specification.

特長 FEATURES

- ・等価直列抵抗 (ESR) が小さい
- ・等価直列インダクタンス (ESL) が小さい
- ・高周波でのノイズ除去効果が高い
- ・リップル電圧低減
- ・小型大容量化を実現
- ・ Low equivalent series resistance (ESR)
- ・ Low equivalent series inductor (ESL)
- ・ The effect of noise removal in the high frequency
- ・ The ripple voltage is decreased
- ・ Small size, High capacitance

用途 APPLICATIONS

- ・デカップリングコンデンサ
- ・平滑コンデンサ (DC-DCコンバータ, スイッチング電源)
- ・ Decoupling capacitors
- ・ Filtering capacitors

形名表記法 ORDERING CODE

1 定格電圧 (VDC)	3 端子電極	5 温度特性	7 容量許容差	9 個別仕様
A 4 J 6.3	K ムッキ品	BJ B X5R B7 X7R C6 X6S C7 X7S	K ±10% M ±20%	- 標準
2 シリーズ名	4 形状寸法 (EIA) L×W (mm)	6 公称静電容量 (μF)	8 製品厚み (mm)	10 包装
W LW逆転タイプ	105 (0204) 0.52×1.0 107 (0306) 0.8×1.6 212 (0508) 1.25×2.0	例 1.0 105 1.0 106 10.0	P 0.3 V 0.5 A 0.8 D 0.85	T φ178mm テーピング (4mmピッチ) 107, 212形状 F φ178mm テーピング (2mmピッチ) 105形状
				11 当社管理記号
				△ 標準品 △=スペース

J W K 2 1 2 B J 1 0 6 M D - T △

1 2 3 4 5 6 7 8 9 10 11

1 Rated voltage (VDC)	3 End termination	5 Temperature characteristics code	7 Capacitance tolerance	9 Special code
A 4 J 6.3	K Plated	BJ B X5R B7 X7R C6 X6S C7 X7S	K ±10% M ±20%	- Standard products
2 Series name	4 Dimensions(case size) (mm)	6 Nominal capacitance (μF)	8 Thickness (mm)	10 Packaging
W LW Reverse Type	105 (0204) 0.52×1.0 107 (0306) 0.8×1.6 212 (0508) 1.25×2.0	example 1.0 105 1.0 106 10.0	P 0.3 V 0.5 A 0.8 D 0.85	T φ178mm Taping (4mm pitch) 0306, 0508 Type F φ178mm Taping (2mm pitch) 0204 Type
				11 Internal code
				△ Standard products △=Blank space

外形寸法 EXTERNAL DIMENSIONS

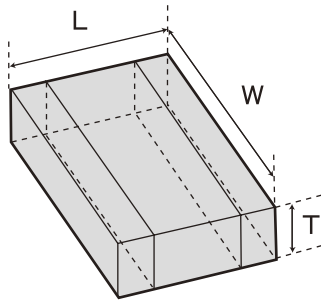

Type(EIA)	L	W	T	
□WK105 (0204)	0.52±0.05 (0.020±0.002)	1.00±0.05 (0.039±0.002)	P	0.30±0.05 (0.012±0.002)
□WK107 (0306)	0.80±0.10 (0.031±0.004)	1.60±0.10 (0.063±0.004)	V	0.50±0.05 (0.020±0.002)
			A	0.80±0.10 (0.031±0.004)
□WK212 (0508)	1.25±0.15 (0.049±0.006)	2.00±0.15 (0.079±0.006)	D	0.85±0.10 (0.033±0.004)

Unit:mm (inch)

概略バリエーション AVAILABLE CAPACITANCE RANGE

Cap [μF]	Type	105				107				212		
	Temp.Char	X7S	X6S	X5R		X7R	X7S		X5R		X6S	X5R
	VDC	6.3	4	6.3	4	6.3	6.3	4	6.3	4	6.3	6.3
[pF:3digits]												
0.10	104	P		P								
0.22	224		P		P	V			V			
1.0	105						V		V			
2.2	225							V		V		
4.7	475										D	D
10.0	106										D	D

※グラフ記号は製品厚みを表します。

Letters inside the shaded boxes indicate thickness.

温度特性コード Temp.char.Code	温度特性 Temperature characteristics					静電容量許容差[%] Capacitance tolerance	tan δ[%] Dissipation factor
	準拠規格 Applicable standard		温度範囲[°C] Temperature range	基準温度[°C] Ref. Temp.	静電容量変化率[%] Capacitance change		
	JIS	B					
BJ	EIA	X5R	-25~+85	20	±10	±10 (K) ±20 (M)	10 max.*
	EIA	X7R	-55~+85	25	±15		
B7	EIA	X7R	-55~+125	25	±15		
C6	EIA	X6S	-55~+105	25	±22		
C7	EIA	X7S	-55~+125	25	±22		

*: 代表的な値を記載しています。詳細はアイテム一覧表を参照ください。

*: The figure indicates typical value. Please refer to PART NUMBERS table.

セレクションガイド
Selection Guide



etc

アイテム一覧
Part Numbers



特性図
Electrical Characteristics



梱包
Packaging



信頼性
Reliability Data



使用上の注意
Precautions



■ 105TYPE (0204 case size)

【温度特性 Temp.char. BJ:X5R】

定格電圧 Rated Voltage	形名 Ordering code		EHS (Environmental Hazardous Substances)	公称 静電容量 Capacitance 〔 μ F〕	温度特性 Temperature characteristics	tan δ Dissipation factor 〔%〕 Max.	実装条件 Soldering method R: リフロー- Reflow soldering W: 7口- Wave soldering	静電容量 許容差 Capacitance tolerance	厚み Thickness 〔mm〕 〔inch〕
6.3V	JWK105 BJ104MP*1		RoHS	0.1	X5R*2	5	R	±20%〔M〕	0.3±0.05 (0.012±0.002)
4V	AWK105 BJ224MP*1		RoHS	0.22		10			

*1 高温負荷試験の試験電圧は定格電圧の 1.5 倍

*2 個別仕様の取交しにより、X6S/X7S仕様に対応している場合があります。

*1 Test Voltage of Loading at high temperature test is 1.5 time of the rated voltage.

*2 We may provide X6S/X7S for some items according to the individual specification.

【温度特性 Temp.char. C6:X6S C7:X7S】

定格電圧 Rated Voltage	形名 Ordering code		EHS (Environmental Hazardous Substances)	公称 静電容量 Capacitance 〔 μ F〕	温度特性 Temperature characteristics	tan δ Dissipation factor 〔%〕 Max.	実装条件 Soldering method R: リフロー- Reflow soldering W: 7口- Wave soldering	静電容量 許容差 Capacitance tolerance	厚み Thickness 〔mm〕 〔inch〕
6.3V	JWK105 C7 104MP*1		RoHS	0.1	X7S	5	R	±20%〔M〕	0.3±0.05 (0.012±0.002)
4V	AWK105 C6224MP*1		RoHS	0.22	X6S	10			

*1 高温負荷試験の試験電圧は定格電圧の 1.5 倍

*1 Test Voltage of Loading at high temperature test is 1.5 time of the rated voltage.

■ 107TYPE (0306 case size)

【温度特性 Temp.char. BJ:X5R】

定格電圧 Rated Voltage	形名 Ordering code		EHS (Environmental Hazardous Substances)	公称 静電容量 Capacitance 〔 μ F〕	温度特性 Temperature characteristics	tan δ Dissipation factor 〔%〕 Max.	実装条件 Soldering method R: リフロー- Reflow soldering W: 7口- Wave soldering	静電容量 許容差 Capacitance tolerance	厚み Thickness 〔mm〕 〔inch〕
6.3V	JWK107 BJ224MV*1		RoHS	0.22	X5R*2	5	R	±20%〔M〕	0.5±0.05 (0.020±0.002)
	JWK107 BJ105MV*1		RoHS	1		10			
4V	AWK107 BJ225MV*1		RoHS	2.2					

*1 高温負荷試験の試験電圧は定格電圧の 1.5 倍

*2 個別仕様の取交しにより、X7R/X7S仕様に対応している場合があります。

*1 Test Voltage of Loading at high temperature test is 1.5 time of the rated voltage.

*2 We may provide X7R/X7S for some items according to the individual specification.

【温度特性 Temp.char. B7:X7R C7:X7S】

定格電圧 Rated Voltage	形名 Ordering code		EHS (Environmental Hazardous Substances)	公称 静電容量 Capacitance 〔 μ F〕	温度特性 Temperature characteristics	tan δ Dissipation factor 〔%〕 Max.	実装条件 Soldering method R: リフロー- Reflow soldering W: 7口- Wave soldering	静電容量 許容差 Capacitance tolerance	厚み Thickness 〔mm〕 〔inch〕
6.3V	JWK107 B7 224MV*1		RoHS	0.22	X7R	5	R	±20%〔M〕	0.5±0.05 (0.020±0.002)
	JWK107 C7 105MV*1		RoHS	1	X7S	10			
4V	AWK107 C7 225MV*1		RoHS	2.2					

*1 高温負荷試験の試験電圧は定格電圧の 1.5 倍

*1 Test Voltage of Loading at high temperature test is 1.5 time of the rated voltage.

■ 212TYPE (0508 case size)

【温度特性 Temp.char. BJ:X5R】

定格電圧 Rated Voltage	形名 Ordering code	EHS (Environmental Hazardous Substances)	公称 静電容量 Capacitance [μ F]	温度特性 Temperature characteristics	$\tan \delta$ Dissipation factor [%] Max.	実装条件 Soldering method R:リフロー Reflow soldering W: フロー Wave soldering	静電容量 許容差 Capacitance tolerance	厚み Thickness [mm] [inch]
6.3V	JWK212 BJ475□D*1	RoHS	4.7	X5R*2	10	R	±10% [K] ±20% [M]	0.85±0.1 (0.033±0.004)
	JWK212 BJ106MD*1	RoHS	10				±20% [M]	

形名の□には静電容量許容差記号が入ります。

*1 高温負荷試験の試験電圧は定格電圧の1.5倍

*2 個別仕様の取交しにより、X6S仕様に対応している場合があります。

Please specify the capacitance tolerance code.

*1 Test Voltage of Loading at high temperature test is 1.5 time of the rated voltage.

*2 We may provide X6S for some items according to the individual specification.

【温度特性 Temp.char. C6:X6S】

定格電圧 Rated Voltage	形名 Ordering code	EHS (Environmental Hazardous Substances)	公称 静電容量 Capacitance [μ F]	温度特性 Temperature characteristics	$\tan \delta$ Dissipation factor [%] Max.	実装条件 Soldering method R:リフロー Reflow soldering W: フロー Wave soldering	静電容量 許容差 Capacitance tolerance	厚み Thickness [mm] [inch]
6.3V	JWK212 C6475□D*1	RoHS	4.7	X6S	10	R	±10% [K] ±20% [M]	0.85±0.1 (0.033±0.004)
	JWK212 C6106MD*1	RoHS	10				±20% [M]	

形名の□には静電容量許容差記号が入ります。

*1 高温負荷試験の試験電圧は定格電圧の1.5倍

Please specify the capacitance tolerance code.

*1 Test Voltage of Loading at high temperature test is 1.5 time of the rated voltage.

特性図 ELECTRICAL CHARACTERISTICS

インピーダンス・ESR-周波数特性例 Example of Impedance ESR vs. Frequency characteristics

・当社積層セラミックコンデンサ例 (Taiyo Yuden multilayer ceramic capacitor)

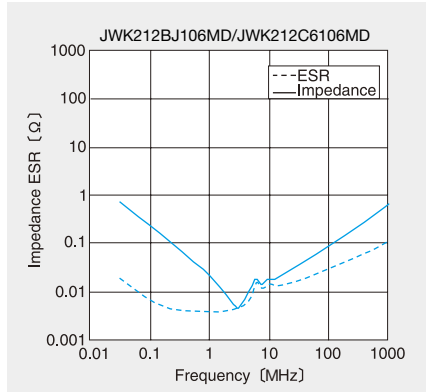
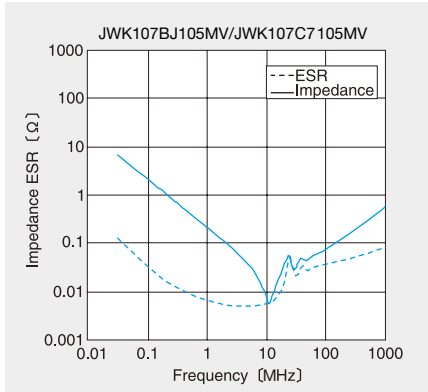

アレイ形積層セラミックコンデンサ

ARRAY TYPE MULTILAYER CERAMIC CAPACITOR



リフロー／REFLOW

	Code	Temp.characteristics	Operating temp. range
OPERATING TEMP.	BJ	B	-25~+85°C
		X5R*	-55~+85°C
	B7	X7R	-55~+125°C
	CH	C0H	-55~+125°C

*個別仕様の取交しにより、X7R仕様に対応している場合があります。

*We may provide X7R for some items according to the individual specification.

特長 FEATURES

- ・高密度、高効率な実装を実現
- ・内部電極には、信頼性とコストパフォーマンスに優れたNiを使用しています。
- ・ High density and high efficiency mounting.
- ・ Internal electrode is nickel for increased cost performance and reliability.

用途 APPLICATIONS

- ・ 一般電子機器用
- ・ 通信機器用 (携帯電話、PHS、コードレス電話etc)
- ・ General electronic equipment
- ・ Communication equipment (mobile phone, PHS, cordless phone, etc.)

形名表記法 ORDERING CODE

1 定格電圧 (VDC)	3 端子電極	5 温度特性	7 容量許容差	9 個別仕様
J 6.3 L 10 E 16 T 25 U 50	K ムッキ品	BJ B B7 X5R CH X7R C0H C0H	M ±20% K ±10% F ±1pF	- 標準
2 シリーズ名	4 形状寸法 (EIA) L×W (mm)	6 公称静電容量 (pF)	8 製品厚み (mm)	10 包装
4 4連積層コンデンサ 2 2連積層コンデンサ	096 (0302) 0.9×0.6 110 (0504) 1.4×1.0 212 (0805) 2.0×1.25	例 104 100,000 105 1,000,000	P 0.3 K 0.45 V 0.5 B 0.6 A 0.8 D 0.85	T φ178mm テーピング (4mmピッチ) 110, 212形状 F φ178mm テーピング (2mmピッチ) 096形状
				11 当社管理記号
				△ 標準品 △=スペース

1	2	3	4	5	6	7	8	9	10	11
1 Rated voltage (VDC)	2 Series name	3 End termination	4 Dimensions(case size) (mm)	5 Temperature characteristics code	6 Nominal capacitance (pF)	7 Capacitance tolerance	8 Thickness (mm)	9 Special code	10 Packaging	11 Internal code
J 6.3 L 10 E 16 T 25 U 50	4 4 circuit multilayer capacitors 2 2 circuit multilayer capacitors	K Plated	096 (0302) 0.9×0.6 110 (0504) 1.4×1.0 212 (0805) 2.0×1.25	BJ B B7 X5R CH X7R C0H C0H	example 104 100,000 105 1,000,000	M ±20% K ±10% F ±1pF	P 0.3 K 0.45 V 0.5 B 0.6 A 0.8 D 0.85	- Standard products	T φ178mm Taping (4mm pitch) 0504, 0805Type F φ178mm Taping (2mm pitch) 0302Type	△ Standard products △=Blank space

外形寸法 EXTERNAL DIMENSIONS

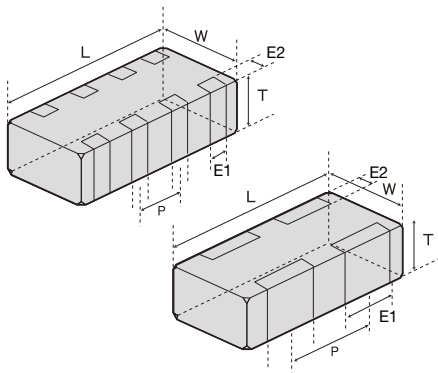

Type (EIA)	L	W	E1	E2	P	T	
□2K096 (0302)	0.9±0.05 (0.035±0.002)	0.6±0.05 (0.024±0.002)	0.23±0.10 (0.009±0.004)	0.125±0.075 (0.005±0.003)	0.45±0.05 (0.018±0.002)	P	0.30±0.03 (0.012±0.001)
						K	0.45±0.05 (0.018±0.002)
						V	0.5±0.05 (0.020±0.002)
□2K110 (0504)	1.37±0.07 (0.054±0.003)	1.00±0.08 (0.039±0.003)	0.36±0.10 (0.014±0.004)	0.2±0.10 (0.008±0.004)	0.64±0.10 (0.025±0.004)	B	0.60±0.06 (0.024±0.003)
						A	0.80±0.08 (0.031±0.003)
□4K212 (0805)	2.00±0.10 (0.079±0.004)	1.25±0.10 (0.049±0.004)	0.25±0.10 (0.010±0.004)	0.25±0.15 (0.010±0.006)	0.50±0.10 (0.020±0.004)	D	0.85±0.10 (0.033±0.004)
□2K212 (0805)	2.00±0.10 (0.079±0.004)	1.25±0.10 (0.049±0.004)	0.50±0.20 (0.020±0.008)	0.25±0.15 (0.010±0.006)	1.00±0.10 (0.039±0.004)	D	0.85±0.10 (0.033±0.004)

Unit:mm (inch)

概略バリエーション AVAILABLE CAPACITANCE RANGE

BJ / X7R, BJ / X5R

Cap [μF]	Type	110 2連										212 2連		212 4連					
		□2K096		□2K110								□2K212		□4K212					
		Temp.Char	B/X5R	X5R	B/X7R			B/X5R			X5R	B/X5R	X5R	B/X7R	B/X5R		X5R		
VDC	10V	6.3V	50V	25V	16V	50V	25V	16V	10V	10V	6.3V	25V	10V	16V	25V	16V	10V	10V	
[pF:3digits]			B			B			B										
0.001	102			B			B												
0.0022	222			B			B												
0.0047	472			B			B												
0.01	103	P			B			B											
0.022	223			B			B												
0.047	473		K		B			B											
0.1	104		K		B			B	B										
0.22	224		K							B								D	
0.47	474										A								D
1.0	105										A	V	D						D
2.2	225											A		D					

※グラフ記号は製品厚みを表します。 Letters in the table indicate thickness.

CH / C0H/CG (C0G)

Cap [pF]	Type	096 2連		110 2連	
		□2K096		□2K110	
		Temp.Char	CH / CG	CH / CG	CH / CG
VDC	25V	50V			
[pF:3digits]					
10	100	P	B		
12	120	P	B		
15	150	P	B		
18	180	P	B		
22	220	P	B		
27	270	P	B		
33	330	P	B		
39	390	P	B		
47	470	P	B		
56	560	P	B		
68	680	P	B		
82	820	P	B		
100	101	P	B		

※グラフ記号は製品厚みを表します。 Letters in the table indicate thickness.

温度特性コード Temp.char.Code	温度特性 Temperature characteristics					静電容量許容差[%] Capacitance tolerance	tan δ [%] Dissipation factor
	準拠規格 Applicable standard		温度範囲[°C] Temperature range	基準温度[°C] Ref. Temp.	静電容量変化率 Capacitance change		
	JIS	B	-25~+85	20	±10[%]		
BJ	EIA	X5R	-55~+85	25	±15[%]	±10(K) ±20(M)	3.5, 5, 10 max.*
	EIA	X7R	-55~+125	25	±15[%]		
CH	JIS	CH	-55~+125	20	±60 [ppm/°C]	±10(K)	0.1 max.**
	EIA	C0H	-55~+125	25	±60 [ppm/°C]		

- *: アイテムによって異なります。アイテム一覧表を参照下さい。
- ** : 27pF以下 Q≧400+20・C 30pF以上 Q≧1000
- * : Different depending on the item. Please refer to the part numbers list for the differences.
- ** : 27pF or over Q≧400+20・C 30pF or over Q≧1000

セレクションガイド
Selection Guide

◀ P.12

etc

アイテム一覧
Part Numbers

P.94 ▶

特性図
Electrical Characteristics

P.97 ▶

梱包
Packaging

P.98 ▶

信頼性
Reliability Data

P.102 ▶

使用上の注意
Precautions

P.108 ▶

■ 096TYPE(0302 case size) 2連タイプ(2 circuit type)

【温度特性 Temp.char. BJ:B/X5R】

定格電圧 Rated Voltage	形名 Ordering code	EHS (Environmental Hazardous Substances)	公称 静電容量 Capacitance [μ F]	温度特性 Temperature characteristics	tan δ Dissipation factor [%] Max.	実装条件 Soldering method R:リフロー Reflow soldering W: フロー Wave soldering	静電容量 許容差 Capacitance tolerance	厚み Thickness [mm] (inch)
10V	L2K096 BJ103□P	RoHS	0.01	B/X5R	5	R	±10% [K] ±20% [M]	0.3±0.03 (0.012±0.001)
6.3V	J2K096 BJ473□K* ¹	RoHS	0.047	X5R				10
	J2K096 BJ104□K* ¹	RoHS	0.1					
	J2K096 BJ224MK* ¹	RoHS	0.22				±20% [M]	

形名の□には静電容量許容差記号が入ります。

□ Please specify the capacitance tolerance code.

*1 高温負荷試験の試験電圧は、定格電圧の1.5倍

*1 Test voltage of loading at high temperature test is 1.5 time of the rated voltage.

【温度特性 Temp.char. CH:CH/C0H】

定格電圧 Rated Voltage	形名 Ordering code	EHS (Environmental Hazardous Substances)	公称 静電容量 Capacitance [pF]	温度特性 Temperature characteristics	Q Symbol	実装条件 Soldering method R:リフロー Reflow soldering W: フロー Wave soldering	静電容量 許容差 Capacitance tolerance	厚み Thickness [mm] (inch)
25V	T2K096 CH100FP	RoHS	10	CH/C0H	400+20・C	R	±10% [K]	0.3±0.03 (0.012±0.001)
	T2K096 CH120KP	RoHS	12					
	T2K096 CH150KP	RoHS	15					
	T2K096 CH180KP	RoHS	18					
	T2K096 CH220KP	RoHS	22					
	T2K096 CH270KP	RoHS	27					
	T2K096 CH330KP	RoHS	33		1000			
	T2K096 CH390KP	RoHS	39					
	T2K096 CH470KP	RoHS	47					
	T2K096 CH560KP	RoHS	56					
	T2K096 CH680KP	RoHS	68					
	T2K096 CH820KP	RoHS	82					
	T2K096 CH101KP	RoHS	100					

■ 110TYPE (0504 case size) 2連タイプ(2 circuit type)

【温度特性 Temp.char. BJ:B/X5R】

定格電圧 Rated Voltage	形名 Ordering code	EHS (Environmental Hazardous Substances)	公称 静電容量 Capacitance 〔μF〕	温度特性 Temperature characteristics	tan δ Dissipation factor 〔%〕 Max.	実装条件 Soldering method R:リフロー- Reflow soldering W: 7口- Wave soldering	静電容量 許容差 Capacitance tolerance	厚み Thickness 〔mm〕 〔inch〕
50V	U2K110 BJ102□B	RoHS	0.001	B/X5R*2	3.5	R	±10%〔K〕 ±20%〔M〕	0.6±0.06 (0.024±0.002)
	U2K110 BJ222□B	RoHS	0.0022					
	U2K110 BJ472□B	RoHS	0.0047					
25V	T2K110 BJ103□B	RoHS	0.01					
	T2K110 BJ223□B	RoHS	0.022					
	T2K110 BJ104□B	RoHS	0.1					
16V	E2K110 BJ473□B	RoHS	0.047	B/X5R*2	5			
	E2K110 BJ104□B	RoHS	0.1	B/X5R*2	3.5			
10V	L2K110 BJ224□B	RoHS	0.22	B/X5R	5			
	L2K110 BJ474□A	RoHS	0.47					
	L2K110 BJ105□A*1	RoHS	1.0					
6.3V	J2K110 BJ105□V*1	RoHS	1.0	X5R	10			
	J2K110 BJ225□A*1	RoHS	2.2					

形名の□には静電容量許容差記号が入ります。

*1 高温負荷試験の試験電圧は、定格電圧の1.5倍

*2 個別仕様の取交しにより、X7R仕様に对应している場合があります。

□ Please specify the capacitance tolerance code.

*1 Test voltage of loading at high temperature test is 1.5 time of the rated voltage.

*2 We may provide X7R for some items according to the individual specification.

【温度特性 Temp.char. B7:X7R】

定格電圧 Rated Voltage	形名 Ordering code	EHS (Environmental Hazardous Substances)	公称 静電容量 Capacitance 〔μF〕	温度特性 Temperature characteristics	tan δ Dissipation factor 〔%〕 Max.	実装条件 Soldering method R:リフロー- Reflow soldering W: 7口- Wave soldering	静電容量 許容差 Capacitance tolerance	厚み Thickness 〔mm〕 〔inch〕
50V	U2K110 B7 102□B	RoHS	0.001	X7R	3.5	R	±10%〔K〕 ±20%〔M〕	0.6±0.06 (0.024±0.002)
	U2K110 B7 222□B	RoHS	0.0022					
	U2K110 B7 472□B	RoHS	0.0047					
25V	T2K110 B7 103□B	RoHS	0.01					
	T2K110 B7 223□B	RoHS	0.022					
16V	E2K110 B7 473□B	RoHS	0.047		5			
	E2K110 B7 104□B	RoHS	0.1					

形名の□には静電容量許容差記号が入ります。

□ Please specify the capacitance tolerance code.

【温度特性 Temp.char. CH:CH/C0H】

定格電圧 Rated Voltage	形名 Ordering code	EHS (Environmental Hazardous Substances)	公称 静電容量 Capacitance 〔pF〕	温度特性 Temperature characteristics	Q Symbol	実装条件 Soldering method R:リフロー- Reflow soldering W: 7口- Wave soldering	静電容量 許容差 Capacitance tolerance	厚み Thickness 〔mm〕 〔inch〕
50V	U2K110 CH100FB	RoHS	10	CH/C0H	400+20・C	R	±10%〔K〕	0.6±0.06 (0.024±0.002)
	U2K110 CH120KB	RoHS	12					
	U2K110 CH150KB	RoHS	15					
	U2K110 CH180KB	RoHS	18					
	U2K110 CH220KB	RoHS	22					
	U2K110 CH270KB	RoHS	27					
	U2K110 CH330KB	RoHS	33					
	U2K110 CH390KB	RoHS	39					
	U2K110 CH470KB	RoHS	47		1000			
	U2K110 CH560KB	RoHS	56					
	U2K110 CH680KB	RoHS	68					
	U2K110 CH820KB	RoHS	82					
	U2K110 CH101KB	RoHS	100					

■ 212TYPE(0805 case size) 2連タイプ(2 circuit type)

【温度特性 Temp.char. BJ:B/X5R】

定格電圧 Rated Voltage	形名 Ordering code		EHS (Environmental Hazardous Substances)	公称 静電容量 Capacitance [μF]	温度特性 Temperature characteristics	tan δ Dissipation factor [%] Max.	実装条件 Soldering method R:リフロー Reflow soldering W: フロー Wave soldering	静電容量 許容差 Capacitance tolerance	厚み Thickness [mm] (inch)
25V	T2K212 BJ105□D		RoHS	1.0	B/X5R	5	R	±10% [K] ±20% [M]	0.85±0.1 (0.033±0.004)
10V	L2K212 BJ225MD*1		RoHS	2.2	X5R	10		±20% [M]	

形名の□には静電容量許容差記号が入ります。

*1 高温負荷試験の試験電圧は定格電圧の1.5倍

Please specify the capacitance tolerance code.

*1 Test Voltage of Loading at high temperature test is 1.5 time of the rated voltage.

■ 212TYPE(0805 case size) 4連タイプ(4 circuit type)

【温度特性 Temp.char. BJ:B/X5R】

定格電圧 Rated Voltage	形名 Ordering code		EHS (Environmental Hazardous Substances)	公称 静電容量 Capacitance [μF]	温度特性 Temperature characteristics	tan δ Dissipation factor [%] Max.	実装条件 Soldering method R:リフロー Reflow soldering W: フロー Wave soldering	静電容量 許容差 Capacitance tolerance	厚み Thickness [mm] (inch)
25V	T4K212 BJ104□D		RoHS	0.1	B/X5R	5	R	±10% [K] ±20% [M]	0.85±0.1 (0.033±0.004)
16V	E4K212 BJ104□D		RoHS	0.1	B/X5R*2				
10V	L4K212 BJ224□D		RoHS	0.22	B/X5R	10	R	±10% [K] ±20% [M]	0.85±0.1 (0.033±0.004)
	L4K212 BJ474□D		RoHS	0.47					
	L4K212 BJ105□D*1		RoHS	1	X5R				

形名の□には静電容量許容差記号が入ります。

*1 高温負荷試験の試験電圧は、定格電圧の1.5倍

*2 個別仕様の取扱いにより、X7R仕様に对应している場合があります。

Please specify the capacitance tolerance code.

*1 Test voltage of loading at high temperature test is 1.5 time of the rated voltage.

*2 We may provide X7R for some items according to the individual specification.

【温度特性 Temp.char. B7:X7R】

定格電圧 Rated Voltage	形名 Ordering code		EHS (Environmental Hazardous Substances)	公称 静電容量 Capacitance [μF]	温度特性 Temperature characteristics	tan δ Dissipation factor [%] Max.	実装条件 Soldering method R:リフロー Reflow soldering W: フロー Wave soldering	静電容量 許容差 Capacitance tolerance	厚み Thickness [mm] (inch)
16V	E4K212 B7104□D		RoHS	0.1	X7R	5	R	±10% [K] ±20% [M]	0.85±0.1 (0.033±0.004)

形名の□には静電容量許容差記号が入ります。

Please specify the capacitance tolerance code.

インピーダンス・ESR-周波数特性例 Example of Impedance ESR vs. Frequency characteristics
 ・ 当社積層セラミックコンデンサ例 (Taiyo Yuden multilayer ceramic capacitor)

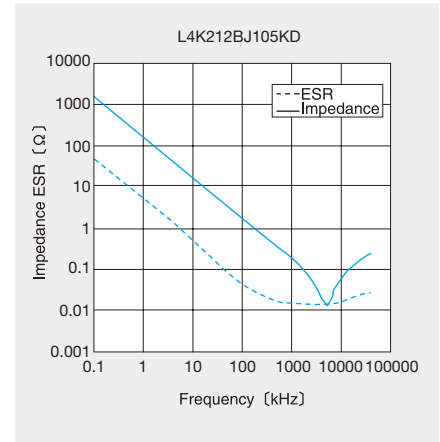
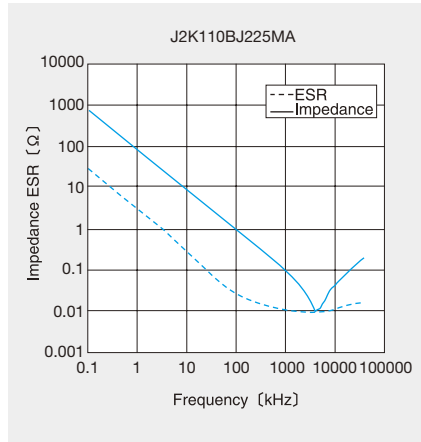
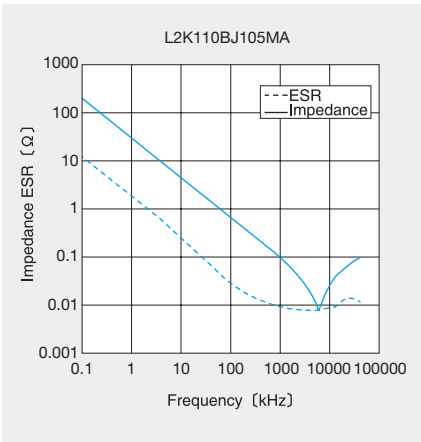
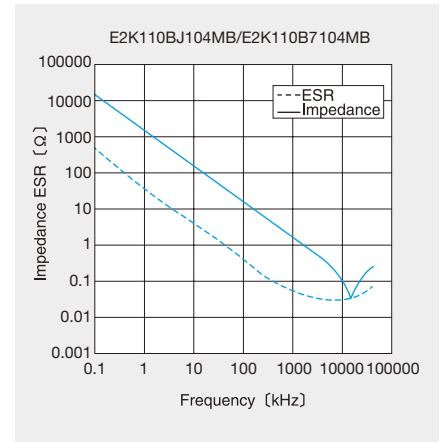
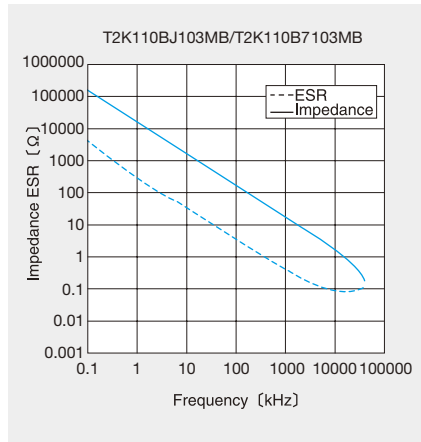
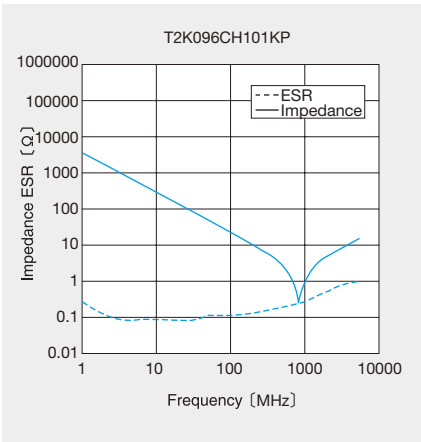
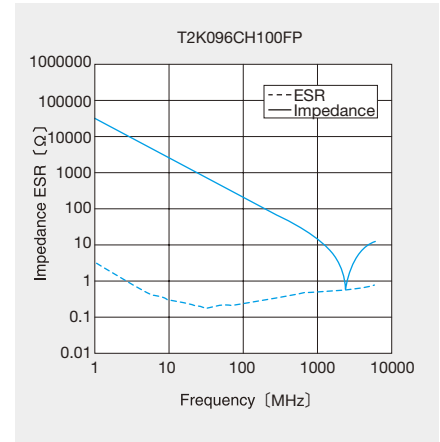
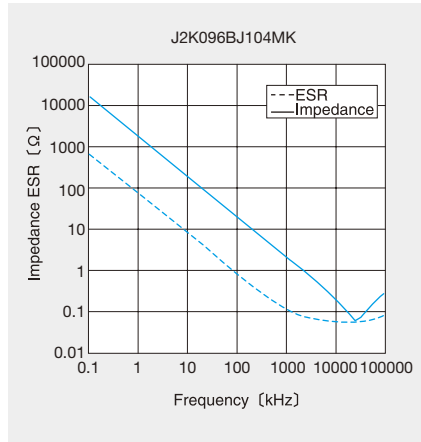
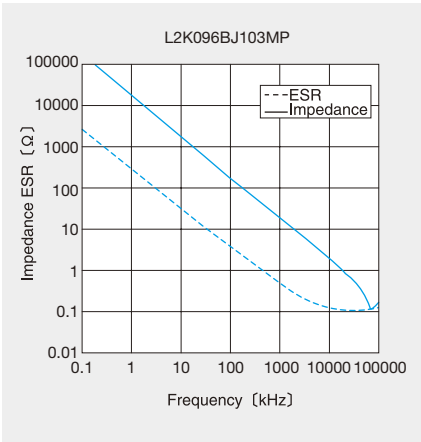

梱包 PACKAGING

①最小受注単位数 Minimum Quantity

■テーピング梱包 Taped packaging

形式 (EIA) Type	製品厚み Thickness		標準数量 Standard quantity [pcs]	
	mm (inch)	code	紙テープ paper	エンボステープ Embossed tape
□MK042(01005)	0.2 (0.008)	C	15000	—
□MK063(0201)	0.3 (0.012)	P	15000	—
□2K096(0302)	0.3 (0.012)	P	10000	—
	0.45 (0.018)	K		
□WK105(0204)	0.3 (0.012)	P	10000	—
□MK105(0402)	0.5 (0.020)	V, W	10000	—
		W		
□MK107(0603)	0.45 (0.018)	K	4000	—
		V		
□WK107(0306)	0.5 (0.020)	V	—	4000
		A		
□2K110(0504)	0.8 (0.031)	V	4000	—
		A		
□MK212(0805)	0.85 (0.033)	A	4000	—
		V		
□WK212(0508)	0.85 (0.033)	A	4000	—
		B		
□4K212(0805)	0.45 (0.018)	K	4000	—
		D		
□2K212(0805)	0.85 (0.033)	D	4000	—
		G		
□MK316(1206)	1.25 (0.049)	F	—	3000
		G		
		L		
□MK325(1210)	2.5 (0.098)	D	—	2000
		F		
		H		
		N		
		Y		
□MK432(1812)	2.5 (0.098)	M	—	500(T), 1000(P)
		M		

エンボステープ
Embossed Tape

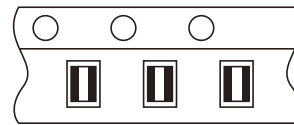
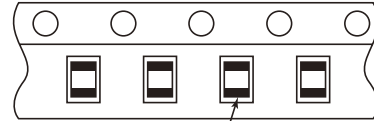
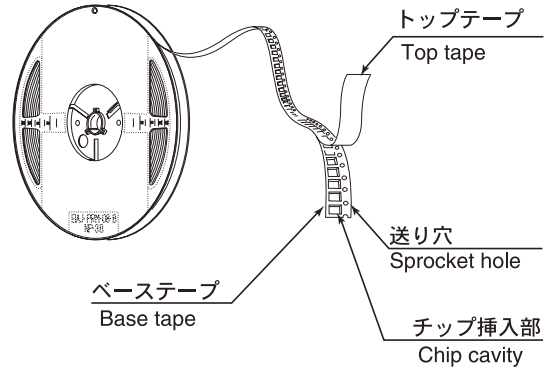

③バルクカセット Bulk Cassette

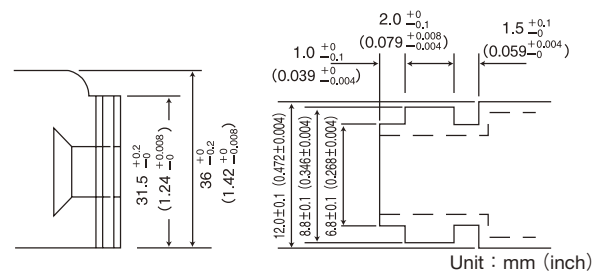
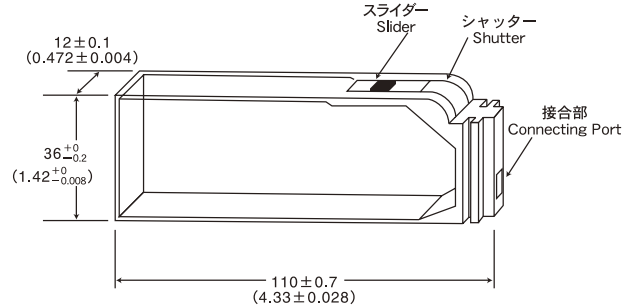

105, 107, 212形状で個別対応致しますのでお問い合わせ下さい。
Please contact any of our offices for accepting your requirement according to dimensions 0402, 0603, 0805.(inch)

②テーピング材質 Taping material

紙テープ
Card board carrier tape

※プレスポケットタイプは、
ボトムテープ無し。

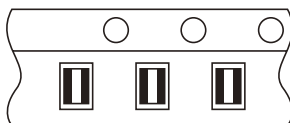
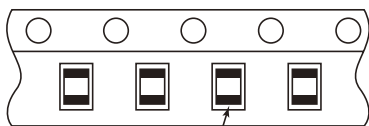
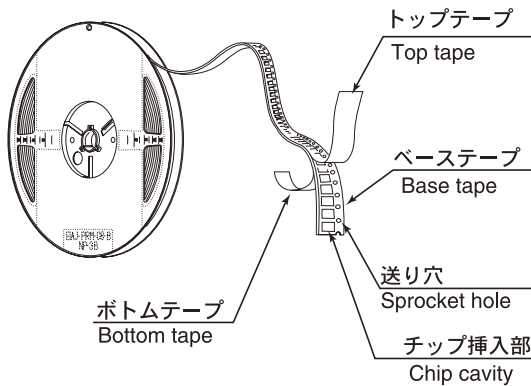

梱包 PACKAGING

③テーピング寸法 Taping dimensions
紙テープ Paper Tape (8mm幅) (0.315inches wide)

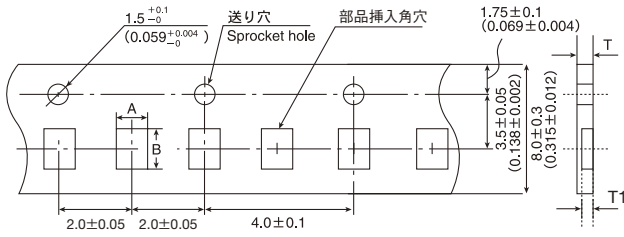

Type (EIA)	チップ挿入部 Chip Cavity		挿入ピッチ Insertion Pitch F	テープ厚み Tape Thickness	
	A	B		T	T1
□MK042 (01005)	0.25 (0.010)	0.45 (0.018)	2.0 ± 0.05 (0.079 ± 0.002)	0.36max. (0.014)	0.27max. (0.011)
□MK063 (0201)	0.37 (0.016)	0.67 (0.027)	2.0 ± 0.05 (0.079 ± 0.002)	0.45max. (0.018)	0.42max. (0.017)
□WK105 (0204)	0.65 (0.026)	1.15 (0.045)	2.0 ± 0.05 (0.079 ± 0.002)	0.45max. (0.018max)	0.42max. (0.017max)

Unit : mm (inch)

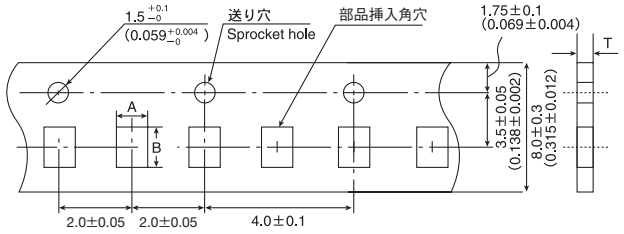

Type (EIA)	チップ挿入部 Chip Cavity		挿入ピッチ Insertion Pitch F	テープ厚み Tape Thickness T
	A	B		
□2K096 (0302)	0.72 (0.028)	1.02 (0.040)	2.0 ± 0.05 (0.079 ± 0.002)	0.45max.(0.018max) 0.6max.(0.024max)
□MK105 (0402)	0.65 (0.026)	1.15 (0.045)	2.0 ± 0.05 (0.079 ± 0.002)	0.8max. (0.031max.)
□VK105 (0402)	0.65 (0.026)	1.15 (0.045)	2.0 ± 0.05 (0.079 ± 0.002)	0.8max. (0.031max.)

Unit : mm (inch)

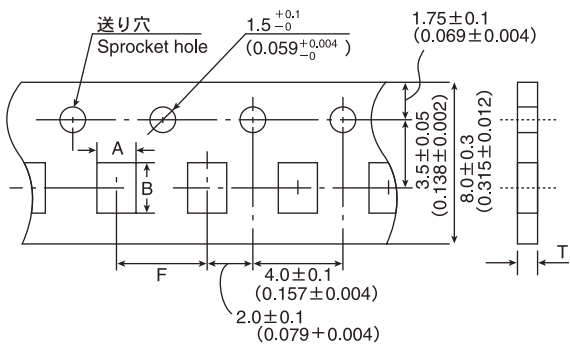

Type (EIA)	チップ挿入部 Chip Cavity		挿入ピッチ Insertion Pitch F	テープ厚み Tape Thickness T
	A	B		
□MK107 (0603)	1.0 (0.039)	1.8 (0.071)	4.0 ± 0.1 (0.157 ± 0.004)	1.1max. (0.043max.)
□WK107 (0306)	1.0 (0.039)	1.8 (0.071)	4.0 ± 0.1 (0.157 ± 0.004)	1.1max. (0.043max.)
□2K110 (0504)	1.15 (0.045)	1.55 (0.061)	4.0 ± 0.1 (0.157 ± 0.004)	1.0max. (0.039max.)
□MK212 (0805)	1.65 (0.065)	2.4 (0.094)	4.0 ± 0.1 (0.157 ± 0.004)	1.1max. (0.043max.)
□WK212 (0508)				
□4K212 (0805)				
□2K212 (0805)				
□MK316 (1206)	2.0 (0.079)	3.6 (0.142)	4.0 ± 0.1 (0.157 ± 0.004)	1.1max. (0.043max.)

Unit : mm (inch)

エンボステープ Embossed tape (8mm幅) (0.315inches wide)

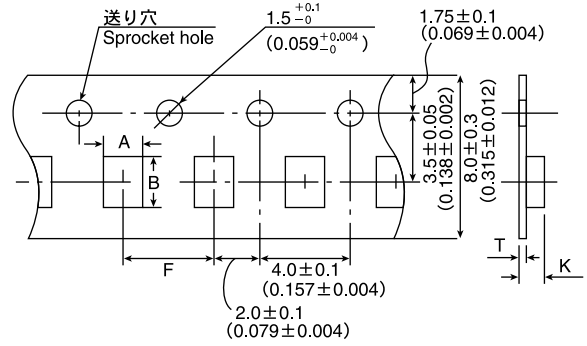

Type (EIA)	チップ挿入部 Chip cavity		挿入ピッチ Insertion Pitch F	テープ厚み Tape Thickness	
	A	B		K	T
□WK107 (0306)	1.0 (0.039)	1.8 (0.071)	4.0 ± 0.1 (0.157 ± 0.004)	1.3max. (0.051max.)	0.25 ± 0.1 (0.01 ± 0.004)
□MK212 (0805)	1.65 (0.065)	2.4 (0.094)		3.4max. (0.134max.)	0.6max. (0.024max.)
□MK316 (1206)	2.0 (0.079)	3.6 (0.142)	4.0 ± 0.1 (0.157 ± 0.004)	3.4max. (0.134max.)	0.6max. (0.024max.)
□MK325 (1210)	2.8 (0.110)	3.6 (0.142)		3.4max. (0.134max.)	0.6max. (0.024max.)

Unit : mm (inch)

エンボステープ Embossed tape (12mm幅) (0.472inches wide)

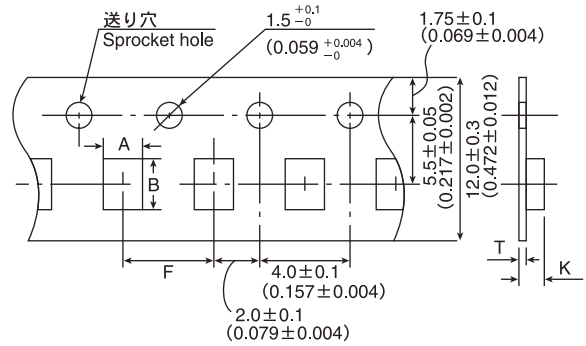

Type (EIA)	チップ挿入部 Chip cavity		挿入ピッチ Insertion Pitch F	テープ厚み Tape Thickness	
	A	B		K	T
□MK432 (1812)	3.7 (0.146)	4.9 (0.193)	8.0 ± 0.1 (0.315 ± 0.004)	4.0max. (0.157max.)	0.6max. (0.024max.)

Unit : mm (inch)

④リーダー部／空部 Leader and Blank portion

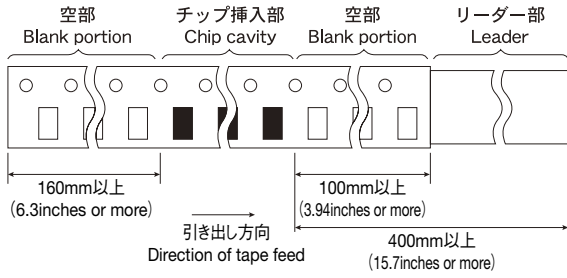

⑤リール寸法 Reel size

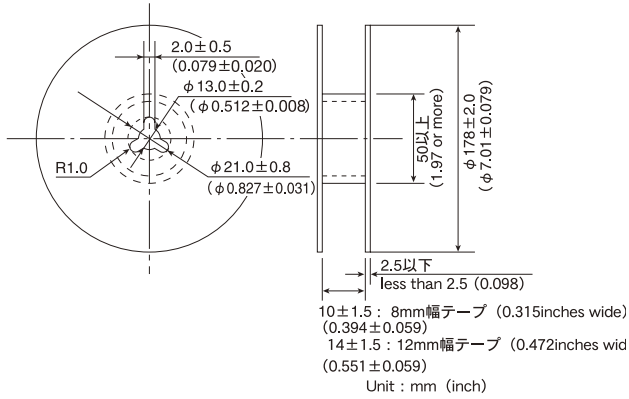

⑥トップテープ強度 Top Tape Strength

トップテープのはがし力は下図矢印方向にて0.1～0.7Nとなります。
The top tape requires a peel-off force of 0.1～0.7N in the direction of the arrow as illustrated below.

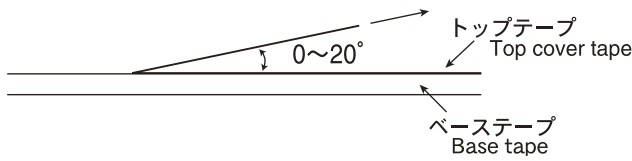

Multilayer Ceramic Capacitor Chips

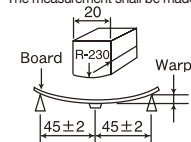
Item	Specified Value				Test Methods and Remarks
	Temperature Compensating (Class 1)		High Permittivity (Class 2)		
	Standard	High Frequency Type	Standard Note1	High Value	
1. Operating Temperature Range	-55 to +125°C		BJ : -55 to +125°C F : -25 to +85°C	-25 to +85°C	High Capacitance Type BJ (X7R) : -55~+125°C, BJ (X5R) : -55~+85°C E (Y5U) : -30~+85°C, F (Y5V) : -30~+85°C
2. Storage Temperature Range	-55 to +125°C		BJ : -55 to +125°C F : -25 to +85°C	-25 to +85°C	High Capacitance Type BJ (X7R) : -55~+125°C, BJ (X5R) : -55~+85°C E (Y5U) : -30~+85°C, F (Y5V) : -30~+85°C
3. Rated Voltage	50VDC, 25VDC, 16VDC	16VDC 50VDC	50VDC, 25VDC	50VDC, 35VDC, 25VDC 16VDC, 10VDC, 6.3VDC 4VDC, 2.5VDC	
4. Withstanding Voltage Between terminals	No breakdown or damage	No abnormality	No breakdown or damage		Applied voltage: Rated voltage × 3 (Class 1) Rated voltage × 2.5 (Class 2) Duration: 1 to 5 sec. Charge/discharge current: 50mA max. (Class 1,2)
5. Insulation Resistance	10000 MΩ min.		500 MΩ μF, or 10000 MΩ., whichever is the smaller. Note 5		Applied voltage: Rated voltage Duration: 60 ± 5 sec. Charge/discharge current: 50mA max.
6. Capacitance (Tolerance)	0.5 to 5 pF : ± 0.25 pF 1 to 10 pF : ± 0.5 pF 5 to 10 pF : ± 1 pF 11 pF or over : ± 5% ± 10% 105TYPE [△] , S [△] , T [△] , U [△] only 0.5~2pF : ± 0.1pF 2.2~20pF : ± 5%	0.5 to 2 pF : ± 0.1 pF 2.2 to 5.1 pF : ± 5%	BJ : ± 10%, ± 20% F : +80% -20%	BJ : ± 10%, ± 20% F : -20% / +80%	Measuring frequency : Class 1 : 1MHz ± 10% (C ≤ 1000pF) 1 k Hz ± 10% (C > 1000pF) Class 2 : 1 k Hz ± 10% (C ≤ 10 μF) 120Hz ± 10Hz (C > 10 μF) Measuring voltage : Note 4 Class 1 : 0.5~5Vrms (C ≤ 1000pF) 1 ± 0.2Vrms (C > 1000pF) Class 2 : 1 ± 0.2Vrms (C ≤ 10 μF) 0.5 ± 0.1Vrms (C > 10 μF) Bias application: None
7. Q or Tangent of Loss Angle (tan δ)	Under 30 pF : Q ≥ 400 + 20C 30 pF or over : Q ≥ 1000 C = Nominal capacitance	Refer to detailed specification	BJ : 2.5% max. (50V, 25V) F : 5.0% max. (50V, 25V) Note 4	BJ : 2.5% max. F : 7% max. Note 4	Multilayer: Measuring frequency : Class 1 : 1MHz ± 10% (C ≤ 1000pF) 1 k Hz ± 10% (C > 1000pF) Class 2 : 1 k Hz ± 10% (C ≤ 10 μF) 120Hz ± 10Hz (C > 10 μF) Measuring voltage : Note 4 Class 1 : 0.5~5Vrms (C ≤ 1000pF) 1 ± 0.2Vrms (C > 1000pF) Class 2 : 1 ± 0.2Vrms (C ≤ 10 μF) 0.5 ± 0.1Vrms (C > 10 μF) Bias application: None High-Frequency-Multilayer: Measuring frequency: 1GHz Measuring equipment: HP4291A Measuring jig: HP16192A
8. Temperature Characteristic of Capacitance	(Without voltage application) CK : 0 ± 250 CJ : 0 ± 120 CH : 0 ± 60 CG : 0 ± 30 RH : -220 ± 60 SK : -330 ± 250 SJ : -330 ± 120 SH : -330 ± 60 TK : -470 ± 250 TJ : -470 ± 120 UK : -750 ± 250 UJ : -750 ± 120 SL : +350 to -1000 (ppm/°C)	CH : 0 ± 60 RH : -220 ± 60 (ppm/°C)	BJ : ± 10% (-25~85°C) F : +30% (-25~85°C) -80 BJ (X7R) : ± 15% F (Y5V) : +22% -82	BJ : ± 10% (-25~+85°C) F : +30% / -80% (-25~+85°C) BJ (X7R, X5R) : ± 15% F (Y5V) : +22% / -82%	According to JIS C 5102 clause 7.12. Temperature compensating: Measurement of capacitance at 20°C and 85°C shall be made to calculate temperature characteristic by the following equation. $\frac{C_{85} - C_{20}}{C_{20} \times \Delta T} \times 10^6 \text{ (ppm/°C)}$ High permittivity: Change of maximum capacitance deviation in step 1 to 5 Temperature at step 1: +20°C Temperature at step 2: minimum operating temperature Temperature at step 3: +20°C (Reference temperature) Temperature at step 4: maximum operating temperature Temperature at step 5: +20°C Reference temperature for X7R, X5R, Y5U and Y5V shall be +25°C
9. Resistance to Flexure of Substrate	Appearance: No abnormality Capacitance change: Within ± 5% or ± 0.5 pF, whichever is larger.	Appearance: No abnormality Capacitance change: Within ± 0.5 pF	Appearance: No abnormality Capacitance change: BJ : Within ± 12.5% F : Within ± 30%		Warp: 1mm Testing board: glass epoxy-resin substrate Thickness: 1.6mm (063 TYPE : 0.8mm) The measurement shall be made with board in the bent position.  (Unit: mm)

Multilayer Ceramic Capacitor Chips

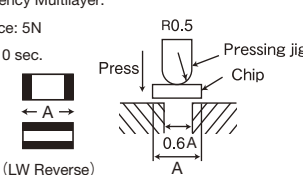
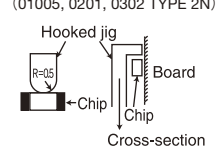
Item	Specified Value				Test Methods and Remarks
	Temperature Compensating (Class 1)		High Permittivity (Class 2)		
	Standard	High Frequency Type	Standard Note1	High Value	
10.Body Strength	—	No mechanical damage.	—	—	High Frequency Multilayer: Applied force: 5N Duration: 10 sec. 
11.Adhesion of Electrode	No separation or indication of separation of electrode.				Applied force: 5N Duration: 30±5 sec. (01005, 0201, 0302 TYPE 2N) 
12.Solderability	At least 95% of terminal electrode is covered by new solder.				Solder temperature: 230±5°C Duration: 4±1 sec.
13.Resistance to soldering	Appearance: No abnormality Capacitance change: Within ±2.5% or ±0.25pF, whichever is larger. Q: Initial value Insulation resistance: Initial value Withstanding voltage (between terminals): No abnormality	Appearance: No abnormality Capacitance change: Within ±2.5% Q: Initial value Insulation resistance: Initial value Withstanding voltage (between terminals): No abnormality	Appearance: No abnormality Capacitance change: Within ±7.5% (BJ) Within ±20% (F) tan δ: Initial value Note 4 Insulation resistance: Initial value Withstanding voltage (between terminals): No abnormality		Preconditioning: Thermal treatment (at 150°C for 1 hr) (Applicable to Class 2.) Solder temperature: 270±5°C Duration: 3±0.5 sec. Preheating conditions: 80 to 100°C, 2 to 5 min. or 5 to 10 min. 150 to 200°C, 2 to 5 min. or 5 to 10 min. Recovery: Recovery for the following period under the standard condition after the test. 6~24 hrs (Class 1) 24±2 hrs (Class 2)
14.Thermal shock	Appearance: No abnormality Capacitance change: Within ±2.5% or ±0.25pF, whichever is larger. Q: Initial value Insulation resistance: Initial value Withstanding voltage (between terminals): No abnormality	Appearance: No abnormality Capacitance change: Within ±0.25pF Q: Initial value Insulation resistance: Initial value Withstanding voltage (between terminals): No abnormality	Appearance: No abnormality Capacitance change: Within ±7.5% (BJ) Within ±20% (F) tan δ: Initial value Note 4 Insulation resistance: Initial value Withstanding voltage (between terminals): No abnormality		Preconditioning: Thermal treatment (at 150°C for 1 hr) (Applicable to Class 2.) Conditions for 1 cycle: Step 1: Minimum operating temperature $+0_{-3}^{\circ}\text{C}$ 30±3 min. Step 2: Room temperature 2 to 3 min. Step 3: Maximum operating temperature -0_{+3}°C 30±3 min. Step 4: Room temperature 2 to 3 min. Number of cycles: 5 times Recovery after the test: 6~24 hrs (Class 1) 24±2 hrs (Class 2)
15.Damp Heat (steady state)	Appearance: No abnormality Capacitance change: Within ±5% or ±0.5pF, whichever is larger. Q: $C \geq 30 \text{ pF} : Q \geq 350$ $10 \leq C < 30 \text{ pF} : Q \geq 275 + 2.5C$ $C < 10 \text{ pF} : Q \geq 200 + 10C$ C: Nominal capacitance Insulation resistance: 1000 MΩ min.	Appearance: No abnormality Capacitance change: Within ±0.5pF, Insulation resistance: 1000 MΩ min.	Appearance: No abnormality Capacitance change: BJ: Within ±12.5% F: Within ±30% tan δ: BJ: 5.0% max. F: 7.5% max. Note 4 Insulation resistance: 50 MΩμF or 1000 MΩ whichever is smaller. Note 5	Appearance: No abnormality Capacitance change: BJ: Within ±12.5% Note 4 tan δ: BJ: 5.0% max. Note 4. F: 11.0% max. Insulation resistance: 50 MΩμF or 1000 MΩ whichever is smaller. Note 5	Multilayer : Preconditioning: Thermal treatment (at 150°C for 1 hr) (Applicable to Class 2.) Temperature: 40±2°C Humidity: 90 to 95% RH Duration: 500 $+24_{-0}$ hrs Recovery: Recovery for the following period under the standard condition after the removal from test chamber. 6~24 hrs (Class 1) 24±2 hrs (Class 2) High-Frequency Multilayer: Temperature: 60±2°C Humidity: 90 to 95% RH Duration: 500 $+24_{-0}$ hrs Recovery: Recovery for the following period under the standard condition after the removal from test chamber. 6~24 hrs (Class 1)

Multilayer Ceramic Capacitor Chips

Item	Specified Value				Test Methods and Remarks
	Temperature Compensating (Class 1)		High Permittivity (Class 2)		
	Standard	High Frequency Type	Standard Note1	High Value	
16.Loading under Damp Heat	Appearance: No abnormality Capacitance change: Within $\pm 7.5\%$ or $\pm 0.75\text{pF}$, whichever is larger. Q: $C \geq 30\text{ pF}$: $Q \geq 200$ $C < 30\text{ pF}$: $Q \geq 100 + 10C/3$ C : Nominal capacitance Insulation resistance: 500 M Ω min.	Appearance: No abnormality Capacitance change: $C \leq 2\text{ pF}$: Within $\pm 0.4\text{ pF}$ $C > 2\text{ pF}$: Within $\pm 0.75\text{ pF}$ C : Nominal capacitance Insulation resistance: 500 M Ω min.	Appearance: No abnormality Capacitance change: BJ: Within $\pm 12.5\%$ F: Within $\pm 30\%$ Note 4 tan δ : BJ: 5.0% max. F: 7.5% max. Note 4 Insulation resistance: 25 M Ω μF or 500 M Ω , whichever is the smaller. Note 5	Appearance: No abnormality Capacitance change: BJ : Within $\pm 12.5\%$ F : Within $\pm 30\%$ Note 4 tan δ : BJ : 5.0% max. F : 11% max. Note 4 Insulation resistance: 25 M Ω μF or 500 M Ω , whichever is the smaller. Note 5	According to JIS C 5102 Clause 9. 9. Multilayer: Preconditioning: Voltage treatment (Class 2) Temperature: $40 \pm 2^\circ\text{C}$ Humidity: 90 to 95% RH Duration: 500^{+24}_0 hrs Applied voltage: Rated voltage Charge and discharge current: 50mA max. (Class 1,2) Recovery: Recovery for the following period under the standard condition after the removal from test chamber. 6~24 hrs (Class 1) 24 ± 2 hrs (Class 2) High-Frequency Multilayer: Temperature: $60 \pm 2^\circ\text{C}$ Humidity: 90 to 95% RH Duration: 500^{+24}_0 hrs Applied voltage: Rated voltage Charge and discharge current: 50mA max. Recovery: 6~24 hrs of recovery under the standard condition after the removal from test chamber.
17.Loading at High Temperature	Appearance: No abnormality Capacitance change: Within $\pm 3\%$ or $\pm 0.3\text{pF}$, whichever is larger. Q: $C \geq 30\text{ pF}$: $Q \geq 350$ $10 \leq C < 30\text{ pF}$: $Q \geq 275 + 2.5C$ $C < 10\text{ pF}$: $Q \geq 200 + 10C$ C : Nominal capacitance Insulation resistance: 1000 M Ω min.	Appearance: No abnormality Capacitance change: Within $\pm 3\%$ or $\pm 0.3\text{pF}$, whichever is larger. Insulation resistance: 1000 M Ω min.	Appearance: No abnormality Capacitance change: BJ: Within $\pm 12.5\%$ F: Within $\pm 30\%$ Note 4 tan δ : BJ: 4.0% max. F: 7.5% max. Note 4 Insulation resistance: 50 M Ω μF or 1000 M Ω , whichever is smaller. Note 5	Appearance: No abnormality Capacitance change: BJ : Within $\pm 12.5\%$ Within $\pm 20\% \text{ **}$ Within $\pm 25\% \text{ **}$ F : Within $\pm 30\%$ Note 4 tan δ : BJ : 5.0% max. F : 11% max. Note 4 Insulation resistance: 50 M Ω μF or 1000 M Ω , whichever is smaller. Note 5	According to JIS C 5102 clause 9.10. Multilayer: Preconditioning: Voltage treatment (Class 2) Temperature: $125 \pm 3^\circ\text{C}$ (Class 1, Class 2: B, BJ (X7R)) $85 \pm 2^\circ\text{C}$ (Class 2: BJ,F) Duration: 1000^{+48}_0 hrs Applied voltage: Rated voltage $\times 2$ Note 6 Recovery: Recovery for the following period under the standard condition after the removal from test chamber. 6~24 hrs (Class 1) 24 ± 2 hrs (Class 2) High-Frequency Multilayer: Temperature: $125 \pm 3^\circ\text{C}$ (Class 1) Duration: 1000^{+48}_0 hrs Applied voltage: Rated voltage $\times 2$ Recovery: 6~24 hrs of recovery under the standard condition after the removal from test chamber.

Note 1 :For 105 type, specified in "High value".

Note 2 :Thermal treatment (Multilayer): 1 hr of thermal treatment at $150 \pm 0 / -10^\circ\text{C}$ followed by 24 ± 2 hrs of recovery under the standard condition shall be performed before the measurement.

Note 3 :Voltage treatment (Multilayer): 1 hr of voltage treatment under the specified temperature and voltage for testing followed by 24 ± 2 hrs of recovery under the standard condition shall be performed before the measurement.

Note 4, 5 :The figure indicates typical inspection. Please refer to individual specifications.

Note 6 :Some of the parts are applicable in rated voltage $\times 1.5$. Please refer to individual specifications.





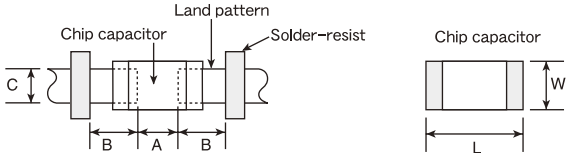
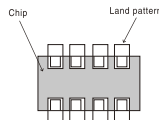

Note on standard condition: "standard condition" referred to herein is defined as follows: 5 to 35°C of temperature, 45 to 85% relative humidity, and 86 to 106kPa of air pressure.

When there are questions concerning measurement results: In order to provide correlation data, the test shall be conducted under condition of $20 \pm 2^\circ\text{C}$ of temperature, 60 to 70% relative humidity, and 86 to 106kPa of air pressure. Unless otherwise specified, all the tests are conducted under the "standard condition."

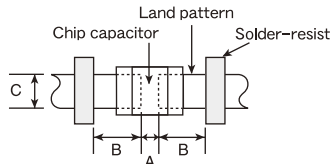
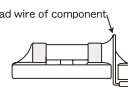
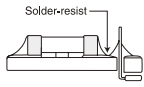
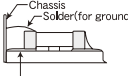
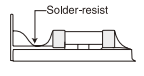
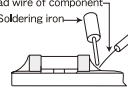
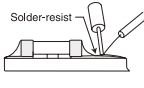
Precautions on the use of Multilayer Ceramic Capacitors

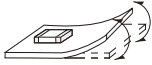
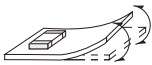
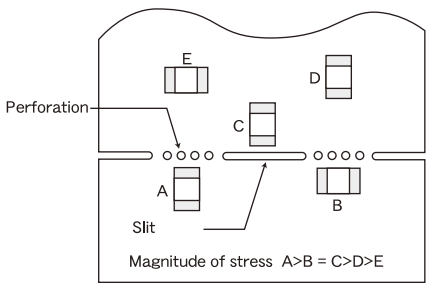
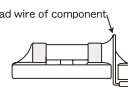
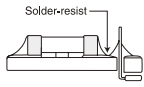
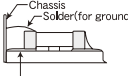
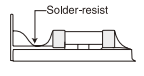
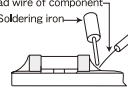
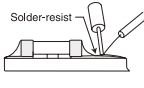
Stages	Precautions	Technical considerations																																																																																																																																		
1.Circuit Design	<p>Verification of operating environment, electrical rating and performance</p> <p>1. A malfunction in medical equipment, spacecraft, nuclear reactors, etc. may cause serious harm to human life or have severe social ramifications. As such, any capacitors to be used in such equipment may require higher safety and/or reliability considerations and should be clearly differentiated from components used in general purpose applications.</p> <p>Operating Voltage (Verification of Rated voltage)</p> <p>1. The operating voltage for capacitors must always be lower than their rated values.</p> <p>If an AC voltage is loaded on a DC voltage, the sum of the two peak voltages should be lower than the rated value of the capacitor chosen. For a circuit where both an AC and a pulse voltage may be present, the sum of their peak voltages should also be lower than the capacitor's rated voltage.</p> <p>2. Even if the applied voltage is lower than the rated value, the reliability of capacitors might be reduced if either a high frequency AC voltage or a pulse voltage having rapid rise time is present in the circuit.</p>																																																																																																																																			
2.PCB Design	<p>Pattern configurations (Design of Land-patterns)</p> <p>1. When capacitors are mounted on a PCB, the amount of solder used (size of fillet) can directly affect capacitor performance. Therefore, the following items must be carefully considered in the design of solder land patterns:</p> <p>(1) The amount of solder applied can affect the ability of chips to withstand mechanical stresses which may lead to breaking or cracking. Therefore, when designing land-patterns it is necessary to consider the appropriate size and configuration of the solder pads which in turn determines the amount of solder necessary to form the fillets.</p> <p>(2) When more than one part is jointly soldered onto the same land or pad, the pad must be designed so that each component's soldering point is separated by solder-resist.</p>	<p>1.The following diagrams and tables show some examples of recommended patterns to prevent excessive solder amounts. (larger fillets which extend above the component end terminations)</p> <p>Examples of improper pattern designs are also shown.</p> <p>(1) Recommended land dimensions for a typical chip capacitor land patterns for PCBs</p>  <p>Recommended land dimensions for wave-soldering (unit: mm)</p> <table border="1" data-bbox="853 1255 1228 1430"> <thead> <tr> <th>Type</th> <th>107</th> <th>212</th> <th>316</th> <th>325</th> </tr> </thead> <tbody> <tr> <td rowspan="2">Size</td> <td>L</td> <td>1.6</td> <td>2.0</td> <td>3.2</td> <td>3.2</td> </tr> <tr> <td>W</td> <td>0.8</td> <td>1.25</td> <td>1.6</td> <td>2.5</td> </tr> <tr> <td>A</td> <td>0.8~1.0</td> <td>1.0~1.4</td> <td>1.8~2.5</td> <td>1.8~2.5</td> </tr> <tr> <td>B</td> <td>0.5~0.8</td> <td>0.8~1.5</td> <td>0.8~1.7</td> <td>0.8~1.7</td> </tr> <tr> <td>C</td> <td>0.6~0.8</td> <td>0.9~1.2</td> <td>1.2~1.6</td> <td>1.8~2.5</td> </tr> </tbody> </table> <p>Recommended land dimensions for reflow-soldering (unit: mm)</p> <table border="1" data-bbox="845 1496 1452 1681"> <thead> <tr> <th>Type</th> <th>042</th> <th>063</th> <th>105</th> <th>107</th> <th>212</th> <th>316</th> <th>325</th> <th>432</th> </tr> </thead> <tbody> <tr> <td rowspan="2">Size</td> <td>L</td> <td>0.4</td> <td>0.6</td> <td>1.0</td> <td>1.6</td> <td>2.0</td> <td>3.2</td> <td>3.2</td> <td>4.5</td> </tr> <tr> <td>W</td> <td>0.2</td> <td>0.3</td> <td>0.5</td> <td>0.8</td> <td>1.25</td> <td>1.6</td> <td>2.5</td> <td>3.2</td> </tr> <tr> <td>A</td> <td>0.15~0.25</td> <td>0.20~0.30</td> <td>0.45~0.55</td> <td>0.8~1.0</td> <td>0.8~1.2</td> <td>1.8~2.5</td> <td>1.8~2.5</td> <td>2.5~3.5</td> </tr> <tr> <td>B</td> <td>0.10~0.20</td> <td>0.20~0.30</td> <td>0.40~0.50</td> <td>0.6~0.8</td> <td>0.8~1.2</td> <td>1.0~1.5</td> <td>1.0~1.5</td> <td>1.5~1.8</td> </tr> <tr> <td>C</td> <td>0.15~0.30</td> <td>0.25~0.40</td> <td>0.45~0.55</td> <td>0.6~0.8</td> <td>0.9~1.6</td> <td>1.2~2.0</td> <td>1.8~3.2</td> <td>2.3~3.5</td> </tr> </tbody> </table> <p>Excess solder can affect the ability of chips to withstand mechanical stresses. Therefore, please take proper precautions when designing land-patterns.</p> <table border="1" data-bbox="853 1758 997 1921"> <thead> <tr> <th>Type</th> <th>212 (4 circuits)</th> </tr> </thead> <tbody> <tr> <td rowspan="2">Size</td> <td>L</td> <td>2.0</td> </tr> <tr> <td>W</td> <td>1.25</td> </tr> <tr> <td>a</td> <td>0.5~0.6</td> </tr> <tr> <td>b</td> <td>0.5~0.6</td> </tr> <tr> <td>c</td> <td>0.2~0.3</td> </tr> <tr> <td>d</td> <td>0.5</td> </tr> </tbody> </table> <table border="1" data-bbox="853 1932 1189 2107"> <thead> <tr> <th>Type</th> <th>212 (2 circuits)</th> <th>110 (2 circuits)</th> <th>096 (2 circuits)</th> </tr> </thead> <tbody> <tr> <td rowspan="2">Size</td> <td>L</td> <td>2.0</td> <td>1.37</td> <td>0.9</td> </tr> <tr> <td>W</td> <td>1.25</td> <td>1.0</td> <td>0.6</td> </tr> <tr> <td>a</td> <td>0.5~0.6</td> <td>0.35~0.45</td> <td>0.25~0.35</td> </tr> <tr> <td>b</td> <td>0.5~0.6</td> <td>0.55~0.65</td> <td>0.15~0.25</td> </tr> <tr> <td>c</td> <td>0.5~0.6</td> <td>0.3~0.4</td> <td>0.15~0.25</td> </tr> <tr> <td>d</td> <td>1.0</td> <td>0.64</td> <td>0.45</td> </tr> </tbody> </table> 	Type	107	212	316	325	Size	L	1.6	2.0	3.2	3.2	W	0.8	1.25	1.6	2.5	A	0.8~1.0	1.0~1.4	1.8~2.5	1.8~2.5	B	0.5~0.8	0.8~1.5	0.8~1.7	0.8~1.7	C	0.6~0.8	0.9~1.2	1.2~1.6	1.8~2.5	Type	042	063	105	107	212	316	325	432	Size	L	0.4	0.6	1.0	1.6	2.0	3.2	3.2	4.5	W	0.2	0.3	0.5	0.8	1.25	1.6	2.5	3.2	A	0.15~0.25	0.20~0.30	0.45~0.55	0.8~1.0	0.8~1.2	1.8~2.5	1.8~2.5	2.5~3.5	B	0.10~0.20	0.20~0.30	0.40~0.50	0.6~0.8	0.8~1.2	1.0~1.5	1.0~1.5	1.5~1.8	C	0.15~0.30	0.25~0.40	0.45~0.55	0.6~0.8	0.9~1.6	1.2~2.0	1.8~3.2	2.3~3.5	Type	212 (4 circuits)	Size	L	2.0	W	1.25	a	0.5~0.6	b	0.5~0.6	c	0.2~0.3	d	0.5	Type	212 (2 circuits)	110 (2 circuits)	096 (2 circuits)	Size	L	2.0	1.37	0.9	W	1.25	1.0	0.6	a	0.5~0.6	0.35~0.45	0.25~0.35	b	0.5~0.6	0.55~0.65	0.15~0.25	c	0.5~0.6	0.3~0.4	0.15~0.25	d	1.0	0.64	0.45
Type	107	212	316	325																																																																																																																																
Size	L	1.6	2.0	3.2	3.2																																																																																																																															
	W	0.8	1.25	1.6	2.5																																																																																																																															
A	0.8~1.0	1.0~1.4	1.8~2.5	1.8~2.5																																																																																																																																
B	0.5~0.8	0.8~1.5	0.8~1.7	0.8~1.7																																																																																																																																
C	0.6~0.8	0.9~1.2	1.2~1.6	1.8~2.5																																																																																																																																
Type	042	063	105	107	212	316	325	432																																																																																																																												
Size	L	0.4	0.6	1.0	1.6	2.0	3.2	3.2	4.5																																																																																																																											
	W	0.2	0.3	0.5	0.8	1.25	1.6	2.5	3.2																																																																																																																											
A	0.15~0.25	0.20~0.30	0.45~0.55	0.8~1.0	0.8~1.2	1.8~2.5	1.8~2.5	2.5~3.5																																																																																																																												
B	0.10~0.20	0.20~0.30	0.40~0.50	0.6~0.8	0.8~1.2	1.0~1.5	1.0~1.5	1.5~1.8																																																																																																																												
C	0.15~0.30	0.25~0.40	0.45~0.55	0.6~0.8	0.9~1.6	1.2~2.0	1.8~3.2	2.3~3.5																																																																																																																												
Type	212 (4 circuits)																																																																																																																																			
Size	L	2.0																																																																																																																																		
	W	1.25																																																																																																																																		
a	0.5~0.6																																																																																																																																			
b	0.5~0.6																																																																																																																																			
c	0.2~0.3																																																																																																																																			
d	0.5																																																																																																																																			
Type	212 (2 circuits)	110 (2 circuits)	096 (2 circuits)																																																																																																																																	
Size	L	2.0	1.37	0.9																																																																																																																																
	W	1.25	1.0	0.6																																																																																																																																
a	0.5~0.6	0.35~0.45	0.25~0.35																																																																																																																																	
b	0.5~0.6	0.55~0.65	0.15~0.25																																																																																																																																	
c	0.5~0.6	0.3~0.4	0.15~0.25																																																																																																																																	
d	1.0	0.64	0.45																																																																																																																																	

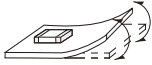
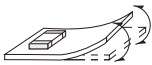
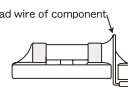
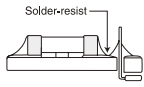
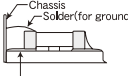
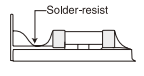
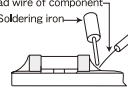
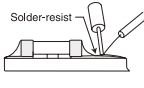
Precautions on the use of Multilayer Ceramic Capacitors

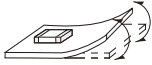
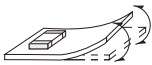
Stages	Precautions	Technical considerations																																														
<p>2.PCB Design</p>	<p>Pattern configurations (Capacitor layout on panelized [breakaway] PC boards)</p> <p>1. After capacitors have been mounted on the boards, chips can be subjected to mechanical stresses in subsequent manufacturing processes (PCB cutting, board inspection, mounting of additional parts, assembly into the chassis, wave soldering the reflow soldered boards etc.) For this reason, planning pattern configurations and the position of SMD capacitors should be carefully performed to minimize stress.</p>	<p>LWDC Recommended land dimensions for reflow-soldering</p>  <table border="1" data-bbox="853 469 1157 655"> <thead> <tr> <th>Type</th> <th>105</th> <th>107</th> <th>212</th> </tr> </thead> <tbody> <tr> <td rowspan="2">Size</td> <td>L</td> <td>0.52</td> <td>0.8</td> <td>1.25</td> </tr> <tr> <td>W</td> <td>1.0</td> <td>1.6</td> <td>2.0</td> </tr> <tr> <td>A</td> <td>0.18~0.22</td> <td>0.25~0.3</td> <td>0.5~0.7</td> </tr> <tr> <td>B</td> <td>0.2~0.25</td> <td>0.3~0.4</td> <td>0.4~0.5</td> </tr> <tr> <td>C</td> <td>0.9~1.1</td> <td>1.5~1.7</td> <td>1.9~2.1</td> </tr> </tbody> </table> <p>(unit: mm)</p> <p>(2) Examples of good and bad solder application</p> <table border="1" data-bbox="845 753 1444 1190"> <thead> <tr> <th>Items</th> <th>Not recommended</th> <th>Recommended</th> </tr> </thead> <tbody> <tr> <td>Mixed mounting of SMD and leaded components</td> <td></td> <td></td> </tr> <tr> <td>Component placement close to the chassis</td> <td></td> <td></td> </tr> <tr> <td>Hand-soldering of leaded components near mounted components</td> <td></td> <td></td> </tr> <tr> <td>Horizontal component placement</td> <td></td> <td></td> </tr> </tbody> </table> <p>1-1. The following are examples of good and bad capacitor layout; SMD capacitors should be located to minimize any possible mechanical stresses from board warp or deflection.</p> <table border="1" data-bbox="845 1299 1444 1452"> <thead> <tr> <th></th> <th>Not recommended</th> <th>Recommended</th> </tr> </thead> <tbody> <tr> <td>Deflection of the board</td> <td></td> <td></td> </tr> </tbody> </table> <p>1-2. To layout the capacitors for the breakaway PC board, it should be noted that the amount of mechanical stresses given will vary depending on capacitor layout. The example below shows recommendations for better design.</p>  <p>1-3. When breaking PC boards along their perforations, the amount of mechanical stress on the capacitors can vary according to the method used. The following methods are listed in order from least stressful to most stressful: push-back, slit, V-grooving, and perforation. Thus, any ideal SMD capacitor layout must also consider the PCB splitting procedure.</p>	Type	105	107	212	Size	L	0.52	0.8	1.25	W	1.0	1.6	2.0	A	0.18~0.22	0.25~0.3	0.5~0.7	B	0.2~0.25	0.3~0.4	0.4~0.5	C	0.9~1.1	1.5~1.7	1.9~2.1	Items	Not recommended	Recommended	Mixed mounting of SMD and leaded components			Component placement close to the chassis			Hand-soldering of leaded components near mounted components			Horizontal component placement				Not recommended	Recommended	Deflection of the board		
Type	105	107	212																																													
Size	L	0.52	0.8	1.25																																												
	W	1.0	1.6	2.0																																												
A	0.18~0.22	0.25~0.3	0.5~0.7																																													
B	0.2~0.25	0.3~0.4	0.4~0.5																																													
C	0.9~1.1	1.5~1.7	1.9~2.1																																													
Items	Not recommended	Recommended																																														
Mixed mounting of SMD and leaded components																																																
Component placement close to the chassis																																																
Hand-soldering of leaded components near mounted components																																																
Horizontal component placement																																																
	Not recommended	Recommended																																														
Deflection of the board																																																

Precautions on the use of Multilayer Ceramic Capacitors

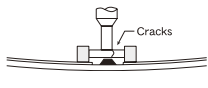
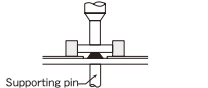
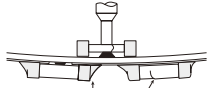
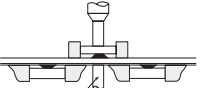
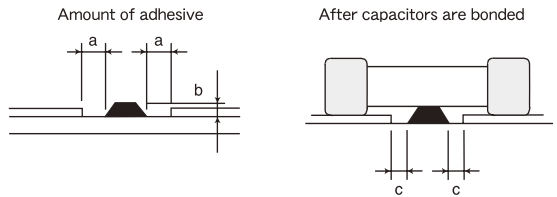
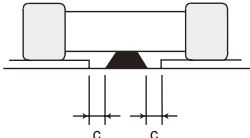
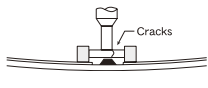
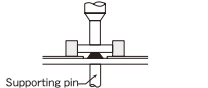
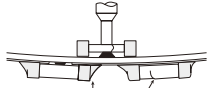
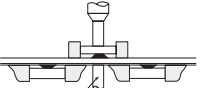
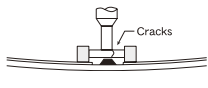
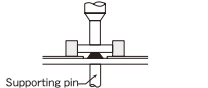
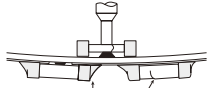
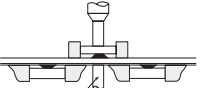
Stages	Precautions	Technical considerations																	
<p>3.Considerations for auto-automatic placement</p>	<p>Adjustment of mounting machine</p> <ol style="list-style-type: none"> Excessive impact load should not be imposed on the capacitors when mounting onto the PC boards. The maintenance and inspection of the mounters should be conducted periodically. <p>Selection of Adhesives</p> <ol style="list-style-type: none"> Mounting capacitors with adhesives in preliminary assembly, before the soldering stage, may lead to degraded capacitor characteristics unless the following factors are appropriately checked; the size of land patterns, type of adhesive, amount applied, hardening temperature and hardening period. Therefore, it is imperative to consult the manufacturer of the adhesives on proper usage and amounts of adhesive to use. 	<ol style="list-style-type: none"> If the lower limit of the pick-up nozzle is low, too much force may be imposed on the capacitors, causing damage. To avoid this, the following points should be considered before lowering the pick-up nozzle: <ol style="list-style-type: none"> The lower limit of the pick-up nozzle should be adjusted to the surface level of the PC board after correcting for deflection of the board. The pick-up pressure should be adjusted between 1 and 3 N static loads. To reduce the amount of deflection of the board caused by impact of the pick-up nozzle, supporting pins or back-up pins should be used under the PC board. The following diagrams show some typical examples of good pick-up nozzle placement: <table border="1" data-bbox="849 526 1449 794"> <thead> <tr> <th></th> <th>Not recommended</th> <th>Recommended</th> </tr> </thead> <tbody> <tr> <td>Single-sided mounting</td> <td></td> <td></td> </tr> <tr> <td>Double-sided mounting</td> <td></td> <td></td> </tr> </tbody> </table> <ol style="list-style-type: none"> As the alignment pin wears out, adjustment of the nozzle height can cause chipping or cracking of the capacitors because of mechanical impact on the capacitors. To avoid this, the monitoring of the width between the alignment pin in the stopped position, and maintenance, inspection and replacement of the pin should be conducted periodically. <ol style="list-style-type: none"> Some adhesives may cause reduced insulation resistance. The difference between the shrinkage percentage of the adhesive and that of the capacitors may result in stresses on the capacitors and lead to cracking. Moreover, too little or too much adhesive applied to the board may adversely affect component placement, so the following precautions should be noted in the application of adhesives. <ol style="list-style-type: none"> Required adhesive characteristics <ol style="list-style-type: none"> The adhesive should be strong enough to hold parts on the board during the mounting & solder process. The adhesive should have sufficient strength at high temperatures. The adhesive should have good coating and thickness consistency. The adhesive should be used during its prescribed shelf life. The adhesive should harden rapidly The adhesive must not be contaminated. The adhesive should have excellent insulation characteristics. The adhesive should not be toxic and have no emission of toxic gasses. The recommended amount of adhesives is as follows; <table border="1" data-bbox="852 1469 1402 1589"> <thead> <tr> <th>Figure</th> <th>212/316 case sizes as examples</th> </tr> </thead> <tbody> <tr> <td>a</td> <td>0.3mm min</td> </tr> <tr> <td>b</td> <td>100 ~ 120 μm</td> </tr> <tr> <td>c</td> <td>Adhesives should not contact the pad</td> </tr> </tbody> </table> <div style="display: flex; justify-content: space-around; margin-top: 20px;"> <div data-bbox="874 1662 1109 1808"> <p>Amount of adhesive</p>  </div> <div data-bbox="1173 1662 1423 1852"> <p>After capacitors are bonded</p>  </div> </div>		Not recommended	Recommended	Single-sided mounting			Double-sided mounting			Figure	212/316 case sizes as examples	a	0.3mm min	b	100 ~ 120 μm	c	Adhesives should not contact the pad
	Not recommended	Recommended																	
Single-sided mounting																			
Double-sided mounting																			
Figure	212/316 case sizes as examples																		
a	0.3mm min																		
b	100 ~ 120 μm																		
c	Adhesives should not contact the pad																		

Precautions on the use of Multilayer Ceramic Capacitors

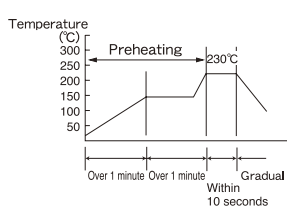
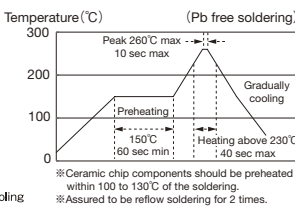
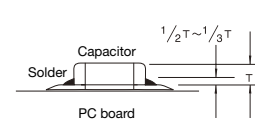
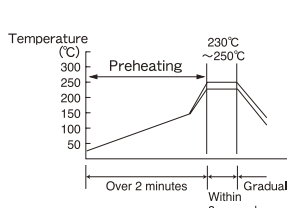
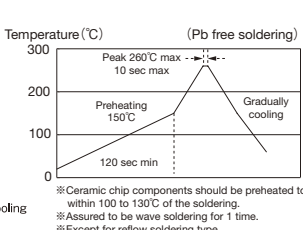
Stages	Precautions	Technical considerations
4. Soldering	<p>Selection of Flux</p> <p>1. Since flux may have a significant effect on the performance of capacitors, it is necessary to verify the following conditions prior to use;</p> <p>(1) Flux used should be with less than or equal to 0.1 wt% (equivalent to chlorine) of halogenated content. Flux having a strong acidity content should not be applied.</p> <p>(2) When soldering capacitors on the board, the amount of flux applied should be controlled at the optimum level.</p> <p>(3) When using water-soluble flux, special care should be taken to properly clean the boards.</p> <p>Soldering</p> <p>Temperature, time, amount of solder, etc. are specified in accordance with the following recommended conditions.</p> <p>Sn-Zn solder paste can affect MLCC reliability performance. Please contact us prior to usage.</p>	<p>1-1. When too much halogenated substance (Chlorine, etc.) content is used to activate the flux, or highly acidic flux is used, an excessive amount of residue after soldering may lead to corrosion of the terminal electrodes or degradation of insulation resistance on the surface of the capacitors.</p> <p>1-2. Flux is used to increase solderability in flow soldering, but if too much is applied, a large amount of flux gas may be emitted and may detrimentally affect solderability. To minimize the amount of flux applied, it is recommended to use a flux-bubbling system.</p> <p>1-3. Since the residue of water-soluble flux is easily dissolved by water content in the air, the residue on the surface of capacitors in high humidity conditions may cause a degradation of insulation resistance and therefore affect the reliability of the components. The cleaning methods and the capability of the machines used should also be considered carefully when selecting water-soluble flux.</p> <p>1-1. Preheating when soldering</p> <p>Heating: Ceramic chip components should be preheated to within 100 to 130°C of the soldering.</p> <p>Cooling: The temperature difference between the components and cleaning process should not be greater than 100°C.</p> <p>Ceramic chip capacitors are susceptible to thermal shock when exposed to rapid or concentrated heating or rapid cooling. Therefore, the soldering process must be conducted with great care so as to prevent malfunction of the components due to excessive thermal shock.</p> <p>Recommended conditions for soldering</p> <p>[Reflow soldering]</p> <p>Temperature profile</p>   <p>Caution</p> <p>1. The ideal condition is to have solder mass (fillet) controlled to 1/2 to 1/3 of the thickness of the capacitor, as shown below:</p>  <p>2. Because excessive dwell times can detrimentally affect solderability, soldering duration should be kept as close to recommended times as possible.</p> <p>[Wave soldering]</p> <p>Temperature profile</p>   <p>Caution</p> <p>1. Make sure the capacitors are preheated sufficiently.</p> <p>2. The temperature difference between the capacitor and melted solder should not be greater than 100 to 130°C</p> <p>3. Cooling after soldering should be as gradual as possible.</p> <p>4. Wave soldering must not be applied to the capacitors designated as for reflow soldering only.</p>

Precautions on the use of Multilayer Ceramic Capacitors

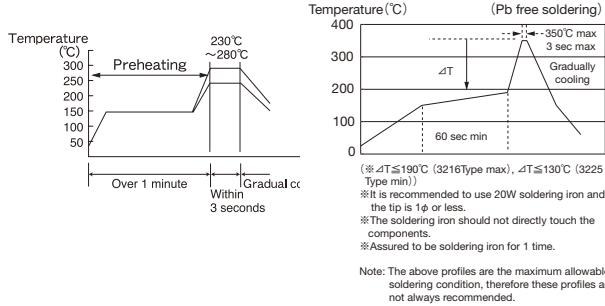
Stages	Precautions	Technical considerations
4. Soldering		<p>[Hand soldering]</p> <p>Temperature profile</p>  <p>Caution</p> <ol style="list-style-type: none"> 1. Use a 20W soldering iron with a maximum tip diameter of 1.0 mm. 2. The soldering iron should not directly touch the capacitor.
5. Cleaning	<p>Cleaning conditions</p> <ol style="list-style-type: none"> 1. When cleaning the PC board after the capacitors are all mounted, select the appropriate cleaning solution according to the type of flux used and purpose of the cleaning (e.g. to remove soldering flux or other materials from the production process.) 2. Cleaning conditions should be determined after verifying, through a test run, that the cleaning process does not affect the capacitor's characteristics. 	<ol style="list-style-type: none"> 1. The use of inappropriate solutions can cause foreign substances such as flux residue to adhere to the capacitor or deteriorate the capacitor's outer coating, resulting in a degradation of the capacitor's electrical properties (especially insulation resistance). 2. Inappropriate cleaning conditions (insufficient or excessive cleaning) may detrimentally affect the performance of the capacitors. <p>(1) Excessive cleaning</p> <p>In the case of ultrasonic cleaning, too much power output can cause excessive vibration of the PC board which may lead to the cracking of the capacitor or the soldered portion, or decrease the terminal electrodes' strength. Thus the following conditions should be carefully checked;</p> <p>Ultrasonic output Below 20 W/ℓ Ultrasonic frequency Below 40 kHz Ultrasonic washing period 5 min. or less</p>
6. Post cleaning processes	<ol style="list-style-type: none"> 1. With some type of resins a decomposition gas or chemical reaction vapor may remain inside the resin during the hardening period or while left under normal storage conditions resulting in the deterioration of the capacitor's performance. 2. When a resin's hardening temperature is higher than the capacitor's operating temperature, the stresses generated by the excess heat may lead to capacitor damage or destruction. The use of such resins, molding materials etc. is not recommended. 	
7. Handling	<p>Breakaway PC boards (splitting along perforations)</p> <ol style="list-style-type: none"> 1. When splitting the PC board after mounting capacitors and other components, care is required so as not to give any stresses of deflection or twisting to the board. 2. Board separation should not be done manually, but by using the appropriate devices. <p>Mechanical considerations</p> <ol style="list-style-type: none"> 1. Be careful not to subject the capacitors to excessive mechanical shocks. <ol style="list-style-type: none"> (1) If ceramic capacitors are dropped onto the floor or a hard surface, they should not be used. (2) When handling the mounted boards, be careful that the mounted components do not come in contact with or bump against other boards or components. 	

Precautions on the use of Multilayer Ceramic Capacitors

Stages	Precautions	Technical considerations
8.Storage conditions	<p>Storage</p> <p>1. To maintain the solderability of terminal electrodes and to keep the packaging material in good condition, care must be taken to control temperature and humidity in the storage area. Humidity should especially be kept as low as possible.</p> <ul style="list-style-type: none"> • Recommended conditions <ul style="list-style-type: none"> Ambient temperature Below 30°C Humidity Below 70% RH <p>The ambient temperature must be kept below 40°C. Even under ideal storage conditions capacitor electrode solderability decreases as time passes, so should be used within 6 months from the time of delivery.</p> <ul style="list-style-type: none"> • Ceramic chip capacitors should be kept where no chlorine or sulfur exists in the air. <p>2. The capacitance value of high dielectric constant capacitors (type 2 &3) will gradually decrease with the passage of time, so this should be taken into consideration in the circuit design. If such a capacitance reduction occurs, a heat treatment of 150°C for 1hour will return the capacitance to its initial level.</p>	<p>1. If the parts are stored in a high temperature and humidity environment, problems such as reduced solderability caused by oxidation of terminal electrodes and deterioration of taping/package materials may take place. For this reason, components should be used within 6 months from the time of delivery. If exceeding the above period, please check solderability before using the capacitors.</p>

X-ON Electronics

Largest Supplier of Electrical and Electronic Components

Click to view similar products for [Multilayer Ceramic Capacitors MLCC - SMD/SMT category:](#)

Click to view products by [Taiyo Yuden manufacturer:](#)

Other Similar products are found below :

[M39014/01-1467](#) [M39014/02-1218V](#) [M39014/02-1225V](#) [M39014/02-1262V](#) [M39014/02-1301](#) [M39014/22-0631](#) [1210J5000102JCT](#)
[1210J2K00102KXT](#) [1210J5000103KXT](#) [1210J5000223KXT](#) [D55342E07B379BR-TR](#) [D55342E07B523DR-T/R](#) [1812J1K00103KXT](#)
[1812J1K00473KXT](#) [1812J2K00680JCT](#) [1812J4K00102MXT](#) [1812J5000102JCT](#) [1812J5000103JCT](#) [1812J5000682JCT](#) [NIN-FB391JTRF](#)
[NIN-FC2R7JTRF](#) [NPIS27H102MTRF](#) [C1206C101J1GAC](#) [C1608C0G1E472JT000N](#) [C2012C0G2A472J](#) [2220J2K00101JCT](#)
[KHC201E225M76N0T00](#) [LRC-LRF1206LF-01R025FTR1K](#) [1812J1K00222JCT](#) [1812J2K00102KXT](#) [1812J2K00222KXT](#)
[1812J2K00472KXT](#) [2-1622820-7-CUT-TAPE](#) [2220J3K00102KXT](#) [2225J2500824KXT](#) [CCR07CG103KM](#) [CGA2B2C0G1H010C](#)
[CGA2B2C0G1H040C](#) [CGA2B2C0G1H050C](#) [CGA2B2C0G1H060D](#) [CGA2B2C0G1H070D](#) [CGA2B2C0G1H151J](#) [CGA2B2C0G1H1R5C](#)
[CGA2B2C0G1H2R2C](#) [CGA2B2C0G1H3R3C](#) [CGA2B2C0G1H680J](#) [CGA2B2C0G1H6R8D](#) [CGA2B2X8R1H221K](#) [CGA2B2X8R1H472K](#)
[CGA3E1X7R1C474K](#)