

Electromechanical and solid-state Zelio[®] Relays

Catalog
2010





Reduce the size of your enclosures and, at the same time, increase machine reliability...



with these new Zelio® Relays

> Electromechanical relays RSL

Only 6 mm wide, thus saving considerable space in your enclosures



6 mm wide

> Solid-state relays SSR

Enhanced service life provided by electronic technology



Enhanced service life

Contents

Introduction

Save Space with Zelio Relay RSL	4-5
Choose long life and silent operation with Zelio Relay SSR	6-7
Electromechanical and solid-state relays panorama	8-9

Technical characteristics

Zelio Relay RSL	12-17
Zelio Relay RSB, RXM, RUM, RPM	18-49
Zelio Relay ABR, ABS	54-73
Zelio Relay SSR	74-81

Make the most of your energySM



Save space with Zelio[®] Relay RSL

Only 6 mm wide

reduces the size of your enclosure

> A solution for any application

A versatile offer

- > An offer with maximum flexibility, comprising:
 - complete products: a single reference for a relay mounted on a socket,
- > Wide choice of sockets available covering a range of voltages from 12 to 230 V.
 - select the relay and associated socket according to your application.

An offer that meets the most demanding standards

- Conformity with the European RoHS (Restriction of Hazardous Substances) directive.
- Conformity to international standards IEC/EN 61810-1, UL508, CSA C22.2 N°14, GOST.

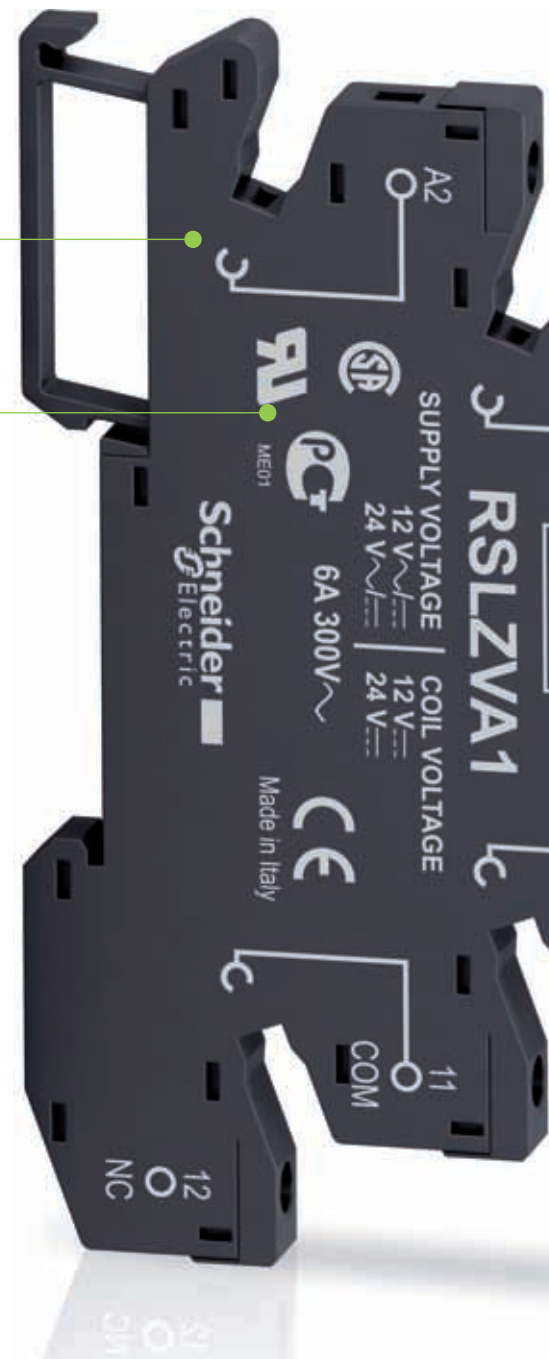

100% RoHS

Schneider Electric commits itself to reducing the environmental impact of its products

> Increased reliability in operation

Added protection in the socket

Built-in protection from transients and reverse polarity voltages.

LED indicator

Power on and relay status indication.



Standard 1 C/O relays

For general purpose load requirements.

Up to **6A** switching

> Simple installation and maintenance

Simple maintenance of relay in socket
Using locking/unlocking lever.

Simple wiring

Bus jumpers available as accessories.

Simple mounting on DIN rail

2 connection choices

Suitable for the majority of your applications.



Screw connector



Spring terminal

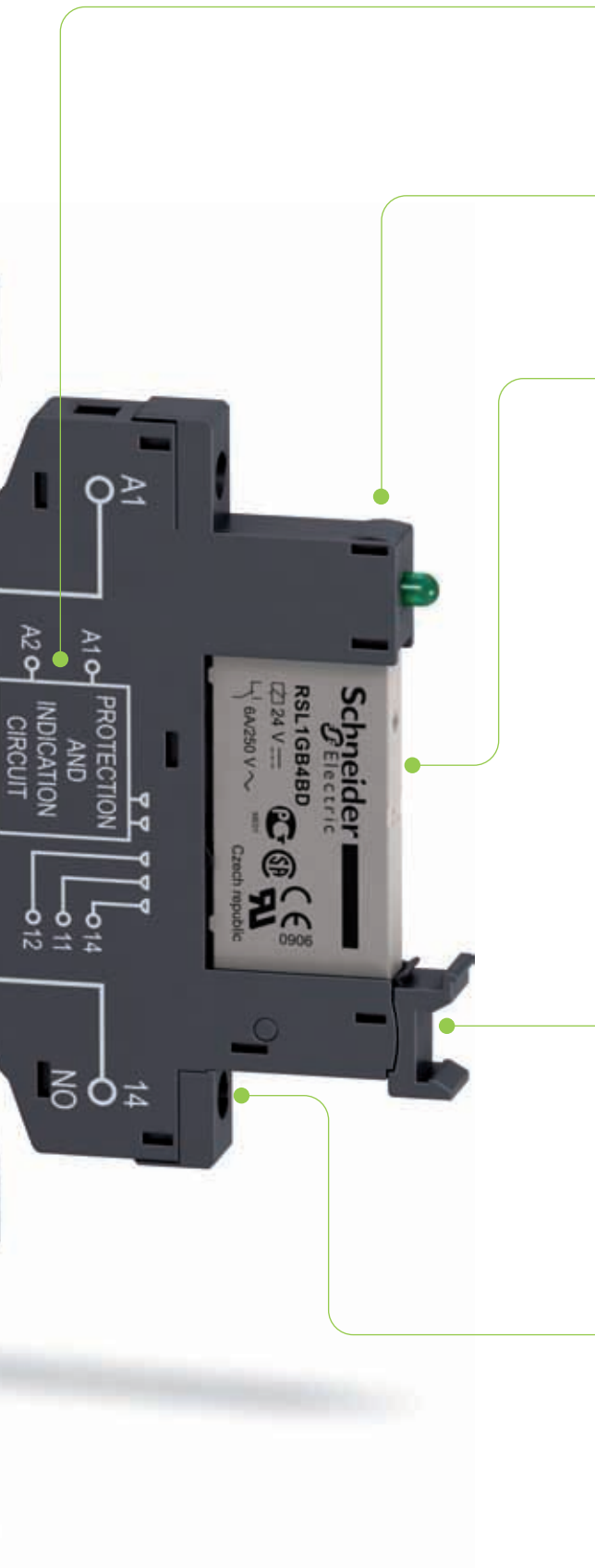

Choose long life and silent operation with Zelio[®] SSR Relays

> Optimized heat exchange

The new solid-state relays SSR with SCR (Semiconductor Controlled Rectifier) outputs offer you two alternatives:

SSRD range

Integrated heat sink to provide factory tested heat exchange, that easily mounts by clipping directly onto DIN rail. Can also be panel mounted.

SSRP range

Panel mounted, either by itself or combined with a heat sink for applications requiring considerable heat exchange.

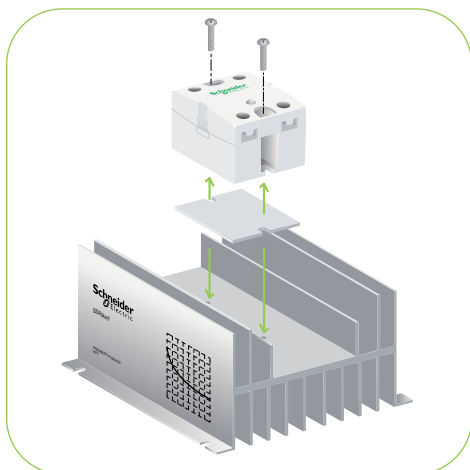

SSRP relay mounted on heat sink with thermal transfer pad



> Distinctive indication

A green LED on the front face of the products provides instant indication of the presence of input voltage.



> High performance

High breaking capacities

- From 10 to 125 A for relays SSRP
- From 10 to 45 A for relays SSRD

Wide supply voltage range

- From 3 to 32 VDC and 90 to 280 VAC

Outputs suited to applications

- From 24 to 280 VAC and 48 to 530/660 VAC

Space Saving SSRD series

- Only 22.5 mm and up to 45.5 mm wide

Enhanced service life

- Reduced preventive maintenance. SSR relays have little to no maintenance required once applied correctly.

Silence of electronic technology

- Complete silence when switching

Vibration resistant

- Even in the event of excessive vibration, the relay will not change state

Enhanced service life

due to electronic relay technology

Complete silence when switching

providing suitability for building and hospital applications

High switching frequency

particularly on packaging and textile machines

> Conformity to international standards

**100%
RoHS**

Schneider Electric commits itself to reducing the environmental impact of its products

Panorama Zelio® Relays

Electromechanical relays



Contact configuration	1 C/O	1 or 2 C/O	1 or 2 C/O	2, 3 or 4 C/O
Current	6 A	8-12-16 A	5-12 A	6-10-12 A
Mounting	DIN rail		DIN rail	DIN rail or panel
Catalog numbers	RSL	RSB	ABR	RXM
Pages	12 to 17	20 to 23	54 to 73	24 to 31

Electromechanical relay advantages

- Wide number of contacts (up to 4)
- Easy installation and maintenance
- Socket compatible plug in relays
- Flag indicator to show contact status
- Lockable test button for checking circuit during build
- Magnetically isolated
- Coil voltage LED indicator

Electromechanical relays

Solid-state relays



2, 3 or 4 C/O

1, 2, 3 or 4 C/O

2 C/O or 2 N/O

1 N/O

1 N/O

1 N/O

10 A

15 A

30 A

3 A

10 ...45 A

10 ...125 A

DIN rail or panel

DIN rail

DIN rail or panel

Panel

RUM

RPM

RPF

ABS

SSRD

SSRP

32 to 41

42 to 49

50 to 53

54 to 73

74 to 81

74 to 81

Solid-state relay (SSR) advantages

- Enhanced service life
- Wide supply voltage range and high breaking current (up to 125 A), suited to packaging and textile machines
- Input power indicator
- Completely silent switching, suitable for building and hospital applications
- Vibration resistant

Relays			
Contact types			
Circuit symbol	Contact configuration	EU nomenclature	USA nomenclature
	Make contact (Normally Open)	N/O	SPST-NO DPST-NO nPST-NO (1)
	Break contact (Normally Closed)	N/C	SPST-NC DPST-NC nPST-NC (1)
	Changeover Contact	C/O	SPDT DPDT nPDT (1)

Utilization categories		
Category	Type of current	Applications
AC-1	~ single-phase ~ 3-phase	Resistive or slightly inductive loads.
AC-3	~ 3-phase	Starting and braking of squirrel cage motors; reversing direction of rotation only after stopping of motor.
AC-4	~ 3-phase	Starting of squirrel cage motors, inching. Plugging, reversing direction of rotation.
DC-1	---	Resistive or slightly inductive loads (2).
AC-14	~ single-phase	Control of electromagnetic loads (< 72 VA), auxiliary control relays, power contactors, electromagnetic solenoid valves and electromagnets.
AC-15	~ single-phase	Control of electromagnetic loads (> 72 VA), auxiliary control relays, power contactors, electromagnetic solenoid valves and electromagnets.
DC-13	---	Control of electromagnetic loads, auxiliary control relays, power contactors, magnetic solenoid valves and electromagnets.

Protection categories		
Category	Explanation	Condition
RT 0	Unenclosed relay	Relay not provided with a protective case.
RT I	Dust protected relay	Relay provided with a case which protects its mechanism from dust.
RT II	Flux-proof relay	Relay capable of being automatically soldered without allowing the migration of solder fluxes beyond the intended areas.
RT III	Wash-tight relay	Relay capable of being automatically soldered and then washed to remove flux residues without risk of ingress of flux or washing solvents.
RT IV	Sealed relay	Relay provided with a case which has no venting to the outside atmosphere.
RT V	Hermetically sealed relay	Sealed relay having an enhanced level of sealing.

(1) n = number of contacts.

(2) The switchable voltage can be doubled, for an equal current, by connecting two contacts in series.

Protection modules

Whenever an inductive load is de-energized (coil of a relay or of a contactor), an overvoltage appears at its terminals. This voltage peak can reach several thousand volts and a frequency of several MHz.

It is likely to disturb the operation of automation systems which contain electronic devices.

Protection modules are used to reduce the voltage peak on de-energization and they therefore limit the energy of interference signals to a level that will not disturb surrounding coils and electronic devices.

These modules are used to avoid:

- electromagnetic compatibility problems
- the deterioration of contact materials
- the destruction of insulation due to overvoltage
- the destruction of electronic components

Diode protection module (with or without LED)

Advantages

- accumulation of energy allowing current flow in the same direction
- absence of any voltage peaks at the coil terminals
- low cost

Considerations

- increase in relay drop-out time (up to 3 to 4 times the usual time)
- no polarity protection
- de-energization of the relay

Protection module with varistor

Advantages

- can be used with \sim and --- supply
- voltage peak limited to about $2 U_n$
- little effect on relay drop-out time

Considerations

- no modification of coil's own oscillating frequency
- limitation of switching frequency

Protection module with RC circuit

Advantages

- coil oscillating frequency reduced to about 150 Hz
- voltage peak limited to $3 U_n$
- little effect on relay drop-out time

Considerations

- no protection for low voltages

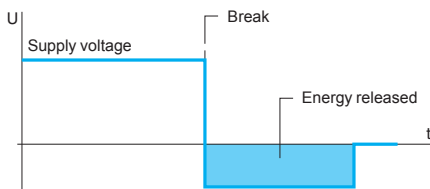

Coil voltage with diode protection module (--- only)

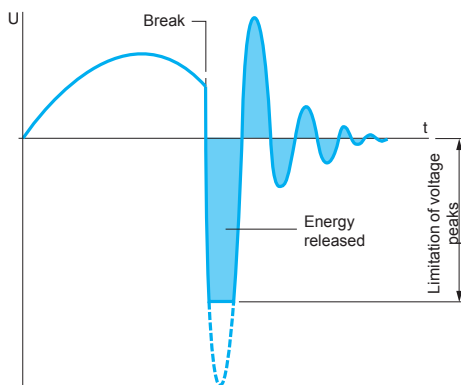

Coil voltage with varistor protection module (\sim and ---)

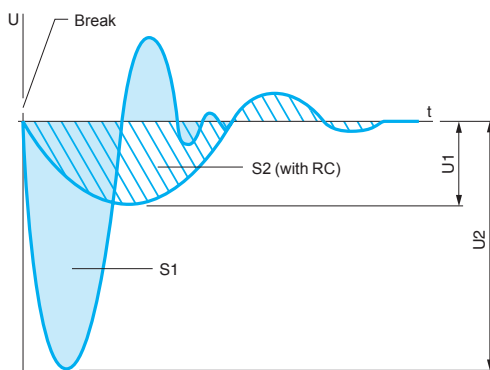

Coil voltage with RC circuit protection module (\sim only)

S1 = S2 = Energy released

Introduction

RSL slim interface relays offers compact size in a modular design: their slim width (6 mm) saves valuable space when mounting on a DIN rail at the back of an enclosure.

RSL relays are available in two versions:

■ **Pre-assembled range:** a single catalog number for a standard relay mounted on a socket.

- The socket includes a built-in protection circuit (against transients and reverse polarity voltages) and an LED indicator as standard.
- Wire connection options: screw connectors and spring terminals.
- This pre-assembled solution covers a wide range of operating voltages from 12 to 230 V.

■ **Individual relays and sockets:**

- The relay and the socket can be provided separately according to the requirements of the application.
- Simple maintenance: an RSL slim relay can be replaced without any need to disconnect the socket wiring.

Description

RSL slim interface relays, pre-assembled

- 1 6 A standard relay with 1 C/O contact.
- 2 Retention lever for easy removal of the relay from its socket.
- 3 Sockets: wire connection by screw connector or spring terminals.
- 4 All sockets have a built-in protection circuit and an LED indicator.



RSL slim interface relay

- 1 Five flat, reinforced PCB pins.

Sockets for RSL slim interface relays

- 1 Five female contacts for the relay pins.
- 2 Retention lever which accepts optional ID tags.
- 3 Wire connection by screw connector or spring terminals.
- 4 Built-in protection circuit and LED indicator.
- 5 Locating slot for mounting on DIN rail.

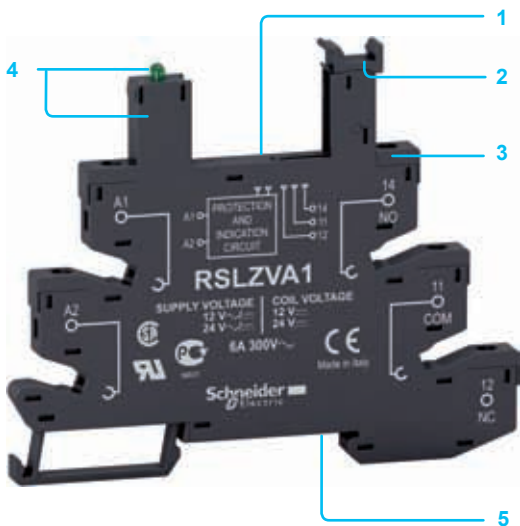

General characteristics			
Conforming to standards			IEC 61810-1, UL 508, CSA C22-2 No. 14
Product certifications			UL E173076, UL E172326, CSA 240278, CSA 247510, GOST
Ambient air temperature around the device	Storage	°C	- 40... + 85
	Operation	°C	- 40... + 55
Vibration resistance conforming to IEC/EN 60068-2-6	In operation		10 gn
	Not operating		5 gn
Degree of protection	Conforming to IEC/EN 60529		IP 40 (Relays) IP 20 (Sockets)
	Shock resistance conforming to IEC/EN 60068-2-27	Opening	10 gn
Closing		5 gn	
Protection category			RT III
Mounting position			Any
Insulation characteristics			
Rated insulation voltage (U_i)		V	250 (IEC)
Rated impulse withstand voltage (U_{imp})		kV	6
Dielectric strength (rms voltage)	Between coil and contact	~ V	4000
	Between contacts	~ V	1000

Contact characteristics				
Relay type		RSL1AB●●●		
Number and type of contacts		1 C/O standard		
Contact materials		AgSnO2		
Conventional thermal current (I _{th})	For ambient temperature ≤ 55 °C	A	6	
Rated operational current in utilization categories AC-1 and DC-1	Conforming to IEC	N/C	A 6	
		N/O	A 6	
	Conforming to UL	A	6	
Switching current	Minimum	mA	100	
Switching voltage	Rated	~ V	250	
	Maximum	V	~ 400, --- 300	
	Minimum	V	12	
Nominal load (resistive)		A / ~ V	6 / 250 V (at 50mW)	
Switching capacity	Maximum	~	VA	1500
		---	W	18...150 (depending on the voltage)
	Minimum		mW	120
Maximum operating rate In operating cycles / hour	No-load		72 000	
	Under load		360	
Mechanical durability	In millions of operating cycles		≥ 10	
Electrical durability In millions of operating cycles	Resistive load		See curves below	
	Inductive load		0.05 (N/O contact: ~250 V, 3 A, AC-15)	

Maximum switching capacity on --- load

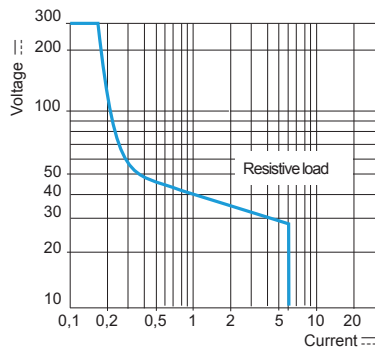

Coil characteristics						
Average consumption		---	W	0.17		
Drop-out voltage threshold		---		≥ 0.05 U _c		
Operating time (response time)	Between coil energization and making of the NO contact	---	ms	12 max		
	Between coil de-energization and making of the NC contact	---	ms	5 max		
Control circuit voltage U _c		V	12	24	48	60
Relay control voltage codes			JD	BD	ED	ND
DC supply	Average resistance at 23 °C ± 10%	Ω	848	3390	10 600	20 500
	Operating voltage limits	Min.	V	8.4	16.8	33.6
Max.		V	16.8	33.6	67.2	84

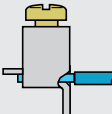
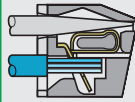
Socket characteristics			
Socket type		RSLZV●●	RSLZR●●
Relay types used		RSL1●●●●	RSL1●●●●
Conforming to standards		IEC 61984, UL 508, CSA C22-2 No. 14	
Product certifications		UL, CSA, GOST	
Contact terminal arrangement		Separate	Separate
Wire connection method		Screw connector	Spring terminals
Width	mm	6.2	6.2
Electrical characteristics			
Conventional thermal current (I _{th})	A	6	
Maximum operating voltage	~ V	300	
Insulation characteristics			
Between adjacent output contacts	V _{rms}	2500	
Between input and output contacts	V _{rms}	2500	
Between contacts and DIN rail	V _{rms}	2500	
General characteristics			
Ambient air temperature around the device	Operation	°C	-40...+70 (-40 to +55 for U > 80 V)
	Storage	°C	-40...+85
Degree of protection	Conforming to IEC/EN 60529		IP 20
Connection	Solid wire without 1 conductor cable end	mm ²	0.2...2.5
		AWG	24...14
	Flexible wire 1 conductor with cable end	mm ²	0.2...2.5
		AWG	24...14
Screw size	mm	M 2.5	
Maximum tightening torque	Nm	0.5	10 N...40 N (0.2 ... 1.5 mm ²)
Mounting		On 35 mm DIN rail	
Mounting on DIN rail		By plastic compression spring	
Terminal reference		IEC	
LED indicator		Yes (built-in)	
Added protection in circuit		Yes (built-in)	
Wire connection method		Screw connector	Spring terminal
			

Sockets operating voltage				
		Operating voltage	Tolerance	Control circuit voltage (relay)
		V		V
Socket type	RSLZVA1, RSLZRA1	~ / ~ 12	+ 20% / - 5%	~ 12
		~ / ~ 24	+ 20% / - 10%	~ 24
	RSLZVA2, RSLZRA2	~ / ~ 48	+ 20% / - 10%	~ 48
		~ / ~ 60	+ 20% / - 10%	~ 60
	RSLZVA3, RSLZRA3	~ / ~ 110	+ 15% / - 20%	~ 60
	RSLZVA4, RSLZRA4	~ / ~ 230	+ 15% / - 20%	~ 60



RSL 1PV●● RSL 1PR●●

Slim interface relays, pre-assembled

Standard relays mounted on socket equipped with LED and protection circuit
Sold in lots of 10

1 C/O contact - Thermal current (Ith) 6A

Operating voltage (input voltage) V	Socket type		Spring terminal		Replacement Relay
	Screw connector	Weight kg	Catalog Number	Weight kg	Catalog Number
~/~ 12	RSL1PVJU	0.031	RSL1PRJU	0.029	RSL1AB4JD
~/~ 24	RSL1PVBU	0.031	RSL1PRBU	0.029	RSL1AB4BD
~/~ 48	RSL1PVEU	0.031	RSL1PREU	0.029	RSL1AB4ED
~/~ 110	RSL1PVFU	0.031	RSL1PRFU	0.029	RSL1AB4ND
~/~ 230	RSL1PVPU	0.031	RSL1PRPU	0.029	RSL1AB4ND

Slim interface relays for customer assembly: relay + socket

Relays with flat, reinforced pins (PCB type)
Sold in lots of 10

1 C/O contact - Thermal current (Ith) 6A

Control circuit voltage (relay coil voltage) V	Standard	
	Catalog Number	Weight kg
~/~ 12	RSL1AB4JD	0.006
~/~ 24	RSL1AB4BD	0.006
~/~ 48	RSL1AB4ED	0.006
~/~ 60	RSL1AB4ND	0.006



RSL 1●●●●

Sockets equipped with LED and protection circuit
Sold in lots of 10

Operating voltage (input voltage) V	For use with relays	Socket type		Spring terminal	
		Screw connector	Weight kg	Catalog Number	Weight kg
~/~ 12 and ~/~ 24	RSL1AB4JD RSL1AB4BD	RSLZVA1	0.025	RSLZRA1	0.023
~/~ 48 and ~/~ 60	RSL1AB4ED RSL1AB4ND	RSLZVA2	0.025	RSLZRA2	0.023
~/~ 110	RSL1AB4ND	RSLZVA3	0.025	RSLZRA3	0.023
~/~ 230	RSL1AB4ND	RSLZVA4	0.025	RSLZRA4	0.023



RSL ZVA● RSL ZRA●

Accessories for sockets

Description	Compatibility	Catalog Number	Weight kg
Clip-in ID tags (2 sheets of 64 ID tags)	With all sockets	RSLZ5	0.001
Bus jumper (10 x 20-pole jumper)	With all sockets	RSLZ2	0.003
Butterfly isolator (10 isolators)	With all sockets	RSLZ3	0.001



RSL Z2



RSL Z3

Slim interface relays, pre-assembled

RSL1PV●● (screw connector)

RSL1PR●● (spring terminals)

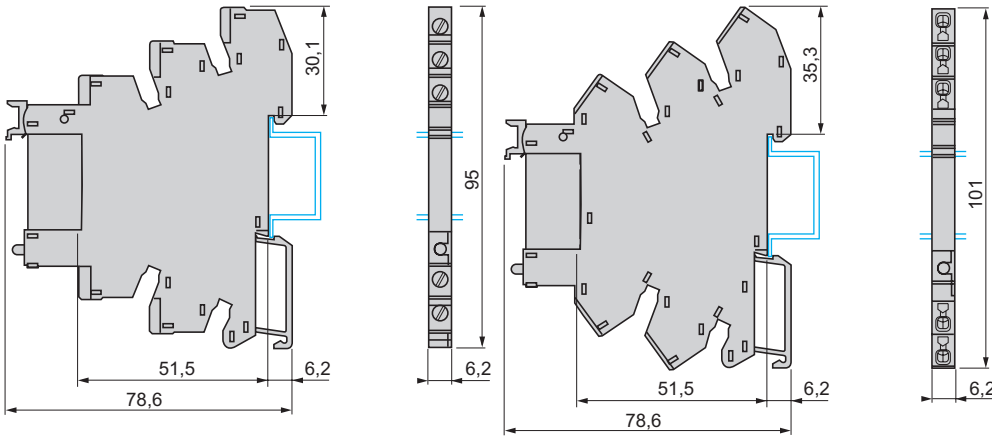

Relays

RSL1●●●● with flat, reinforced PCB pins

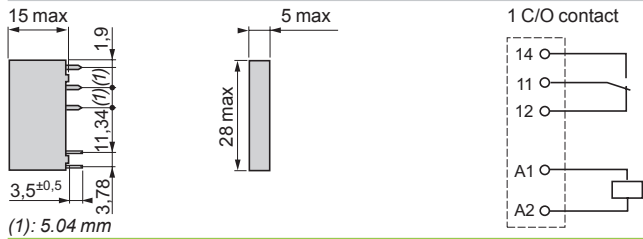

Sockets

RSLZV●● (screw connector)

RSLZR●● (spring terminals)

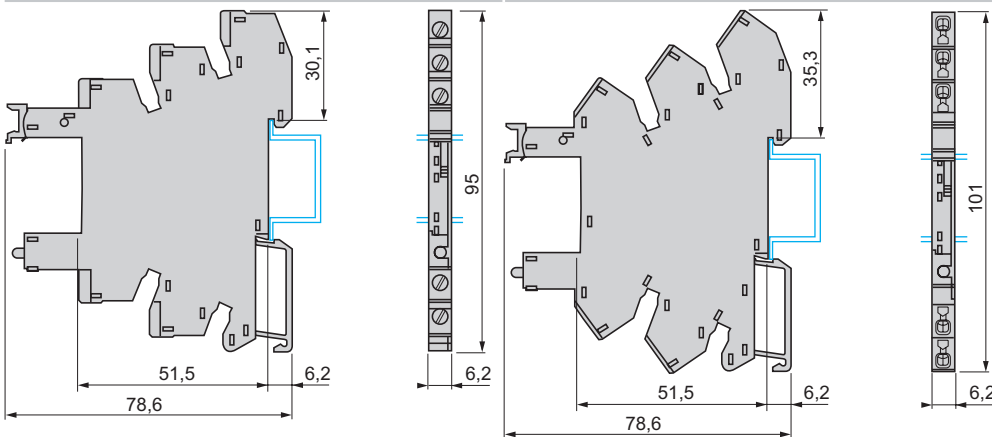

Socket connections

RSLZV●● (screw connector)

RSLZR●● (spring terminals)

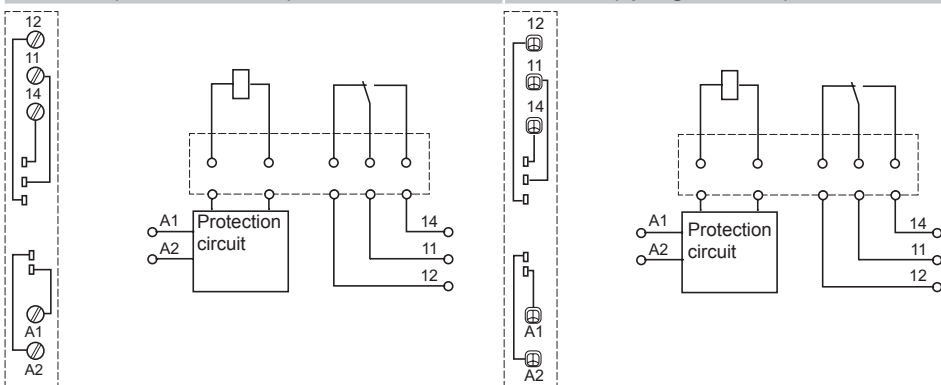



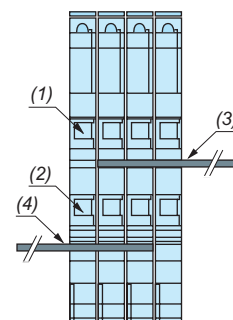

Example of RSL Z2 bus jumper mounting on sockets

Side view



- (1) A1
- (2) A2
- (3) Bus jumper polarity A1
- (4) Bus jumper polarity A2

Application	Plug-in relays		
	Interface relays	Miniature relays	
			
Number and type of contacts / conventional thermal current (Ith on N/O contact)	1 C/O / 16 A 1 C/O / 12 A 2 C/O / 8 A	2 C/O / 12 A 3 C/O / 10 A 4 C/O / 6 A 4 C/O / 3 A (low level)	
Control circuit voltage	24...240 V 6...110 V	24...240 V 12...220 V	
Type of pins	Flat, PCB type	Quick-connect	
Operational voltage	Up to ~ 400 V / 300 V	Up to 250 V	
Durability (operating cycles)	Electrical, resistive load: 100 000 Mechanical, no-load: 30 000 000	100 000 10 000 000	
Functions	LED Mechanical indicator Lockable test button Low level contacts	Yes (with protection modules) – – –	Yes (depending on version) Yes Yes Yes (depending on version)
Type reference	RSB	RXM	
Pages	20	24	
			
Conventional thermal current (Ith)	12 A (1)	10 A	12 A (2)
Contact terminal arrangements	Separate	Mixed	Separate
Connection	Box lug connectors	Screw clamp terminals or box lug connectors	Box lug connectors
Accessories	Protection modules: Yes Timer module: – Retention clip: Yes Socket ID tag: Yes Mounting adapters for rail: – Mounting adapters with fixing lugs: – Bus jumper, 2-pole (Ith = 5 A): –	Yes – Yes Yes (except RXZ E2M114) Yes Yes –	Yes – Yes Yes (except RXZ E2M114) Yes Yes Yes
Associated socket types	RSZE1S●●M	RXE2M●●●	RXE2S●●●
Pages	20	24	24

(1) When using relay RSB 1A160●● with socket RSZ E1S48M, terminals must be linked.
(2) Except for sockets RXZ E2S11●M: 10 A.

Universal relays



Power relays



2 C/O / 10 A
3 C/O / 10 A
3 C/O / 3 A (low level)

2 C/O / 10 A
3 C/O / 10 A

1 C/O / 15 A
2 C/O / 15 A
3 C/O / 15 A
4 C/O / 15 A

24...230 V
12...220 V

12...110 V

24...230 V
12...110 V

Cylindrical

Quick-connect

Quick-connect

Up to 250 V

Up to 250 V

100 000
5 000 000

100 000 (3)
10 000 000

Yes (depending on version)
Yes
Yes
Yes (depending on version)

Yes (depending on version)
Yes
Yes
-

RUM

32



RPM

42



12 A

16 A

Mixed

Separate

Mixed

Box lug connectors

Screw clamp terminals

Yes
Yes
Yes
Yes

Yes
Yes (for 3 and 4-pole)
Yes (on socket RPZ F1)

-
-

Yes
Yes
-

Yes

RUZC•M

RUZSC•M

RUZSF3M

RPZF•

32

32

42

(3) 100 000 for RPM1 and RPM2; 60 000 for RPM3 and RPM4.

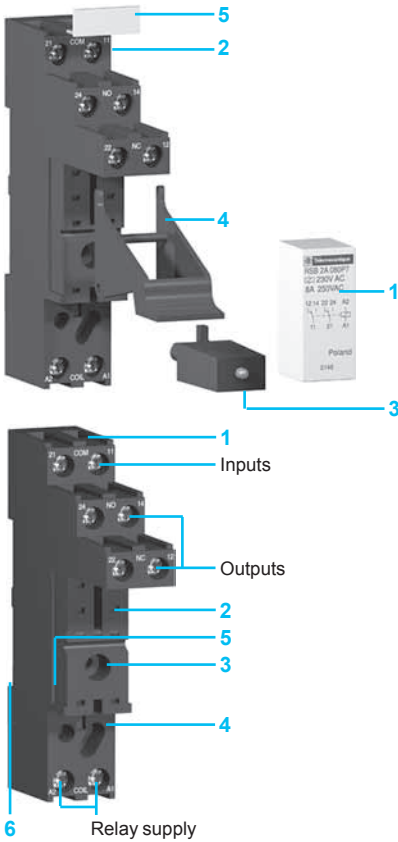

Introduction of the product range

The RSB interface relay range includes:

- 1 12 A relays with 1 C/O contact , 16 A relays with 1 C/O contact and 8 A relays with 2 C/O contacts.
- 2 Sockets with separate contact terminals.
- 3 Protection modules (diode, diode + LED, RC circuit or varistor + LED).
- 4 Plastic hold-down ejector clip for all sockets.
- 5 Clip-in ID tags for all sockets.

Socket description

Sockets with separate contact terminals (1)

- 1 Box lug connectors.
- 2 Five or eight female contacts for the relay pins.
- 3 Mounting hole for panel mounting.
- 4 Location for protection modules.
- 5 Locking components for plastic hold-down ejector clip.
- 6 Locating slot for mounting on DIN rail.

(1) The inputs and outputs are separated from the relay supply.

General characteristics

Conforming to standards		IEC/EN 61810-1, UL 508, CSA C22-2 n° 14
Product certifications		cURus File E173076 CNN NRNT2.; CSA File 215736 Class 321107; CE; RoHS compliant
Ambient air temperature around the device	Storage	°C (F) - 40... + 85 (-40 ... +185)
	Operation	°C (F) --- - 40... + 85 (-40 ... +185), ~ - 40... + 70 (-40 ... +158)
Vibration resistance	Conforming to IEC/EN 60068-2-6	> 10 gn (10..150 Hz)
Degree of protection	Conforming to IEC/EN 60529	IP 40
Shock resistance conforming to IEC/EN 60068-2-27	Opening	5 gn
	Closing	10 gn
Protection category		RT I
Mounting position		Any

Insulation characteristics

Rated insulation voltage (Ui)	Conforming to IEC/EN 60947	V	400
Rated impulse withstand voltage (Uimp)		kV	3.6 (1.2/50 µs)
Dielectric strength (rms voltage)	Between coil and contact	~ V	5000
	Between poles	~ V	2500
	Between contacts	~ V	1000

Contact characteristics

Relay type			RSB1A120●●	RSB1A160●●	RSB2A080●●
Number and type of contacts			1 C/O	1 C/O	2 C/O
Contact materials			AgNi		
Conventional thermal current (Ith)	For ambient temperature ≤ 40°C	A	12	16	8
	Conforming to IEC	N.O.	A	12	16
Rated operational current in utilization categories AC-1 and DC-1		N.C.	A	6	4
	Switching current	Minimum	mA	5	
Switching voltage	Maximum	V	~ 400, --- 300		
	Minimum	V	5		
Nominal load (resistive)		A	12 / 250 ~ V	16 / 250 ~ V	8 / 250 ~ V
		A	12 / 28 --- V	16 / 28 --- V	8 / 28 --- V
Switching capacity	Maximum	~	VA	3000	4000
		---	W	336	448
	Minimum	mW	300		
Maximum operating rate In operating cycles/hour	No-load		72 000		
	Under load		600		



RSB 1A120JD + RZM 031FPD + RSZ E1S35M



RSB 1A160BD + RSZ E1S48M



RSB 2A080BD + RSZ E1S48M

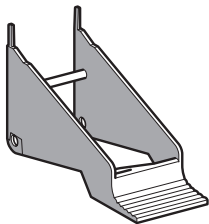

RSZ R215

Relays for standard applications					
Control circuit voltage	Sold in lots of	Number and type of contacts - Thermal current (Ith)			Weight
		1 C/O - 12 A	1 C/O - 16 A	2 C/O - 8 A	
		Catalog number (1)	Catalog number (1)	Catalog number (1)	
V					kg
--- 6	10	RSB1A120RD	RSB1A160RD	RSB2A080RD	0.014
--- 12	10	RSB1A120JD	RSB1A160JD	RSB2A080JD	0.014
--- 24	10	RSB1A120BD	RSB1A160BD	RSB2A080BD	0.014
--- 48	10	RSB1A120ED	RSB1A160ED	RSB2A080ED	0.014
--- 60	10	RSB1A120ND	RSB1A160ND	RSB2A080ND	0.014
--- 110	10	RSB1A120FD	RSB1A160FD	RSB2A080FD	0.014
~ 24	10	RSB1A120B7	RSB1A160B7	RSB2A080B7	0.014
~ 48	10	RSB1A120E7	RSB1A160E7	RSB2A080E7	0.014
~ 120	10	RSB1A120F7	RSB1A160F7	RSB2A080F7	0.014
~ 220	10	RSB1A120M7	RSB1A160M7	RSB2A080M7	0.014
~ 230	10	RSB1A120P7	RSB1A160P7	RSB2A080P7	0.014
~ 240	10	RSB1A120U7	RSB1A160U7	RSB2A080U7	0.014

Sockets 12 A, ~ 300 V					
Contact terminal arrangement	Connection	Relay type	Sold in lots of	Catalog number	Weight kg
Separate	Box lug connectors	RSB1A120●●	10	RSZE1S35M	0.060
		RSB1A160●● (2)	10	RSZE1S48M	0.050
		RSB2A080●●			

Protection modules					
Description	For use with	Voltage	Sold in lots of	Catalog number	Weight
					kg
Diode	All sockets	--- 6...230	10	RZM040W	0.003
		~ 24...60	10		RZM041BN7
RC circuit	All sockets	~ 110...240	10	RZM041FU7	0.010
		--- 6...24	10		RZM031RB
Diode + green LED	All sockets	~ 24...60	10	RZM031BN	0.004
		--- 110...230	10	RZM031FPD	0.004
		--- or ~ 6...24	10	RZM021RB	0.005
Varistor + green LED	All sockets	--- or ~ 24...60	10	RZM021BN	0.005
		--- or ~ 110...230	10	RZM021FP	0.005

Accessories					
Description	For use with	Sold in lots of	Catalog number	Weight	kg
Plastic hold-down ejector clip	All sockets	10	RSZR215	0.002	
ID tag	All sockets	10	RSZL300	0.001	

(1) To order a relay complete with socket (sold in lots of 20): add suffix S to one of the following voltage codes JD, BD, B7, P7 or F7.
Example: RSB2A080BD + RSZE1S48M becomes RSB2A080RBS.
(2) When using the relay with socket RSZE1S48M, terminals must be linked. See wiring diagrams on page 23.

Dimensions (mm):

Interface relays

RSB1A120●●

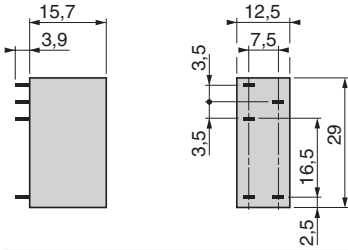

RSB2A080●●, RSB1A160●●

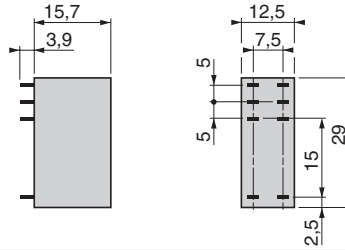

Sockets

RSZE1S35M

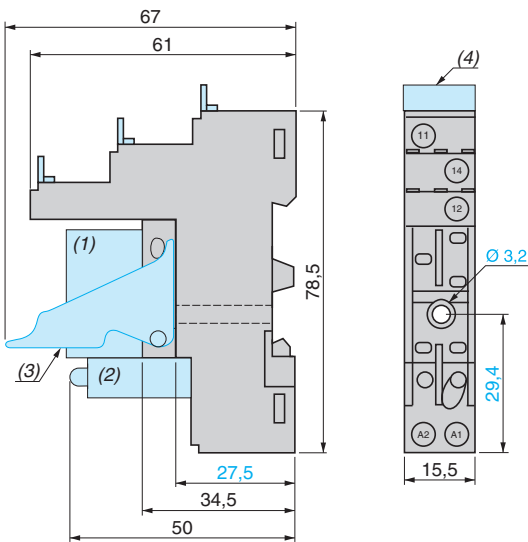

RSZE1S48M

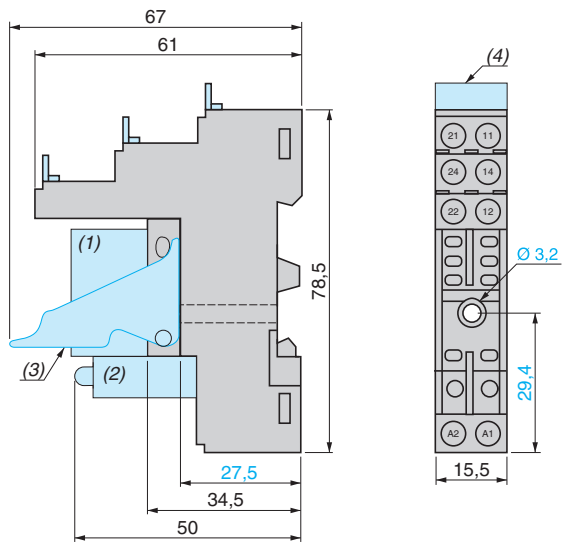

- (1) Relays
- (2) Protection module
- (3) Retention clip
- (4) ID tag

Wiring diagrams

Interface relays

RSB1A120●●

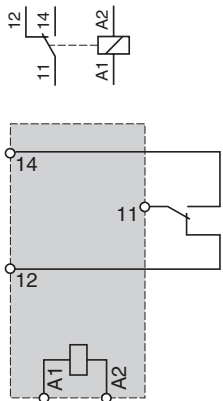

RSB1A160●●

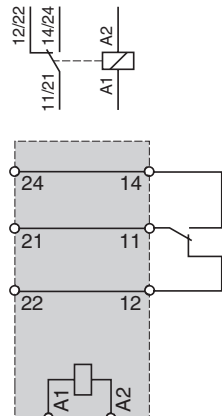

RSB2A080●●

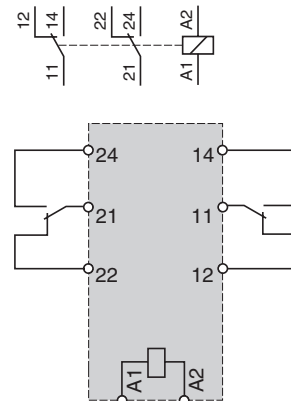

When using relay RSB 1A160●● with socket RSZ E1S48M terminals 11 and 21, 14 and 24, 12 and 22 must be linked

Protection modules

RZM040W

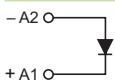

RZM041●●●

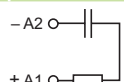

RZM031●●●

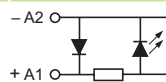

RZM021●●●

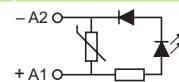

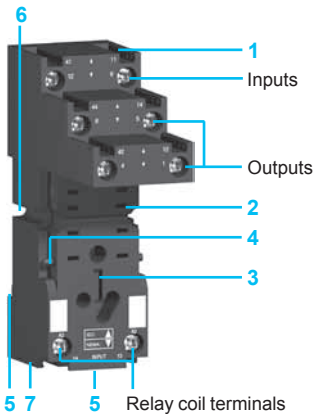
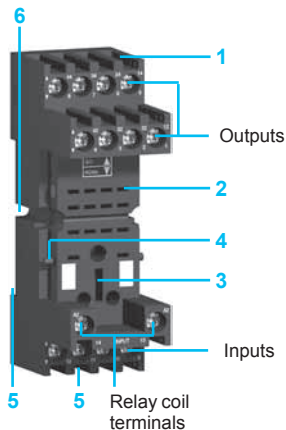
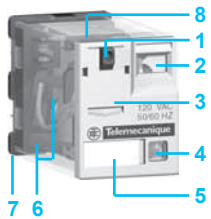
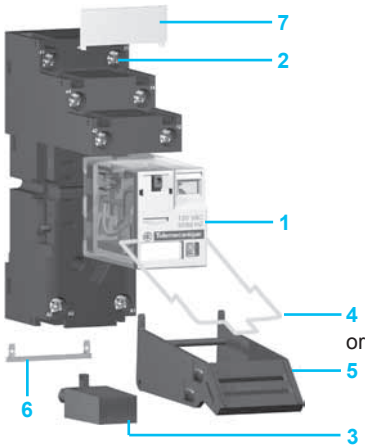

Introduction of the product range

The RXM miniature relay range includes:

- 1 12 A relays with 2 C/O contacts, 10 A relays with 3 C/O contacts, 6 A relays with 4 C/O contacts and 3 A "low level" relays with 4 C/O contacts. All these relays have the same dimensions.
- 2 Sockets with mixed or separate contact terminals.
- 3 Protection modules (diode, RC circuit or varistor).
- 4 Metal hold-down clip for all sockets.
- 5 Plastic hold-down ejector clip for all sockets.
- 6 2-pole bus jumper that can be used on sockets with separate contact terminals in order to simplify wiring when creating a jumper between the coil terminals.
- 7 Clip-in ID tags for all the sockets except RXZE2M114.

Relay description

- 1 Spring return push-to-test button for checking contact operation (green: $\overline{\text{---}}$, red: \sim).
- 2 Mechanical "relay status" indicator.
- 3 Optional removable lock-down door enables continuous engagement of the contacts for test or maintenance purposes. During operation, this lock-down door must always be in the closed position.
- 4 Bipolar LED (depending on version) indicating the relay status.
- 5 Removable ID tag for relay identification.
- 6 Four notches for DIN rail mounting adapter or panel mounting adapter with fixing lugs.
- 7 Eight, eleven or fourteen quick-connect pins.
- 8 Area by which the product can be easily gripped.
- 9 Mounting adapter enabling direct mounting of the relay on a panel.
- 10 Mounting adapter enabling direct mounting of the relay on a DIN rail.

Socket description

Sockets with mixed contact terminals (1)

- 1 Connection by screw clamp terminals or box lug connector.
- 2 Fourteen female contacts for the relay pins.
- 3 Location for protection modules.
- 4 Locking components for plastic and metal hold-down clips.
- 5 Locating slot for mounting on DIN rail.
- 6 Two or four mounting holes for panel mounting.

Sockets with separate contact terminals (2)

- 1 Connection by screw connector.
- 2 Eight, eleven or fourteen female contacts for the relay pins.
- 3 Location for protection modules.
- 4 Locking components for plastic and metal hold-down clips.
- 5 Locating slot for mounting on DIN rail.
- 6 Two mounting holes for panel mounting.
- 7 Location for bus jumpers (see mounting on sockets on page 30).

(1) The inputs are mixed with the relay coil terminals, with the outputs being located on the opposite side of the socket.

(2) The inputs and outputs are separated from the relay coil terminals.

General characteristics

Conforming to standards			IEC/EN 61810-1 (iss. 2), UL 508, CSA C22-2 n° 14
Product certifications			cULus File E164862 CCN NLDX, NLDX7; cURus File E164862 CCN NLDX2, NLDX8; CSA; CE; RoHS compliant
Ambient air temperature around the device	Storage	°C (F)	-40... +85 (-40... +185)
	Operation	°C (F)	-40... +55 (-40... +131)
Vibration resistance conforming to IEC/EN 60068-2-6	In operation		3 gn (10...150 Hz/± 1 mm / 5g/5 cycles)
	Not operating		5 gn (10...150 Hz/± 1 mm / 5g/5 cycles)
Degree of protection	Conforming to IEC/EN 60529		IP 40
Shock resistance conforming to IEC/EN 60068-2-27	Opening		15 gn
	Closing		15 gn
Protection category			RT I
Mounting position			Any

Insulation characteristics

Rated insulation voltage (U_i)	V	250 (IEC), 300 (UL, CSA)	
Rated impulse withstand voltage (U_{imp})	kV	4 (1.2/50 μs)	
Dielectric strength (rms voltage)	Between coil and contact	~ V	1550
	Between poles	~ V	1550
	Between contacts	~ V	1500

Contact characteristics

Relay type			RXM2AB●●●	RXM3AB●●●	RXM4AB●●●	RXM4GB●●●	
Number and type of contacts			2 C/O	3 C/O	4 C/O	4 C/O low level	
Contact materials			AgNi			AgAu - bifurcated	
Conventional thermal current (I_{th})	For ambient temperature ≤ 55 °C	A	12	10	6	3	
Rated operational current in utilization categories AC-1 and DC-1	Conforming to IEC	NO	12	10	6	2	
		NC	6	5	3	1	
	Conforming to UL		12	10	6	3	
Switching current	Minimum	mA	10			3	
Switching voltage	Maximum	V	~/~ 250 (IEC)				
	Minimum	V	17			5	
Nominal load (resistive)		A	12 / 250 ~ V	10 / 250 ~ V	6 / 250 ~ V	3 / 250 ~ V	
		A	12 / 28 ~ V	10 / 28 ~ V	6 / 28 ~ V	3 / 28 ~ V	
Switching capacity	Maximum	~	VA	3000	2500	1500	750
		~	W	336	280	168	84
	Minimum	mW	170			15	
Maximum operating rate In operating cycles	No-load		18 000				
	Under load		1200				
Utilization coefficient			20 %				
Mechanical durability	In millions of operating cycles		10				
Electrical durability In millions of operating cycles	Resistive load		0.1				
	Inductive load		See curves below				

Electrical durability of contacts

Resistive load ~

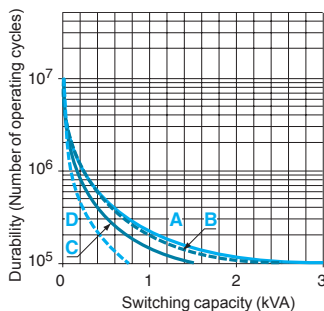

Reduction coefficient for inductive load ~
(depending on power factor cos φ)

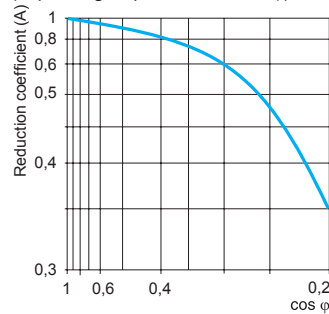

Maximum switching capacity on resistive load ~

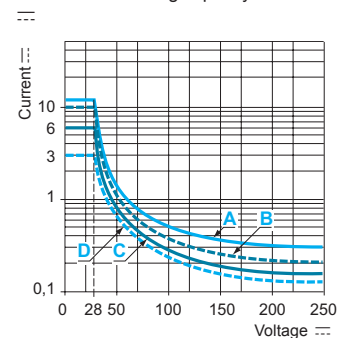

A RXM2AB●●● **B** RXM3AB●●● **C** RXM4AB●●● **D** RXM4GB●●●

Inductive load durability = resistive load durability x reduction coefficient.

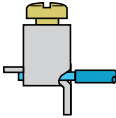
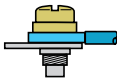
Coil characteristics												
Average consumption		~	VA	1.2								
			W	0.9								
Drop-out voltage threshold		~		≥ 0.15 U _c								
				≥ 0.1 U _c								
Operating time (response time)	Between coil energization and making of the NO contact	~	ms	20								
			ms	20								
	Between coil de-energization and making of the NC contact	~	ms	20								
			ms	20								
Control circuit voltage U _c			V	12	24	48	110	120	125	220	230	240
Relay coil voltage codes				JD	BD	ED	FD	–	GD	MD	–	–
d.c. supply	Average resistance at 20 °C ± 10%		Ω	160	650	2600	11 000	–	11 000	14 000	–	–
	Operating voltage limits	Min.	V	9.6	19.2	38.4	88	–	100	176	–	–
		Max.	V	13.2	26.4	52.8	121	–	138	242	–	–
Relay coil voltage codes				–	B7	E7	–	F7	–	–	P7	U7
a.c. supply	Average resistance at 20 °C ± 15%		Ω	–	180	770	–	4430	–	–	15 000	15 500
	Operating voltage limits	Min.	V	–	19.2	38.4	–	96	–	–	184	192
		Max.	V	–	26.4	52.8	–	132	–	–	253	264
Socket characteristics												
Socket type				RXZE2S108M	RXZE2S111M	RXZE2S114M	RXZE2M114M	RXZE2M114				
Relay types used				RXM2●●●●●	RXM3●●●●●	RXM4●●●●●	RXM2●●●●● (1) RXM4●●●●●	RXM2●●●●● (1) RXM4●●●●●				
Contact terminal arrangement				Separate				Mixed				
Wire connection method				Box lug connectors							Screw clamp terminals	
Product certifications				cURus File E172326 CCN SWIV2, SWIV8; CSA; CE; RoHS compliant								
Conforming to standards				IEC 61984, CE								
Electrical characteristics												
Conventional thermal current (I _{th})			A	12	10							
Maximum operating voltage			V	250 (IEC)								
Insulation characteristics												
Between adjacent output contacts			V _{rms}	2500								
Between input and output contacts			V _{rms}	2500								
Between contacts and DIN rail			V _{rms}	2500								
General characteristics												
Ambient air temperature around the device	Operation		°C (F)	- 40...+ 55 (-40... +131)								
	Storage		°C (F)	- 40...+ 85 (-40... +185)								
Degree of protection			Conforming to IEC/EN 60529								IP 20	
Connection	Solid wire without cable end	1 conductor	0.5...2.5 mm ² - AWG 20...AWG 14							0.5... 1.5 mm ² AWG 20...AWG 16		
		2 conductors	0.5... 1.5 mm ² - AWG 20...AWG 16									
	Flexible wire with cable end	1 conductor	0.25...2.5 mm ² - AWG 22...AWG 14							0.25...1 mm ² AWG 22...AWG 17		
		2 conductors	0.25...1 mm ² - AWG 22...AWG 17									
Maximum tightening torque / Screw size			Nm	1 / M3 screw								
Mounting				35 mm DIN rail / panel mount								
Mounting on DIN rail				By red plastic clip				By metal compression spring		By red plastic clip		
Terminal referencing				IEC, NEMA								
Bus jumper (I _{th} : 5 A)				Yes				No				
Compatibility with the plastic hold-down ejector clip				Yes								
Compatibility with the metal hold-down clip				Yes								
Protection module				All RXM040W, RXM041●●, RXM021●●								
Clip-in ID tags				Yes							No	
Wire connection method				Box lug connector							Screw clamp terminals	
												

(1) When mounting relay RXM2●●●●● on socket RXZE2M●●●●●, the thermal current must not exceed 10 A.



RXM AB1F7



RXM AB2F7



RXM4GB1F7



RXM4GB2F7

Miniature relays without LED (sold in lots of 10)						
Control circuit voltage	Number and type of contacts - Thermal current (Ith)					
	2 C/O - 12 A		3 C/O - 10 A		4 C/O - 6 A	
	Catalog number	Weight	Catalog number	Weight	Catalog number	Weight
V	kg		kg		kg	
⎓ 12	RXM2AB1JD	0.037	RXM3AB1JD	0.037	RXM4AB1JD	0.037
⎓ 24	RXM2AB1BD	0.037	RXM3AB1BD	0.037	RXM4AB1BD	0.037
⎓ 48	RXM2AB1ED	0.037	RXM3AB1ED	0.037	RXM4AB1ED	0.037
⎓ 110	RXM2AB1FD	0.037	RXM3AB1FD	0.037	RXM4AB1FD	0.037
⎓ 220	-	-	-	-	RXM4AB1MD	0.037
~ 24	RXM2AB1B7	0.037	RXM3AB1B7	0.037	RXM4AB1B7	0.037
~ 48	RXM2AB1E7	0.037	RXM3AB1E7	0.037	RXM4AB1E7	0.037
~ 120	RXM2AB1F7	0.037	RXM3AB1F7	0.037	RXM4AB1F7	0.037
~ 230	RXM2AB1P7	0.037	RXM3AB1P7	0.037	RXM4AB1P7	0.037
~ 240	-	-	-	-	RXM4AB1U7	0.037

Miniature relays with LED (sold in lots of 10)						
Control circuit voltage	Number and type of contacts - Thermal current (Ith)					
	2 C/O - 12 A		3 C/O - 10 A		4 C/O - 6 A	
	Catalog number	Weight	Catalog number	Weight	Catalog number	Weight
V	kg		kg		kg	
⎓ 12	RXM2AB2JD	0.037	RXM3AB2JD	0.037	RXM4AB2JD	0.037
⎓ 24	RXM2AB2BD	0.037	RXM3AB2BD	0.037	RXM4AB2BD	0.037
⎓ 48	RXM2AB2ED	0.037	RXM3AB2ED	0.037	RXM4AB2ED	0.037
⎓ 110	RXM2AB2FD	0.037	RXM3AB2FD	0.037	RXM4AB2FD	0.037
⎓ 125	-	-	-	-	RXM4AB2GD	0.037
~ 24	RXM2AB2B7	0.037	RXM3AB2B7	0.037	RXM4AB2B7	0.037
~ 48	RXM2AB2E7	0.037	RXM3AB2E7	0.037	RXM4AB2E7	0.037
~ 120	RXM2AB2F7	0.037	RXM3AB2F7	0.037	RXM4AB2F7	0.037
~ 230	RXM2AB2P7	0.037	RXM3AB2P7	0.037	RXM4AB2P7	0.037

Miniature relays with low level contacts, without LED (sold in lots of 10)			
Control circuit voltage	Number and type of contacts - Thermal current (Ith)		
	4 C/O - 3 A		
	Catalog number	Weight	
V		kg	
⎓ 12	RXM4GB1JD	0.037	
⎓ 24	RXM4GB1BD	0.037	
⎓ 48	RXM4GB1ED	0.037	
⎓ 110	RXM4GB1FD	0.037	
~ 24	RXM4GB1B7	0.037	
~ 48	RXM4GB1E7	0.037	
~ 120	RXM4GB1F7	0.037	
~ 230	RXM4GB1P7	0.037	

Miniature relays with low level contacts, with LED (sold in lots of 10)			
Control circuit voltage	Number and type of contacts - Thermal current (Ith)		
	4 C/O - 3 A		
	Catalog number	Weight	
V		kg	
⎓ 12	RXM4GB2JD	0.037	
⎓ 24	RXM4GB2BD	0.037	
⎓ 48	RXM4GB2ED	0.037	
⎓ 110	RXM4GB2FD	0.037	
~ 24	RXM4GB2B7	0.037	
~ 48	RXM4GB2E7	0.037	
~ 120	RXM4GB2F7	0.037	
~ 230	RXM4GB2P7	0.037	
~ 240	RXM4GB2U7	0.037	



RXZE2M114M
+
Relais RXM4AB2F7



RXZE2S114M
+
Relais RXM4AB2F7



RXM041●●7



REXL4●●



RXZ400

Miniature relays without LED (sold in lots of 100)					
Control circuit voltage	Number and type of contacts - Thermal current (Ith)			4 C/O - 6 A	
	2 C/O - 12 A			Catalog number	Weight
	Catalog number	Weight		Catalog number	Weight
V		kg			kg
--- 12	-	-		RXM4AB1JDTQ	0.036
--- 24	RXM2AB1BDTQ	0.037		RXM4AB1BDTQ	0.036
--- 48	-	-		RXM4AB1EDTQ	0.036
--- 110	-	-		RXM4AB1FDTQ	0.036
--- 220	-	-		RXM4AB1MDTQ	0.036
~ 24	RXM2AB1B7TQ	0.037		RXM4AB1B7TQ	0.036
~ 48	-	-		RXM4AB1E7TQ	0.036
~ 120	RXM2AB1F7TQ	0.037		RXM4AB1F7TQ	0.036
~ 230	RXM2AB1P7TQ	0.037		RXM4AB1P7TQ	0.036

Miniature relays with LED (sold in lots of 100)					
--- 24	-	-		RXM4AB2BDTQ	0.036
~ 24	RXM2AB2B7TQ	0.037		RXM4AB2B7TQ	0.036
~ 230	RXM2AB2P7TQ	0.037		RXM4AB2P7TQ	0.036

Sockets					
Contact terminal arrangement	Connection	Relay type	Sold in lots of	Catalog number	Weight kg
Mixed	Screw clamp terminals	RXM2●●●● (3) RXM4●●●●	10	RXZE2M114 (1)	0.048
	Box lug connector	RXM2●●●● (3) RXM4●●●●	10	RXZE2M114M (1)	0.056
Separate	Box lug connector	RXM2●●●●	10	RXZE2S108M (2)	0.058
		RXM3●●●●	10	RXZE2S111M (1)	0.066
		RXM4●●●●	10	RXZE2S114M (1)	0.070

Protection modules					
Description	Voltage	For use with	Sold in lots of	Catalog number	Weight kg
	V				kg
Diode	--- 6...250	All sockets	20	RXM040W	0.003
RC circuit	~ 24...60	All sockets	20	RXM041BN7	0.010
	~ 110...240	All sockets	20	RXM041FU7	0.010
Varistor	~ / --- 6...24	All sockets	20	RXM021RB	0.030
	~ / --- 24...60	All sockets	20	RXM021BN	0.030
	~ / --- 110...240	All sockets	20	RXM021FP	0.030

Timing relays				
Description	For use with	Catalog number	Weight kg	
2 or 4 timed C/O contacts (function A)	Sockets RXZE●●●●●	REXL2●● (4)	-	
		REXL4●● (4)	-	

Accessories				
Description	For use with	Sold in lots of	Catalog number	Weight kg
Metal hold-down clip	All sockets	10	RXZ400	0.001
Plastic hold-down ejector clip	All sockets	10	RXZR335	0.005
Bus jumper 2-pole (Ith: 5 A)	All sockets with separate contacts	10	RXZS2	0.005
Mounting adapter for DIN rails (5)	All relays	10	RXZE2DA	0.004
Mounting adapter with fixing lugs for panel	All relays	10	RXZE2FA	0.002
Clip-in ID tags	All relays (sheet of 108 ID tags)	10	RXZL520	0.080
	All sockets except RXZ E2M114	10	RXZL420	0.001

(1) Thermal current Ith: 10 A
 (2) Thermal current Ith: 12 A
 (3) When mounting relay RXM2●●●●● on socket RXZE2M●●●●●, the thermal current must not exceed 10 A.
 (4) Please consult the "Zelio Time - timing relays" catalog.
 (5) Test button becomes inaccessible.

Dimensions (mm):

Miniature relays

RXM●●●●●

Common view

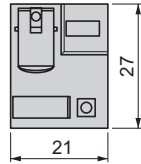
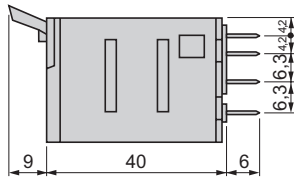

RXM2

Pin side view

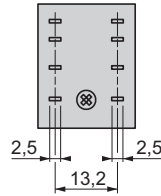

RXM3

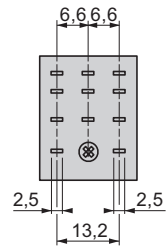

RXM4

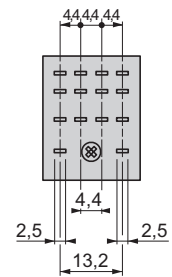

Sockets

RXZE2M114

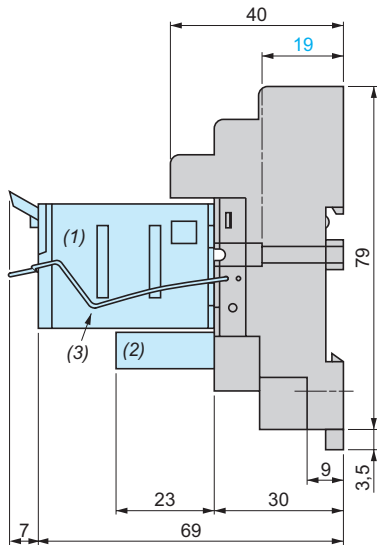

RXZE2M114M

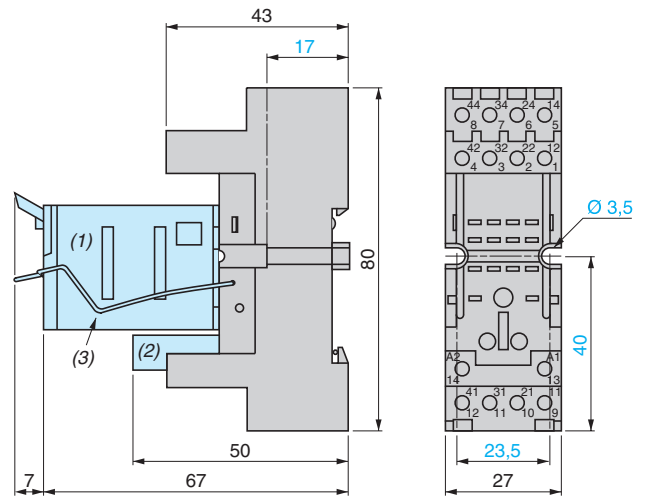

Common side view

RXZE2S108M

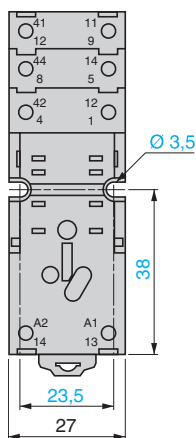
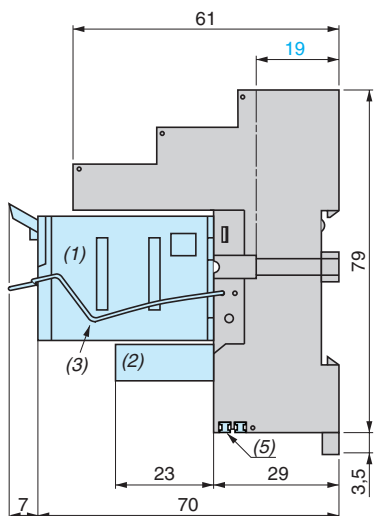

RXZE2S111M

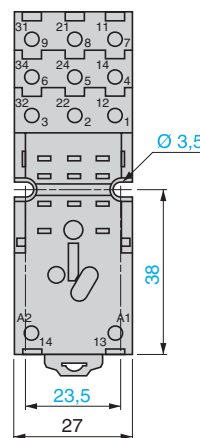

RXZE2S114M

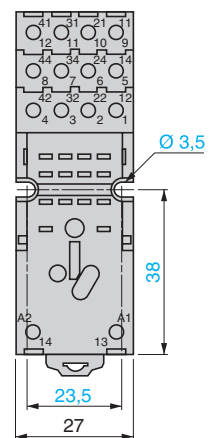

- (1) Relay
- (2) Protection module
- (3) Metal hold-down clip
- (4) 2 elongated holes Ø 3.5 x 6.5
- (5) 2 bus jumpers

Dimensions (mm):

Plastic hold-down clip and clip-in ID tags

RXZR335

RXZL420

Mounting on all sockets (1)

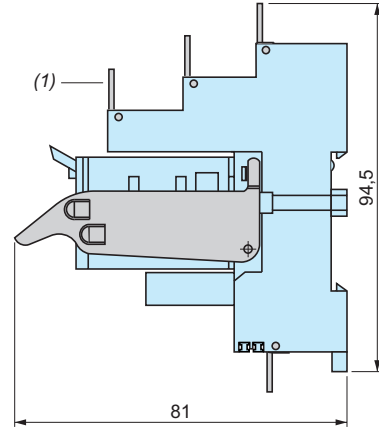
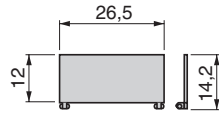
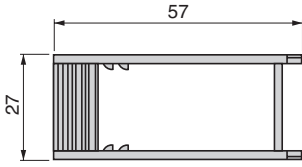

(1) Clip-in ID tags for all sockets except RXZE2M114

Bus jumper

RXZS2

Mounting on sockets with separate contacts
(view from below)

Metal hold-down clip

RXZ400

Example of bus jumper mounting on sockets

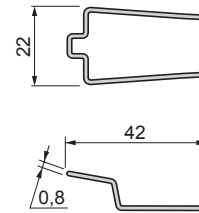
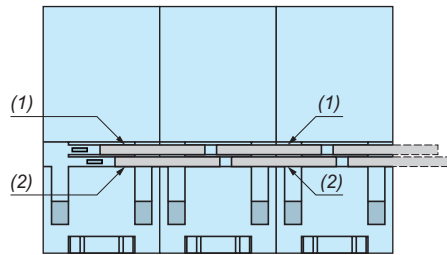
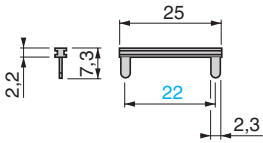

(1) 2 bus jumpers (polarity A2)
(2) 2 bus jumpers (polarity A1)

Mounting adapter for DIN rails (1)

RXZE2DA

Mounting adapter for panel

RXZE2FA

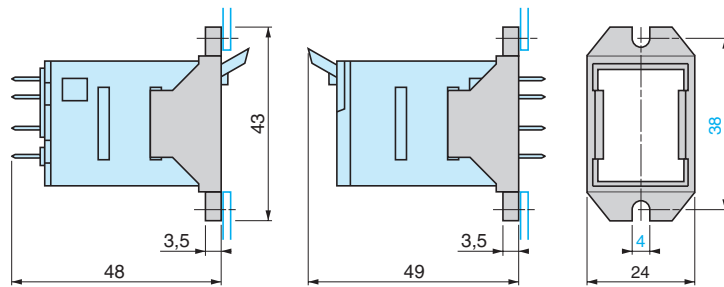
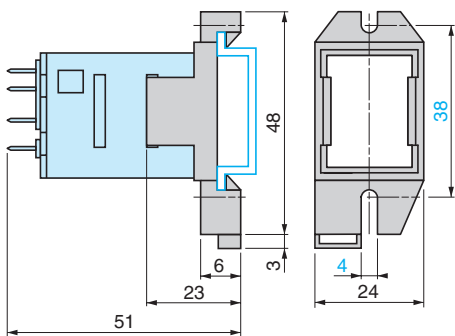

(1) Test button becomes inaccessible

Internal connections

Miniature relays

RXM2●●●●●

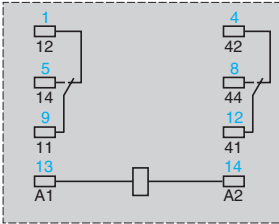
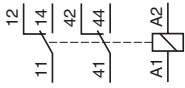

RXM3●●●●●

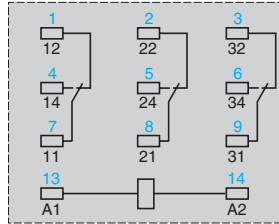
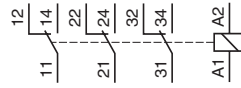

RXM4●●●●●

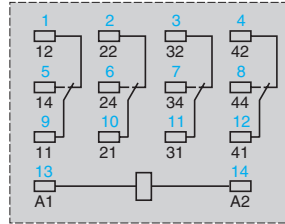
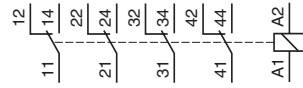

Symbols shown in blue correspond to Nema marking.

Sockets

RXZE2M114

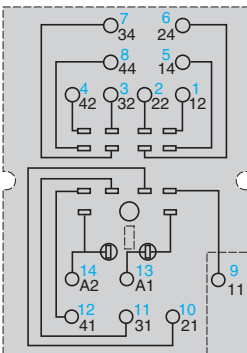

RXZE2M114M

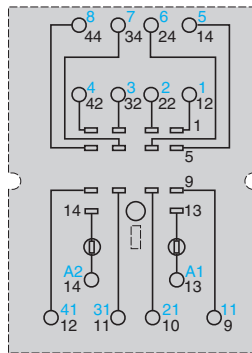

Symbols shown in blue correspond to Nema marking.

RXZE2S108M

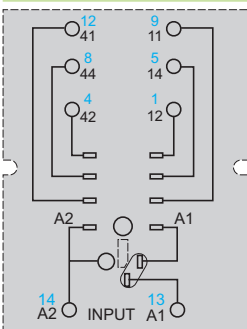

RXZE2S111M

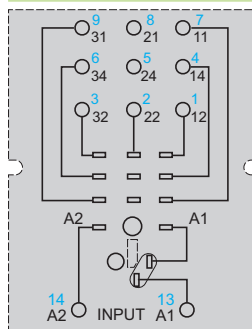

RXZE2S114M

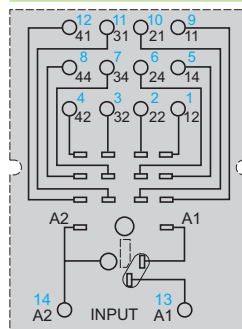

Symbols shown in blue correspond to Nema marking.

Protection modules

RXM040W

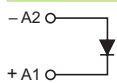

RXM041●●●

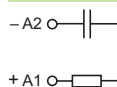

RXM021●●●

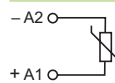

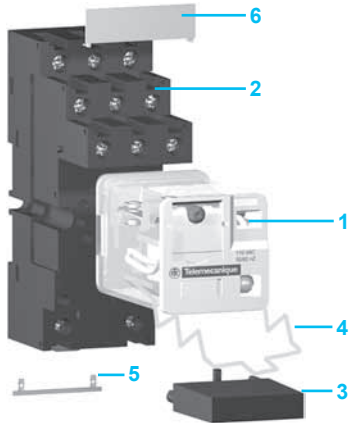

Introduction of the product range

The RUM universal relay range includes:

- 1 10 A relays with 2 and 3 C/O contacts, with cylindrical or quick-connect terminals, and 3 A low level relays with 3 C/O contacts, with cylindrical pins. All RUM relays have the same dimensions.
- 2 Sockets with mixed or separate contact terminals.
- 3 Protection modules (diode, RC circuit or varistor) or 1 timer module.
- 4 Metal hold-down clip for all sockets.
- 5 2-pole bus jumper that can be used on sockets with separate contact terminals in order to simplify wiring when creating a jumper between the coil terminals.
- 6 Clip-in ID tags for the sockets.

Relay description

- 1 Spring return push-to-test button for checking contact operation (green: ---, red: ~).
- 2 Mechanical “relay status” indicator.
- 3 Optional removable lock-down door enables continuous engagement of the contacts for test or maintenance purposes. During operation, this lock-down door must always be in the closed position.
- 4 Bipolar LED (depending on version) indicating the relay status.
- 5 Removable ID tag for relay identification.
- 6 Area by which the product can be easily gripped.
- 7 Eight or eleven cylindrical pins.
- 8 Eight or eleven quick-connect pins

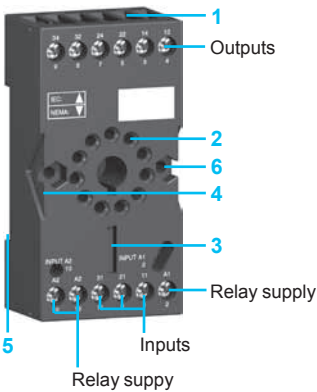

Socket description

Sockets with mixed contact terminals (1)

- 1 Box lug connectors.
- 2 Eight or eleven female contacts for the relay cylindrical pins.
- 3 Location for protection modules or the timer module.
- 4 Locking component for metal hold-down clip.
- 5 Locating slot for mounting on DIN rail.
- 6 Two mounting holes for panel mounting.

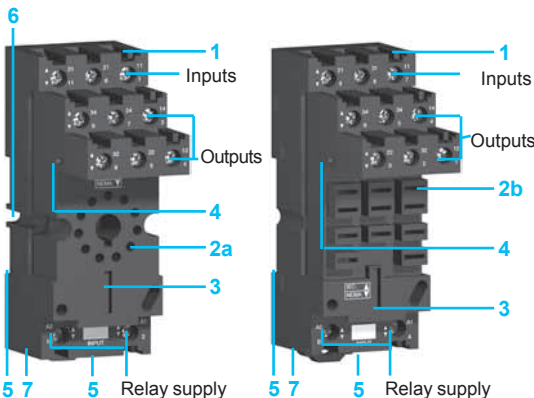

Sockets with separate contact terminals (2)

- 1 Box lug connectors.
- 2 a Eight or eleven female contacts for the relay cylindrical pins.
b Eleven female contacts for the relay flat pins.
- 3 Location for protection modules or the timer module.
- 4 Locking component for metal hold-down clip.
- 5 Locating slot for mounting on DIN rail.
- 6 Two mounting holes for panel mounting.
- 7 Location for bus jumpers (see mounting on sockets on page 38).

(1) The inputs are mixed with the relay coil terminals, with the outputs being located on the opposite side of the socket.

(2) The inputs and outputs are separated from the relay coil terminals.

General characteristics

Conforming to standards			IEC/EN 61810-1 (iss. 2), UL 508, CSA C22-2 n° 14
Product certifications			cULus File E164862 CCN NLDX, NLDX7; cURus File E164862 CCN NLDX2, NLDX8; CSA; CE; RoHS compliant
Ambient air temperature around the device	Storage	°C (F)	-40... +85 (-40... +185)
	Operation	°C (F)	-40... +55 (-40... +131)
Vibration resistance conforming to IEC/EN 60068-2-6	In operation		3 gn (10...150 Hz/± 1 mm / 5g/5 cycles)
	Not operating		4 gn (10...150 Hz/± 1 mm / 5g/5 cycles)
Degree of protection			IP 40
Shock resistance conforming to IEC/EN 60068-2-27	Opening		10 gn
	Closing		10 gn
Protection category			RT I
Mounting position			Any

Insulation characteristics

Rated insulation voltage (Ui)	Conforming to IEC/EN 60947	V	250 (IEC), 300 (UL, CSA)
Rated impulse withstand voltage (Uimp)		kV	4 (1.2/50 μs)
Dielectric strength (rms voltage)	Between coil and contact	~ V	1550
	Between poles	~ V	1550
	Between contacts	~ V	1500

Contact characteristics

Relay type			RUMF2●●●	RUMF3●●●	RUMC2●●●	RUMC3A●●	RUMC3G●●	
Number and type of contacts			2 C/O	3 C/O	2 C/O	3 C/O	3 C/O low level	
Contact materials			AgNi				AgAu	
Conventional thermal current (Ith)	For ambient temperature ≤ 55°C	A	10				3	
Rated operational current in utilization categories AC-1 and DC-1	Conforming to IEC	NO	A	10				2
		NC	A	5				1
	Conforming to UL		A	16 / ~ 277 V 12 / ~ 28 V				3
Switching current	Minimum	mA	10				3	
Switching voltage	Maximum	V	~ 250 (IEC)					
	Minimum	V	17				5	
Nominal load (resistive)		A	10 / 250 ~ V				3 / 250 ~ V	
		A	10 / 28 ~ V				3 / 28 ~ V	
Switching capacity	Maximum	~	VA	2500				750
		~	W	280				84
	Minimum	mW	170				15	
Maximum operating rate In operating cycles/hour	No-load		18 000					
	Under load		1200					
Utilization coefficient			20 %					
Mechanical durability		In millions of operating cycles	5					
Electrical durability In millions of operating cycles	Resistive load		0.1					
	Inductive load		See curves below					

Electrical durability of contacts
Resistive load ~

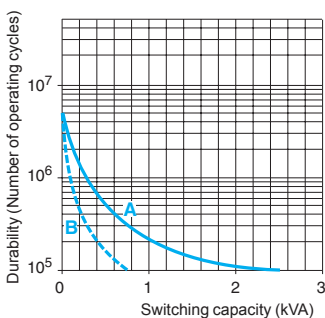

Reduction coefficient for inductive load ~
(depending on power factor cos φ)

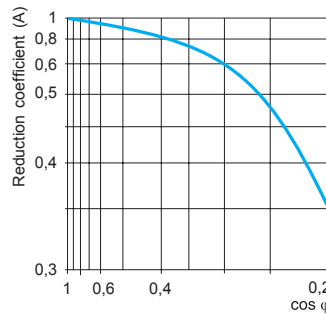

Maximum switching capacity on resistive load ~

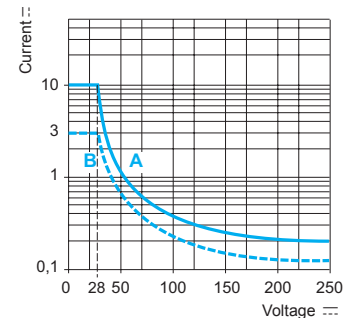

A RUMF●●●●●, RUMC2●●●, RUMC3A●●● **B** RUMC3G●●●

Inductive load durability = resistive load durability x reduction coefficient.

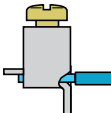
Coil characteristics												
Average consumption		~ 	VA	2...3								
			W	1.4								
Drop-out voltage threshold		~ 		≥ 0.15 Uc								
				≥ 0.1 Uc								
Operating time (response time)	Between coil energization and making of the NO contact	~ 	ms	20								
			ms	20								
	Between coil de-energization and making of the NC contact	~ 	ms	20								
			ms	20								
Control circuit voltage Uc			V	12	24	48	60	110	120	125	220	230
Relay coil voltage codes				JD	BD	ED	ND	FD	–	GD	MD	–
d.c. supply	Average resistance at 20 °C ± 10%		Ω	120	470	1800	2790	10 000	–	10 000	3700	–
	Operating voltage limits	Min.	V	9.6	19.2	38.4	48	88	–	100	176	–
		Max.	V	13.2	26.4	52.8	66	121	–	137.5	242	–
Relay control voltage codes				–	B7	E7	–	–	F7	–	–	P7
a.c. supply	Average resistance at 20 °C ± 15%		Ω	–	72	290	–	–	1700	–	–	7200
	Operating voltage limits	Min.	V	–	19.2	38.4	–	–	96	–	–	184
		Max.	V	–	26.4	52.8	–	–	132	–	–	253
Socket characteristics												
Socket type				RUZC2M	RUZC3M	RUZSC2M	RUZSC3M	RUZSF3M				
Relay types used				RUMC2●●●●●	RUMC3●●●●●	RUMC2●●●●●	RUMC3●●●●●	RUMF●●●●●				
Contact terminal arrangement				Mixed			Separate					
Wire connection method				Connector								
Product certifications				cURus File E172326 CCN SWIV2, SWIV8; CSA; CE; RoHS compliant								
Conforming to standards				IEC 61984, CE								
Electrical characteristics												
Conventional thermal current (I _{th})			A	10			12					
Maximum operating voltage			V	250 (IEC)								
Insulation characteristics												
Between adjacent output contacts			V _{rms}	2500								
Between input and output contacts			V _{rms}	2500								
Between contacts and DIN rail			V _{rms}	2500								
General characteristics												
Ambient air temperature around the device	Operation	°C (F)	- 40...+ 55 (-40... +131)									
	Storage	°C (F)	- 40...+ 85 (-40... +185)									
Degree of protection		Conforming to IEC/EN 60529										
		IP 20										
Connection	Solid wire	1 conductor	0.5...2.5 mm ² - AWG 20...AWG 14									
	without cable end	2 conductors	0.5...1.5 mm ² - AWG 20...AWG 16									
	Flexible wire	1 conductor	0.25...2.5 mm ² - AWG 22...AWG 14									
	with cable end	2 conductors	0.25...1 mm ² - AWG 22...AWG 17									
Maximum tightening torque / Screw size			Nm	1 / M3.3 screw								
Mounting			35 mm DIN rail / panel									
Mounting on DIN rail			By red plastic clip									
Terminal referencing			IEC, NEMA									
Bus jumper (I _{th} : 5 A)			No			Yes						
Compatibility with the metal hold-down clip			Yes									
Timer module			Yes									
Protection module			All RUW24●●●									
Clip-in ID tags			No			Yes						
Wire connection method		Box lug connector										



RUM●●AB1F7



RUM●●AB2F7

Product selection

Relays for standard applications, without LED (sold in lots of 10)

Pins	Control circuit voltage	Number and type of contacts - Thermal current (Ith)				
		2 C/O - 10 A	3 C/O - 10 A			
		Catalog number	Weight	Catalog number	Weight	
	V		kg		kg	
Cylindrical	⋯ 12	RUMC2AB1JD	0.085	RUMC3AB1JD	0.088	
	⋯ 24	RUMC2AB1BD	0.085	RUMC3AB1BD	0.088	
	⋯ 48	RUMC2AB1ED	0.085	RUMC3AB1ED	0.088	
	⋯ 60	–	–	RUMC3AB1ND	0.088	
	⋯ 110	RUMC2AB1FD	0.085	RUMC3AB1FD	0.088	
	⋯ 125	–	–	RUMC3AB1GD	0.088	
	⋯ 220	–	–	RUMC3AB1MD	0.088	
	~ 24	RUMC2AB1B7	0.085	RUMC3AB1B7	0.088	
	~ 48	RUMC2AB1E7	0.085	RUMC3AB1E7	0.088	
	~ 120	RUMC2AB1F7	0.085	RUMC3AB1F7	0.088	
	~ 230	RUMC2AB1P7	0.085	RUMC3AB1P7	0.088	
	Flat (quick-connect)	⋯ 12	RUMF2AB1JD	0.080	RUMF3AB1JD	0.082
		⋯ 24	RUMF2AB1BD	0.080	RUMF3AB1BD	0.082
		⋯ 48	RUMF2AB1ED	0.080	RUMF3AB1ED	0.082
⋯ 110		RUMF2AB1FD	0.080	RUMF3AB1FD	0.082	
~ 24		RUMF2AB1B7	0.080	RUMF3AB1B7	0.082	
~ 48		RUMF2AB1E7	0.080	RUMF3AB1E7	0.082	
~ 120		RUMF2AB1F7	0.080	RUMF3AB1F7	0.082	
~ 230		RUMF2AB1P7	0.080	RUMF3AB1P7	0.082	

Relays for standard applications, with LED (sold in lots of 10)

Cylindrical	⋯ 12	RUMC2AB2JD	0.085	RUMC3AB2JD	0.088	
	⋯ 24	RUMC2AB2BD	0.085	RUMC3AB2BD	0.088	
	⋯ 48	RUMC2AB2ED	0.085	RUMC3AB2ED	0.088	
	⋯ 60	–	–	RUMC3AB2ND	0.088	
	⋯ 110	RUMC2AB2FD	0.085	RUMC3AB2FD	0.088	
	⋯ 125	–	–	RUMC3AB2GD	0.088	
	~ 24	RUMC2AB2B7	0.085	RUMC3AB2B7	0.088	
	~ 48	RUMC2AB2E7	0.085	RUMC3AB2E7	0.088	
	~ 120	RUMC2AB2F7	0.085	RUMC3AB2F7	0.088	
	~ 230	RUMC2AB2P7	0.085	RUMC3AB2P7	0.088	
	Flat (quick-connect)	⋯ 12	RUMF2AB2JD	0.084	RUMF3AB2JD	0.082
		⋯ 24	RUMF2AB2BD	0.084	RUMF3AB2BD	0.082
		⋯ 48	RUMF2AB2ED	0.084	RUMF3AB2ED	0.082
		⋯ 110	RUMF2AB2FD	0.084	RUMF3AB2FD	0.082
~ 24		RUMF2AB2B7	0.084	RUMF3AB2B7	0.082	
~ 48		RUMF2AB2E7	0.084	RUMF3AB2E7	0.082	
~ 120		RUMF2AB2F7	0.084	RUMF3AB2F7	0.082	
~ 230		RUMF2AB2P7	0.084	RUMF3AB2P7	0.082	

Relays with low level contacts, with LED (sold in lots of 10)

Pins	Control circuit voltage	Number and type of contacts Thermal current (Ith)	
		3 C/O - 3 A	
		Catalog number	Weight
	V		kg
Cylindrical	~ 24	RUMC3GB2BD	0.086
	~ 48	RUMC3GB2ED	0.086
	~ 24	RUMC3GB2B7	0.086
	~ 48	RUMC3GB2E7	0.086
	~ 120	RUMC3GB2F7	0.086
	~ 230	RUMC3GB2P7	0.086



RUCZ3M + relais RUMC3



RUW241P7



RUW101MW



RUZC200



RUZS2

Product selection (continued)

Sockets

Contact terminal arrangement	Connection	Relay type	Sold in lots of	Catalog number	Weight kg
Mixed	Box lug connector	RUMC2	10	RUCZ2M	0.054
		RUMC3	10	RUCZ3M	0.054
Separate	Box lug connector	RUMC2	10	RUZSC2M	0.095
		RUMC3	10	RUZSC3M	0.100
		RUMF2	10	RUZSF3M	0.095
		RUMF3			

Protection modules

Description	For use with	Voltage	Sold in lots of	Catalog number	Weight kg
					kg
V					
Diode	All sockets	6...250	10	RUW240BD	0.004
RC circuit	All sockets	110...240	10	RUW241P7	0.004
Varistor	All sockets	24	10	RUW242B7	0.004
		240	10	RUW242P7	0.004

Timer module

Description	For use with	Voltage	Catalog number	Weight kg	
					kg
V					
Multifunction	All sockets	24... 240	RUW101MW	0.020	

Timing relays

Description	For use with	Catalog number	Weight kg
2 timed C/O contacts (single-function or multifunction)	On sockets RUC2M	RE48A (1)	–

Accessories

Description	For use with	Sold in lots of	Catalog number	Weight kg
Metal hold-down clip	All sockets	10	RUZC200	0.001
Bus jumper 2-pole (Ith : 5 A)	All sockets with separate contacts	10	RUZS2	0.005
Clip-in ID tags	All relays (sheet of 108 ID tags)	10	RXZL520	0.080
	All sockets with separate contacts	10	RUZL420	0.001

(1) Please consult the "Zelio Time timing relays" catalog.

Dimensions (mm):

Universal relays

RUMC●●

RUMF●●



Sockets

Common side view

RUZC2M

RUZC3M

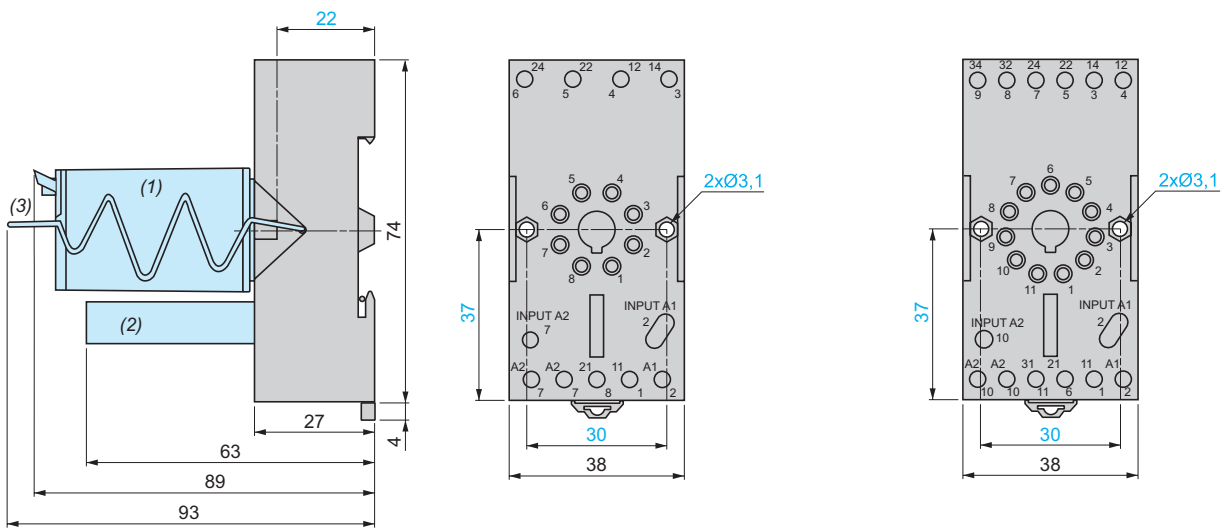

RUZSC2M

RUZSC3M

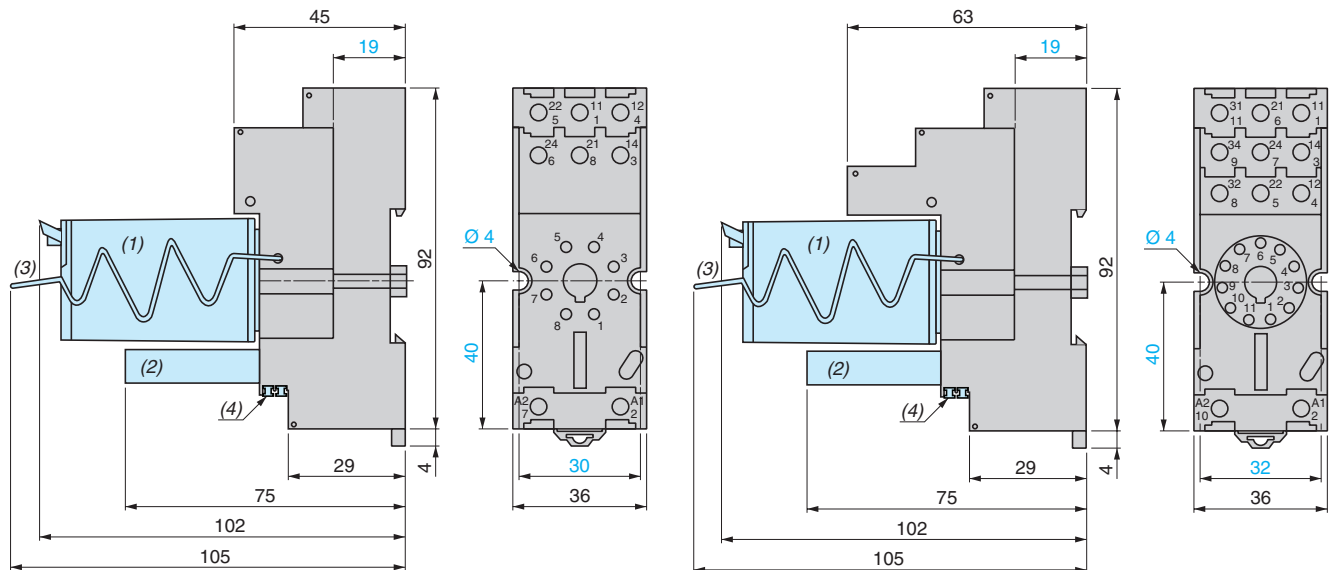

- (1) Relays
- (2) Protection module
- (3) Retention clip
- (4) 2 bus jumpers

Dimensions (mm):

Sockets (continued)

RUZSF3M

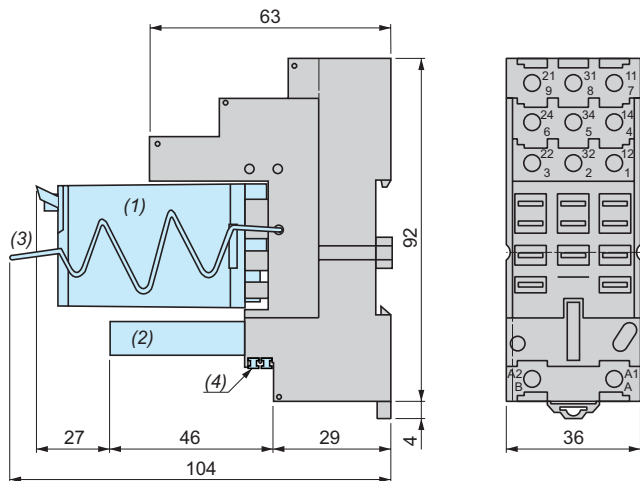

- (1) Relays
- (2) Protection module
- (3) Retention clip
- (4) 2 bus jumpers

Metal hold-down clip and plastic ID tags

RUZC200

Mounting

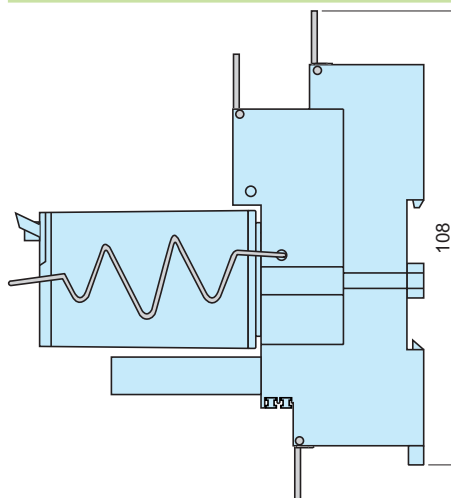
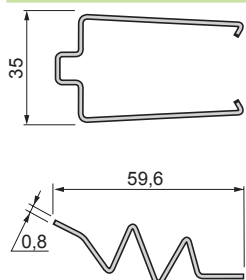

RUZL420

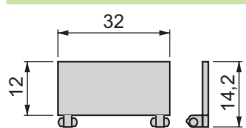

Bus jumper

RUZS2

Mounting on sockets with separate contacts (view from below)

Example of bus jumper mounting on sockets

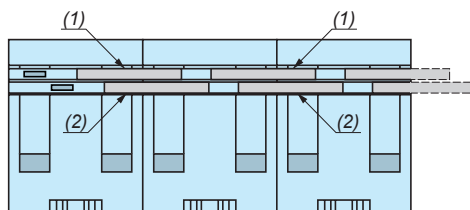
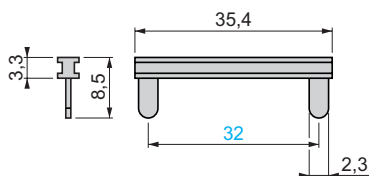

- (1) 2 bus jumpers (polarity A2)
- (2) 2 bus jumpers (polarity A1)

Wiring diagrams

Universal relays

RUM2AB●●●

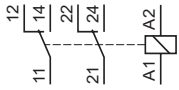

RUMC3●●●●●

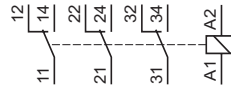

RUMF3AB●●●

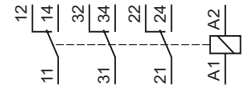

RUMC2AB●●●

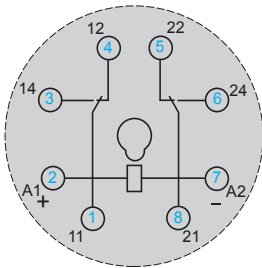

RUMF2AB●●●

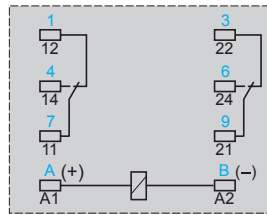

RUMC3●●●●●

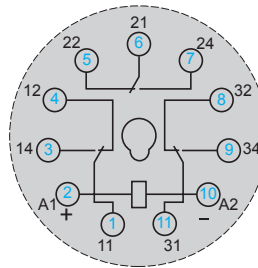

RUMF3AB●●●

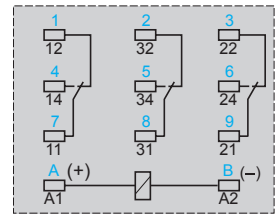

Symbols shown in blue correspond to Nema marking.

Sockets

RUZC2M

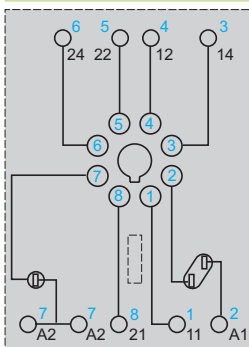

RUZC3M

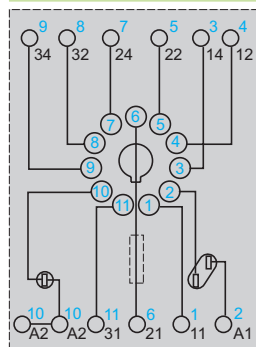

RUZSC2M

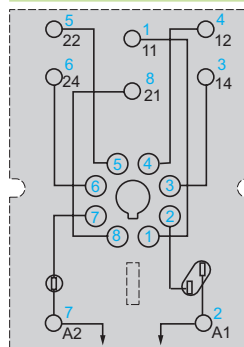

RUZSC3M

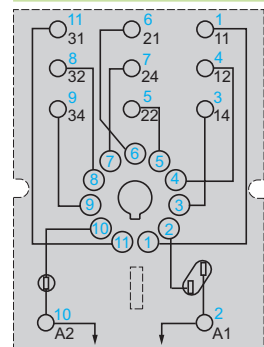

Symbols shown in blue correspond to Nema marking.

RUZSF3M

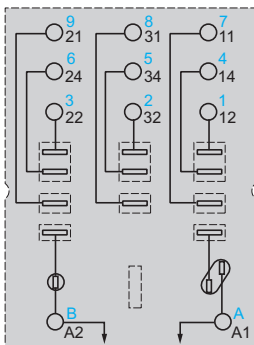

Symbols shown in blue correspond to Nema marking.

Wiring diagrams (continued)

Protection modules

RUW240BD

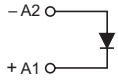

RUW241P7

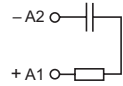

RUW242●●

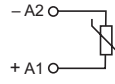

Multifunction timer module RUW101MW

Programming

Timing range selection

Function selection
Timing range selection

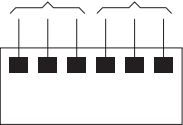

0.1...1 s



0.1...10 s



0.1...1 min



1...10 min



0.1...1 h



1...10 h



0.1...1 day



1...10 days

Function selection

Selection

Function

Control

Function diagram

Control scheme

	On-delay Timer E	Series control		
	Monostable with maintained control Wu	Series control		
	Flashing relay, starting On-delay phase Bi	Series control		
	Flashing relay, starting Off-delay phase Bp	Series control		
	Off-delay timer R	Control by external contact (S)		
	Monostable with pulse control Ws	Control by external contact (S)		
	Monostable, starting on de-energization Wa	Control by external contact (S)		
	On-delay Timer Es	Control by external contact (S)		

Power off

Contact open

U : voltage

S : external control

Power on

Contact closed

R : relay RUM ●●●

t : adjustable time delay

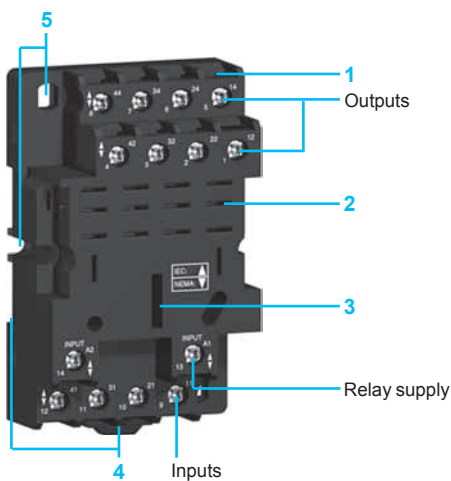
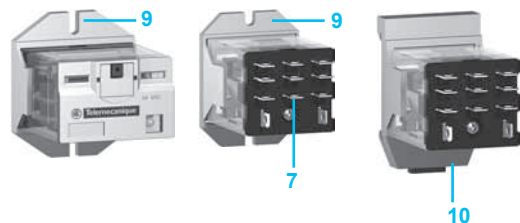
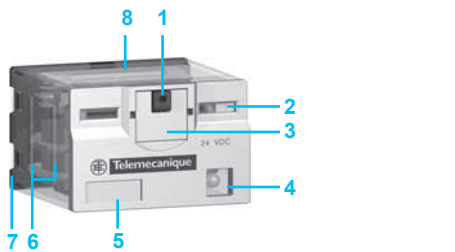
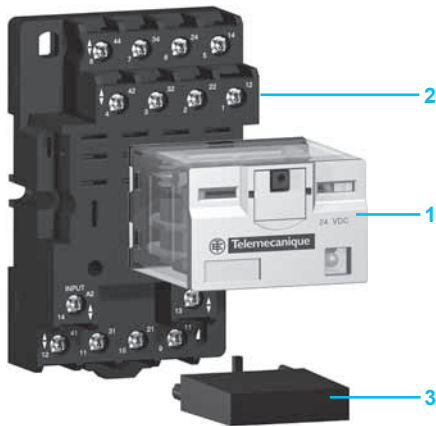

Introduction of the product range

The RPM power relay range includes:

- 1 15 A relays with 1, 2, 3 and 4 C/O (SPDT, DPDT, 3PDT and 4PDT) contacts.
- 2 Sockets with mixed contact terminals.
- 3 Protection modules (diode, RC circuit or varistor) or 1 timer module. Please note that the timer module can only be used with 3-pole or 4-pole sockets.
- 4 Metal hold-down clip for single-contact relays (not shown).

Relay description

- 1 Spring return push-to-test button for checking contact operation (green: —, red: ~).
- 2 Mechanical “relay status” indicator.
- 3 Removable lock-down door enables continuous engagement of the contacts for testing or maintenance purposes. During operation, this lock-down door must always be in the closed position.
- 4 Bipolar LED (depending on version) indicating the relay status.
- 5 Removable ID tag for relay identification.
- 6 Four notches for DIN rail mounting adapter or panel mounting adapter with fixing lugs.
- 7 Five, eight, eleven or fourteen quick-connect pins.
- 8 Area by which the product can be easily gripped.
- 9 Mounting adapter enabling direct mounting of the relay on a panel.
- 10 Mounting adapter enabling direct mounting of the relay on a DIN rail.

Socket description

Sockets with mixed contact terminals (1)

- 1 Connection by screw clamp terminals.
- 2 Five, eight, eleven or fourteen female contacts for the relay pins.
- 3 Location for protection modules or the timer module.
- 4 Locating slot for mounting on DIN rail with mounting clip.
- 5 Two or four mounting holes for panel mounting.

(1) The inputs are mixed with the relay coil terminals, with the outputs being located on the opposite side of the socket.

General characteristics

Conforming to standards			IEC/EN 61810-1 (iss. 2), UL 508, CSA C22-2 n° 14
Product certifications			cULus File E164862 CCN NLDX, NLDX7; cURus File E164862 CCN NLDX2, NLDX8; CSA; CE; RoHS compliant
Ambient air temperature around the device	Storage	°C (F)	-40... +85 (-40... +185)
	Operation	°C (F)	-40... +55 (-40... +131)
Vibration resistance conforming to IEC/EN 60068-2-6	In operation		3 gn (10...150 Hz/± 1 mm / 5g/5 cycles)
	Not operating		5 gn (10...150 Hz/± 1 mm / 5g/5 cycles)
Degree of protection conforming to IEC/EN 60529			IP 40
Shock resistance conforming to IEC/EN 60068-2-27	Opening		15 gn
	Closing		15 gn
Protection category			RT I
Mounting position			Any

Insulation characteristics

Rated insulation voltage (Ui)	Conforming to IEC/EN 60947	V	250 (IEC), 300 (UL, CSA)
Rated impulse withstand voltage (Uimp)		kV	4 (1.2/50 μs)
Dielectric strength (rms voltage)	Between coil and contact	~ V	1550
	Between poles	~ V	1550
	Between contacts	~ V	1500

Contact characteristics

Relay type			RPM1●●●	RPM2●●●	RPM3●●●	RPM4●●●
Number and type of contacts			1 C/O	2 C/O	3 C/O	4 C/O
Contact materials			AgNi			
Conventional thermal current (Ith)	For ambient temperature ≤ 55 °C	A	15			
Rated operational current in utilization categories AC-1 and DC-1	Conforming to IEC	NO	A	15		
		NC	A	7.5		
	Conforming to UL		A	15		
Switching current	Minimum	mA	10			
Switching voltage	Maximum	V	~ / --- 250 (IEC)			
	Minimum	V	17			
Nominal load (resistive)		A	15 / 250 ~ V			
		A	15 / 28 --- V			
Switching capacity	Maximum	~	VA	3750		
		---	W	420		
	Minimum	mW	170			
Maximum operating rate In operating cycles/hour	No-load		18 000			
	Under load		1200			
Utilization coefficient			20 %			
Mechanical durability	In millions of operating cycles		10			
Electrical durability In millions of operating cycles	Resistive load		0.1			0.06
	Inductive load		See curves below			

Electrical durability of contacts
Resistive load ~

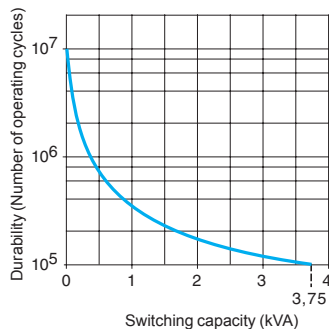

Reduction coefficient for inductive load ~
(depending on power factor cos φ)

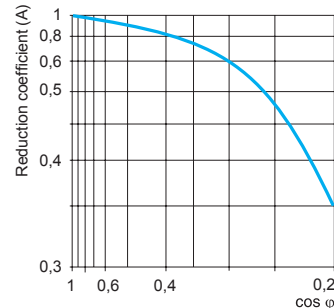

Maximum switching capacity on resistive load ---

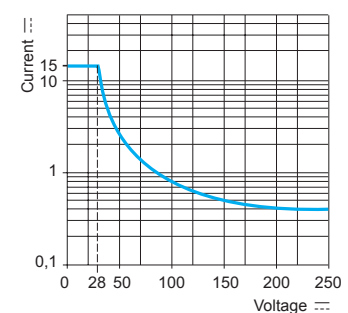

Inductive load durability = resistive load durability x reduction coefficient.

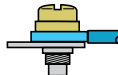
Coil characteristics				RPM1●●●	RPM2●●●	RPM3●●●	RPM4●●●		
Relay type		~	VA	0.9	1.2	1.5	1.5		
Average consumption		≡	W	0.7	0.9	1.7	2		
Drop-out voltage threshold		~		≥ 0.15 U _c					
		≡		≥ 0.1 U _c					
Operating time (response time)	Between coil energization and making of the NO contact	~	ms	20	25	25	20		
		≡	ms	20	25	25	20		
	Between coil de-energization and making of the NC contact	~	ms	20					
		≡	ms	20					
Control circuit voltage U _c			V	12	24	48	110	120	230
Relay control voltage codes				JD	BD	ED	FD	-	-
d.c. supply	Average resistance at 20 °C ± 10%	RPM1●●●	Ω	180	750	2600	13 100	-	-
		RPM2●●●	Ω	160	650	2600	11 000	-	-
		RPM3●●●	Ω	100	400	2600	8600	-	-
		RPM4●●●	Ω	96	388	1550	7340	-	-
	Operating voltage limits	Min.	V	9.6	19.2	38.4	88	-	-
		Max.	V	13.2	26.4	52.8	121	-	-
Relay control voltage codes				-	B7	E7	-	F7	P7
a.c. supply	Average resistance at 20 °C ± 15%	RPM1●●●	Ω	-	160	720	-	4430	15 720
		RPM2●●●	Ω	-	180	770	-	4430	15 000
		RPM3●●●	Ω	-	103	770	-	2770	12 000
		RPM4●●●	Ω	-	84.3	338	-	2220	9120
	Operating voltage limits	Min.	V	-	19.2	38.4	-	96	184
		Max.	V	-	26.4	52.8	-	132	253
Socket characteristics				RPZF1	RPZF2	RPZF3	RPZF4		
Socket type				RPM1●●●	RPM2●●●	RPM3●●●	RPM4●●●		
Relay types used				RXM02●●●	RXM04●●●	RUW24●●●	RUW24●●●		
Protection module types used				RXM02●●●	RXM04●●●	RUW24●●●	RUW24●●●		
Contact terminal arrangement				Mixed					
Wire connection method				Screw clamp terminals					
Product certifications				cURus File E172326 CCN SWIV2, SWIV8; CSA; CE; RoHS compliant					
Conforming to standards				IEC 61984, CE					
Electrical characteristics									
Conventional thermal current (I _{th})		A		16					
Maximum operating voltage		V		250 (IEC)					
Insulation characteristics									
Between adjacent output contacts		V _{rms}		2500					
Between input and output contacts		V _{rms}		2500					
Between contacts and DIN rail		V _{rms}		2500					
General characteristics									
Ambient air temperature around the device	Operation	°C		- 40...+ 55					
	Storage	°C		- 40...+ 85					
Degree of protection		Conforming to IEC/EN 60529		IP 20					
Connection	Solid wire	1 conductor		0.5...1.5 mm ² - AWG 20...AWG 16	0.5...2.5 mm ² - AWG 20...AWG 14				
		2 conductors		0.5...1.5 mm ² - AWG 20...AWG 16	0.5...2.5 mm ² - AWG 20...AWG 14				
	Flexible wire with cable end	1 conductor		0.25...1 mm ² - AWG 22...AWG 17	0.25...1.5 mm ² - AWG 22...AWG 16				
		2 conductors		0.25...1 mm ² - AWG 22...AWG 17	0.25...1.5 mm ² - AWG 22...AWG 16				
Maximum tightening torque / Screw size		Nm		1 / M3 screw		1 / M3.5 screw			
Mounting				35 mm DIN rail / panel mount					
Mounting on DIN rail				By red plastic clip					
Terminal referencing				IEC, NEMA					
Compatibility with the metal hold-down clip				Yes		No			
Timer module compatibility				No			Yes		
Protection module				RXM040W, RXM041●●, RXM021●●			RUW24●●		
Clip-in ID tags				No					
Wire connection method		Screw clamp terminals							



RPM41BD

Power relays without LED (sold in lots of 10)								
Control circuit voltage	Number and type of contacts - Thermal current (Ith)							
	1 C/O - 15 A		2 C/O - 15 A		3 C/O - 15 A		4 C/O - 15 A	
	Catalog number	Weight	Catalog number	Weight	Catalog number	Weight	Catalog number	Weight
V		kg		kg		kg		kg
⎓ 12	RPM11JD	0.026	RPM21JD	0.036	RPM31JD	0.054	RPM41JD	0.071
⎓ 24	RPM11BD	0.026	RPM21BD	0.036	RPM31BD	0.054	RPM41BD	0.071
⎓ 48	RPM11ED	0.026	RPM21ED	0.036	RPM31ED	0.054	RPM41ED	0.071
⎓ 110	RPM11FD	0.026	RPM21FD	0.036	RPM31FD	0.054	RPM41FD	0.071
~ 24	RPM11B7	0.026	RPM21B7	0.036	RPM31B7	0.054	RPM41B7	0.071
~ 48	RPM11E7	0.026	RPM21E7	0.036	RPM31E7	0.054	RPM41E7	0.071
~ 120	RPM11F7	0.026	RPM21F7	0.036	RPM31F7	0.054	RPM41F7	0.071
~ 230	RPM11P7	0.026	RPM21P7	0.036	RPM31P7	0.054	RPM41P7	0.071



RPM42BD

Power relays with LED (sold in lots of 10)								
Control circuit voltage	Number and type of contacts - Thermal current (Ith)							
	1 C/O - 15 A		2 C/O - 15 A		3 C/O - 15 A		4 C/O - 15 A	
	Catalog number	Weight	Catalog number	Weight	Catalog number	Weight	Catalog number	Weight
V		kg		kg		kg		kg
⎓ 12	RPM12JD	0.026	RPM22JD	0.036	RPM32JD	0.054	RPM42JD	0.071
⎓ 24	RPM12BD	0.026	RPM22BD	0.036	RPM32BD	0.054	RPM42BD	0.071
⎓ 48	RPM12ED	0.026	RPM22ED	0.036	RPM32ED	0.054	RPM42ED	0.071
⎓ 110	RPM12FD	0.026	RPM22FD	0.036	RPM32FD	0.054	RPM42FD	0.071
~ 24	RPM12B7	0.026	RPM22B7	0.036	RPM32B7	0.054	RPM42B7	0.071
~ 48	RPM12E7	0.026	RPM22E7	0.036	RPM32E7	0.054	RPM42E7	0.071
~ 120	RPM12F7	0.026	RPM22F7	0.036	RPM32F7	0.054	RPM42F7	0.071
~ 230	RPM12P7	0.026	RPM22P7	0.036	RPM32P7	0.054	RPM42P7	0.071



RPZF2 + relay RPM22F7



RUW24...



RPZ1DA



RPZ3FA

Sockets					
Contact terminal arrangement	Connection	Relay type	Sold in lots of	Catalog number	Weight kg
Mixed	Screw clamp terminals	RPM1●●●	10	RPZF1	0.042
		RPM2●●●	10	RPZF2	0.054
		RPM3●●●	10	RPZF3	0.072
		RPM4●●●	10	RPZF4	0.094

Protection modules					
Description	Voltage	Socket type	Sold in lots of	Catalog number	Weight kg
V					
Diode	--- 6...250	RPZF1RPZ F2	20	RXM040W	0.003
		RPZF3 RPZF4	10	RUW240BD	0.004
RC circuit	~ 24...60	RPZF1RPZ F2	20	RXM041BN7	0.010
	~ 110...240	RPZF1RPZ F2	20	RXM041FU7	0.010
Varistor	~--- 6...24	RPZF1RPZ F2	20	RXM021RB	0.030
		RPZF1RPZ F2	20	RXM021BN	0.030
	~--- 110...240	RPZF1RPZ F2	20	RXM021FP	0.030
	~--- 24	RPZF3 RPZF4	10	RUW242B7	0.004
	~--- 240	RPZF3 RPZF4	10	RUW242P7	0.004

Timer module (1)					
Description	Voltage	Socket type		Catalog number	Weight kg
V					
Multifunction	~--- 24... 240	RPZF3 RPZF4		RUW101MW	0.020

Accessories					
Description	For use with	Sold in lots of	Catalog number	Weight kg	
Metal hold-down clip (for single-pole relays)	RPZF1	20	RPZR235	0.001	
Mounting adapters for DIN rail (2)	RPM1●●●	20	RPZ1DA	0.004	
	RPM2●●●	20	RXZE2DA	0.004	
	RPM3●●●	20	RPZ3DA	0.004	
	RPM4●●●	20	RPZ4DA	0.006	
Mounting adapters with fixing lugs for panel	RPM1●●●	20	RPZ1FA	0.002	
	RPM2●●●	20	RXZE2FA	0.002	
	RPM3●●●	20	RPZ3FA	0.003	
	RPM4●●●	20	RPZ4FA	0.004	
Clip-in ID tags (sheet of 108 ID tags)	All relays	10	RXZL520	0.080	

(1) See timer module description (selection of functions and time delays) on page 41

(2) Test button becomes inaccessible.

Dimensions (mm):

Power relays

RPM 1

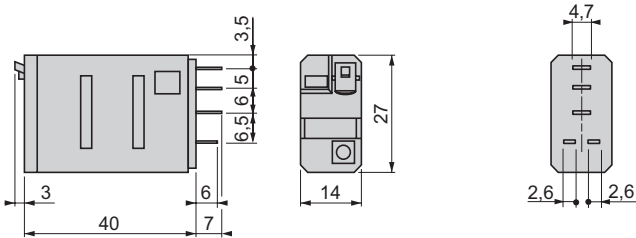

Common side view

RPM2

RPM 3

RPM 4

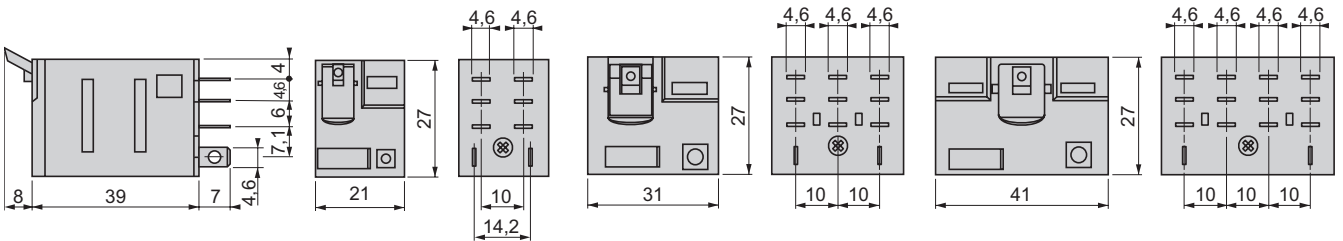

Sockets

RPZF1

RPZF2

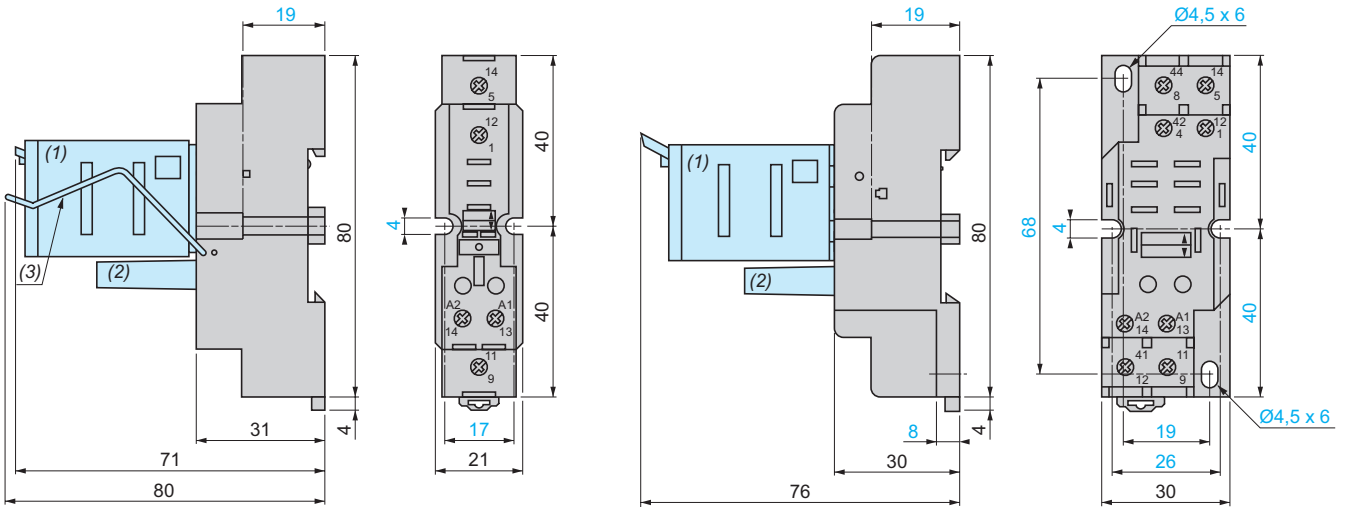

Common side view

RPZF3

RPZF4

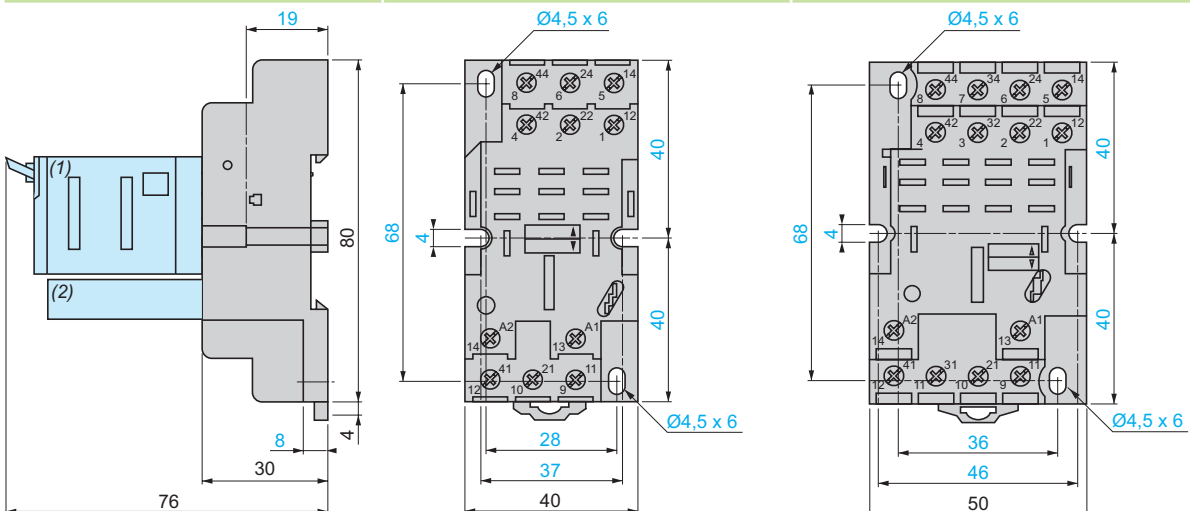

- (1) Relays
- (2) Protection module
- (3) Retention clip

Dimensions (mm):

Mounting adapters for DIN rail

RPZ1DA

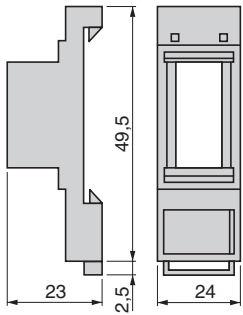

RXZE2DA

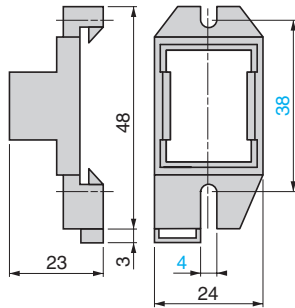

RPZ3DA

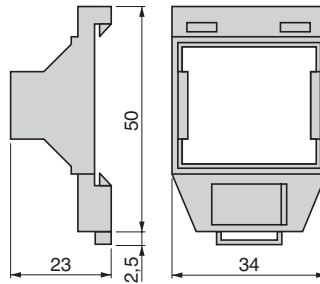

RPZ4DA

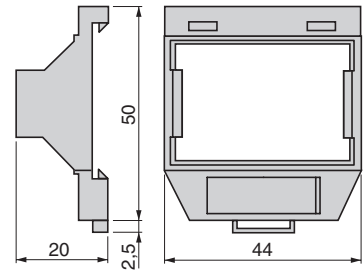

Mounting adapters with fixing lugs for panel

RPZ1FA

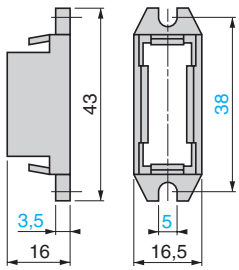

RXZE2FA

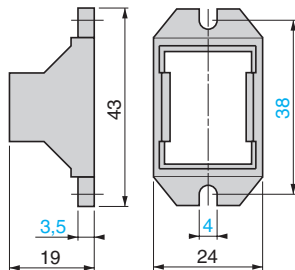

RPZ3FA

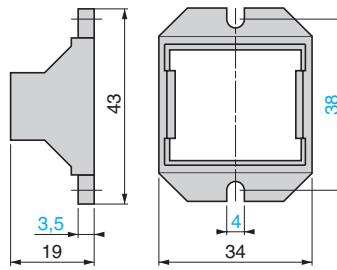

RPZ4FA

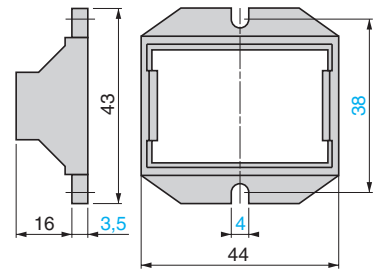

Mounting

Mounting adapters for DIN rail (1)

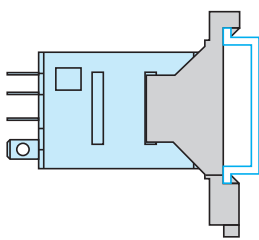

Mounting adapters with fixing lugs for panel

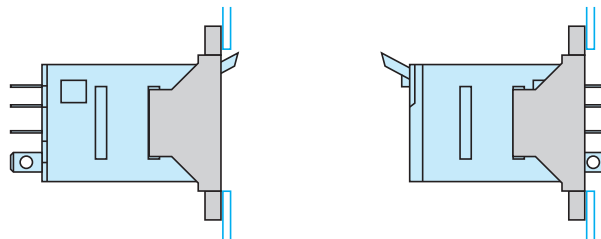

(1) Test button becomes inaccessible

Wiring diagrams

Power relays

RPM1●●●

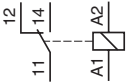

RPM2●●●

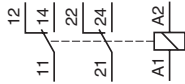

RPM3●●●

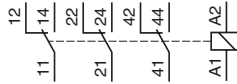

RPM4●●●

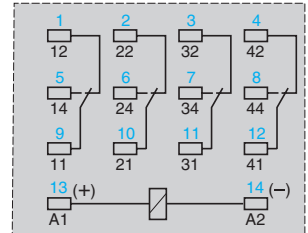
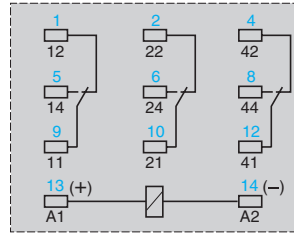
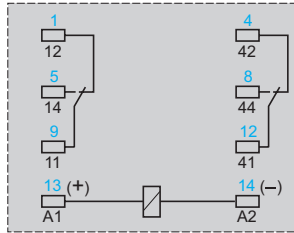
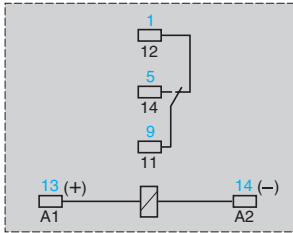
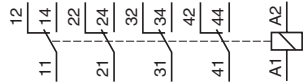

Symbols shown in blue correspond to Nema marking.

Sockets

RPZF1

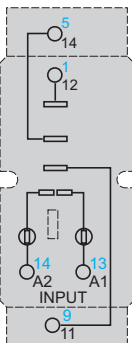

RPZF2

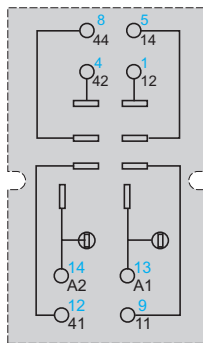

RPZF3

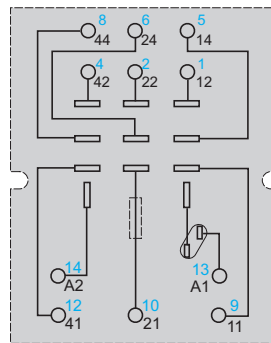

RPZF4

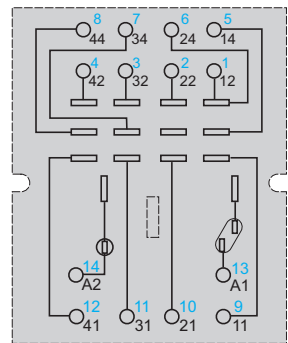

Symbols shown in blue correspond to Nema marking.

Protection modules

RXM040W, RUW240BD

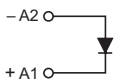

RXM041●●●, RUW241P7

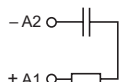

RXM021●●●, RUW242●●

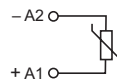

Introduction of the product range

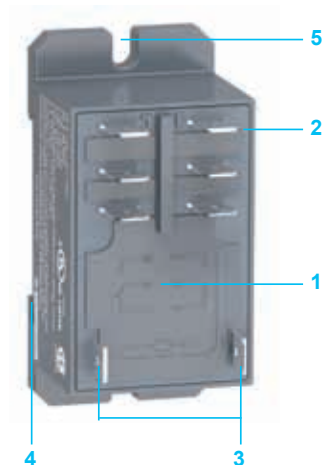

- 1 30 A relays with 2 C/O or 2 N/O contacts
- 2 Four or six quick-connect terminals
- 3 Two relay coil terminals
- 4 A locating slot for DIN rail mounting
- 5 Two holes for optional panel mounting

General specifications

Conformity to standards			IEC/EN 61810-1, UL 508, CSA C22-2 n°14
Product certifications and standards			UL listed, CSA, CE, GOST, RoHS
Ambient air temperature around the device	Storage	°C (°F)	- 40 to + 85 (-40 to +185)
	Operation	°C (°F)	- 40 to + 55 (-40 to + 131)
Vibration resistance conforming to EC/EN 60068-2-6	In operation		3 gn (+/- 1 mm, 10 to 150 Hz) 5 cycles
	Not in operation		10 gn (+/- 1 mm, 10 to 150 Hz) 5 cycles
Degree of protection	Conforming to IEC/EN 60529		IP 40
Shock resistance conforming to IEC/EN 60068-2-27	In operation		10 gn
	Not in operation		30 gn
Protection category			RT II
Pollution degree			3
Mounting position			Any

Insulation specifications

Rated insulation voltage (Ui)		V	250 (conforming to IEC)
		V	300 (conforming to UL)
Rated impulse withstand voltage (Uimp)		kV	4 (1.2 μs / 50 μs)
Dielectric strength (rms voltage)	Between coil and contact	Vac	4000 (reinforced insulation)
	Between poles	Vac	2000 (basic insulation)
	Between contacts	Vac	1500 (micro-disconnection)

Contact specifications			RPF 2A●●	RPF 2B●●
Relay type			2 N/O	2 C/O
Number and type of contacts			AgSnO ₂	
Conventional thermal current (I _{th})	For ambient temperature ≤ 40°C	30 A at 28 Vdc / 250 Vac (when mounted with 13 mm gap between two relays) 25 A at 28 Vdc / 250 Vac (when mounted side by side without a gap)		
Rated operational current	Conforming to IEC	N.O.	30 A at 250 Vac; 30 A at 28 Vdc	
		N.C.	3 A at 250 Vac; 3 A at 28 Vdc	
	Conforming to UL	N.O.	General Use: 30 A at 277 Vac Resistive: 20 A at 28 Vdc Motor: 1.0 hp at 120 Vac; 3.0 hp at 240 Vac LRA/FLA: 96 A / 22 A @ 240 Vac (AC coil), 30,000 cycles 10 A / 25.3 A @ 240 Vac (DC coil), 30,000 cycles Pilot Duty: 720 VA / A 300, 6000 cycles Short Circuit: 5000 A rms @ 3 hp, 240 Vac Tungsten: 10 A at 120 Vac 50/60 Hz, 25,000 cycles 6 A at 250 Vac 50/60 Hz, 25000 cycles	
		N.C.	Resistive: 3 A at 277 Vac (6000 cycles); 3 A at 28 Vdc	
Minimum switching current			10 mA	
Minimum switching voltage			17 V	
Maximum switching voltage			250 Vac / Vdc (conforming to IEC)	
Switching capacity	Maximum	7500 VA / 840 W (when mounted with 13 mm gap between two relays) 6250 VA / 700 W (when mounted side by side without a gap)		
	Minimum	170 mW		
Maximum operating rate	No load	18,000 cycles per hour		
	Under load	1200 cycles per hour		
Utilization coefficient			10 %	
Mechanical durability			50,000,000 cycles	
Electrical durability	Resistive load	100,000 cycles, unless otherwise specified under rated operational current		
	Inductive load	See curves below		

Electrical durability of contacts

Resistive load	AC reduction coefficient for inductive load (depending on power factor cos φ) Durability (inductive load) = durability (resistive load) x reduction coefficient.	Maximum switching capacity on DC resistive load
----------------	---	---

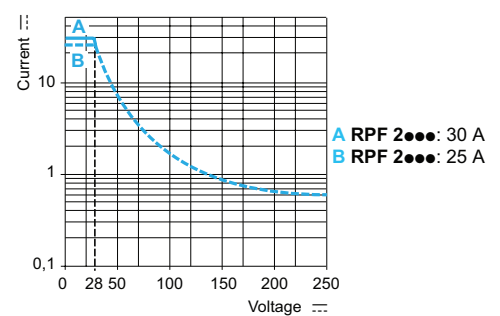
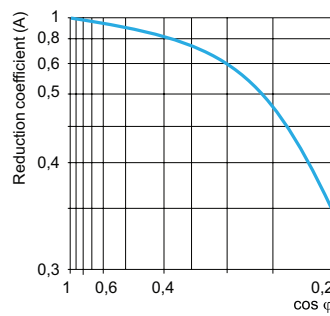
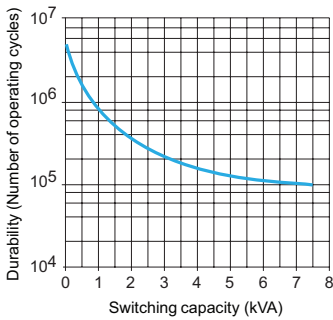

Note: These curves are for reference only and are typical values only. Actual performance is dependant upon the actual load, environment, duty cycle, and other conditions specific to the application.

Coil specifications

Average consumption	VA	4							
	W	1.7							
Drop-out voltage threshold	V _{ac}	≥ 0.15 U _c							
	V _{dc}	≥ 0.1 U _c							
Operating time (response time)	Between coil energization and making of the On-delay contact	ms	25 (max.)						
	Between coil de-energization and making of the Off-delay contact	ms	25 (max.)						
Control circuit voltage U _c	V	12	24	110	120	230			
Relay control voltage codes		JD	BD	FD	—	—			
DC supply	Average resistance at 20 °C ± 10%	Ω	86	350	7255	—	—		
		Operating voltage limits	Min.	V _{dc}	9.6	19.2	88	—	—
		Max.	V _{dc}	13.2	26.4	121	—	—	
Relay control voltage codes		—	B7	—	F7	P7			
AC supply	Average resistance at 20 °C ± 15%	Ω	—	170	—	4250	15,600		
		Operating voltage limits	Min.	V _{ac}	—	19.2	—	96	184
		Max.	V _{ac}	—	26.4	—	132	253	
Contractual warranty period		18 months							

Zelio™ Plug-In Relays

RPF power relays



Power relays (sold in lots of 10)			
Control circuit voltage (V)	Number and type of contacts – Thermal current (Ith)		Weight kg (lbs)
	2 N/O - 30 A (1)	2 C/O - 30 A (1)	
	Catalog number	Catalog number	
12 Vdc	RPF2AJD	RPF2BJD	0.082 (0.181)
24 Vdc	RPF2ABD	RPF2BBD	0.082 (0.181)
110 Vdc	RPF2AFD	RPF2BFD	0.082 (0.181)
24 Vac	RPF2AB7	RPF2BB7	0.082 (0.181)
120 Vac	RPF2AF7	RPF2BF7	0.082 (0.181)
230 Vac	RPF2AP7	RPF2BP7	0.082 (0.181)

(1) 30 A when mounted with 13 mm gap between two relays and 25 A when mounted side by side without a gap.

Dimensions: mm (inches)

Power relays

RPF 2A●●

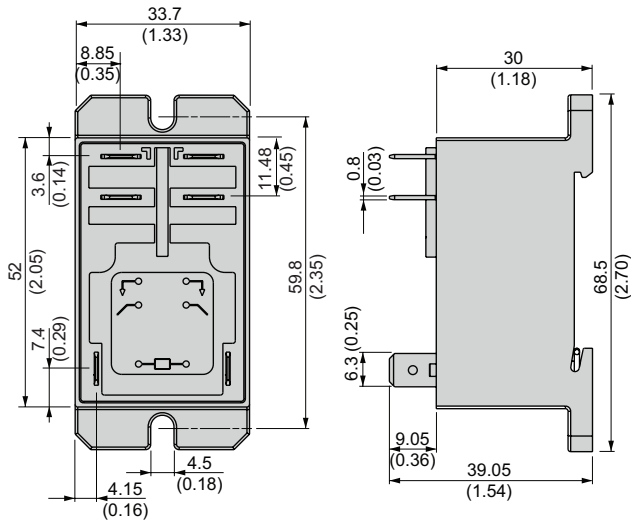

RPF 2B●●

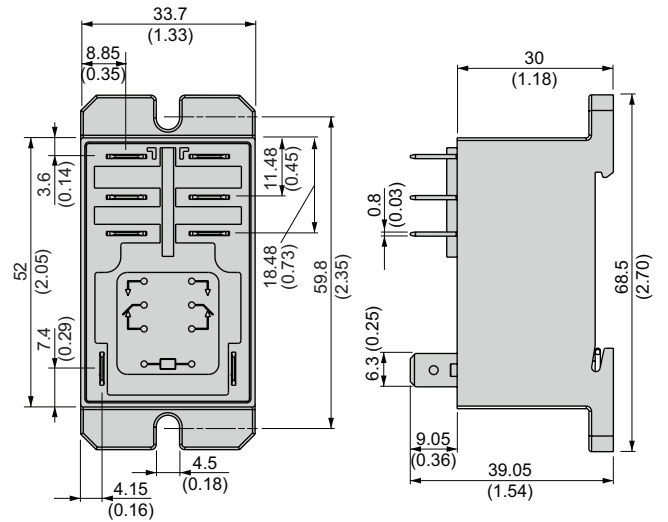

Wiring diagrams

Power relays

RPF 2A●●

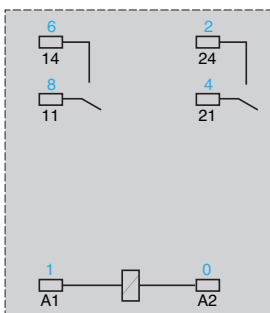

RPF 2B●●

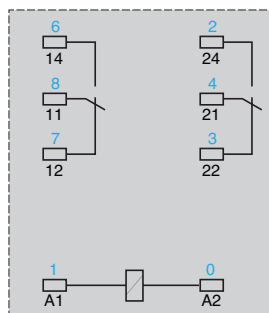

Symbols shown in blue correspond to NEMA marking; symbols shown in black correspond to IEC marking.

Applications

Electromechanical interface modules



Functions

Input

Width (mm)

17.5	9.5
------	-----

Contact arrangement

1 N/O 2 N/O 1 C/O	1 N/O
-------------------------	-------

Thermal current

–

Control voltages

$\overline{\sim}$ 110...127 V \sim 24 V, 48 V \sim 115...127 V \sim 230/240 V	$\overline{\sim}$ 24 V, 48 V \sim 115...127/50 Hz \sim 115...127/60 Hz \sim 230...240/50-60 Hz
--	---

Indication

Mechanical for contacts and/or LED for control	LED for control
--	-----------------

Product numbers

ABR1E	ABR2E
--------------	--------------

Pages

56	62
----	----

Solid state interface modules



Output		Input and output Very low level switching		Input	Output
17.5	12	17.5	9.5	9.5/17.5	
1 N/O 2 N/O 1 C/O 1 N/C + 1 N/O	1 N/O	1 C/O	-		
12 A	5 A	-		5 A	
⎓ 24 V ~ 24 V, 48 V ~ 115...127 V ~ 110 V	⎓ 24 V		⎓ 5, 24, 48 V ~ 115...127/50 Hz ~ 120...127/60 Hz ~ 230...240/50 Hz ~ 230...240/60 Hz	⎓ 24 V	
Mechanical for contacts and/or LED for control	LED for control				
ABR1S	ABR2S	ABR2●B312B	ABS2E	ABS2S	
56	62	62	68		

Interfaces

For discrete signals

Electromechanical interface modules

ABR-1 electromechanical interface modules are supplied in the form of compact modules, 17.5 mm wide.

They are designed for interfacing discrete digital control signals exchanged within an automated system between the processing unit (PLC, numerical controller, etc) and the other components (contactors, solenoid valves, indicator lamps, proximity sensors, etc).

These products are based on advanced contactor technology and are easily adapted to industrial environments. They conform to the most recent IEC 947-5-1 standards.

Composition

The ABR-1 range includes 2 families:

Input interfaces

Input interfaces are designed for switching input signals to the processor and are characterized by their advanced contact reliability: less than 1 interruption per 100 million operating cycles at $\approx 17 \text{ V}, 5 \text{ mA}$.

The switching level is sufficiently high to help ensure that the interfaces can directly control most contactors and indicator lamps.

Output interfaces

Output interfaces are designed for the control of preactuators (contactors, solenoid valves, etc) for signalling devices (indicators lamps, audible warnings, etc). They are characterized by a high switching capacity and an average durability 5 times greater than that of traditional interface modules, which incorporate standard relays.

- 1 Override contacts by pressing button (not holding it down) for a simple and quick test during installation or maintenance operations on the installation
- 2 Green indicator showing the mechanical position of the contacts
- 3 LED indicating the control signal state
- 4 Channel identification : 5 individual characters for AB1-R/G or one AB1-SA2 marker tag
- 5 Connection by screw clamp terminal enabling easy attachment of 2 wires per terminal. The layout of the connection terminals for both families (input and output) is designed for rational wiring and a clear separation between the incoming (processing) and outgoing (power and process control) circuits.

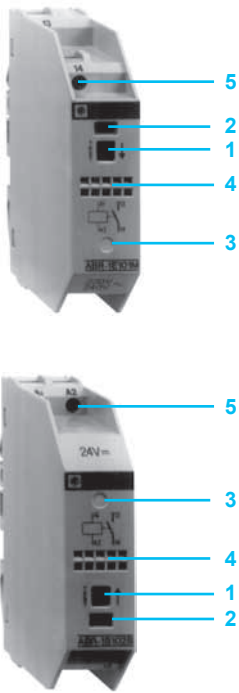

Examples of applications with PLCs

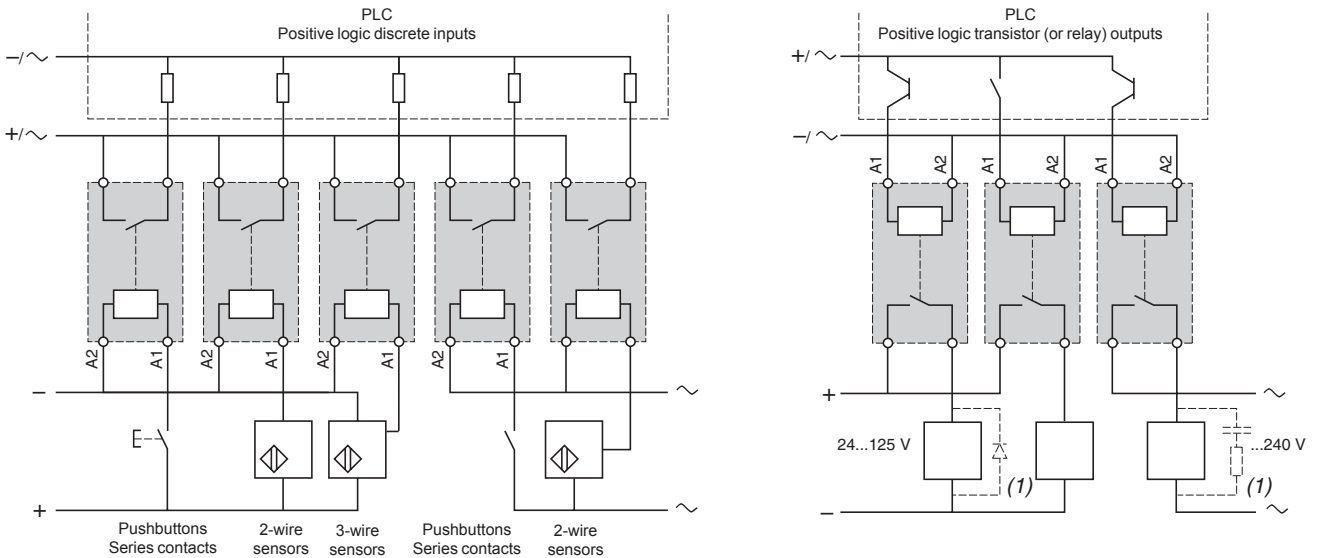

(1) Essential on inductive loads (can be replaced with peak limiter).

Environment

Conforming to standards				IEC 60947-1, UL 508, CSA C22.2 No. 14	
Product certifications				UL, CSA, BV, LROS, DNV	
Degree of protection	Conforming to IEC 529 (protection against direct contact)			IP 00	
Protective treatment				"TC"	
Flame resistance	Conforming to IEC 695-2-1	Incandescent wire	°C	850	
		Conforming to UL 94		V0	
Shock resistance	Conforming to IEC 68-2-27	Semi-sinusoidal waves 11 ms		50 gn	
Vibration resistance	Conforming to IEC 68-2-6	10...55 Hz		6 gn	
Resistance to electrostatic charges	Conforming to IEC 801-2	Level 3	kV	8	
Resistance to rapid transients	Conforming to IEC 801-4	On power supply	kV	2	
		On I/O	kV	1	
Resistance to shock waves	Conforming to IEC 255-4	Waveform 1.2/50 ms ; 0.5 J	U ≤ 50 V	kV	0.5
			U > 50 V	kV	2.5
Cross-sections which may be connected	Flexible wire with no cable end	1 or 2-wire	mm ²	0.6...2.5	
	Flexible wire with cable end	1 or 2-wire	mm ²	0.34...2.5	
	Rigid cable	1-wire	mm ²	0.27...4	
2-wire		mm ²	0.27...2.5		
Operating position				Any	
Ambient air temperature around the device	Unrestricted operation		°C	-5...+40	
	Permissible at Un		°C	-20...+60	
	Storage		°C	-40...+70	
Operating altitude				m	≤ 3000
Installation category	Conforming to IEC 947-1			II	
Degree of pollution	Conforming to IEC 947-5-1			3	
Mounting				Standard DIN rails	

Control circuit characteristics (40°C ambient temperature)

Type of interface		ABR 1S●02B	ABR 1●●●8B	ABR 1●●●8E	ABR 1E●12F	ABR 1●●●1F	ABR 1E●11M	ABR 1E●01M
Rated voltage (Uc)	V	--- 24	~ 24	~ 48	--- 110...127	~ 115...127	~ 230...240	~ 230...240
Current frequency	Hz	–	50/60	50/60	–	50/60	50/60	50/60
Energization threshold (at ± 5 %)	V	15	16.5	34	75	86	170	164
Maximum operating voltage	--- / ~	30	30	53	140	140	264	264
Maximum drop-out (at ± 5 %) voltage (Uo)	--- / ~	3.2	3.8	8.5	16	34	68	78
Maximum current (Un)	--- / ~	62	62/55	36/32	15	8	7	5.5
Minimum holding current	--- / ~	6.6	4.9/5.2	4.7/5.4	1.5	2.4	2	1.5
Maximum dissipated power	50 Hz/60 Hz	W	1.5	1.5	1.5	1.5	1.5	1.5
Disappearance of voltage maximum time up to which contact is maintained	ms	3	8	10	10	6	5	6
Display of control circuit by LED		No	Yes	Yes	Yes	Yes	Yes	No
Built-in protection reversed polarity		Yes	Yes	Yes	Yes	–	–	–

Contact characteristics

Type of interface		ABR1E●●●●	ABR1S●●●●
Maximum switching voltage	~ V	252	252
	--- V	125	125
Maximum rated operating voltage Ue	~ V	230	230
	--- V	125	125
Operating current frequency	Hz	50/60	50/60
Thermal current Ith	Conforming to IEC 947-1	A	2
Rated operating current (Ie) per 1 million operating cycles	Conforming to IEC 947-5-1	AC12	A
	Ue : ~ 230 V	AC13	A
		AC14	A
		AC15	A
	Conforming to IEC 947-5-1	DC12	A
	Ue : --- 24 V	DC13	A
Minimum switching capacity	mA	3	3
Minimum switching voltage	V	17	17
Protection against short-circuits	For I _k ≤ 2.5 kA (~) and ≤ 100 A (---) Type and value of recommended fuse	A	gG/gF : 16
Low power switching performance of contacts (17 V - 5 mA)	Number of interruptions per "n" million operating cycles		10 ⁻⁸

Other characteristics

Operating time at Un and at 20 °C	Between energization of coil and closing of N/O contact	ms	≤ 12
	Between energization of coil and opening of N/C contact	ms	≤ 12
	Between de-energization of coil and opening of N/O contact	ms	≤ 12
	Between de-energization of coil and closing of N/C contact	ms	≤ 12
Duration of bounce		ms	≤ 3
Contact bridging times between contact "N/C" and "N/O"	Maximum make before break or break before make time	ms	1
Maximum operating rate	At no-load	Hz	6
	At Ie	Hz	0.5
Mechanical durability in millions of operating cycles	ABR-1 (1 N/O or 2 N/O)		≥ 20 million
	ABR-1 (1 C/O or 1 N/C + 1 N/O)		≥ 10 million
Rated isolation voltage	Conforming to IEC 947-1	V	250
	Conforming to VDE 0110 group C	V	250
Insulation test voltage for 1 min.	Between coil circuit and contact circuits	kV	4
	Between wired interface and ground	kV	2.5
	Between independent contacts	kV	1.5

Electrical durability of contacts

Test conditions : in accordance with standard IEC 947-5-1 set up for rated control voltage, operating rate : 1800 cycles/hour. (0.5 Hz).

a.c. loads

Operating cycles in millions

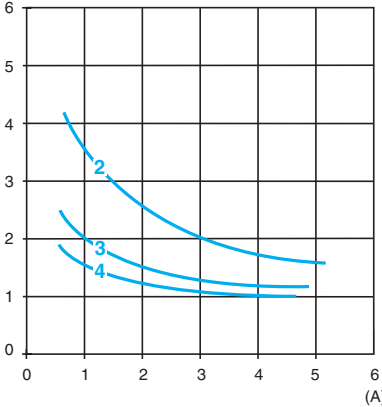

AC-12 : control of resistive loads and isolated solid state loads via optocoupler
 $\cos \varphi \geq 0.9$

Operating cycles in millions

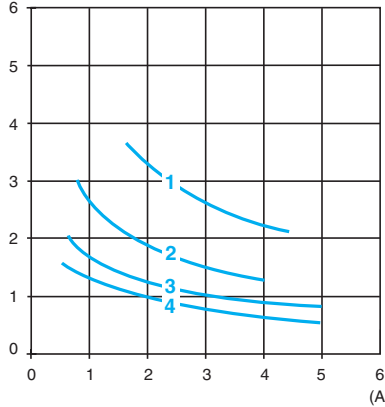

AC-13 : control of isolated solid state loads via transformer
 $\cos \varphi \geq 0.65$

Operating cycles in millions

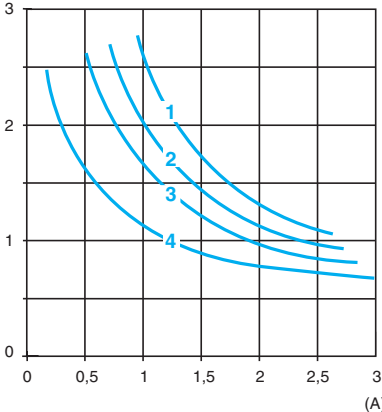

AC-14 : control of weak electromagnetic loads of electromagnets $\leq 72 \text{ VA}$
 make: $\cos \varphi = 0.3$
 break: $\cos \varphi = 0.3$
 AC-15 : control of electromagnetic loads of electromagnets $> 72 \text{ VA}$
 make: $\cos \varphi = 0.7$
 break: $\cos \varphi = 0.4$

- 1 24 V
- 2 48 V
- 3 127 V
- 4 230 V

d.c. loads

Operating cycles in millions

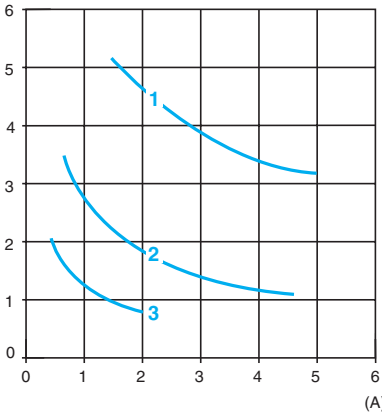

DC-12 : control of resistive loads and isolated solid state loads via optocoupler
 $L/R \leq 1 \text{ ms}$

Operating cycles in millions

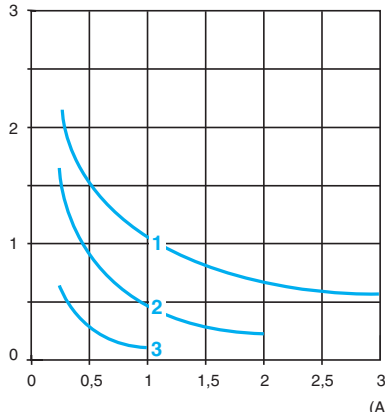

DC-13 : control of electromagnets
 $L/R \leq 2 \times (U_e \times I_e) \text{ in ms.}$
 U_e : rated operating voltage
 I_e : rated operating current

- 1 24 V
- 2 48 V
- 3 127 V

Interfaces

For discrete signals
Electromechanical interface modules
Control circuit: a.c. or d.c.



ABR1E101M



ABR1E318B



ABR1S102B



ABFC08R●●●

Input interface modules (1) (17.5 mm pitch)				
Display	Contact Configuration	Control circuit	Catalog number	Weight
				kg
Mechanical (2)	1 N/O	~ 230/240	ABR1E101M	0.090
	1 C/O	~ 230/240	ABR1E301M	0.090
Mechanical (2) + LED (3)	1 N/O	~ 24	ABR1E118B	0.095
		~ 48	ABR1E118E	0.095
		~ 110...127 (4)	ABR1E112F	0.095
		~ 115...127	ABR1E111F	0.095
		~ 230/240	ABR1E111M	0.095
	2 N/O	~ 24	ABR1E418B	0.095
		~ 48	ABR1E418E	0.095
		~ 110...127(4)	ABR1E412F	0.095
		~ 115...127	ABR1E411F	0.095
		~ 230/240	ABR1E411M	0.095
1 C/O	~ 24	ABR1E318B	0.095	
	~ 48	ABR1E318E	0.095	
	~ 110...127(4)	ABR1E312F	0.095	
	~ 115...127	ABR1E311F	0.095	
	~ 230/240	ABR1E311M	0.095	

Output terminals-relays (1) (17.5 mm pitch)				
Display	Contact Configuration	Control circuit	Catalog number	Weight
				kg
Mechanical (2)	1 N/O	~ 24	ABR1S102B	0.090
	2 N/O	~ 24	ABR1S402B	0.090
	1 C/O	~ 24	ABR1S302B	0.090
	1 N/C + 1 N/O	~ 24	ABR1S602B	0.090
Mechanical (2) + LED (3)	1 N/O	~ 24	ABR1S118B	0.095
		~ 48	ABR1S118E	0.095
		~ 115...127	ABR1S111F	0.095
	2 N/O	~ 24	ABR1S418B	0.095
		~ 48	ABR1S418E	0.095
		~ 110	ABR1S411F	0.095
	1 C/O	~ 24	ABR1S318B	0.095
		~ 48	ABR1S318E	0.095
		~ 110	ABR1S311F	0.095
		1 N/C + 1 N/O	~ 24	ABR1S618B
~ 48	ABR1S618E		0.095	
~ 110	ABR1S611F		0.095	

Commoning links					
Description	For common	Color	Distance between wire ends	Catalog number	Weight
					kg
Commoning links in modules 8 x 1 mm ²	Coil	White	12	ABFC08R12W	0.020
			2	ABFC08R02W	0.010
	~	Red	12	ABFC08R12R	0.020
			2	ABFC08R02R	0.010
	---	Blue	12	ABFC08R12B	0.020
			2	ABFC08R02B	0.010

- (1) Connection by screw-clamp.
- (2) By green mechanical indicator light for contact(s) activated electrically or mechanically by pressing the test button.
- (3) By green LED illuminated when control signal is present.
- (4) With polarization (+ on A1, - on A2).

Dimensions (mm):

ABR 1E

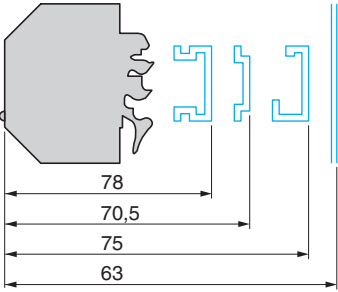

ABR 1S

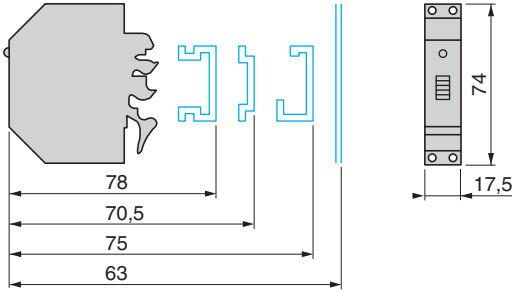

Wiring diagrams

≡ 24 V or ~ 230 V interfaces with mechanical indication

1 N/O

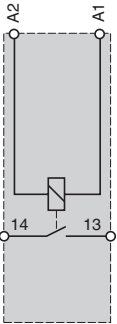

1 C/O

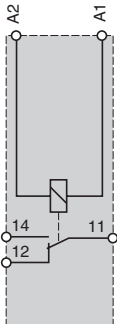

2 N/O

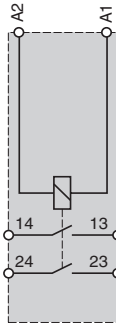

1 N/C + 1 N/O

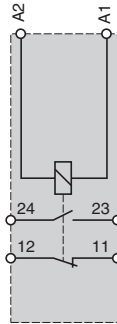

≈ 24 V or ≈ 48 V interfaces with mechanical indication + LED

1 N/O

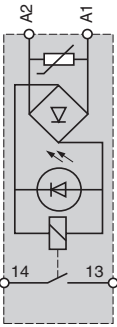

1 C/O

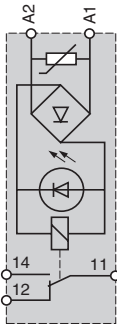

2 N/O

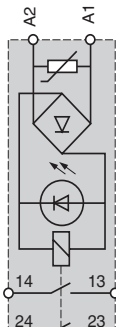

1 N/C + 1 N/O

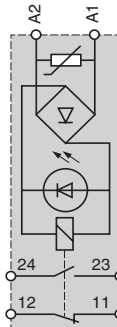

≡ / ~ 110 V or ~ 230 V interfaces with mechanical indication + LED

1 N/O

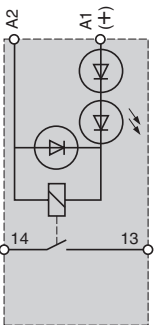

1 C/O

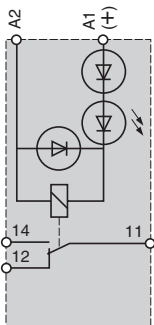

2 N/O

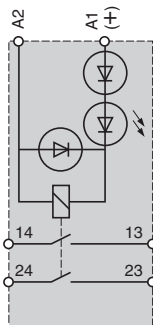

1 N/C + 1 N/O

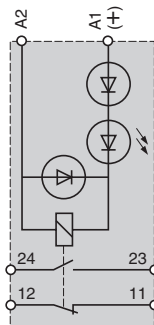

Interfaces

For discrete signals

Slim electromechanical interface modules

ABR-2 electromechanical interface modules complement the ABR-1 range. They are characterized by micro relay technology which allows reduced dimensions and very low switching levels (TTL, HCMOS, analog signals). The ABR-2 family is in the form of slim compact modules, 9.5 mm wide for input interface modules, 12 mm wide for output interface modules and 17.5 mm wide for very low level switching products.

Description

The ABR-2 includes 3 families:

Input interfaces (9.5 mm pitch)

Input interfaces are designed for switching input signals to a processor and are characterized by their advanced contact reliability: less than 1 interruption per 100 million operating cycles at ± 17 V, 5 mA.

They have increased immunity to current leakages ≤ 2 mA, and a wide coil voltage range (0.7 to 1.25 Un).

Output interfaces (12 mm pitch)

Output interfaces are designed for the control of preactuators (contactors, solenoid valves, etc) for signalling devices (indicators lamps, audible warnings etc). They are characterized by a high switching capacity and an advanced immunity to current leakages ≤ 2 mA. A lower cost version without LED signalling is available.

Low level switching input and output interfaces (17.5 mm pitch) with 1 C/O contact.

These interfaces are designed for switching logic (TTL or HCMOS) and analog signals.

Warning: never switch inductive loads with this type of interface.

The front panel of the ABR-2 electromechanical interface module includes:

- 1 LED indicating the control signal state
- 2 Channel identification : 5 individual characters for AB1-R/G or 1 AB1-SA2 marker tag
- 3 Connection by screw clamp terminal enabling easy attachment of 2 wires per terminal. The layout of the connection terminals for both families (input and output) is designed for rational wiring and a clear separation between the incoming (processing) and outgoing (power and process control) circuits.

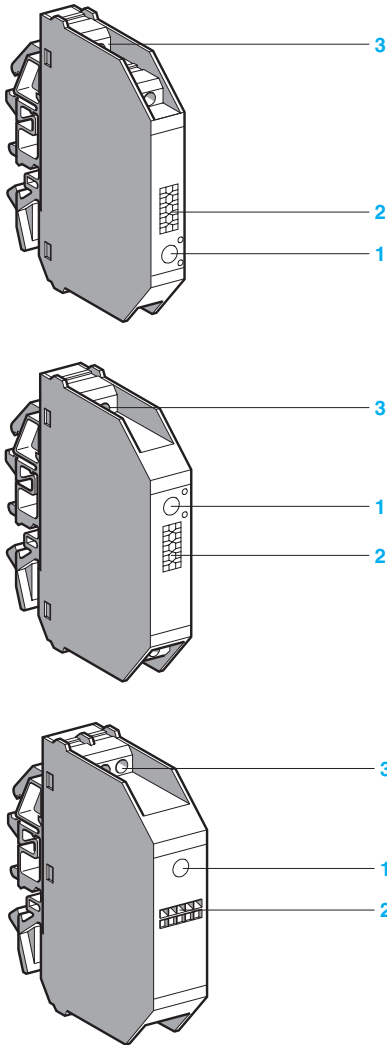

Examples of applications with PLCs

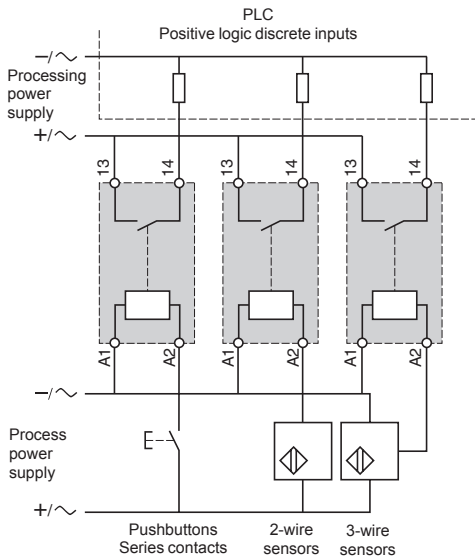

ABR2E●●●●

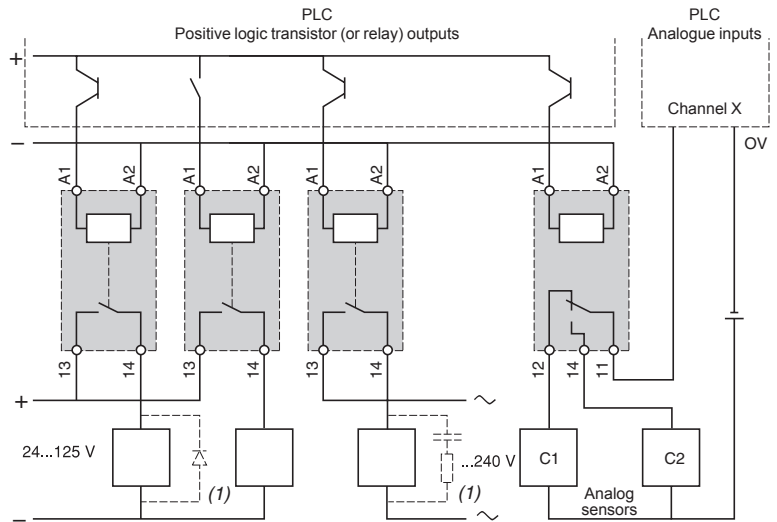

ABR2S●●●●

ABR2SB12B

(1) Essential on inductive loads (can be replaced with peak limiter).

Environment

Conforming to standards		IEC 60947-1, UL 508, CSA C22.2 No. 14	
Product certifications		UL, CSA, BV, LROS, DNV	
Degree of protection	Conforming to IEC 529 (protection against direct contact)	IP 20	
Protective treatment		"TC"	
Flame resistance	Conforming to IEC 695-2-1	Incandescent wire	°C 960
		Conforming to UL 94	V0
Shock resistance	Conforming to IEC 68-2-27	Semi-sinusoidal waves 11 ms	30 gn
Vibration resistance	Conforming to IEC 68-2-6	10...150 Hz	3 gn
Resistance to electrostatic discharges	Conforming to IEC 801-2	Level 3	kV 8
Resistance to electromagnetic fields	Conforming to IEC 801-3	Level 3 ; 27...1000 MHz	V/m 10
Resistance to rapid transients	Conforming to IEC 801-4 Level 3	On power supply	kV 2
		On I/O	kV 1
Resistance to shock waves	Conforming to IEC 947-1	Waveform	
		1.2/50 μs ; 0.5 J	U < 50 V kV 0.5
			U < 150 V kV 1.5
			U < 300 V kV 2.5
Cross-sections which may be connected	Flexible wire with no cable end	1 or 2-wire	mm ² 0.6...2.5
	Flexible wire with cable end	1 or 2-wire	mm ² 0.34...2.5
	Rigid cable	1-wire	mm ² 0.27...4
Operating position		Any	
Ambient air temperature	Unrestricted operation	°C	- 5...+ 40
	Operation from 0.85...1.1 Us (assigned voltage)	°C	- 5...+ 55
	Operation restricted to Us (assigned voltage)	°C	- 25...+ 70 (2)
	Storage	°C	- 40...+ 80
Operating altitude		m	≤ 3000
Installation category	Conforming to IEC 947-1		II
Degree of pollution	Conforming to IEC 947-1		2
Mounting			Standard DIN rails

(2) Leave space of 8 mm between ABR-2S1●●● for an ambient temperature ≥ 55 °C

Control circuit characteristics (40°C ambient temperature)									
Type of interface		ABR 2E112B	ABR 2E112E	ABR 2E115F	ABR 2E116F	ABR 2E111M	ABR 2S112B	ABR 2S102B	ABR 2●B312B (1)
Rated voltage (Us)	V	--- 24	--- 48	~ 115...127	~ 120...127	~ 230...240	--- 24	--- 24	--- 24
Current frequency	Hz	–	–	50	60	50/60	–	–	–
Energization threshold	V	16.9	37.3	93	97	186	16.9	14.5	16.9
Maximum operating voltage	V	28.8	57.6	140	140	264	28.8	28.8	28.8
Maximum drop-out voltage (Uo)	V	3.8	8.5	25.4	25.4	48	3.8	2	3.8
Maximum current (at Us)	mA	19.5	11	14	16	15	28	18	23
Minimum holding current	mA	2	2	2.5	2.5	2.5	2	1.3	2
Maximum dissipated power (at Us)	50 Hz	W	–	0.66	–	0.54	–	–	–
	60 Hz	W	0.45	0.52	–	0.73	0.77	0.64	0.43
Disappearance of voltage maximum time up to which contact is maintained	ms	1	1	10	10	10	1	5	1
Display of control circuit by LED		Yes	Yes	Yes	Yes	Yes	Yes	No	Yes
Built-in protection reversed polarity		Yes	Yes	–	–	–	Yes	Yes	Yes

Contact characteristics (40°C ambient temperature)									
Type of interface		ABR2E●●●●	ABR2S112B	ABR2S102B	ABR2●B312B (1)				
Contact configuration		1 N/O	1 N/O	1 N/O	1 C/O				
Maximum rated operating voltage (Ue max)	~ V	127	230	230	48				
	--- V	100	120	120	48				
Maximum switching voltage	~ V	140	250	250	60				
	--- V	125	150	150	60				
Operating current frequency	Hz	50/60	50/60	50/60	50/60				
Thermal current Ith	A	1	5	5	0.05				
Rated operating current (Ie) for 1 million operating cycles	Conforming to IEC 947-5-1	AC12	A	1	3	3	–		
		AC14	A	0.5	1	1	–		
	AC15	A	0.5	1	1	–			
	Conforming to IEC 947-5-1 Ue : --- 24 V	DC12	A	1	1.7	1.7	–		
		DC13	A	1	1.5	1.5	–		
Minimum switching current	mA	1	5	5	0.01				
Minimum switching voltage	V	5	5	5	0.01				
Protection against short-circuits	For I _k ≤ 1 kA (~) and ≤ 100 A (---) Type and value of recommended fuse	Type : quick-blow fuse with high breaking capacity							
		A	2	6.3	6.3	0.4			
Low level contact performance (17 V, 5 mA) ABR-2●B (30 mV, 10 μA)	Number of interruptions per "n" million operating cycles	1 per 100 million							

Other characteristics									
Maximum operating time at Us (bounce included)	Between energization of coil and closing of N/O contact	---	ms	10	10	10	6		
		~	ms	30	–	–	–		
	Between energization of coil and opening of N/C contact		ms	–	–	–	6		
	Between de-energization of coil and opening of N/O contact	---	ms	6	12	5	6		
		~	ms	30	–	–	–		
	Between de-energization of coil and closing of N/C contact		ms	–	–	–	6		
Maximum duration of bounce		ms	5	5	5	2			
No make before break guaranteed between "N/C" and "N/O" contacts	Maximum make before break	On energization	ms	–	–	–	5		
	before break or break	On de-energization	ms	–	–	–	2		
Maximum operating rate	At no-load	Hz	10	10	10	10			
	At Ie	Hz	0.5	0.5	0.5	–			
Mechanical durability in millions of operating cycles			20	10	10	20			
Rated insulation voltage	Conforming to IEC 947-1	V	300	300	300	300			
	Conforming to VDE 0110 group C	V	250	250	250	250			
Insulation test voltage for 1 min	Coil circuit/contact circuits	kV rms	2	4	4	1.5			
	Wired interface/ground	kV rms	2.5	2.5	2.5	2.5			
	Between open contacts	kV rms	0.75	1	1	1			

(1) Do not switch inductive loads.

Electrical durability of contacts (ABR 2S)

Test conditions : in accordance with standard IEC 947-5-1 set up for rated control voltage.

a.c. loads

Operating cycles in millions

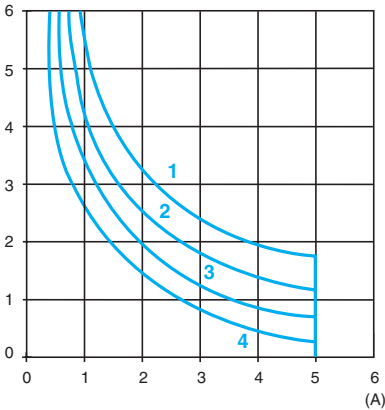

AC12 : control of resistive loads and isolated solid state loads via optocoupler
 $\cos \varphi \geq 0.9$

Operating cycles in millions

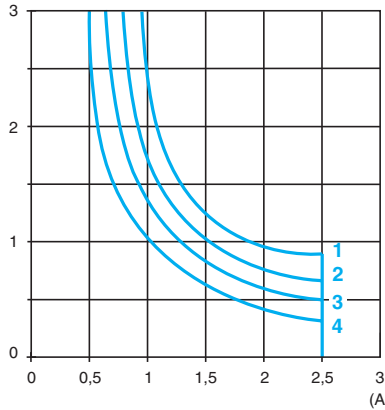

- 1 24 V
- 2 48 V
- 3 115 V
- 4 230 V

AC14 : control of weak electro-magnetic loads of electro-magnets $\leq 72 \text{ VA}$
 make : $\cos \varphi = 0.3$
 break : $\cos \varphi = 0.3$
 AC15 : control of electro-magnetic loads of electro-magnets $> 72 \text{ VA}$
 make : $\cos \varphi = 0.7$
 break : $\cos \varphi = 0.4$

d.c. loads

Operating cycles in millions

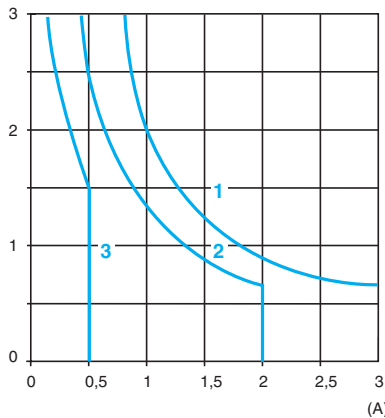

DC12 : control of resistive loads and isolated solid state loads via optocoupler
 $L/R \leq 1 \text{ ms}$

Operating cycles in millions

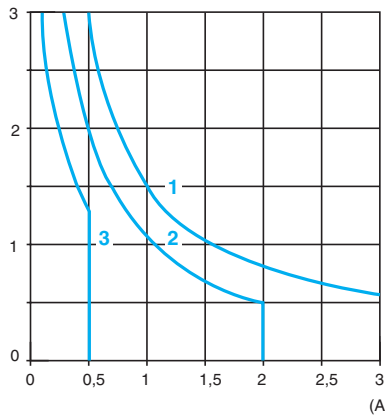

- 1 24 V
- 2 48 V
- 3 115 V

DC13 : control of electro-magnets
 $L/R \leq 2 \times (U_e \times I_e)$ in ms.
 U_e : rated operating voltage
 I_e : rated operating current
 (with a load protection diode)

Interfaces

For discrete signals
Slim electromechanical interface modules
Control circuit: a.c. or d.c.

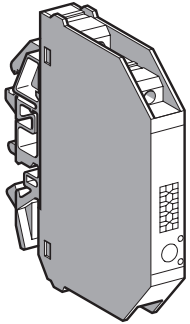

ABR2E112B

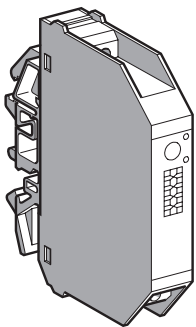

ABR2S112B

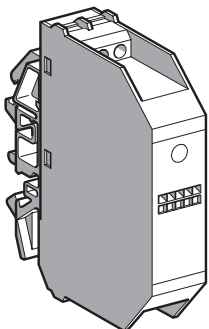

ABR2EB112B



ABFC08R●●●

Input modules (9.5 mm pitch)

Indication	Contact Configuration	Control circuit	Sold in lots of	Catalog number	Weight
V					
With LED	1 N/O	⎓ 24	5	ABR2E112B	0.032
		⎓ 48	5	ABR2E112E	0.032
		~ 115...127 (50 Hz)	5	ABR2E115F	0.035
		~ 120...127 (60 Hz)	5	ABR2E116F	0.035
		~ 230...240 (50/60 Hz)	5	ABR2E111M	0.036

Output modules (12 mm pitch)

Indication	Contact Configuration	Control circuit	Sold in lots of	Catalog number	Weight
V					
Without	1 N/O	⎓ 24	5	ABR2S102B	0.040
With LED	1 N/O	⎓ 24	5	ABR2S112B	0.041

Modules for very low level switching (17.5 mm pitch)

Indication	Contact Configuration	Control circuit	Catalog number	Weight
V				
Input				
With LED	1 C/O (1)	⎓ 24	ABR2EB312B	0.048
Output				
With LED	1 C/O (1)	⎓ 24	ABR2SB312B	0.048

Flexible comb accessories

Description	For common	Color	Distance between wire ends	Catalog number	Weight
cm					
Flexible comb modularity 8 x 1 mm ²	Coil	White	12	ABFC08R12W	0.020
			2	ABFC08R02W	0.010
	~	Red	12	ABFC08R12R	0.020
			2	ABFC08R02R	0.010
	⎓	Blue	12	ABFC08R12B	0.020
			2	ABFC08R02B	0.010

(1) Not for use with inductive loads.

Dimensions (mm):

ABR2E11●●

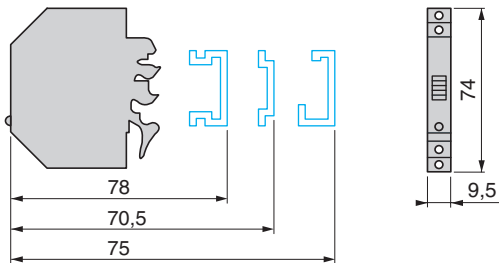

ABR2S1●2B

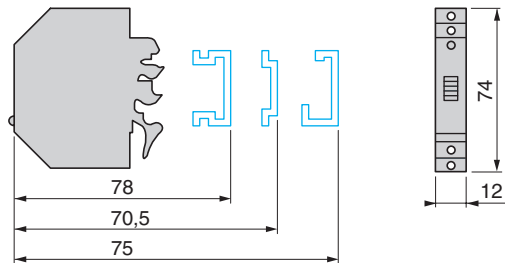

ABR2EB312B

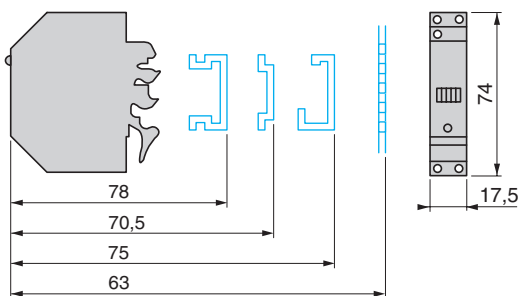

ABR2SB312B

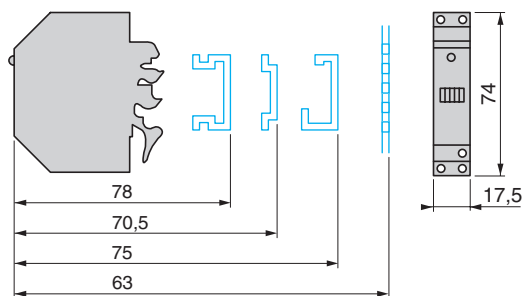

Circuit diagrams

ABR2E112B ($\overline{\text{DC}}$ 24 V)

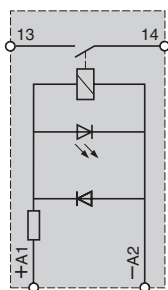

ABR2E112E ($\overline{\text{DC}}$ 48 V)

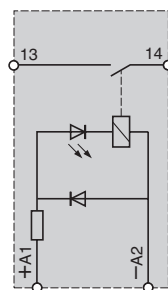

ABR2E11●F/M (\sim 115...240 V)

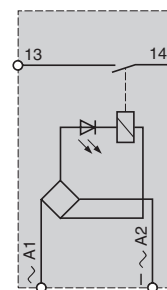

ABR2S102B ($\overline{\text{DC}}$ 24 V)

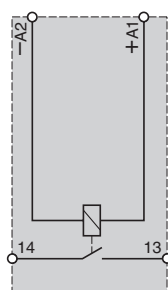

ABR2S112B ($\overline{\text{DC}}$ 24 V)

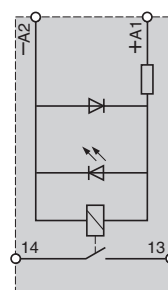

ABR2●B312B ($\overline{\text{DC}}$ 24 V)

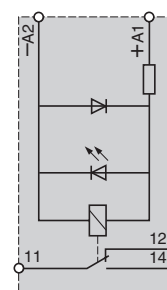

Interfaces

For discrete signals
Slim solid-state interface modules

The ABS-2 solid-state interface relays are supplied in the form of compact modules which appear identical to the ABR-2 electromechanical family. They are designed for interfacing discrete digital control signals exchanged within an automated system between the processor (PLC, numerical controller, etc) and the other components (contactors, solenoid valves, indicator lamps, proximity sensors). They are suitable for use in equipment which requires the benefits of electronic technology: a high operating rate, enhanced durability, silent operation. These products are notable for their high performance and excellent adaptation to industrial environments. They also conform to the most recent IEC standards.

Composition

The ABS-2 range includes 2 families:

Input interfaces

The 9.5 mm wide input interfaces are designed for switching input signals to processors. They offer a wide choice of electrical isolation between signals due to the wide range of input voltages from \sim 5 V to \sim 230 V.

Output interfaces

Output interfaces are designed for the control of preactuators (contactors, solenoid valves, etc) for the signalling devices (indicator lamps, audible warnings, etc). Two widths are available, 9.5 and 17.5 mm, depending on the switched current.

The 17.5 mm version includes a 9.5 mm interface and an integrated 8 mm spacer. This device can, with its increased ventilation, switch high levels of currents.

The front panel of the ABS-2 slim solid-state interface modules includes:

- 1 LED indicating the state of the control signal.
 - 2 Channel identification : 5 individual characters for AB1-/G or one AB1-SA2 marker tag.
 - 3 Connection by screw clamp terminal enabling easy attachment of 2 wires per terminal.
 - 4 Integrated spacer.
- The layout of the connection terminals for both families (input and output) is designed for rational wiring and a clear separation between the incoming (processing) and outgoing (power and process control) circuits.

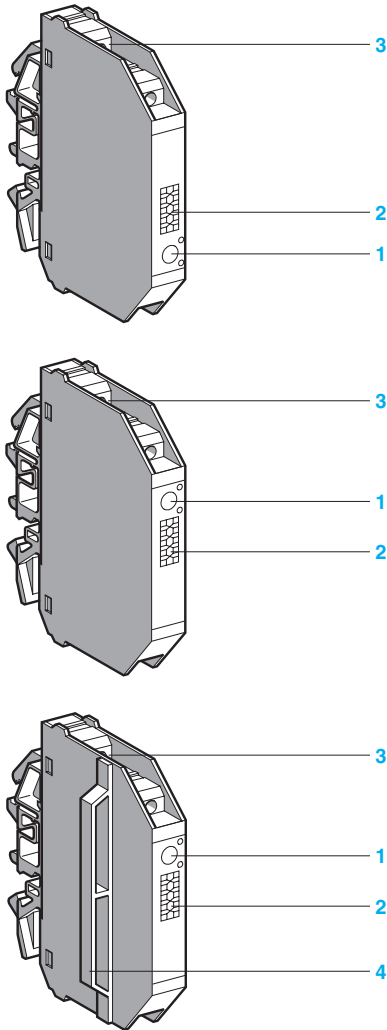

Examples of applications with PLCs

Interfacing PLC discrete inputs

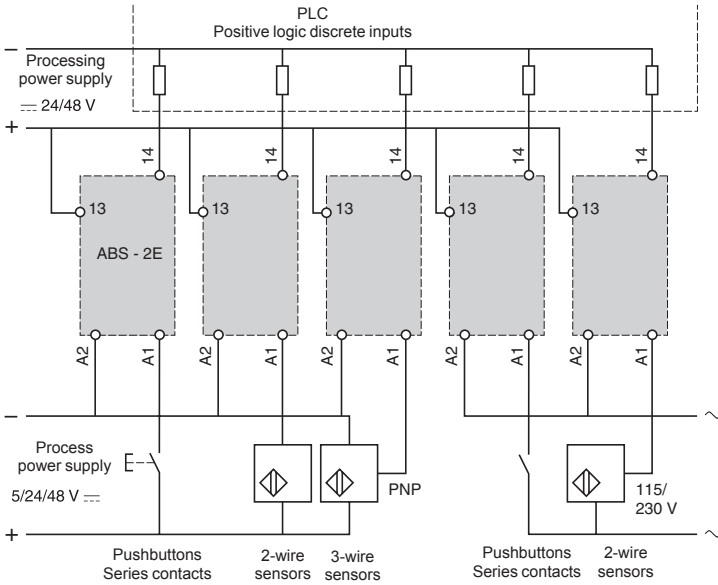

Interfacing PLC discrete outputs

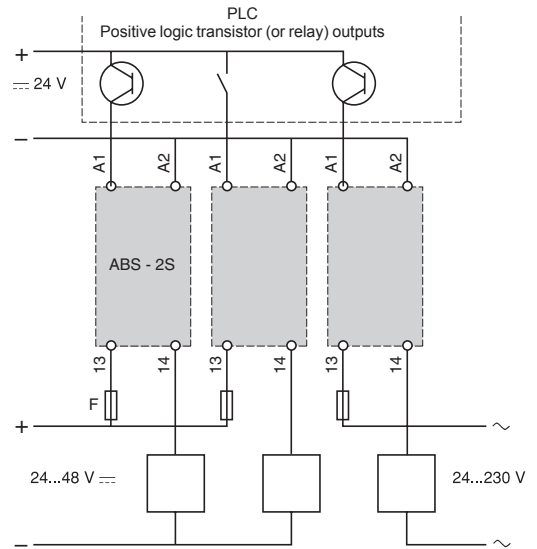

Environment

Conforming to standards		IEC 60947-1, UL 508, CSA C22.2 No. 14	
Product certifications		UL, CSA, BV, LROS, DNV	
Degree of protection	Conforming to IEC 529 (protection against direct contact)	IP 20	
Protective treatment		"TC"	
Flame resistance	Conforming to IEC 695-2-1	Incandescent wire	°C 960
		Conforming to UL 94	V0
Shock resistance	Conforming to IEC 68-2-27	Semi-sinusoidal waves 11 ms	30 gn
Vibration resistance	Conforming to IEC 68-2-6	10...150 Hz	5 gn
Resistance to electrostatic discharges	Conforming to IEC 801-2	Level 3	kV 8
Resistance to electromagnetic fields	Conforming to IEC 801-3	Level 3 ; 27...1000 MHz	V/m 10
Resistance to rapid transients	Conforming to IEC 801-4 Level 3	On power supply	kV 2
		On I/O	kV 1
Resistance to shock waves	Conforming to IEC 947-1	Waveform	kV 0.5
		1.2/50 ms ; 0.5 J	U < 50 V kV 1.5
			U < 150 V kV 2.5
			U < 300 V kV 2.5
Cross-sections which may be connected	Flexible wire with no cable end	1 or 2-wire	mm ² 0.6...2.5
	Flexible wire with cable end	1 or 2-wire	mm ² 0.34...2.5
	Rigid cable	1-wire	mm ² 0.27...4
Operating position		Any	
Ambient air temperature around the device	Unrestricted operation	°C	- 5...+ 55
	Operation at Us	°C	- 25...+ 70
	Storage	°C	- 40...+ 80
Operating altitude		m	≤ 300
Installation category	Conforming to IEC 947-1	II	
Degree of pollution	Conforming to IEC 947-1	2	
Mounting		Standard DIN rails	

Control circuit characteristics (55°C ambient temperature)									
Type of interface			ABS 2EC01EA	ABS 2EC01EB	ABS 2EC01EE	ABS 2EA01EF	ABS 2EA02EF	ABS 2EA01EM	ABS 2EA02EM
Rated voltage U_s	≡	V	5	24	48	–	–	–	–
	~	V	–	–	–	115/127 50 Hz	120/127 60 Hz	230/240 50 Hz	230/240 60 Hz
Maximum voltage	≡	V	Negative logic 6 (TTL)	28.8	57.6	–	–	–	–
	~	V	–	–	–	140	140	264	264
Maximum current at U_s	≡	mA	13.6	12	10.5	–	–	–	–
	~	mA	–	–	–	14	17	12.5	15
State 1	≡	V	3.75	16.9	36	–	–	–	–
		mA	4.5	7.7	7.5	–	–	–	–
	~	V	–	–	–	86.3	90	173	173
		mA	–	–	–	8.4	9.7	7.9	9.3
State 0	≡	V	2	5.6	10.8	–	–	–	–
		mA	0.09	2	2	–	–	–	–
	~	V	–	–	–	25.4	25.4	48	48
		mA	–	–	–	2.5	2.5	2.5	2.5
State 1 display			Yes	Yes	Yes	Yes	Yes	Yes	
Internal protection reversed polarity			Yes	Yes	Yes	–	–	–	–
Output circuit characteristics									
Rated operating voltage U_e	≡	V	5...48						
Min/max voltage	≡	V	2/60						
Min/max current switched		mA	1/50						
Maximum residual current at state 0		mA	0.1						
Maximum volt drop at state 1		V	1						
Internal protection			Reversed polarity						
External protection			Against short-circuits for $I_k \leq 100$ A (≡) Quick-blow fuse, ref. : HA21 0.25 A or equivalent						
Other characteristics									
Type of interface			ABS 2EC01EA	ABS 2EC01EB	ABS 2EC01EE	ABS 2EA01EF	ABS 2EA02EF	ABS 2EA01EM	ABS 2EA02EM
Time delay characteristics	0 → 1	ms	0.05	0.05	0.05	10	10	10	10
	1 → 0	ms	0.4	0.4	0.4	20	20	20	20
Maximum switching rate		Hz	1000	1000	1000	25	25	25	25
Duty cycle 50 % $U_e \leq 30$ V $I_e \geq 5$ mA									
Rated insulation voltage			Conforming to IEC 947-1 : 300 V Conforming to VDE 0110 : 250 V group C						
Insulation test voltage for 1 minute	I/O	kVrms	4						
	Wired interface/ground	kVrms	2.5						

Control circuit characteristics (55°C ambient temperature)						
Type of interface		ABS2SC01EB	ABS2SC02EB	ABS2SA01MB	ABS2SA02MB	
Rated voltage Us	---	V	24	24	24	
Maximum voltage		V	28.8	28.8	28.8	
Maximum current at Us		mA	12	13.6	13.6	
State 1		V	16.9	16.9	16.9	
		mA	7.7	8.3	8.3	
State 0		V	5.6	5.3	5.3	
		mA	2	2	2	
State 1 display			Yes	Yes	Yes	
Internal protection reversed polarity			Yes	Yes	Yes	
Output circuit characteristics						
Rated operating voltage Ue		V	--- 5...48	--- 5...48	~ 24...240	~ 24...240
Maximum voltage		V	--- 57.6	--- 57.6	~ 264	~ 264
Maximum continuous current (Ith) (1) at 40 °C		A	2	3	2.3	3
Rated operating voltage (Ie) Conforming to IEC 947-5-1 Single/touching product at 55 °C vertical position		A	DC12 1.5/0.9	2.5/2.2	AC12 1.9/0.5	2.1/1.5
		A	DC13 1.5/0.9	2.5/2.2	AC13 1.6/0.5	1.6/1.5
		A	DC14 0.6/0.6	0.6/0.6	AC14 1.6/0.5	1.6/1.5
		A	– –	–	AC15 1/0.5	1/1
Minimum current	---/~	mA	1	1	10	10
Maximum residual current	---/~	mA	1	1	2.5	2.5
Maximum volt drop		V	1.5	1.5	3 (Ie ≥ 10 mA) 1.5 (Ie ≥ 100 mA)	3 (Ie ≥ 10 mA) 1.5 (Ie ≥ 100 mA)
"0 crossing" voltage		V	–	–	50 peak	50 peak
Solid-state dV/dt		V/μs	–	–	500	500
Internal protection			Reversed polarity			
External protection			Against short-circuits for Ik ≤ 1 kA (~) and ≤ 100 A (---) Quick-blow fuse with high breaking capacity: 3.15 A			
Other characteristics						
Maximum response time at Ie □ 10 mA	0 → 1	ms	0.05		10 (50 Hz) ; 8 (60Hz)	
	1 → 0	ms	0.6		10 (50 Hz) ; 8 (60Hz)	
Maximum switching rate	At 55 °C ; at Ie: module alone duty cycle 40 %	Hz	DC13 6	6	AC13 0.6	0.7
		Hz	DC14 1	3	AC14 0.6	0.7
		Hz	– –	–	AC15 0.6	0.7
	On resistive load duty cycle 50 %	Hz	700		50	
Rated operating voltage			Conforming to IEC 947-1 : ~ 300 V			
			Conforming to VDE 0110 : 250 V group C			
Rated Insulation voltage for 1 minute	I/O	kVrms	4			
	Wired interface/ground	kVrms	2.5			

(1) See temperature derating curves.

Solid-state input modules

Width mm	Input circuit		Output circuit		Sold in lots of	Catalog number	Weight kg
	Current	Nominal voltage V	Current	Nominal voltage V			
9.5	—	5	—	5...48	5	ABS2EC01EA	0.029
		24	—	5...48	5	ABS2EC01EB	0.029
		48	—	5...48	5	ABS2EC01EE	0.029
	~	115...127 (50 Hz)	—	5...48	5	ABS2EA01EF	0.032
		120...127 (60 Hz)	—	5...48	5	ABS2EA02EF	0.032
		230...240 (50 Hz)	—	5...48	5	ABS2EA01EM	0.033
		230...240 (60 Hz)	—	5...48	5	ABS2EA02EM	0.033

Solid-state output modules

Width mm	Input circuit		Output circuit		Sold in lots of	Catalog number	Weight kg
	Current	Nominal voltage V	Current A	Nominal voltage V			
9.5	—	24	— 2	24...48	5	ABS2SC01EB	0.034
			~ 2.3	24...230	5	ABS2SA01MB	0.034
17.5	—	24	— 3	24...48	1	ABS2SC02EB	0.043
			~ 3	24...230	1	ABS2SA02MB	0.044

Accessories

For connecting commons, use **ABFC08●●●** flexible combs (Please consult your Regional Sales Offices).

Temperature derating curve for solid-state output modules $U_c = U_s = \text{—} 24 \text{ V}$

ABS2SC01EB d.c.

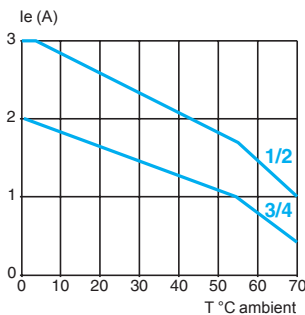

ABS2SC02EB d.c.

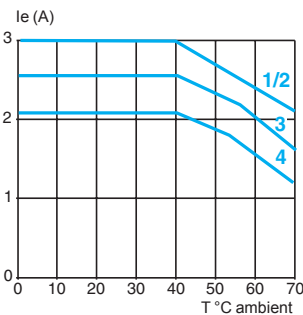

ABS2SA01MB a.c.

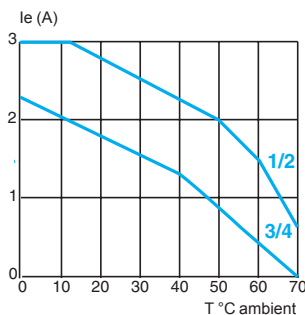

ABS2SA02MB a.c.

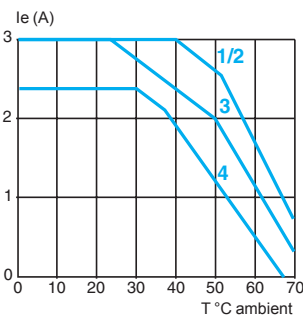

1 Vertical module alone or adjacent to modules with low heat dissipation.

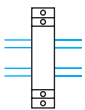

2 Horizontal module alone or adjacent to modules with low heat dissipation.

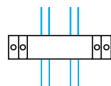

3 Vertical module mounted with 2 modules with identical heat dissipation on both sides.

4 Horizontal module mounted with 2 modules with identical heat dissipation on both sides.

Dimensions (mm):

ABS2E/ABS 2S●01●●

ABS2S●02●●

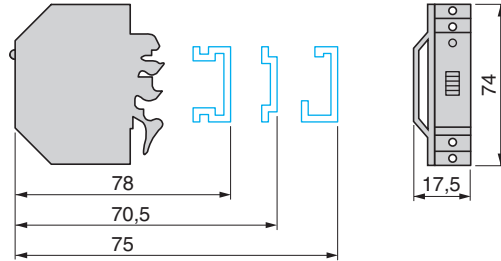
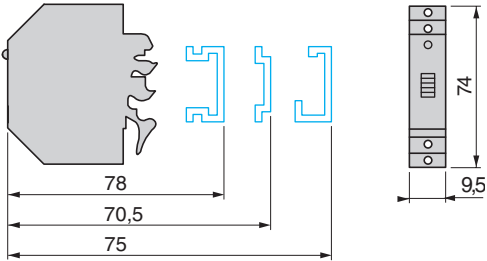

Circuit diagrams

Solid-state input modules

ABS2EC●●●●

ABS2EA●●●●

ABS2E●●●●

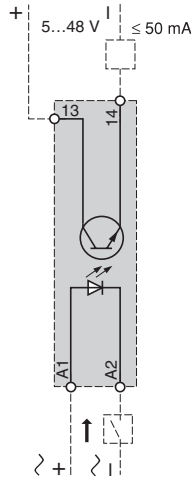
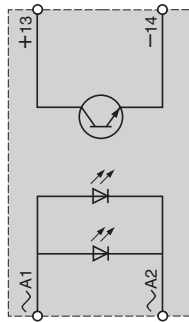
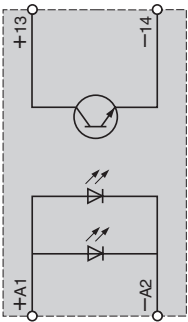

Solid-state output modules

ABS2SC0●EB

ABS2SA0●MB

ABS2SC0●EB

ABS2SA0●MB

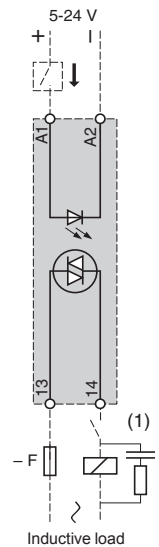
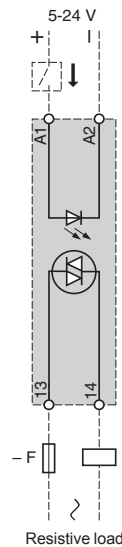
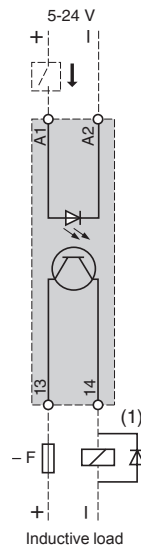
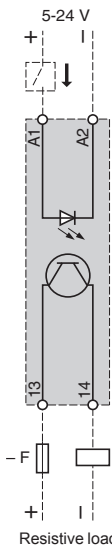
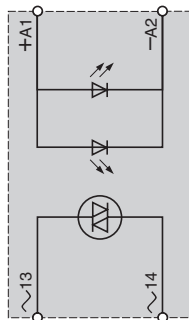
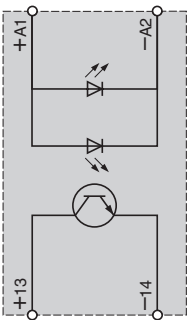

F: fuse DF1 SS133.2
(1) or peak limiter (2)

Applications

Panel mounted



Contact type

1 N/O SPST contact

Control voltage ranges



90...280 V
3...32 V, 3.5...32 V

Operating voltages



24...280 V, 48...530 V, 48...660 V
0...100 V

Type of switching



Zero voltage switching
DC switching

Current



10, 25, 50, 75, 90, 125 A
12, 25, 40

Degree of protection

IP20

LED indication

Yes

Cooling

Thermal protection or with heat sink accessory

Solid state relay type

SSRP

Page

76

DIN rail mounted



1 N/O SPST contact

90...280 V

90...140 V

4...32 V

3...32 V

24...280 V

Zero voltage switching

10, 20, 30 A

45 A

IP20

Yes

Built-in heat sink

SSRD

76

Introduction

The **SSR** solid state relay range includes:

- relays for panel mounting: **SSRP**.
- relays for DIN rail mounting: **SSRD**.

Description

SSRP relays for panel mounting

- 1 2 x Ø 4.9 holes for mounting.
- 2 Connection terminals.
- 3 Connection terminal screws.
- 4 Input voltage indicator LED, green.
- 5 Thermal interface which must be via the back of the product.



SSRD relays for DIN rail mounting

- 1 Lugs for plate mounting.
- 2 Built-in heat sink.
- 3 Connection terminals.
- 4 Connection terminal screws.
- 5 Input voltage indicator LED, green.
- 6 Bracket for mounting on 35 mm DIN rail.



General characteristics

SSRP solid state relays, panel mounting

Product certifications			UR E258297, CSA LR 40787, IEC 60950-1, IEC 62314
Product marking			CE
Ambient air temperature around the device	Storage	°C	- 40...+ 80
	Operation	°C	- 40...+ 125
Encapsulation			Thermally conductive epoxy
Degree of protection			IP20 (with cover), IP00 (without cover)
Terminal screw torque		Nm	Inputs: 1.1 (screw: Ø 3.5 / length 6 mm) Outputs: 2.2 (screw: Ø 4 / length 7.4 mm)

SSRD solid state relay, DIN rail mounting

Product certifications			UR E258297, CSA LR 40787, IEC 60950-1, IEC 62314
Product marking			CE
Ambient air temperature around the device	Storage	°C	- 40...+ 80
	Operation	°C	- 40...+ 125
Encapsulation			Thermally conductive epoxy
Degree of protection			IP20
Terminal screw torque	10...30 A relays	Nm	Inputs: 0.6...0.7 / Outputs: 0.6...0.7
	45 A relays	Nm	Inputs: 0.6...0.7 / Outputs: 1.1...1.7
Max. wire size	10...30 A relays		Inputs: 5.3 mm ² - AWG 10 / Outputs: 5.3 mm ² - AWG 10
	45 A relays		Inputs: 3.3 mm ² - AWG 12 / Outputs: 8.4 mm ² - AWG 8

SSRP solid state relays, panel mounting				
Relay type	SCR output, Zero voltage switching	SSRPCDS10A1	SSRPCDS25A1	SSRPCDS50A1
Input specification				
Control voltage range	$\overline{\text{---}} \text{ V}$	3...32	3...32	3...32
Maximum turn-on voltage	$\overline{\text{---}} \text{ V}$	3	3	3
Maximum turn-off voltage	$\overline{\text{---}} \text{ V}$	1.0	1.0	1.0
Maximum typical input current	mA	10 at $\overline{\text{---}}$ 12 V	10 at $\overline{\text{---}}$ 12 V	10 at $\overline{\text{---}}$ 12 V
Output specification				
Operating voltage	$\sim \text{ V}$	24...280	24...280	24...280
Load current range	A	0.15...10	0.15...25	0.15...50
Transient overvoltage	Vpk	600	600	600
Maximum surge current (16.6 ms)	Apk	120	250	625
Maximum On-state voltage drop at rated current	Vrms	1.6	1.6	1.6
Thermal resistance junction to base plate	$^{\circ}\text{C/W}$	1.48	1.02	0.63
Maximum I ² t for fusing (8.3 ms)	A²sec	60	260	1620
Maximum off-state leakage current at rated voltage	mA	1.0	1.0	1.0
Minimum off-state dv/dt at maximum rated voltage	V/μsec	500	500	500
Maximum turn-on time	Cycle	1/2	1/2	1/2
Maximum turn-off time	Cycle	1/2	1/2	1/2
Relay type	SCR output, Zero voltage switching	SSRPCDS75A2	SSRPCDS90A3	SSRPCDS125A3
Input specification				
Control voltage range	$\overline{\text{---}} \text{ V}$	3...32	3...32	3...32
Maximum turn-on voltage	$\overline{\text{---}} \text{ V}$	3	3	3
Maximum turn-off voltage	$\overline{\text{---}} \text{ V}$	1.0	1.0	1.0
Typical input current	mA	10 at $\overline{\text{---}}$ 12 V	10 at $\overline{\text{---}}$ 12 V	10 at $\overline{\text{---}}$ 12 V
Output specification				
Operating voltage	$\sim \text{ V}$	48...530	48...660	48...660
Load current range	A	0.15...75	0.25...90	0.25...125
Transient overvoltage	Vpk	1200	1200	1200
Maximum surge current (16.6 ms)	Apk	1110	1350	2000
Maximum On-state voltage drop at rated current	Vrms	1.6	1.7	1.7
Thermal resistance junction to base plate	$^{\circ}\text{C/W}$	0.31	0.28	0.22
Maximum I ² t for fusing (8.3 ms)	A²sec	4150	6000	12 700
Maximum off-state leakage current at rated voltage	mA	1.0	1.0	1.0
Minimum off-state dv/dt at maximum rated voltage	V/μsec	500	500	500
Maximum turn-on time	Cycle	1/2	1/2	1/2
Maximum turn-off time	Cycle	1/2	1/2	1/2
Relay type	SCR output, Zero voltage switching	SSRPP8S10A1	SSRPP8S25A1	SSRPP8S50A1
Input specification				
Operating voltage	$\sim \text{ V}$	90...280	90...280	90...280
Maximum turn-on voltage	Vrms	90	90	90
Maximum turn-off voltage	Vrms	10	10	10
Typical input current	mA	6 at 120 Vrms	6 at 120 Vrms	6 at 120 Vrms
Output specification				
Operating voltage	$\sim \text{ V}$	24...280	24...280	24...280
Load current range	A	0.15...10	0.15...25	0.15...50
Transient overvoltage	Vpk	600	600	600
Maximum surge current (16.6 ms)	Apk	400	600	850
Maximum On-state voltage drop at rated current	Vrms	1.6	1.6	1.6
Thermal resistance junction to base plate	$^{\circ}\text{C/W}$	1.48	1.02	0.63
Maximum I ² t for fusing (8.3 ms)	A²sec	60	260	1620
Maximum off-state leakage current at rated voltage	mA	10 max.	10 max	10 max
Minimum off-state dv/dt at maximum rated voltage	V/μsec	500	500	500
Maximum turn-on time	ms	10 max.	10 max.	10 max.
Maximum turn-off time	ms	40 max.	40 max.	40 max.
Relay type	Mosfet output	SSRPCDM12D5	SSRPCDM25D5	SSRPCDM40D5
Input specification				
Control voltage range (input voltage)	$\overline{\text{---}} \text{ V}$	3.5...32	3.5...32	3.5...32
Maximum turn-on voltage	$\overline{\text{---}} \text{ V}$	3.5	3.5	3.5
Maximum turn-off voltage	$\overline{\text{---}} \text{ V}$	1.0	1.0	1.0
Typical input current	mA	1.6 ($\overline{\text{---}}$ 5 V), 28 ($\overline{\text{---}}$ 32 V)	1.6 ($\overline{\text{---}}$ 5 V), 28 ($\overline{\text{---}}$ 32 V)	1.6 ($\overline{\text{---}}$ 5 V), 28 ($\overline{\text{---}}$ 32 V)
Output specification				
Control voltage range	$\overline{\text{---}} \text{ V}$	0...100	0...100	0...100
Load current range	A	12	25	40
Minimum load current	mA	0	0	0
Maximum surge current (16.6 ms)	Apk	28	51	106
Maximum On-state voltage drop at rated current	Vpk	1.6	2.1	2.1
Thermal resistance junction to base plate	$^{\circ}\text{C/W}$	1.34	0.83	0.83
Maximum off-state leakage current at rated voltage	mA	0.2	0.3	0.3
On-state resistance	Ω	0.13	0.05	0.05
Maximum turn-on time	μsec	100	100	100
Maximum turn-off time	msec	1.0	1.0	1.0

SSRP solid state relays, panel mounting (continued)					
Relay type	SCR output, Zero voltage switching	SSRPP8S75A2	SSRPP8S90A3	SSRPP8S125A3	
Input specification					
Operating voltage	~ V	90...280	90...280	90...280	
Maximum turn-on voltage	Vrms	90	90	90	
Maximum turn-off voltage	Vrms	10	10	10	
Typical input current	mA	6 at 120 Vrms	6 at 120 Vrms	6 at 120 Vrms	
Output specification					
Operating voltage	~ V	48...530	48...660	48...660	
Load current range	A	0.15...75	0.25...90	0.25...125	
Transient overvoltage	Vpk	1200	1200	1200	
Maximum surge current (16.6 ms)	Apk	1110	1350	2000	
Maximum On-state voltage drop at rated current	Vrms	1.6	1.7	1.7	
Thermal resistance junction to base plate	°C/W	0.31	0.28	0.22	
Maximum I²t for fusing (8.3 ms)	A²sec	4150	6000	12 700	
Maximum off-state leakage current at rated voltage	mA	10 max.	5 max.	5 max.	
Minimum off-state dv/dt at maximum rated voltage	V/µsec	500	500	500	
Maximum turn-on time	ms	10 max.	10 max.	10 max.	
Maximum turn-off time	ms	40 max.	40 max.	40 max.	
SSRD solid state relay, DIN rail mounting					
Relay type	SCR output, Zero voltage switching	SSRDP8S10A1	SSRDP8S20A1	SSRDP8S30A1	SSRDF8S45A1
Input specification					
Operating voltage	~ V	90...280	90...280	90...280	90...140
Maximum turn-on voltage	Vrms	90	90	90	90
Maximum turn-off voltage	Vrms	10	10	10	10
Typical input current	mA	2 (120 Vrms), 4 (240 Vrms)	2 (120 Vrms), 4 (240 Vrms)	2 (120 Vrms), 4 (240 Vrms)	15 (120 Vrms)
Output specification					
Operating voltage	~ V	24...280	24...280	24...280	24...280
Load current range	A	10	20	30	45
Transient overvoltage	Vpk	600	600	600	600
Maximum surge current (16.6 ms)	Apk	120	250	625	625
Maximum On-state voltage drop at rated current	Vrms	1.6	1.6	1.6	1.6
Maximum I²t for fusing (8.3 ms)	A²sec	60	260	1620	1620
Maximum off-state leakage current at rated voltage	mA	10	10	10	10
Minimum off-state dv/dt at maximum rated voltage	V/µsec	500	500	500	500
Maximum turn-on time	ms	10 max.	10 max.	10 max.	10 max.
Maximum turn-off time	ms	40 max.	40 max.	40 max.	40 max.
Relay type	SCR output, Zero voltage switching	SSRDCDS10A1	SSRDCDS20A1	SSRDCDS30A1	SSRDCDS45A1
Input specification					
Control voltage range	≡ V	4...32	4...32	4...32	3...32
Maximum turn-on voltage	≡ V	4.0	4.0	4.0	4.0
Maximum turn-off voltage	≡ V	1.0	1.0	1.0	1.0
Typical input current	mA	8...12	8...12	8...12	17
Output specification					
Operating voltage	~ V	24...280	24...280	24...280	24...280
Load current range	A	10	20	30	45
Transient overvoltage	Vpk	600	600	600	600
Maximum surge current (16.6 ms)	Apk	120	250	625	625
Maximum On-state voltage drop at rated current	Vrms	1.6	1.6	1.6	1.6
Maximum I²t for fusing (8.3 ms)	A²sec	60	260	1620	1620
Maximum off-state leakage current at rated voltage	mA	10	10	10	10
Minimum off-state dv/dt at maximum rated voltage	V/µsec	500	500	500	500
Maximum turn-on time	Cycle	1/2	1/2	1/2	1/2
Maximum turn-off time	Cycle	1/2	1/2	1/2	1/2



SSR PCDS25A1



SSR DCDS10A1



SSR DCDS45A1

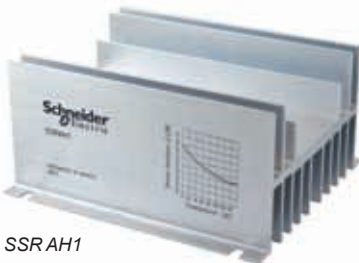

SSR AH1



SSR AT1

Solid state relays, 1 N/O SPST contact

■ Panel mounting

Switching	Voltage range		Load current range	Catalog numbers	Weight	
	Input	Output				
	V	V	A		kg	
SCR output						
Zero voltage switching	~ 3...32	~ 24...280	10	SSRPCDS10A1	0.113	
			25	SSRPCDS25A1	0.113	
			50	SSRPCDS50A1	0.113	
	~ 48...530		75	SSRPCDS75A2	0.113	
		~ 48...660		90	SSRPCDS90A3	0.113
				125	SSRPCDS125A3	0.113
~ 90...280	~ 24...280		10	SSRPP8S10A1	0.113	
			25	SSRPP8S25A1	0.113	
			50	SSRPP8S10A1	0.113	
		75	SSRPP8S75A2	0.113		
		90	SSRPP8S90A3	0.113		
		125	SSRPP8S125A3	0.113		

Mosfet output

DC switching	~ 3.5...32	~ 0...100	12	SSRPCDM12D5	0.113
			25	SSRPCDM25D5	0.113
			40	SSRPCDM40D5	0.113

■ DIN rail mounting

SCR output						
Zero voltage switching	~ 90...280	~ 24...280	10	SSRDP8S10A1	0.272	
			20	SSRDP8S20A1	0.272	
			30	SSRDP8S30A1	0.272	
~ 90...140	~ 24...280	45	SSRDF8S45A1	0.482		
		~ 4...32	~ 24...280	10	SSRDCDS10A1	0.272
				20	SSRDCDS20A1	0.272
		30	SSRDCDS30A1	0.272		
~ 3...32	~ 24...280	45	SSRDCDS45A1	0.482		

Accessories for panel mounted relays

Description	For use with 10...50A relays (1)	Catalog numbers	Weight kg
Heat sink	SSR PP8S●●●●, SSR PCDS●●●●, SSR PCDM●●●●	SSRAH1	0.487
Thermal interface Sold in lots of 10	SSR PP8S●●●●, SSR PCDS●●●●, SSR PCDM●●●●	SSRAT1	0.011

(1) for load current range 75, 90 and 125 A relays, please contact your Customer Care Center.

Solid state relays, 1 N/O SPST contact

■ Panel mounting

Solid state relays SSRP

Thermal interface SSRAT1

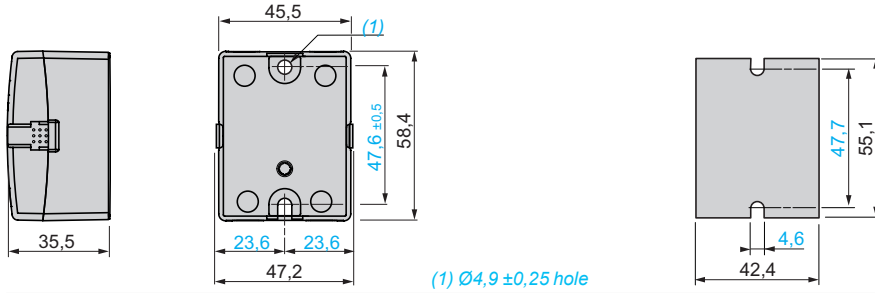

Heat sink SSRAH1

Heat sink dissipation curve

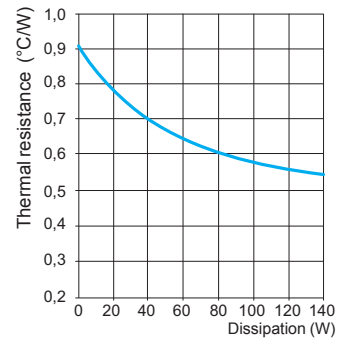
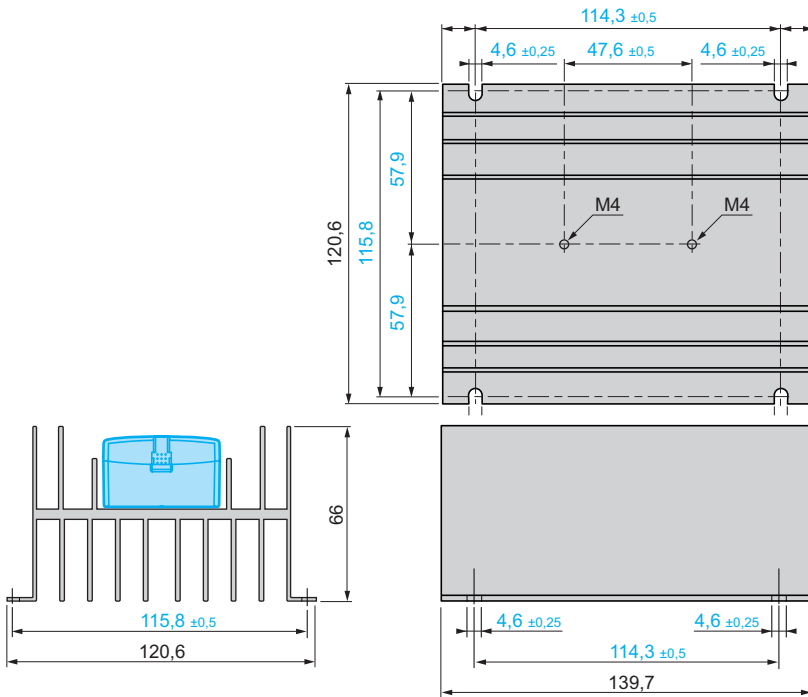

■ DIN rail mounting

10...30 A relays

45 A relays

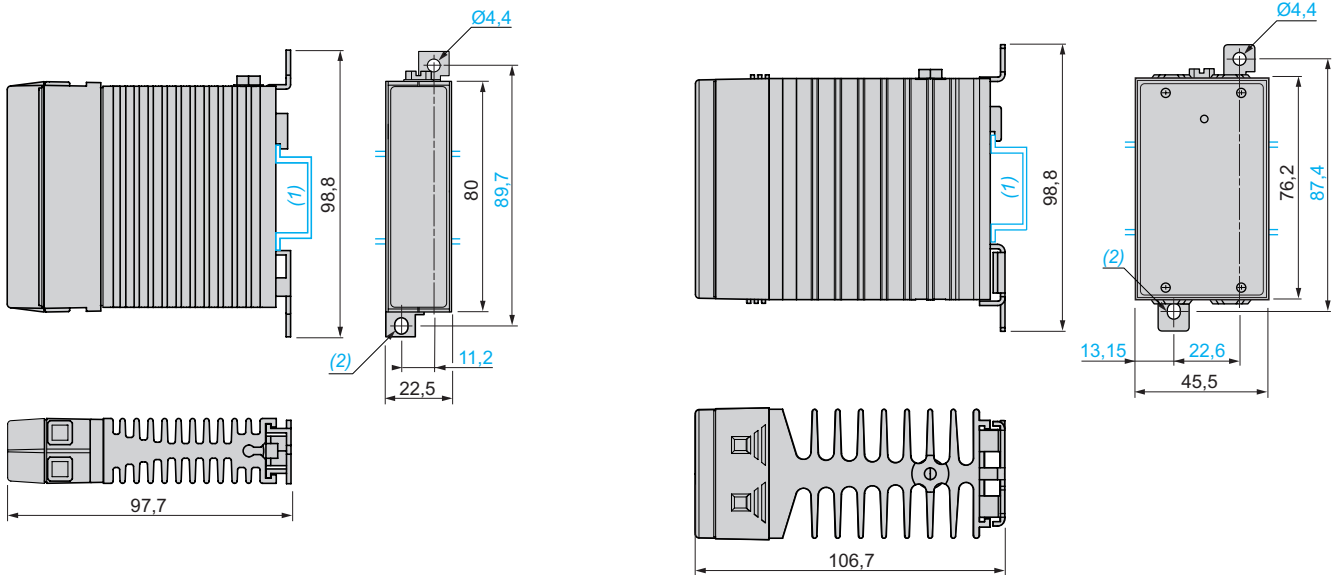

(1) 35 mm DIN rail. (2) Ø 4.4 x 5.5 elongated hole

(1) 35 mm DIN rail. (2) Ø 4.4 x 5.5 elongated hole

Thermal derating curves

■ Panel mounting SSRP relays

□ SCR output

10 A relays

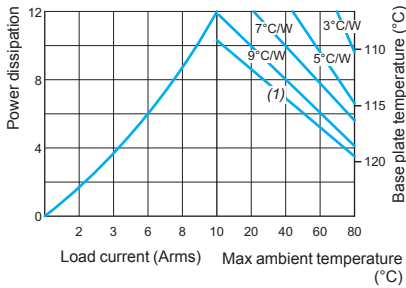

25 A relays

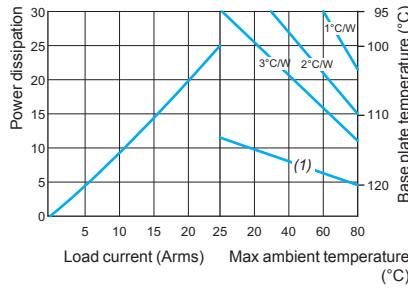

50 A relays

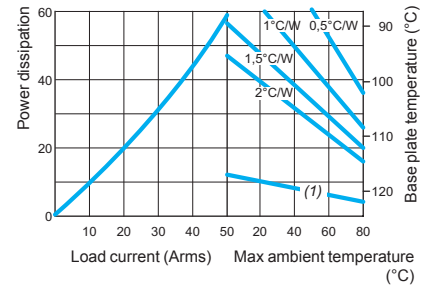

(1) No heat sink

(1) No heat sink

(1) No heat sink

75 A relays

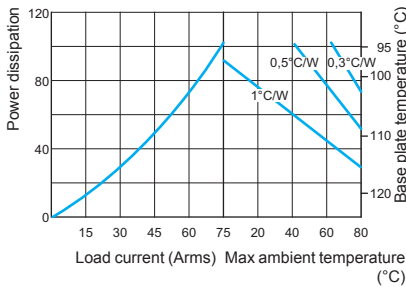

90 A relays

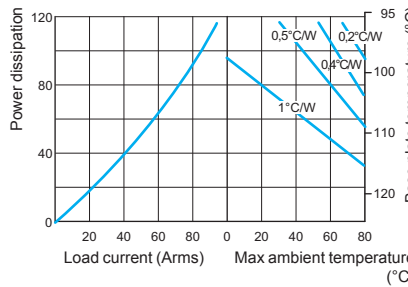

125 A relays

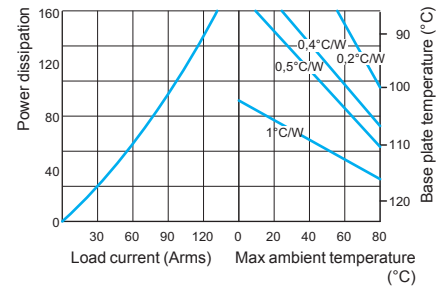

□ Mosfet output

12 A relays

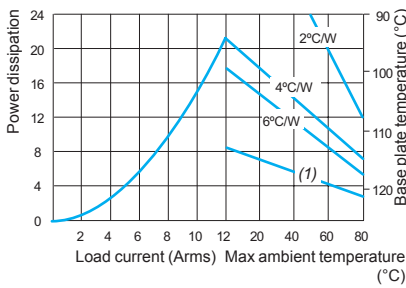

25 and 40 A relays

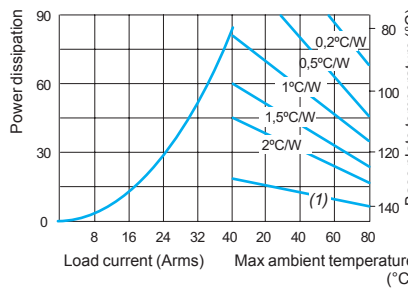

(1) No heat sink

(1) No heat sink

■ Rail mounting SSRD relays

10...45 A relays

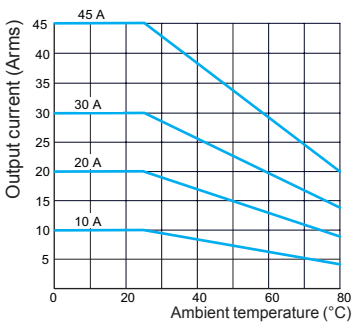

Schneider Electric USA Inc.

8001 Knightdale Blvd.
Knightdale, NC 27545
Tel: 919-266-3671

19 Waterman Avenue
Toronto, Ontario M4B 1Y2
Tel: 416-752-8020

<http://www.schneider-electric.us/>

The information provided in this documentation contains general descriptions and/or technical characteristics of the performance of the products contained herein. This documentation is not intended as a substitute for and is not to be used for determining suitability or reliability of these products for specific user applications. It is the duty of any such user or integrator to perform the appropriate and complete risk analysis, evaluation and testing of the products with respect to the relevant specific application or use thereof. Neither Schneider Electric nor any of its affiliates or subsidiaries shall be responsible or liable for misuse of the information contained herein.

Please note: not all parts listed in this catalog are available in all countries.

Design: Schneider Electric
Photos: Schneider Electric



2010 Electromechanical and solid-state Zelio® Relays



X-ON Electronics

Largest Supplier of Electrical and Electronic Components

Click to view similar products for [General Purpose Relays](#) category:

Click to view products by [Schneider](#) manufacturer:

Other Similar products are found below :

[APF30318](#) [JVN1AF-4.5V-F](#) [PCN-105D3MHZ](#) [5JO-10000S-SIL](#) [5JO-1000CD-SIL](#) [5JO-400CD-SIL](#) [LY2S-AC220/240](#) [LYQ20DC12](#)
[6031007G](#) [6131406HQ](#) [6-1393099-3](#) [6-1393099-8](#) [6-1393122-4](#) [6-1393123-2](#) [6-1393767-1](#) [6-1393843-7](#) [6-1415012-1](#) [6-1419102-2](#) [6-1423698-4](#) [6-1608051-6](#) [6-1608067-0](#) [6-1616170-6](#) [6-1616248-2](#) [6-1616282-3](#) [6-1616348-2](#) [6-1616350-1](#) [6-1616350-8](#) [6-1616358-7](#) [6-1616359-9](#) [6-1616360-9](#) [6-1616931-6](#) [6-1617039-1](#) [6-1617052-1](#) [6-1617090-2](#) [6-1617090-5](#) [6-1617347-5](#) [6-1617353-3](#) [6-1617801-8](#) [6-1617802-2](#) [6-1618107-9](#) [6-1618248-4](#) [M83536/1-027M](#) [CX-4014](#) [MAHC-5494](#) [MAVCD-5419-6](#) [703XCX-120A](#) [7-1393100-5](#) [7-1393111-7](#)
[7-1393144-5](#) [7-1393767-8](#)