



DG34

automotive/ industrial relays

DURAKOOL



- General purpose automotive or industrial relays
- High resistance to inrush current
- For pcb or chassis mounting
- Flat insert faston terminal options
- AC and DC coils
- High Current automotive optimized version available
- Recognitions, certificates, directives: RoHS,   

Contacts

Contact number & arrangement		SPST-NO (1NO), SPST-NC (1NC), SPDT (1 C/O)
Contact material		AgSnOInO, AgCdO
Max. switching voltage		277VAC / 30VDC
Min. switching voltage	AC / DC	10V
Rated Load	AC1	7200VA
	DC1	30A 30V
Min. switching current		10mA
Max. inrush current		80A (SPST-NO), 50A/20A (SPDT)
Rated current		SPST-NO: 30A, SPST-NC: 15A / 277VAC, 10A / 30VDC, SPDT: 20A (NO), 15A (NC)
Max. breaking capacity	AC1	30A
Min. breaking capacity		1W
Resistance		< 50mΩ at 0.1A / 6VDC
Max. operating frequency at rated load	AC1	1200 cycles / hour
		no load 10,000 cycles / hour

Coil

Rated voltage	AC	12... 220VAC 50/60Hz
	DC	5... 110VDC
Must release voltage		AC: $\geq 0.15U_n$ DC: $\geq 0.05U_n$
Operating range of supply voltage		See Tables 1, 2, 3
Rated power consumption		AC: 2VA (approx.) DC: 1W std, 0.9W sensitive

Insulation

Insulation category		C250
Insulation rated voltage		250VAC
Dielectric strength	coil - contact	AC Coils: 1500Vrms / 1min DC Coils: 2500Vrms / 1min
	contact - contact	
	pole - pole	
	1500Vrms / 1 min	
Contact - coil distance	clearance	3 mm
	creepage	3 mm

General data

Operating time (typical value)		$\leq 15\text{msec}$
Release Time		$\leq 15\text{msec}$
Electrical Life	resistive AC1	$> 10^5$
	cos Ø	
Mechanical life		$> 10^7$
Motor Load		2hp (NO), 1hp (NC)
Dimensions (L x W x H)		various - see dimensional drawings
Weight		20...25g
Ambient Temperature	storage	-55... + 130°C
	operating	-55... + 85°C
Cover protection category		IP00, IP40, IP67 depending on version
Shock resistance		20g, 11ms
Vibration resistance		DA 1.5mm, 20-200Hz

Coil Data - standard DC voltage version

Table 1

Coil code	Rated voltage V DC	Coil resistance ± 10% at 20°C Ω	Must Operate Voltage Max VDC	Must Release Voltage Min VDC
1005	5	25	3.75	0.5
1006	6	36	4.50	0.6
1009	9	81	6.75	0.9
1012	12	144	9.00	1.2
1015	15	225	11.25	1.5
1018	18	324	13.50	1.8
1022	22	484	16.50	2.2
1024	24	576	18.00	2.4
1048	48	2304	36.00	4.8
1110	110	12100	82.50	11.0

Coil Data - sensitive 0.9W DC voltage version

Table 2

Coil code	Rated voltage V DC	Coil resistance ± 10% at 20°C Ω	Must Operate Voltage Max VDC	Must Release Voltage Min VDC
S005	5	27	3.75	0.5
S006	6	40	4.50	0.6
S009	9	97	6.75	0.9
S012	12	155	9.00	1.2
S015	15	256	11.25	1.5
S018	18	380	13.50	1.8
S022	22	545	16.50	2.2
S024	24	660	18.00	2.4
S048	48	2560	36.00	4.8
S110	110	13450	82.50	11.0

Standard coil rated voltages marked with bold type, some types may be subject to special order quantities

Coil Temperature Rise - Open Type

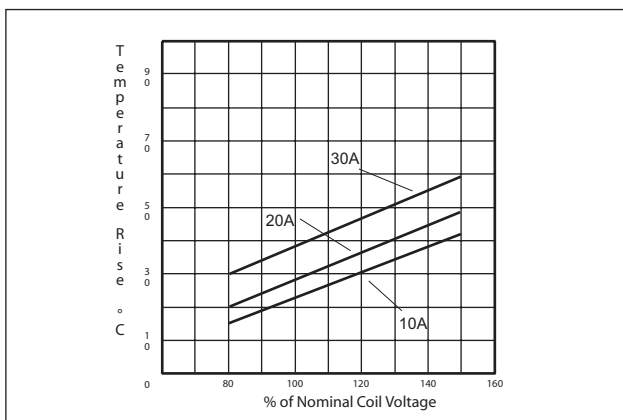

Coil Temperature Rise - Covered type

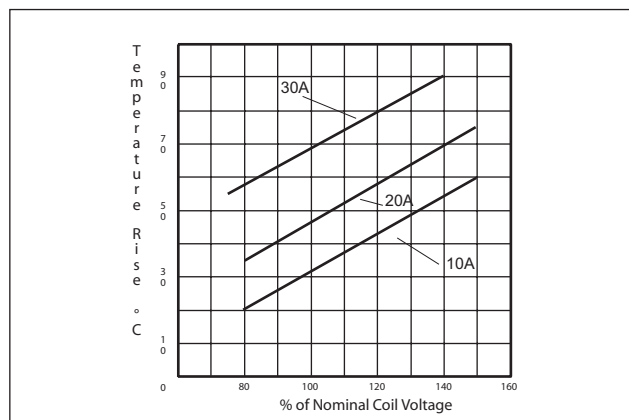

Coil Data - AC 50/60Hz voltage version

Table 3

Coil code	Rated voltage V DC	Coil resistance ± 10% at 20°C Ω	Must Operate Voltage Max VDC	Must Release Voltage Min VDC
5012	5	26	10.2	1.8
5024	6	106	20.4	3.6
5110	9	2750	93.5	16.0
5220	12	11000	187.0	33.0

Ordering Codes

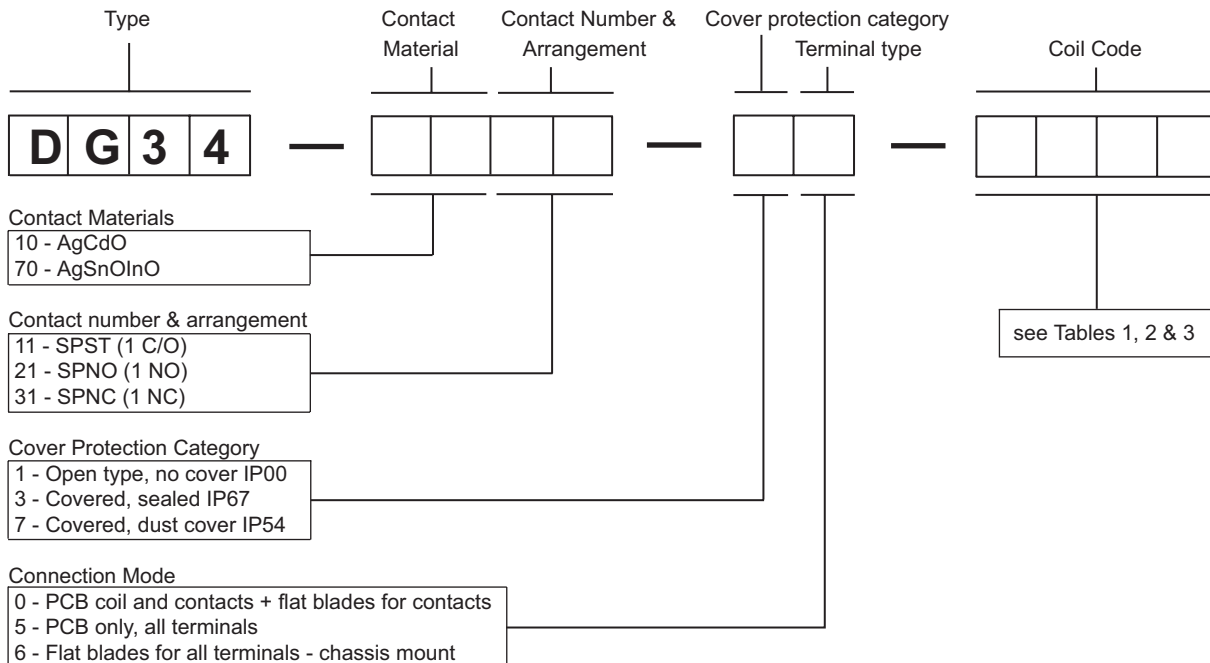

Life Expectancy - Open Type

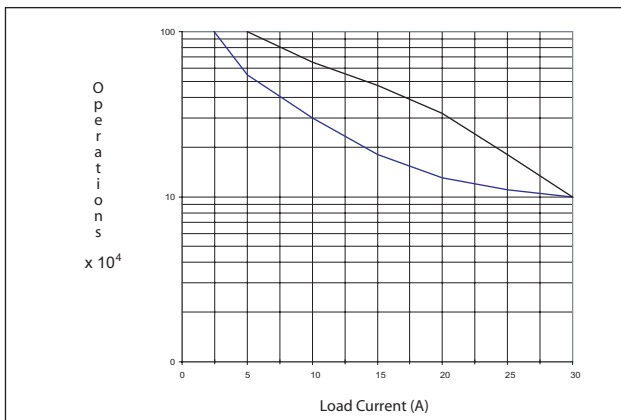

Life Expectancy - Covered type

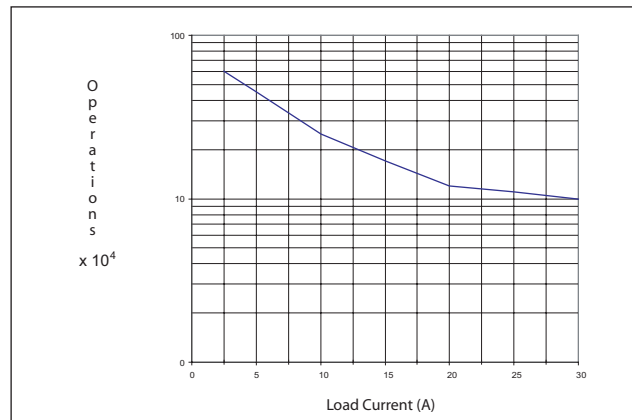

DG34

automotive and industrial relays



Dimensions

Dimensions in mm

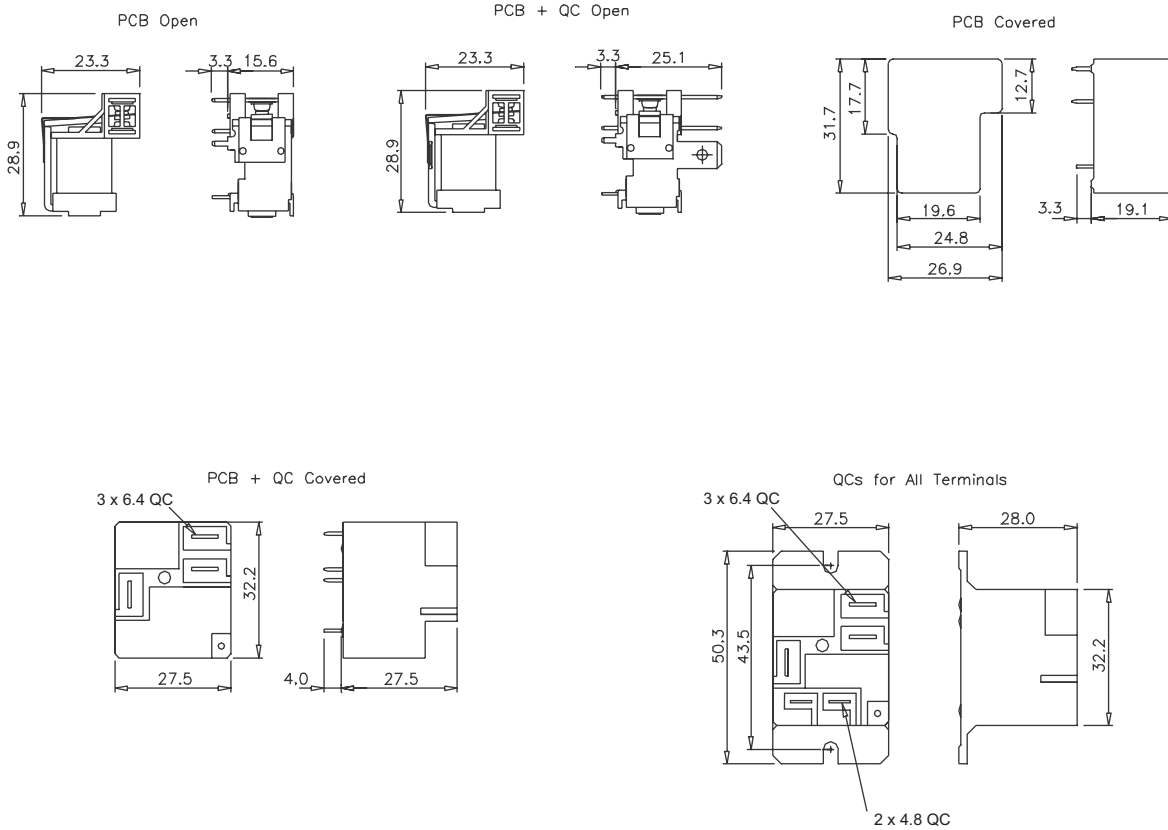

PCB Mounting Holes Dimensions

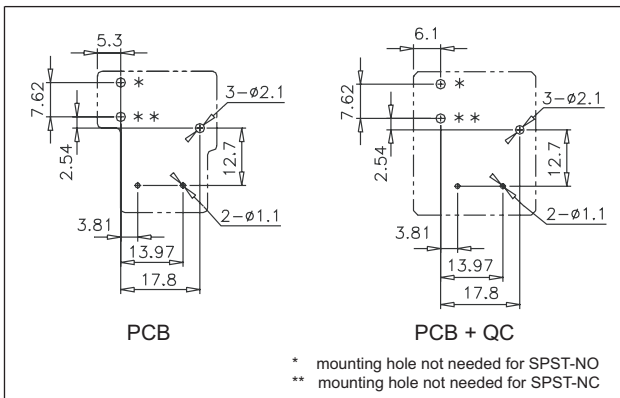

Wiring Diagrams

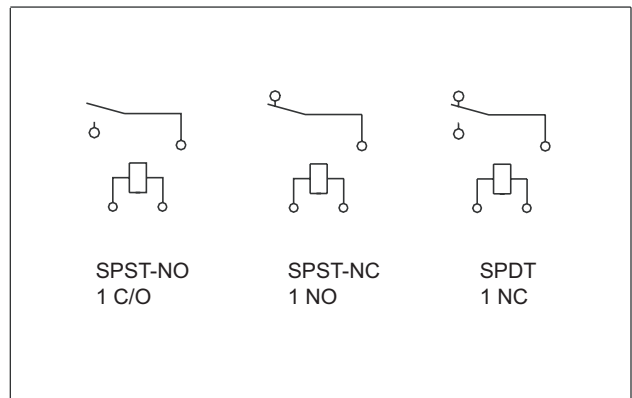

X-ON Electronics

Largest Supplier of Electrical and Electronic Components

Click to view similar products for [durakool](#) manufacturer:

Other Similar products are found below :

[SDA3Z-30K-A](#) [DFC3-301](#) [DG85B-8011-75-1012](#) [DM84-2012-35-1012](#) [DG85C-8021-75-1024](#) [SDA1Z-40K-D](#) [DHS02](#) [DM85-2011-35-1012](#)
[SDA1Z-15K-D](#) [SRA1Z-25K-D](#) [SRA2Z-40K-D](#) [SRA3Z-60K-D](#) [DM84-2012-35-5012](#) [SDA3Z-30K-D](#) [SDA1Z-80K-A](#) [SDA1Z-80K-D](#)
[SRA3Z-80K-D](#) [A1/2-001](#) [DM84-2012-35-1024](#) [SIM212-12VDC](#) [SRA1Z-10K-D](#) [SRA3Z-60K-A](#) [SRA1Z-40K-D](#) [SRA1Z-60K-A](#) [SRA1Z-40K-A](#) [SRA1Z-10K-A](#) [SRA1Z-40L-A](#) [DG85B-8011-76-1024](#) [5002](#) [SRA1Z-25K-A](#) [SIM112 16VDC](#) [SRA1Z-60K-D](#) [DG20-8011-35-1012](#)
[DG85CM-5021-76-1012](#) [SRA1Z-100K-A](#) [DG85B-8011-96-1006-M1](#) [SRA1Z-15L-D](#) [SRA1Z-25L-A](#) [DTP1](#) [SRA1Z-80K-A](#) [SRA1Z-25L-D](#)
[SRA1Z-100K-D](#) [SRA1Z-80L-D](#) [SRA1Z-15L-A](#) [DG85B-8011-96-1012-M1](#) [SRA1Z-100L-D](#) [SRA1Z-40L-D](#) [SRA1Z-60L-A](#) [SRA1Z-80L-A](#)
[SRA1Z-15K-A](#)