





APPROVAL		
Electrical		
Standard	UL	IEC
Rated voltage	300V	250V
Rated current	10A	18A
Wire range	26-14AWG	0.5-2.5mm ²
Withstanding voltage	AC2000V/1Min	
Menchanical		
torque	0.4Nm(3.5Lb-In)	
Ambient temperature	-40°C~+105 °C	
Strip length	6-7mm	
Dimensions		
pitch	5.0mm(.197")	
Poles	2P,3P-24P	
Material		
Housing	PA66,UL94V-0	
Screws	M2.5,steel, Cr ³⁺ Znplated	
Pin header	Brass,Tin plated	
Wire guard	Stainless steel	



HOW TO ORDER :

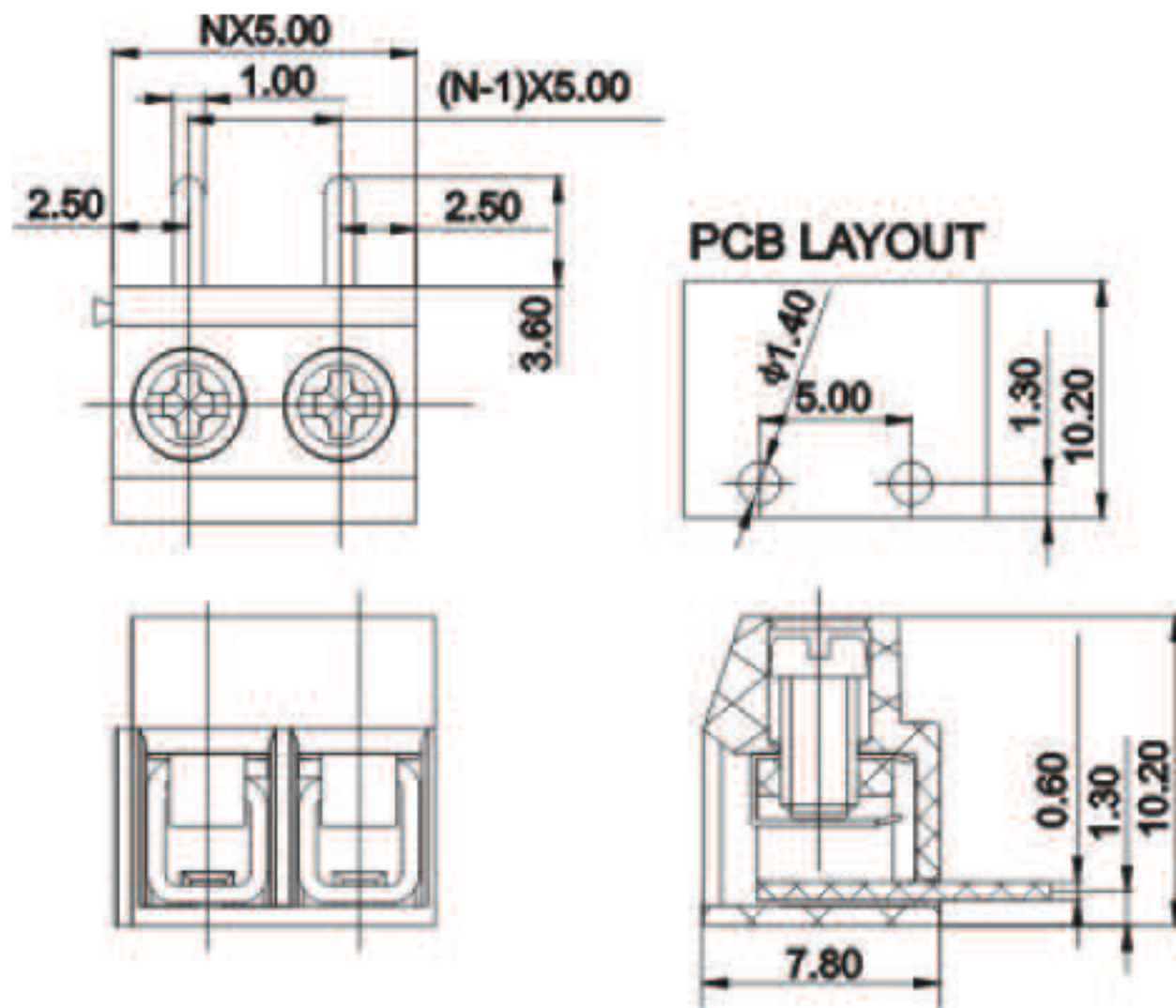
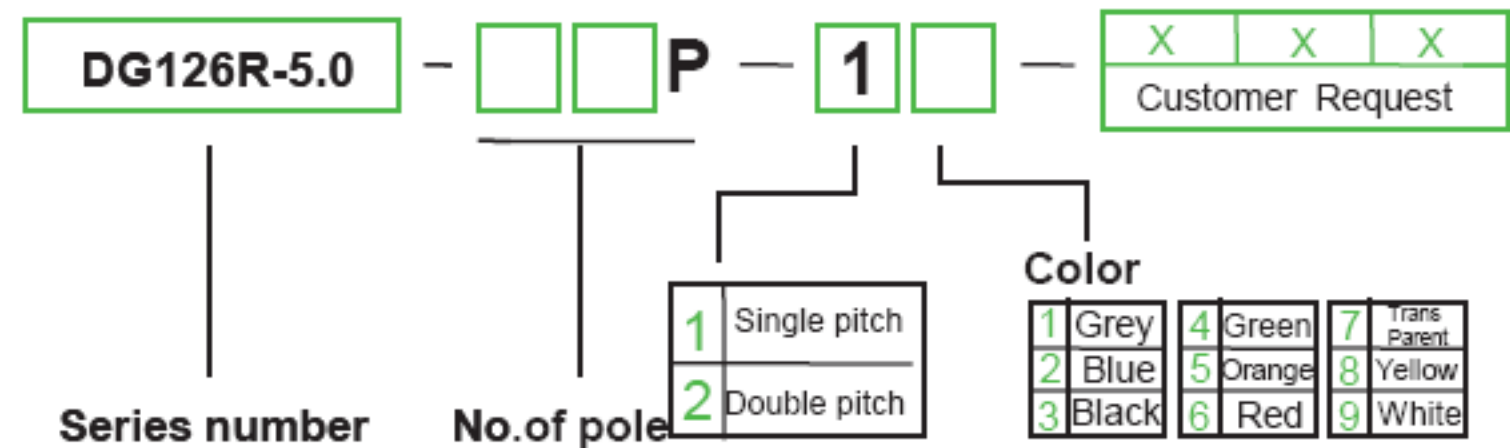
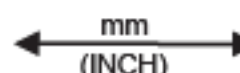

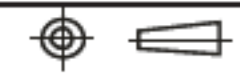
 mm (INCH)	 DEGSON ELECTRONICS CO., LTD.
 THIROANGLE PROJECTION	NAME DG126R-5.0

X-ON Electronics

Largest Supplier of Electrical and Electronic Components

Click to view similar products for [Pluggable Terminal Blocks](#) category:

Click to view products by [Degson](#) manufacturer:

Other Similar products are found below :

[57.404.7553](#) [57.504.0053.7](#) [57.510.0053](#) [57.910.6153](#) [01.112.1453](#) [CTB932VE/6](#) [MC 1.5/ 6-ST-3.5 GY AU](#) [ET02015000J0G](#) [734-104](#) [734-302](#) [734-304](#) [8-141-P](#) [FKCT 2.5/ 3-ST KMGY](#) [860505](#) [860508](#) [860516](#) [860810](#) [861908](#) [GBPACX-12](#) [93.731.4953.0](#) [PV05-5,08-K](#) [PVP02-5,00](#) [PVP04-3,50](#) [PVS02-5,00](#) [1-1986160-3](#) [H-10](#) [1546228-5](#) [ELFH09150](#) [ELFH16150](#) [ELFP03110](#) [ELFT06250](#) [ELFT07250](#) [ELVF09400](#) [ELVP03100](#) [ELXH03100](#) [ELXH071G0E](#) [ELXP041G0](#) [ELXT046G0](#) [1700101](#) [1700410](#) [1700425](#) [1703176](#) [1703243](#) [1705229](#) [1710175](#) [1714537](#) [1717806](#) [1719600](#) [1728941](#) [1729386](#)