

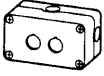
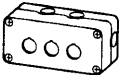
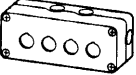
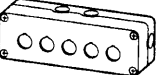

RMQ 22

Surface Mounting Enclosures

Control Circuit Devices

	Number of locations	Cable entry knockouts		Max. number of lamps in simultaneous operation	Type	Price See Price List	Std. pack
		Bottom	Sides:				
	Quantity	Quantity × PG...		Max.	Article no.		Colour ¹⁾
Surface mounting enclosure IP 65 <small>totally insulated</small>							
With moulded cover fixing screws Cannot be used to mount: EC..., BFT..., BCE(L) 24							
Emergency-stop button	1	1×13.5	3×16	-	IGE1M 081696		1 off
	1	1×13.5	3×16	1	I1M 038834		
	2	2×13.5	3×16	2	I2M 041207		
	3	2×13.5	4×16	2	I3M 043580		
	4	2×13.5	4×16	3	I4M 045953		
	5	2×13.5	4×16	4	I5M 048326		
One-way screws							
For securing enclosure against tampering							
					ES-IM 050699		4 off
					ES-IGE 060244		4 off
Surface mounting enclosure IP 65 <small>totally insulated</small>							
With quick-release fastener for cover and base plate for EK...C Enclosure pebble grey Cannot be used to mount: EC..., BFT..., BCE(L) 24							
	12 ²⁾	-	1×21/16 ²⁾ 4 2×29/16 ²⁾		I12M 053072		1 off

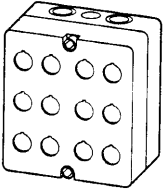
Notes

- ¹⁾ Colour: Yellow RAL 1004, enclosure cover light grey RAL 7032, enclosure base anthracite RAL 7016
- ²⁾ Cable entry at top and bottom

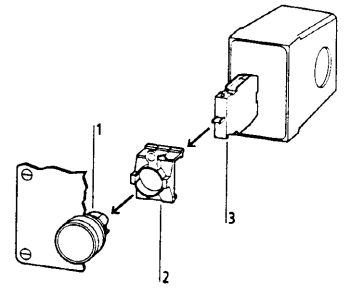
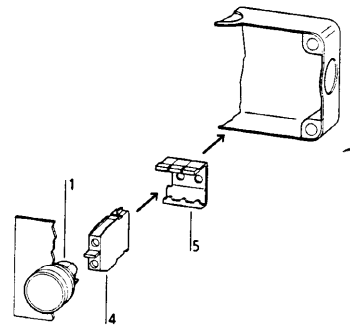
Style: flush mounting**Style: surface mounting**

Accessories	Page
1 Actuator	03/014
2 Fixing adapter	03/036
3 Contact element	03/036
4 Contact element	03/037
5 Fixing adapter	03/037
Button plate	03/044
Legend plate	03/052
Accessories	03/057

For networking

AS interface	01/046
--------------	--------

X-ON Electronics

Largest Supplier of Electrical and Electronic Components

Click to view similar products for [eaton](#) manufacturer:

Other Similar products are found below :

[BK-MDL-3-R](#) [BK1-S506-500-R](#) [BK1-S506-6-3-R](#) [BK1-S506-2-R](#) [MPI4040R4-1R5-R](#) [TDC600-10A](#) [89096-015](#) [8946K153](#) [8961K155](#)
[M22-DL-W-X0](#) [M22-D-R-GB0/K11](#) [M22-L-R/R](#) [M22S-ST-GB12](#) [630NHG3B](#) [63ET](#) [6422](#) [6580](#) [CTX20-16-52LP-R](#) [CWL530FI](#)
[CXM/CO/GP/R/BB](#) [6HD36](#) [714125](#) [MBO-2](#) [ESR5-NO-41-24VAC-DC](#) [7314K36](#) [7321K2](#) [F02A-1-1/2A](#) [F02A-1-1/2AS](#) [F02A-1AS](#) [F02A-2AS](#) [F02A-3/4A](#) [F03A250V12A](#) [F03B125V4A](#) [MCR-4](#) [MDA-2-8/10-R](#) [MDA-30A](#) [MDA-V-1/16](#) [F60C500V10AS](#) [F60C500V15AS](#)
[7563K84](#) [7634K36](#) [MDQ-3/16](#) [MDQ-7/10](#) [MDQ-V-1/10](#) [MDQ-V-1-1/4](#) [MDQ-V-1/16](#) [MDQ-V-1/2](#) [MDQ-V-1/4](#) [MDQ-V-3/16](#) [MDQ-V-3/8](#)