

Advanced Contact Technology

**Multi-Contact**

**MC**

STÄUBLI GROUP

**Solar***line*

Steckverbinder für erneuerbare Energie  
Connectors for Renewable Energy

## **Anschlusssysteme und Zubehör für die Photovoltaik** **Connection systems and accessories for photovoltaics**

Steckverbinder, Anschlussdosen & Kabel  
Plug connectors, junction boxes & cables





## MC Kontaktlamellentechnik: Grenzenlose Möglichkeiten

Kontaktlamellen sind speziell geformte, widerstandsfähige Geometrien aus Kupferlegierung, je nach Anwendung versilbert oder vergoldet und in einen Einstich schwimmend montiert. Der konstante Federdruck der Lamelle sorgt für eine permanente Kontaktierung mit der Kontaktoberfläche und daraus resultiert ein geringer und konstanter Durchgangswiderstand.

Die Kontaktlamellentechnik ermöglicht uns, eine Vielzahl von Lösungen anzubieten und selbst härteste Bedingungen zu erfüllen, sowohl elektrisch (bis zu mehreren kA), thermisch (bis zu 350°C) als auch mechanisch, mit Kontaktbeständigkeit bis zu 1 Million Steckzyklen.

Wir sind auf die Entwicklung und Fertigung kundenspezifischer Lösungen spezialisiert.

## MC Multilam Technology: unlimited possibilities

Multilams are specially formed, resilient strips of copper alloy which are silver or gold-plated according to their application and are float mounted in a groove. By its constant spring pressure the Multilam maintains continuous contact with the contact surface, resulting in a low and constant contact resistance.

Multilam technology allows us to meet a very broad range of requirements and to find solutions to the most severe constraints, including electrical (up to several kA), thermal (up to 350°C) and mechanical, with contact durability of up to 1 million mating cycles.

We are specialised in the design of custom solutions.

## Die richtige Technologie für höchste Anforderungen.

The right technology for the strictest requirements.

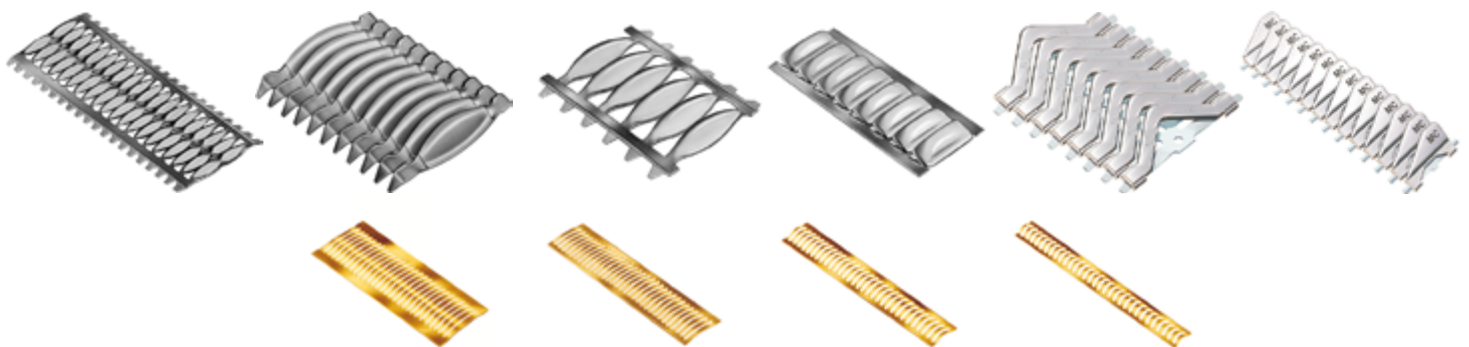



## Vorteile der Kontaktlamellentechnik

- Minimaler Spannungsabfall
- Hohe Stromtragfähigkeit
- Minimaler Energieverlust
- Minimaler Durchgangswiderstand
- Kontakte mit hoher Lebensdauer bis zu 1 Million Steckzyklen
- Betriebstemperaturen bis 350°C, kurzzeitig sind höhere Temperaturen möglich
- Unempfindlich gegenüber Ölen
- Hohe Schlag-, Stoss- und Rüttelfestigkeit
- Geringe Wartungskosten
- Runde, flache und sphärische Geometrien
- Sehr gute Korrosionsbeständigkeit

## Advantages of Multilam Technology

- Minimal voltage drop
- High current-carrying capacity
- Minimal power loss
- Minimal contact resistance
- High durability contacts withstand up to 1 million mating cycles
- Operating temperatures up to 350°C, higher temperatures permitted for short periods
- Good resistance to oils
- High resistance to vibration, shock and impact
- Low maintenance costs
- Round, flat or spherical types
- Very good corrosion resistance

Auszug aus dem Katalog **MultilamTechnology**

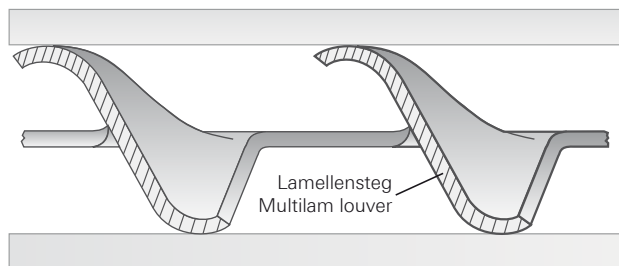





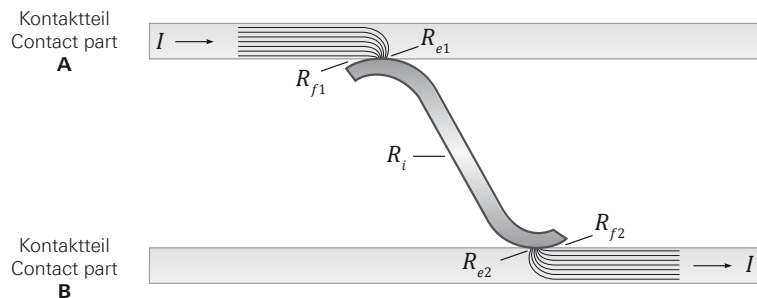



$R_{e1}/R_{e2}$  = Engewiderstand  
 $R_i$  = Innenwiderstand des Lamellensteges  
 $R_{f1}/R_{f2}$  = Fremdschichtwiderstand  
 $I$  = Nennstrom

Extract from catalogue **MultilamTechnology**

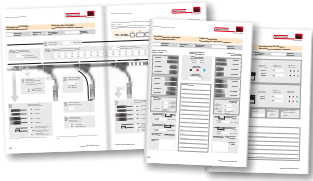

$R_{e1}/R_{e2}$  = Constriction resistance  
 $R_i$  = Internal resistance of louver  
 $R_{f1}/R_{f2}$  = Film resistance  
 $I$  = Nominal current

Inhalt	Content		
6 – 7		<b>Einführung</b> Einsatzmöglichkeiten Vorteile der MC PV-Produkte	<b>Introduction</b> Range of applications Advantages of MC PV products
8 – 29		<b>Steckverbinder</b> Übersicht Produkt-Spezifikationen	<b>Plug connectors</b> Overview Product specifications
30 – 45		<b>Anschlussdosen</b> Übersicht Produkt-Spezifikationen	<b>Junction boxes</b> Overview Product specifications
46 – 49		<b>Leitungen</b> FLEX-SOL-XL Stringleitung	<b>Cables</b> FLEX-SOL-XL Branch cable
50 – 55		<b>Zubehör</b>	<b>Accessories</b>
56 – 63		<b>Montagewerkzeuge</b>	<b>Assembly tools</b>
64 – 70		<b>Formulare</b> Formulare für kundenspezifische Produkte	<b>Forms</b> Forms for customer-specific products
71 – 75		<b>Anhang</b> Technische Hinweise Alphabetischer Index	<b>Appendix</b> Technical information Alphabetical index

## Sicherheitshinweis

Nicht von MC hergestellte Steckverbindungen, die mit MC Elementen steckbar sind und von den Herstellern manchmal auch als "MC kompatibel" bezeichnet werden, entsprechen nicht den Anforderungen für eine sichere, langzeitstabile elektrische Verbindung und dürfen aus Sicherheitsgründen nicht mit MC Elementen gesteckt werden. Wir übernehmen deshalb keine Haftung, falls diese von MC nicht freigegebenen Steckverbindungen mit MC Elementen gesteckt werden.

## Allgemeine Angaben

### Farbcode

Für Artikel die in mehreren Farben erhältlich sind, schreiben Sie anstelle des im Katalog angegebenen Zeichens „\*“ den zweistelligen Farbcode hinter die Bestell-Nummer.

grün-gelb	schwarz	rot	blau	gelb	grün	violett	braun	grau	weiss	transparent
20	21	22	23	24	25	26	27	28	29	33

### Änderungen/Vorbehalte

Alle Daten, Abbildungen und Zeichnungen in diesem Katalog sind das Resultat sorgfältiger Prüfungen. Sie entsprechen dem Stand unserer Erfahrungen. Irrtum vorbehalten. Ebenfalls vorbehalten sind Änderungen aus konstruktions- bzw. sicherheitstechnischen Gründen. Bei der Entwicklung von Geräten in denen unsere Bauteile eingebunden werden, sollte vor Verwendung der Katalogdaten mit uns abgeklärt werden, ob die Daten dem aktuellen Stand entsprechen. Wir beraten Sie gerne.

### Urheberrecht

Die Weiterverwendung dieser Katalogunterlagen in jedweder Form ohne unsere vorherige schriftliche Genehmigung ist nicht gestattet.

### RoHSready

Richtlinie 2011/65/EU zur Beschränkung der Verwendung bestimmter gefährlicher Stoffe in Elektro- und Elektronikgeräten.

### Symbole

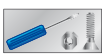

Zu diesem Produkt gibt es Zubehör oder spezielle Werkzeuge



Zu diesem Produkt ist die Montageanleitung **MA000** verfügbar



Zu diesem Produkt sind interaktive Inhalte vorhanden

## Safety note

Plug connectors that are not made by MC but can be mated with MC elements and are sometimes also described by their manufacturers as "MC compatible", do not conform to the requirements for a safe electrical connection with long-term stability and for safety reasons may not be plugged together with MC elements. We therefore accept no liability if these connectors which are not approved by MC are mated with MC elements.

## General information

### Colour code

For those items available in various colours, replace the asterisk "\*" with the appropriate colour code.

green-yellow	black	red	blue	yellow	green	violet	brown	grey	white	transparent
20	21	22	23	24	25	26	27	28	29	33

### Changes/Provisos

All data, illustrations and drawings in the catalogue have been carefully checked. They are in accordance with our experience to date, but no responsibility can be accepted for errors. We also reserve the right to make modifications for design and safety reasons. When designing equipment incorporating our components, it is therefore advisable not to rely solely on the data in the catalogue but to consult us to make sure this information is up to date. We shall be pleased to advise you.

### Copyright

The use of this catalogue for any other purpose, in whatever form, without our prior written consent is not permitted.

### RoHSready

Directive 2011/65/EC on the restriction of the use of certain hazardous substances in electrical and electronic equipment.

### Symbols



Accessories or special tools exist for this product



The assembly instruction **MA000** is available for this product



Check out the interactive content for this product

## Einsatzmöglichkeiten des MC Produktportfolios

Beispiel einer PV-Aufdachanlage, mit MC4 Steckverbinder-system, Anschlussdose Westlake und Stringleitung.

## Application possibilities of the MC product portfolio

Example of a PV roof installation with MC4 plug connector system, Westlake junction box and branch cable.



Beispiele einer PV-Feldinstallation.

Das obere Beispiel zeigt das MC3 Steckverbindersystem und die zweipolige PV-JB-LC. Darunter ist das MC4 Steckverbindersystem und die einpolige PV-JB/LP zu sehen.

Examples of a PV field installation

The upper example shows the MC3 plug connector system and the two-pole PV-JB-LC. The MC4 connector system and the single-pole PV-JB/LP can be seen below.

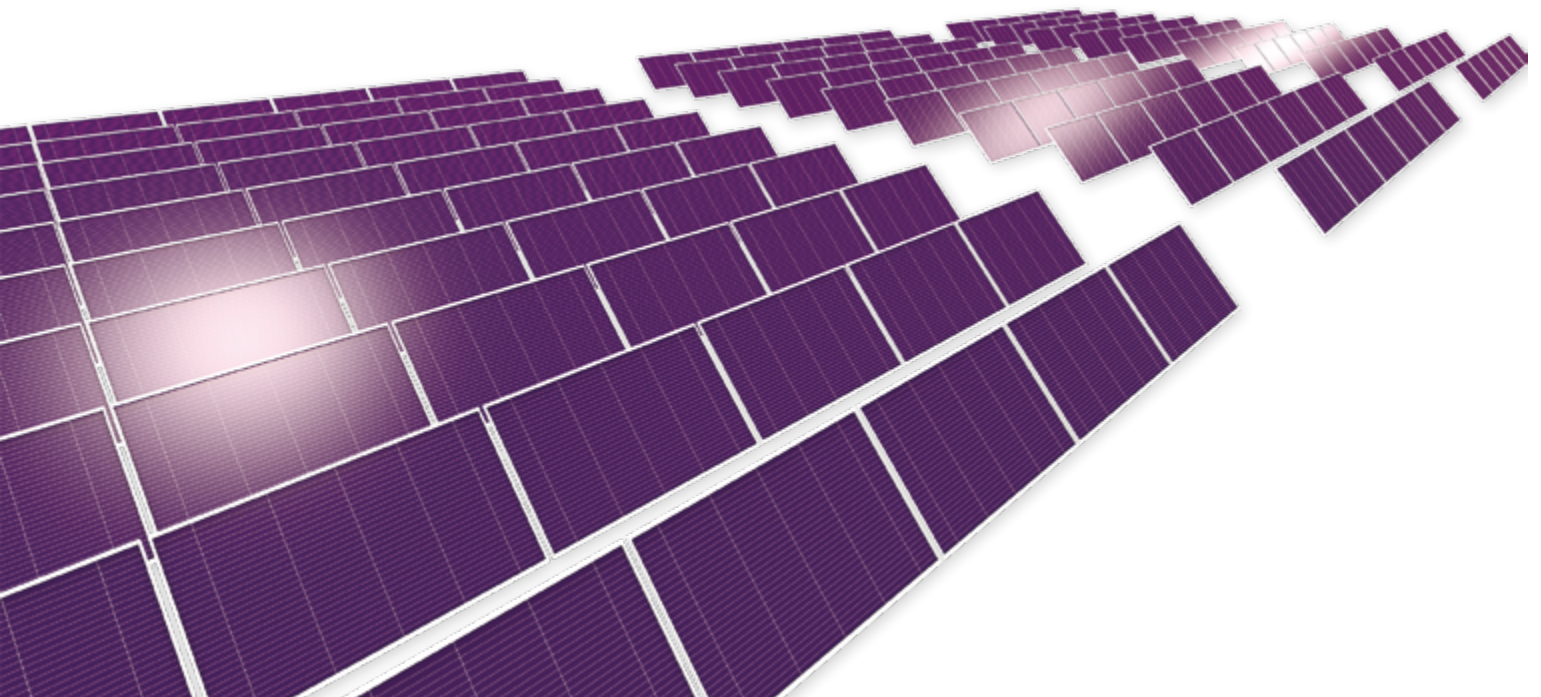
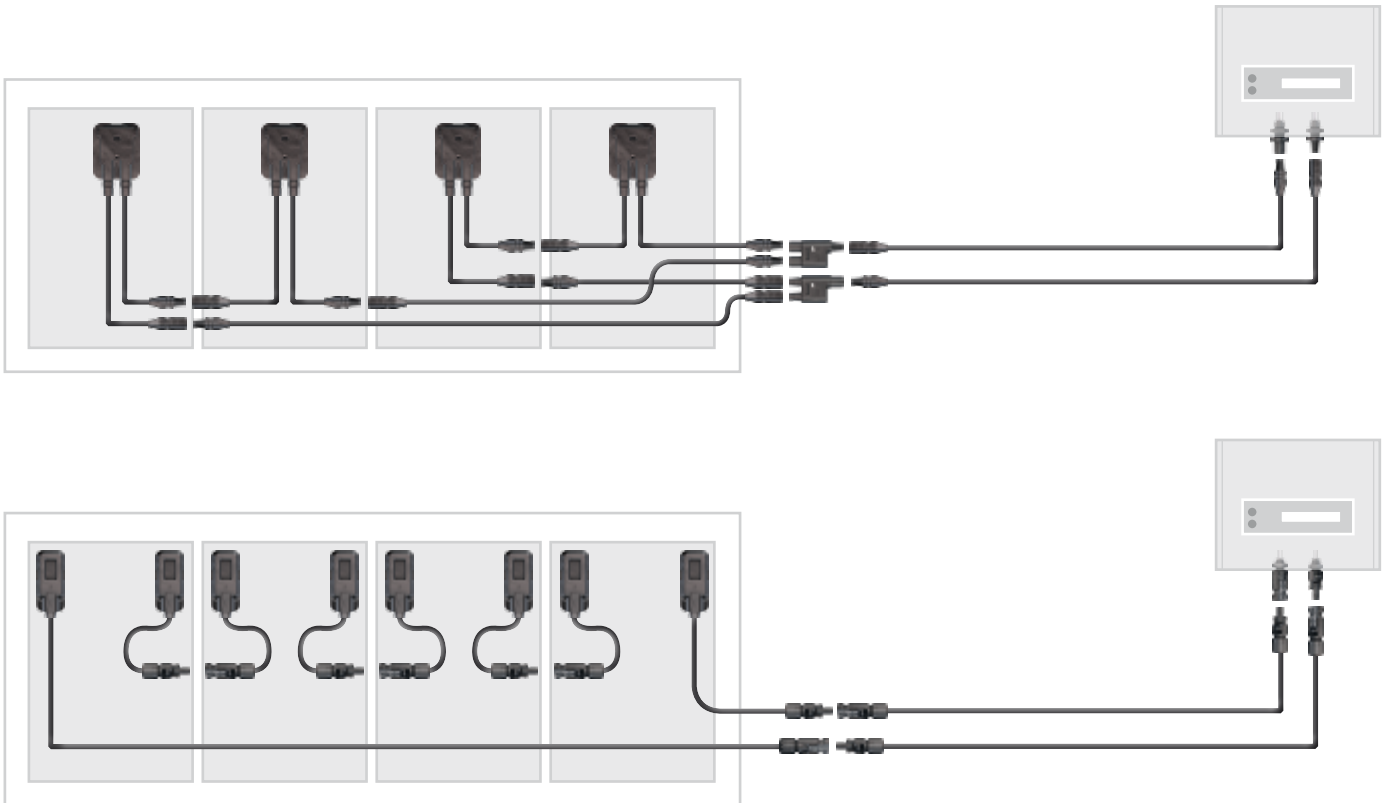

**Vorteile der MC Steckverbinder**

**Advantages of the MC connectors**



**Bewährte, langzeitstabile MC Lamellentechnologie**  
Proven Multilam technology with high long-term stability

**Mehr als 40 Jahre Erfahrung und Kernkompetenz**  
More than 40 years of experience and core competence

**Verschiedene Leiterquerschnitte**  
Range of cable cross-sections

10mm <sup>2</sup>	○		
6mm <sup>2</sup>	○	○	10AWG
4mm <sup>2</sup>	○	○	12AWG
2,5mm <sup>2</sup>	○	○	14AWG
1,5mm <sup>2</sup>	○		

**FLEX-SOL-XL**  
**BETAflam®**  
**RADOX**

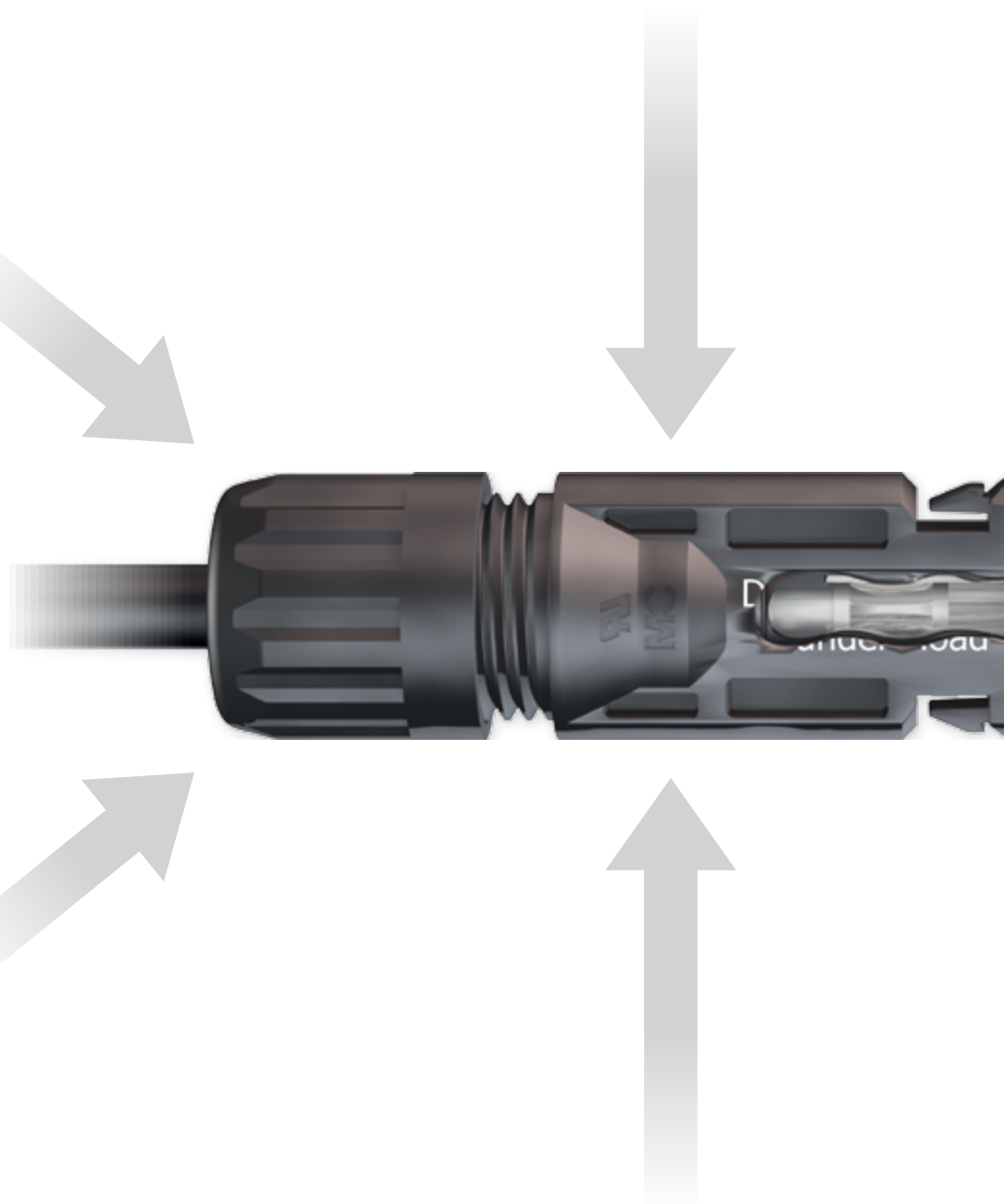



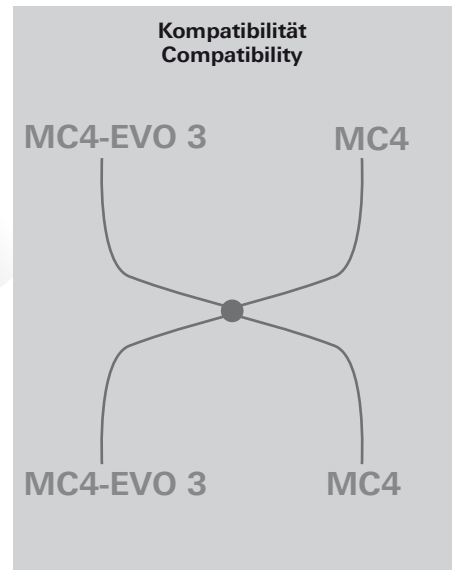
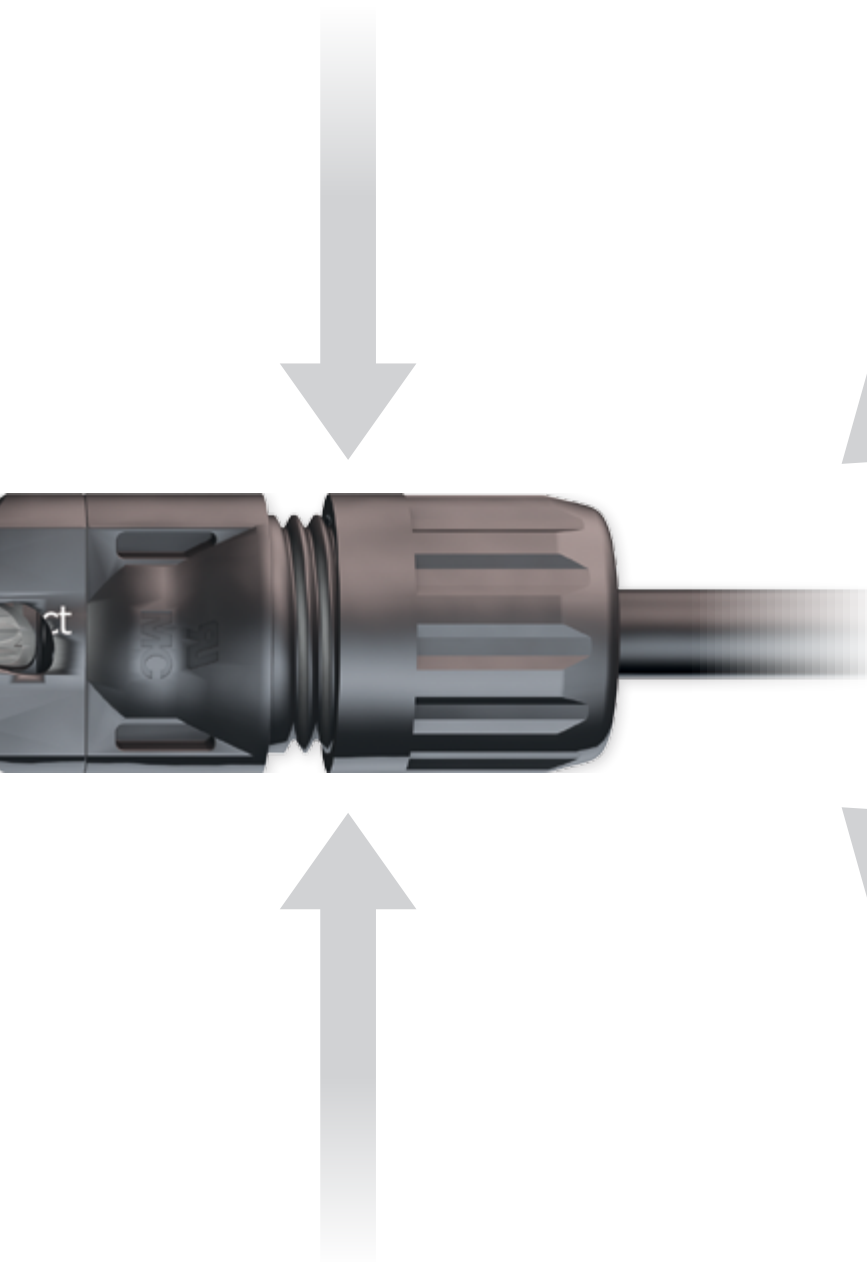

**Zertifikate**  
**Certificates**

	BAUART GEPRÜFT TYPE APPROVED	TÜV
		UL recognized
		GOST-R
		CSA









**Übersicht Steckverbinder**





**Overview of plug connectors**

	Zulassungen <sup>1)</sup> Approvals <sup>1)</sup>
--	--





**Steckverbinder/Plug connectors**

<b>MC3</b>		
<b>MC4</b>		
<b>MC4-EVO 3</b>		

**Aufbaudosensteckverbinder/Panel receptacles**

<b>MC3</b>		
<b>MC4</b>		



**Abzweigsteckverbinder/Branch connectors**









<b>MC3</b>		
<b>MC4</b>		

<sup>1)</sup> Zulassungen sind teilweise auf bestimmte Typen begrenzt oder in Bearbeitung. Details auf den jeweiligen Produktseiten.

<sup>1)</sup> Certifications are in some cases limited to specific types or still pending. Details are given on the relevant product pages.

**Zeichenerklärung/Legend**

-  Konfektionierung **mit** Werkzeug  
Assembly **with** tool
-  Konfektionierung **ohne** Werkzeug  
Assembly **without** tool
-  Ab Werk vorkonfektioniert erhältlich  
Available as ready-assembled product

Eigenschaften Features	Salznebelprüftest Salt mist spray test	Bemessungsstrom Rated current	Bemessungsspannung Rated voltage			Verriegelungssystem Locking system	Schutzart Degree of protection		Schutzklasse Safety class	Umgebungstemperatur Ambient temperature range	Verschlusskappen Sealing caps	Seite Page
			Kategorie Category	TÜV (V DC)	UL (V DC)		MC (V DC)	gesteckt mated				
   	V	20/30/43	1000	600	1000	–	IP67	IP2X	II	-40...+90	x	<b>12</b>
   	VI	17/22,5/30/43	1000	600	1000	Snap-in	IP67 IP68	IP2X	II	-40...+90	x	<b>14 16</b>
 	V	17/22/30	1500 <sup>2)</sup>	1000	1500	Snap-in	IP65 IP67 IP68	IP2X	II	-40...+85	x	<b>18</b>
  	–	20/30	1000	–	1000	–	IP65	IP2X	II	-40...+85	x	<b>20</b>
  	–	17/22,5/30	1000	–	1000	Snap-in	IP67	IP2X	II	-40...+90	x	<b>22 24</b>
	–	30	–	600	1000	–	IP65	IP2X	II	-40...+90	x	<b>26</b>
	–	30	–	–	1000	Snap-in	IP67	IP2X	II	-40...+90	x	<b>28</b>

<sup>2)</sup> Die Isolationsanforderungen für einen Betrieb bei 1500V DC werden erfüllt. Ein Zertifikat kann erst erstellt werden, sobald es ein für diese Bemessungsspannung zertifiziertes PV Kabel gibt.

<sup>2)</sup> The insulation requirements for operation at 1500V DC are fulfilled. A certificate can be issued as soon as a PV cable certified for this rated voltage is available.

 Vor Ort zu konfektionieren  
For assembly on site

 Kundenspezifisch konfektionierbar  
Suitable for customer-specific assembly

## Kupplungsbuchse, -stecker MC3

**Kupplungsbuchsen und -stecker als Einzelteil**  
(inklusive Isoliereteil)

PV-KBT3...



PV-KST3...



## Female and male cable coupler MC3

**Female and male cable coupler as individual part**  
(including insulating part)

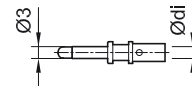
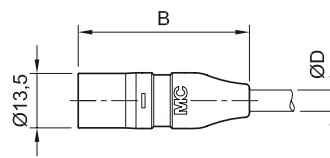
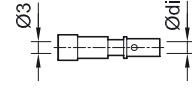
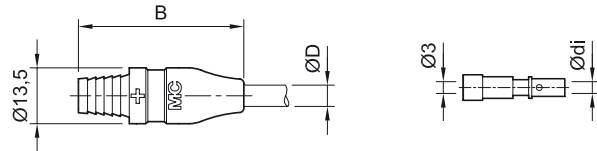

### Technische Daten

Technische Daten	Technical data	
Steckverbindersystem	Connector system	Ø 3mm
Bemessungsspannung	Rated voltage	1000V DC (IEC) 600V DC (UL)
Bemessungsstrom	Rated current	20A (2,5mm <sup>2</sup> , 4mm <sup>2</sup> ; 14AWG, 12AWG) 30A (6mm <sup>2</sup> ; 10AWG) 43A (10mm <sup>2</sup> )
Prüfspannung	Test voltage	6kV (50Hz, 1min.)
Umgebungstemperaturbereich	Ambient temperature range	-40°C...+90°C (IEC) -40°C...+75°C (UL)
Obere Grenztemperatur	Upper limiting temperature	105°C (IEC)
Schutzart, gesteckt ungesteckt	Degree of protection, mated unmated	IP67 IP2X
Überspannungskat./Verschmutzungsgrad	Overvoltage category/Pollution degree	CATIII/3
Kontaktwiderstand der Steckverbinder	Contact resistance of plug connectors	≤ 0,5mΩ
Schutzklasse	Safety class	II
Kontaktsystem	Contact system	MC Kontaktlamellen MC Multilam
Anschlussart	Type of termination	Crimpen Crimping
Kontaktmaterial	Contact material	Kupfer, verzinkt Copper, tin plated
Isolationsmaterial	Insulation material	TPE/PA
Steckkraft/Auszugskraft	Insertion force/Withdrawal force	≤ 50N/≥ 50N
Flammklasse	Flame class	UL94-HB/UL94-V0
Salznebelprüfetest, Schärfeegrad 5	Salt mist spray test, degree of severity 5	IEC 60068-2-52
TÜV-Zertifiziert	TÜV certified	R60026534
UL-Zulassung	UL-Recognized	E343181
CSA-Zertifiziert	CSA certified	250725



**Verschlusskappen** Seite 54  
**Montagegeräte** Seite 58, 59

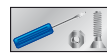

**Sealing caps** page 54  
**Assembly tools** page 58, 59



Montageanleitung **MA207**  
[www.multi-contact.com](http://www.multi-contact.com)



Assembly Instructions **MA207**  
[www.multi-contact.com](http://www.multi-contact.com)







**Das Original**

- Erster PV Serien-Steckverbinder auf dem Weltmarkt
- Bewährte, langzeitstabile MC Lamellentechnologie
- Millionenfach verbaut, seit 14 Jahren im Einsatz
- Auch für Querschnitte von 10mm<sup>2</sup> konfektionierbar
- Auch erhältlich als konfektionierte Leitungen, siehe Seite 66
- Leitungen nach Kundenwunsch, siehe Seite 68

**The original**

- First series PV plug connector on the world market
- Proven Multilam technology with high long-term stability
- Has been installed millions of times over 14 years
- Available for assembly with cross sections of 10mm<sup>2</sup>
- Also available as ready made leads, see page 66
- Leads made to customer's specifications, see page 68



Typ Type	Bestell-Nr. Order No.	Kupplungsbuchse Female cable coupler	Kupplungsstecker Male cable coupler	Kabelmantaussendurchmesser Cable outer diameter		Leiterquerschnitt Conductor cross section		Ø di (mm)	Montagegerät Assembly device		Zulassungen Approvals
				B (mm)	Ø D (mm)	mm <sup>2</sup>	AWG		PV-RWZ3	PV-AWZ3	
PV-KBT3I-UR	32.0000-UR	x		40	3,2 – 4,8	2,5; 4	14; 12; 10	3	x <sup>1)</sup>	x	     
PV-KST3I-UR	32.0001-UR		x	41,6	3,2 – 4,8	2,5; 4	14; 12; 10	3	x <sup>1)</sup>	x	
PV-KBT3II-UR	32.0002-UR	x		40	4,9 – 7,1	2,5; 4	14; 12; 10	3	x <sup>1)</sup>	x	
PV-KST3II-UR	32.0003-UR		x	41,6	4,9 – 7,1	2,5; 4	14; 12; 10	3	x <sup>1)</sup>	x	
PV-KBT3III-UR	32.0004-UR	x		50	6,5 – 9 <sup>1)</sup>	2,5; 4	14; 12; 10	3	x <sup>1)</sup>	x	
PV-KST3III-UR	32.0005-UR		x	51,6	6,5 – 9 <sup>1)</sup>	2,5; 4	14; 12; 10	3	x <sup>1)</sup>	x	
PV-KBT3/6III-UR	32.0006-UR	x		50	6,5 – 9 <sup>1)</sup>	6		4	x <sup>1)</sup>	x	
PV-KST3/6III-UR	32.0007-UR		x	51,6	6,5 – 9 <sup>1)</sup>	6		4	x <sup>1)</sup>	x	
PV-KBT3/6IIA	32.0062	x		51,6	4,9 – 7,1	6		4		x	
PV-KST3/6IIA	32.0063		x	51,6	4,9 – 7,1	6		4		x	
PV-KBT3IV	32.0032	x		50	6,5 – 9	10		5		x	
PV-KST3IV	32.0033		x	51,6	6,5 – 9	10		5		x	

<sup>1)</sup> Für UL zugelassene Produkte darf nur das Montagegerät PV-RWZ3 verwendet werden. Kabel mit Aussendurchmesser bis 7,6mm können damit montiert werden.

<sup>1)</sup> For UL-certified products, only assembly tool PV-RWZ3 may be used. It may be used for the assembly of cables with an outside diameter of up to 7,6mm.

**Kupplungsbuchse, -stecker  
MC4**

**Female and male cable coupler  
MC4**

**Kupplungsbuchsen und -stecker als Einzelteil**  
(inklusive Isoliereteil)

**Female and male cable coupler as individual part**  
(including insulating part)

**PV-KBT4...**

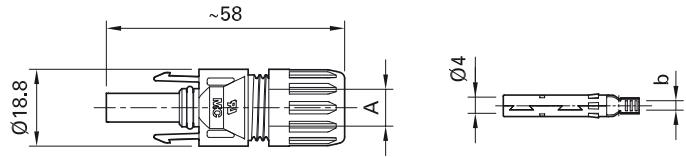
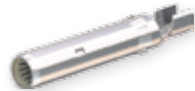

**PV-KST4...**

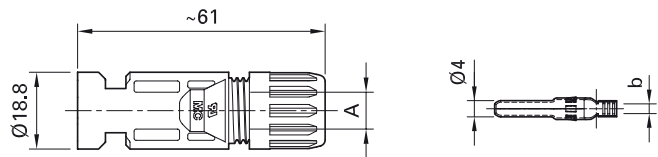

**Technische Daten**

**Technical data**

Steckverbindersystem	Connector system	<b>Ø 4mm</b>
Bemessungsspannung	Rated voltage	<b>1000V DC (IEC) 600V DC (UL)</b>
Bemessungsstrom IEC (90°C)	Rated current IEC (90°C)	<b>17A (1,5mm<sup>2</sup>) 22,5A (2,5mm<sup>2</sup>; 14AWG) 30A (4mm<sup>2</sup>, 6mm<sup>2</sup>; 10AWG) 43A (10mm<sup>2</sup>)</b>
Bemessungsstrom IEC (85°C)	Rated current IEC (85°C)	<b>39A (4mm<sup>2</sup>; 10AWG) 45A (6mm<sup>2</sup>; 10AWG)</b>
Prüfspannung	Test voltage	<b>6kV (50Hz, 1min.)</b>
Umgebungstemperaturbereich	Ambient temperature range	<b>-40°C...+90°C (IEC) -40°C...+75°C (UL) -40°C...+70°C (UL: 14AWG)</b>
Obere Grenztemperatur	Upper limiting temperature	<b>105°C (IEC)</b>
Schutzart, gesteckt ungesteckt	Degree of protection, mated unmated	<b>IP67, IP68 (1h/1m) IP2X</b>
Überspannungskat./Verschmutzungsgrad	Overvoltage category/Pollution degree	<b>CATIII/3</b>
Kontaktwiderstand der Steckverbinder	Contact resistance of plug connectors	<b>0,35mΩ</b>
Schutzklasse	Safety class	<b>II</b>
Kontaktsystem	Contact system	<b>MC Kontaktlamellen/MC Multilam</b>
Anschlussart	Type of termination	<b>Crimpen/Crimping</b>
Kontaktmaterial	Contact material	<b>Kupfer, verzinkt/Copper, tin plated</b>
Isolationsmaterial	Insulation material	<b>PC/PA</b>
Verriegelungssystem	Locking system	<b>Snap-in</b>
Flammklasse	Flame class	<b>UL94-V0</b>
Ammoniakbeständigkeit (gemäss DLG)	Ammonia resistance (acc. to DLG)	<b>1500h, 70°C/70% RH, 750ppm</b>
Salznebelprühtest, Schärfegrad 6	Salt mist spray test, degree of severity 6	<b>IEC 60068-2-52</b>
TÜV-Zertifiziert	TÜV certified	<b>R60028286</b>
UL-Zulassung	UL-Recognized	<b>E343181</b>
CSA-Zertifiziert	CSA certified	<b>250725</b>

**Sicherungshülse** Seite 53  
 **Verschlusskappen** Seite 55  
 **Montageschlüsselset** Seite 61



**Safety lock clip** page 53  
 **Sealing caps** page 55  
 **Assembly tools** page 61

**Montageanleitung MA231**  
[www.multi-contact.com](http://www.multi-contact.com)

**Assembly Instructions MA231**  
[www.multi-contact.com](http://www.multi-contact.com)

- Snap-In Verriegelung
  - Durch Einsatz der Sicherungshülse PV-SSH4 Verriegelung nach NEC 2011, nur mit Werkzeug entriegelbar
  - Bewährte, langzeitstabile MC Lamellentechnologie
  - Bewährter Steckverbinder
  - Auch für Querschnitte von 10mm<sup>2</sup> konfektionierbar
  - Auch erhältlich als konfektionierte Leitungen, siehe Seite 66
  - Leitungen nach Kundenwunsch, siehe Seite 68
- Snap-in locking
  - Locking by safety lock clip PV-SSH4 in accordance with NEC 2011, can be released only with tool
  - Proven MC-Multilam technology with high long-term stability
  - Tried and tested plug connectors
  - Available for assembly with cross-sections of 10mm<sup>2</sup>
  - Also available as ready made leads, see page 66
  - Leads made to customer's specifications, see page 68



Typ Type	Bestell-Nr. Order No.	Kupplungsbuchse Female cable coupler	Kupplungsstecker Male cable coupler	Ø-Bereich Kabelverschraubung Ø range of cable gland	Leiterquerschnitt Conductor cross section			Zulassungen Approvals
					mm <sup>2</sup>	AWG	b (mm)	
PV-KBT4/2,5I-UR	32.0010P0001-UR	×		3 – 6	1,5; 2,5	14	3	  
PV-KST4/2,5I-UR	32.0011P0001-UR		×	3 – 6	1,5; 2,5	14	3	
PV-KBT4/2,5II-UR	32.0012P0001-UR	×		5,5 – 9	1,5; 2,5	14	3	
PV-KST4/2,5II-UR	32.0013P0001-UR		×	5,5 – 9	1,5; 2,5	14	3	
PV-KBT4/6I-UR	32.0014P0001-UR	×		3 – 6	4; 6	10	5	
PV-KST4/6I-UR	32.0015P0001-UR		×	3 – 6	4; 6	10	5	
PV-KBT4/6II-UR	32.0016P0001-UR	×		5,5 – 9	4; 6	10	5	
PV-KST4/6II-UR	32.0017P0001-UR		×	5,5 – 9	4; 6	10	5	
PV-KBT4/10II	32.0034P0001	×		5,5 – 9	10	–	7,2	
PV-KST4/10II	32.0035P0001		×	5,5 – 9	10	–	7,2	

**Kupplungsbuchse, -stecker MC4** **Female and male cable coupler MC4**

**Kontakte auf Trägerband**  
(inklusive Isoliereteil)

PV-KBT4...  
PV-KST4...



**Contacts on carrier band**  
(including insulating part)

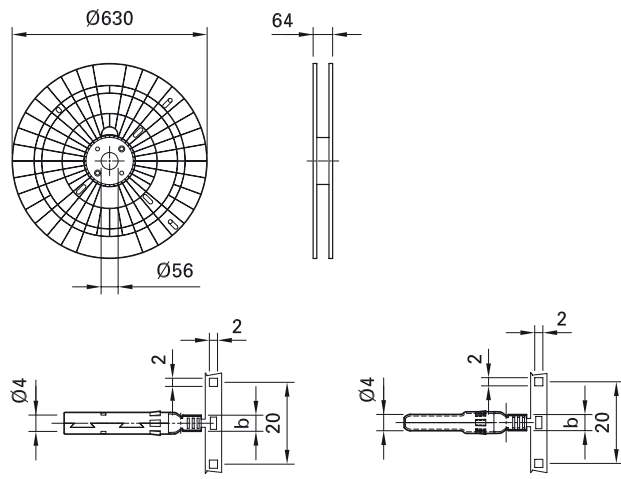

Technische Daten	Technical data	
Steckverbindersystem	Connector system	<b>Ø 4mm</b>
Bemessungsspannung	Rated voltage	<b>1000V DC (IEC) 600V DC (UL)</b>
Bemessungsstrom IEC (90°C)	Rated current IEC (90°C)	<b>17A (1,5mm<sup>2</sup>) 22,5A (2,5mm<sup>2</sup>; 14AWG) 30A (4mm<sup>2</sup>, 6mm<sup>2</sup>; 10AWG) 43A (10mm<sup>2</sup>)</b>
Bemessungsstrom IEC (85°C)	Rated current IEC (85°C)	<b>39A (4mm<sup>2</sup>; 10AWG) 45A (6mm<sup>2</sup>; 10AWG)</b>
Prüfspannung	Test voltage	<b>6kV (50Hz, 1min.)</b>
Umgebungstemperaturbereich	Ambient temperature range	<b>-40°C...+90°C (IEC) -40°C...+75°C (UL) -40°C...+70°C (UL: 14AWG)</b>
Obere Grenztemperatur	Upper limiting temperature	<b>105°C (IEC)</b>
Schutzart, gesteckt ungesteckt	Degree of protection, mated unmated	<b>IP67, IP68 (1h/1m) IP2X</b>
Überspannungskat./Verschmutzungsgrad	Overvoltage category/Pollution degree	<b>CATIII/3</b>
Kontaktwiderstand der Steckverbinder	Contact resistance of plug connectors	<b>0,35mΩ</b>
Schutzklasse	Safety class	<b>II</b>
Kontaktsystem	Contact system	<b>MC Kontaktlamellen/MC Multilam</b>
Anschlussart	Type of termination	<b>Crimpen/Crimping</b>
Kontaktmaterial	Contact material	<b>Kupfer, verzinnt/Copper, tin plated</b>
Isolationsmaterial	Insulation material	<b>PC/PA</b>
Verriegelungssystem	Locking system	<b>Snap-in</b>
Flammklasse	Flame class	<b>UL94-V0</b>
Ammoniakbeständigkeit (gemäss DLG)	Ammonia resistance (acc. to DLG)	<b>1500h, 70°C/70% RH, 750ppm</b>
Salznebelprühtest, Schärfegrad 6	Salt mist spray test, degree of severity 6	<b>IEC 60068-2-52</b>
TÜV-Zertifiziert	TÜV certified	<b>R60028286</b>
UL-Zulassung	UL-Recognized	<b>E343181</b>
CSA-Zertifiziert	CSA certified	<b>250725</b>

**Sicherungshülse** Seite 53  
 **Verschlusskappen** Seite 55  
 **Montageschlüsselset** Seite 61

**Safety lock clip** page 53  
 **Sealing caps** page 55  
 **Assembly tools** page 61





**Montageanleitung MA231**  
[www.multi-contact.com](http://www.multi-contact.com)

**Assembly Instructions MA231**  
[www.multi-contact.com](http://www.multi-contact.com)

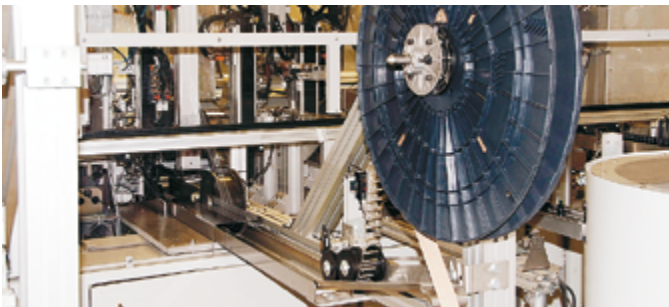

- Trägerbänder zur voll automatischen Konfektionierung
- Speziell für MC4 ausgelegte Werkzeugeinsätze für automatisierte Crimpung erhältlich
- Prozesssicherheit durch speziell entwickeltes Rollendepot
- Feeder bands for fully automatic assembly
- Tools specially designed for MC4 are available for automatic crimping
- Process reliability as result of specially developed supply reel



Typ Type	Bestell-Nr. Order No.	Kupplungsbuchse Female cable coupler	Kupplungsstecker Male cable coupler	Ø-Bereich Kabelverschraubung Ø range of cable gland	Leiterquerschnitt Conductor cross section			Crimpwerkzeug Crimping tool	Kontakte pro Rolle <sup>2)</sup> Contacts per reel <sup>2)</sup>	Zulassungen Approvals
					mm <sup>2</sup>	AWG	b (mm)			
PV-KBT4/2,5I-UR	32.0010P2000-UR	×		3 – 6	1,5; 2,5	14	3	<sup>1)</sup>	2000	  
PV-KST4/2,5I-UR	32.0011P2000-UR		×	3 – 6	1,5; 2,5	14	3	<sup>1)</sup>	2000	
PV-KBT4/2,5II-UR	32.0012P2000-UR	×		5,5 – 9	1,5; 2,5	14	3	<sup>1)</sup>	2000	
PV-KST4/2,5II-UR	32.0013P2000-UR		×	5,5 – 9	1,5; 2,5	14	3	<sup>1)</sup>	2000	
PV-KBT4/6I-UR	32.0014P2000-UR	×		3 – 6	4; 6	10	5	<sup>1)</sup>	2000	
PV-KST4/6I-UR	32.0015P2000-UR		×	3 – 6	4; 6	10	5	<sup>1)</sup>	2000	
PV-KBT4/6II-UR	32.0016P2000-UR	×		5,5 – 9	4; 6	10	5	<sup>1)</sup>	2000	
PV-KST4/6II-UR	32.0017P2000-UR		×	5,5 – 9	4; 6	10	5	<sup>1)</sup>	2000	
PV-KBT4/10II	32.0034P1700	×		5,5 – 9	10	–	7,2	<sup>1)</sup>	1700	
PV-KST4/10II	32.0035P1700		×	5,5 – 9	10	–	7,2	<sup>1)</sup>	1700	

<sup>1)</sup> Informationen zu halbautomatischem Crimpgerät oder Montagegerät auf Anfrage

<sup>2)</sup> Rollentyp vorbehalten

<sup>1)</sup> Information about a semi-automatic crimp device or assembly device on request

<sup>2)</sup> Reel type subject to alterations

## Kupplungsbuchse, -stecker MC4-EVO 3

Vorkonfektioniert mit Kabel

MC-K.../PV-PLS-B...

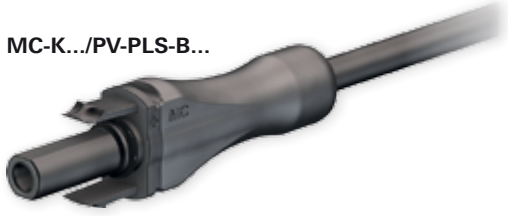

MC-K.../PV-PLS-S...



## Female and male cable coupler MC4-EVO 3

Ready-made with cable

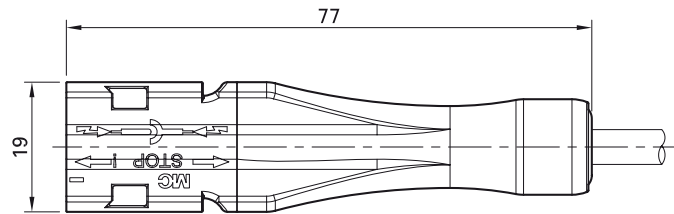
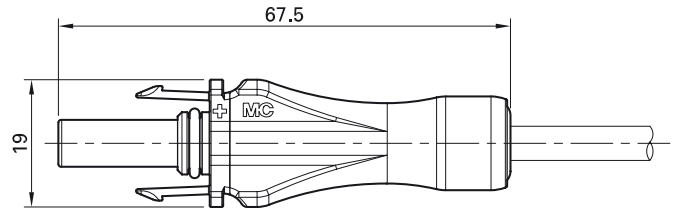

### Technische Daten

Steckverbindersystem

Bemessungsspannung

Bemessungsstrom

Prüfspannung

Umgebungstemperaturbereich

Obere Grenztemperatur

Schutzart, gesteckt  
ungesteckt

Überspannungskat./Verschmutzungsgrad

Kontaktwiderstand der Steckverbinder

Schutzklasse

Kontaktsystem

Kontaktmaterial

Isolationsmaterial

Verriegelungssystem

Flammklasse

Salznebelprüfetest, Schärfegrad 5

TÜV-Zertifiziert

UL-Zulassung

### Technical data

Connector system

Rated voltage

Rated current

Test voltage

Ambient temperature range

Upper limiting temperature

Degree of protection, mated  
unmated

Overvoltage category/Pollution degree

Contact resistance of plug connectors

Safety class

Contact system

Contact material

Insulation material

Locking system

Flame class

Salt mist spray test, degree of severity 5

TÜV certified

UL-Recognized

Ø 4mm

1000V/1500V DC (IEC)  
600V/1000V DC (UL)

17A (1,5mm<sup>2</sup>)  
22A (2,5mm<sup>2</sup>; 14AWG)  
30A (4mm<sup>2</sup>, 6mm<sup>2</sup>; 12AWG, 10AWG)

8kV (50Hz, 1min.)

-40°C...+85°C (IEC)  
-40°C...+70°C (UL)

+105°C (IEC)

IP65, IP67, IP68 (1h/1m)  
IP2X

CATIII/3

0,35mΩ

II

MC Kontaktlamellen  
MC Multilam

Messing, verzinkt  
Brass, tin plated

PPE/TPE

Snap-in

UL-94-V0

IEC 60068-2-52

R60035159

E343181



**Verschlusskappen** Seite 55  
**Entriegelungsschlüssel** Seite 61



**Sealing caps** page 55  
**Unlocking tool** page 61

- Das neuartige, integrierte Dichtungssystem garantiert hohe Schutzklassen von IP65, IP67 und IP68 (1h/1m).
- Verriegelung der Steckverbinder nach NEC 2011 durch integrierten Snap-in-Verschluss für höchste Anschlusssicherheit, nur mit Werkzeug PV-MS-PLS entriegelbar.
- Steckkompatibel mit MC4.
- Vorkonfektioniert erhältlich mit den Leiterquerschnitten 2,5mm<sup>2</sup>, 4mm<sup>2</sup> und 6mm<sup>2</sup>.
- The innovative integrated sealing system guarantees high protection categories of IP65, IP67 and IP68 (1h/1m).
- The connector can be locked in conformity with NEC 2011 by an integrated snap-in latch for maximum dependability, and can be unlocked only with the tool PV-MS-PLS.
- Compatible for mating with MC4.
- Only available pre-assembled with the conductor cross sections 2,5mm<sup>2</sup>, 4mm<sup>2</sup> and 6mm<sup>2</sup>.

Typ Type	Bestell-Nr. Order No.	Leitungsende Cable end	Leitungstyp Cable type	Leitungsende Cable end	Leiterquerschnitt Conductor cross section		Bemessungsstrom Rated current	Leitungsfarbe Colour of cable	Zulassungen Approvals
					mm <sup>2</sup>	AWG			
MC-K2,5SXL/PV-PLS-BI/-/...	32.1161-1)*	×	FLEX-SOL-XL 2,5		2,5	14	22	21	
MC-K2,5SXL/PV-PLS-SI/-/...	32.1162-1)*		FLEX-SOL-XL 2,5	×	2,5	14	22		
MC-K2,5SXL/PV-PLS-BI/PV-PLS-SI/...	32.1163-2)*	×	FLEX-SOL-XL 2,5	×	2,5	14	22		
MC-K4SXL/PV-PLS-BII/-/...	32.1164-1)*	×	FLEX-SOL-XL 4,0		4,0	12	30		
MC-K4SXL/PV-PLS-SII/-/...	32.1165-1)*		FLEX-SOL-XL 4,0	×	4,0	12	30		
MC-K4SXL/PV-PLS-BII/PV-PLS-SII/...	32.1166-2)*	×	FLEX-SOL-XL 4,0	×	4,0	12	30		
MC-K6SXL/PV-PLS-BIII/-/...	32.1167-1)*	×	FLEX-SOL-XL 6,0		6,0	10	30		
MC-K6SXL/PV-PLS-SIII/-/...	32.1168-1)*		FLEX-SOL-XL 6,0	×	6,0	10	30		
MC-K6SXL/PV-PLS-BIII/PV-PLS-SIII/...	32.1169-2)*	×	FLEX-SOL-XL 6,0	×	6,0	10	30		
MC-K2,5BE/PV-PLS-BII/-/...	32.1170-1)	×	BETAflam®		2,5	14	22		
MC-K2,5BE/PV-PLS-SII/-/...	32.1171-1)		BETAflam®	×	2,5	14	22		
MC-K2,5BE/PV-PLS-BII/PV-PLS-SII/...	32.1172-2)	×	BETAflam®	×	2,5	14	22		
MC-K4BE/PV-PLS-BIII/-/...	32.1173-1)	×	BETAflam®		4,0	12	30		
MC-K4BE/PV-PLS-SIII/-/...	32.1174-1)		BETAflam®	×	4,0	12	30		
MC-K4BE/PV-PLS-BIII/PV-PLS-SIII/...	32.1175-2)	×	BETAflam®	×	4,0	12	30		
MC-K6BE/PV-PLS-BIII/-/...	32.1176-1)	×	BETAflam®		6,0	10	30		
MC-K6BE/PV-PLS-SIII/-/...	32.1177-1)		BETAflam®	×	6,0	10	30		
MC-K6BE/PV-PLS-BIII/PV-PLS-SIII/...	32.1178-2)	×	BETAflam®	×	6,0	10	30		
MC-K2,5BY/PV-PLS-BII/-/...	32.1179-1)	×	Byson		2,5	14	22		
MC-K2,5BY/PV-PLS-SII/-/...	32.1180-1)		Byson	×	2,5	14	22		
MC-K2,5BY/PV-PLS-BII/PV-PLS-SII/...	32.1181-2)	×	Byson	×	2,5	14	22		
MC-K4BY/PV-PLS-BIII/-/...	32.1182-1)	×	Byson		4,0	12	30		
MC-K4BY/PV-PLS-SIII/-/...	32.1183-1)		Byson	×	4,0	12	30		
MC-K4BY/PV-PLS-BIII/PV-PLS-SIII/...	32.1184-2)	×	Byson	×	4,0	12	30		
MC-K6BY/PV-PLS-BIII/-/...	32.1185-1)	×	Byson		6,0	10	30		
MC-K6BY/PV-PLS-SIII/-/...	32.1186-1)		Byson	×	6,0	10	30		
MC-K6BY/PV-PLS-BIII/PV-PLS-SIII/...	32.1187-2)	×	Byson	×	6,0	10	30		

1) Bitte Kabellänge in cm angeben; Kabellängen auf Anfrage.

2) Bitte Kabellänge in cm angeben; Mindestlänge 26cm, Maximallänge 200cm.

\* Bitte den Farbcode angeben

1) Please indicate cable length in cm; cable lengths on request.

2) Minimum length 26cm, maximum length 200cm.

\* Add the desired colour code

## Aufbaudosenbuchse, -stecker MC3

## Female and male panel receptacle MC3

PV-ADBP3...

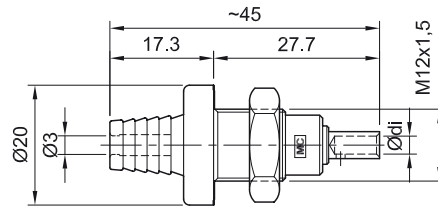

PV-ADSP3...

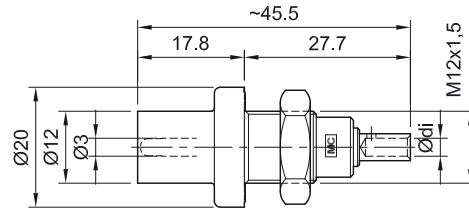

### Technische Daten

Steckverbindersystem	Connector system	Ø 3mm
Bemessungsspannung	Rated voltage	1000V DC (IEC)
Bemessungsstrom	Rated current	20A (2,5mm <sup>2</sup> , 4mm <sup>2</sup> ) 30A (6mm <sup>2</sup> )
Prüfspannung	Test voltage	6kV (50Hz, 1min.)
Umgebungstemperaturbereich	Ambient temperature range	-40°C...+85°C (IEC)
Obere Grenztemperatur	Upper limiting temperature	105°C (IEC)
Schutzart, gesteckt ungesteckt	Degree of protection, mated unmated	IP65 IP2X
Überspannungskat./Verschmutzungsgrad	Overvoltage category/Pollution degree	CATIII/3
Kontaktwiderstand der Steckverbinder	Contact resistance of plug connectors	≤ 0,5mΩ
Schutzklasse	Safety class	II
Kontaktsystem	Contact system	MC Kontaktlamellen MC Multilam
Anschlussart	Type of termination	Crimpen Crimping
Kontaktmaterial	Contact material	Kupfer, verzinkt Copper, tin plated
Isolationsmaterial	Insulation material	PA
Steckkraft/Auszugskraft	Insertion force/Withdrawal force	≤ 50N/≥ 50N
Flammklasse	Flame class	UL94-HB/UL94-V0
TÜV-Zertifiziert	TÜV certified	R60017160



**Verschlusskappen** Seite 54  
**Spezial Steckschlüssel-Einsatz** Seite 60



**Sealing caps** page 54  
**Special socket wrench insert** page 60



Montageanleitung **MA223**  
[www.multi-contact.com](http://www.multi-contact.com)



Assembly Instructions **MA223**  
[www.multi-contact.com](http://www.multi-contact.com)

- MC3 Aufbaudosensteckverbinder bilden die Schnittstelle zwischen einem Wechselrichter bzw. Verteilergehäuse und einem String
- Montage direkt über das Gewinde oder in der Lochplatte mit Gegenmutter (im Lieferumfang enthalten)
- Schnelles und sauberes Stecken
- Die Schutzart IP65 garantiert höchste Anschlusssicherheit
- Steckkompatibel mit MC3
- MC3 panel-receptacle connectors are the interface between an inverter or junction box or junction and a branch cable
- Mounting directly by means of screw thread or in perforated plate with locknut (included in delivery)
- Rapid, precise plugging
- Protection class IP65 guarantees the highest connection safety
- Mating compatibility with MC3

Typ Type	Bestell-Nr. Order No.	Kupplungsbuchse Female cable coupler	Kupplungsstecker Male cable coupler	Leitungsanschluss Cable connection	Leiterschnitt Conductor cross section	Zulassungen Approvals
				Ø di (mm)	mm <sup>2</sup>	
PV-ADBP3/GWD	32.0052	x		3	2,5; 4	
PV-ADSP3/GWD	32.0053		x	3	2,5; 4	
PV-ADBP3/6/GWD	32.0048	x		4	6	
PV-ADSP3/6/GWD	32.0049		x	4	6	

**Hinweis**

In Sonderausführung auch konfektioniert mit Leitung lieferbar. Leitungslängen und Kabelendausführung auf Anfrage, s. Seite 68

**Note:**

Custom made special versions with cable are also available. Lengths and choice of cable ends on request, see page 68

**Aufbaudosenbuchse, -stecker MC4** **Female and male panel receptacle MC4**

**Aufbaudosenbuchsen und -stecker als Einzelteil** (inklusive Isolierteil)

**Female and male panel receptacles as individual part** (including insulating part)

PV-ADBP4-S2...



PV-ADSP4-S2...

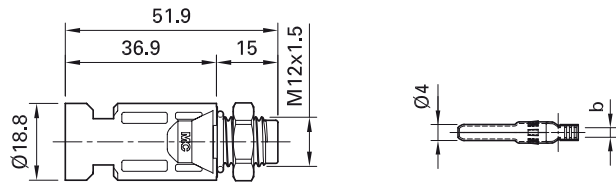
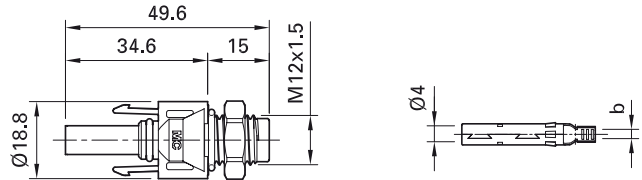

**Technische Daten**

**Technical data**

Steckverbindersystem	Connector system	<b>Ø 4mm</b>
Bemessungsspannung	Rated voltage	<b>1000V DC (IEC)</b>
Bemessungsstrom IEC (90°C)	Rated current IEC (90°C)	<b>17A (1,5mm<sup>2</sup>) 22,5A (2,5mm<sup>2</sup>; 14AWG) 30A (4mm<sup>2</sup>, 6mm<sup>2</sup>; 10AWG) 43A (10mm<sup>2</sup>)</b>
Bemessungsstrom IEC (85°C)	Rated current IEC (85°C)	<b>39A (4mm<sup>2</sup>; 10AWG) 45A (6mm<sup>2</sup>; 10AWG)</b>
Prüfspannung	Test voltage	<b>6kV (50Hz, 1min.)</b>
Umgebungstemperaturbereich	Ambient temperature range	<b>-40°C...+90°C (IEC)</b>
Obere Grenztemperatur	Upper limiting temperature	<b>105°C (IEC)</b>
Schutzart, gesteckt ungesteckt	Degree of protection, mated unmated	<b>IP67 IP2X</b>
Überspannungskat./Verschmutzungsgrad	Overvoltage category/Pollution degree	<b>CATIII/3</b>
Kontaktwiderstand der Steckverbinder	Contact resistance of plug connectors	<b>0,35mΩ</b>
Schutzklasse	Safety class	<b>II</b>
Kontaktsystem	Contact system	<b>MC Kontaktlamellen MC Multilam</b>
Anschlussart	Type of termination	<b>Crimpen Crimping</b>
Kontaktmaterial	Contact material	<b>Kupfer, verzinkt Copper, tin plated</b>
Isolationsmaterial	Insulation material	<b>PC/PA</b>
Verriegelungssystem	Locking system	<b>Snap-in</b>
Flammklasse	Flame class	<b>UL94-V0</b>
TÜV-Zertifiziert	TÜV certified	<b>R60028286</b>

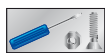

**Sicherungshülse** Seite 53  
**Verschlusskappen** Seite 55  
**Spezial Steckschlüssel-Einsatz** Seite 60  
**Entriegelungsschlüssel** Seite 61

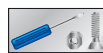

**Safety locking clip** page 53  
**Sealing caps** page 55  
**Special socket wrench insert** page 60  
**Unlocking tool** page 61



Montageanleitung **MA232**  
[www.multi-contact.com](http://www.multi-contact.com)



Assembly Instructions **MA232**  
[www.multi-contact.com](http://www.multi-contact.com)

- MC4 Aufbaudosensteckverbinder bilden die Schnittstelle zwischen einem Wechselrichter bzw. Verteilergehäuse und einem String
- Montage direkt über das Gewinde oder in der Lochplatte mit Gegenmutter (im Lieferumfang enthalten)
- Schnelles und sauberes Stecken
- Die Schutzart IP67 garantiert höchste Anschlusssicherheit
- Steckkompatibel mit MC4
- MC4 panel-receptacle connectors are the interface between an inverter or junction box or junction and a branch cable
- Mounting directly by means of screw thread or in perforated plate with locknut (included in delivery)
- Rapid, precise plugging
- Protection class IP67 guarantees the highest connection safety
- Mating compatibility with MC4



Typ Type	Bestell-Nr. Order No.	Kupplungsbuchse Female cable coupler	Kupplungsstecker Male cable coupler	Leiterquerschnitt Conductor cross section		b (mm)	Zulassungen Approvals
				mm <sup>2</sup>	AWG		
PV-ADBP4-S2/2,5	32.0076P0001	x		1,5; 2,5	14	3	
PV-ADSP4-S2/2,5	32.0077P0001		x	1,5; 2,5	14	3	
PV-ADBP4-S2/6	32.0078P0001	x		4; 6	10	5	
PV-ADSP4-S2/6	32.0079P0001		x	4; 6	10	5	

**Hinweis**

In Sonderausführung auch konfektioniert mit Leitung lieferbar. Leitungslängen und Kabelendausführung auf Anfrage, s. Seite 68

**Note:**

Custom made special versions with cable are also available. Lengths and choice of cable ends on request, see page 68

## Aufbaudosenbuchse, -stecker MC4

### Kontakte auf Trägerband (inklusive Isolierteil)

PV-ADBP4-S2...  
PV-ADSP4-S2...

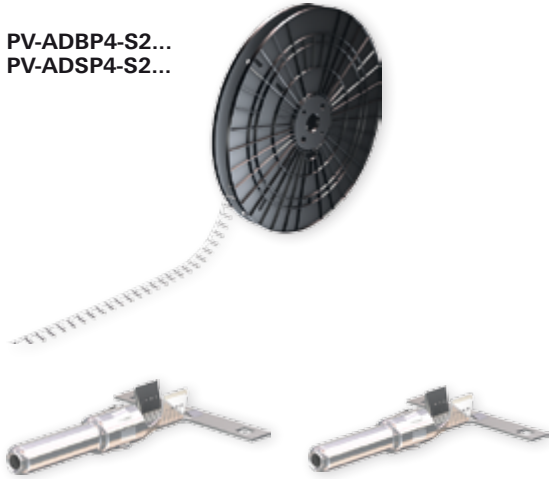

## Female and male panel receptacle MC4

### Contacts on carrier band (including insulating part)

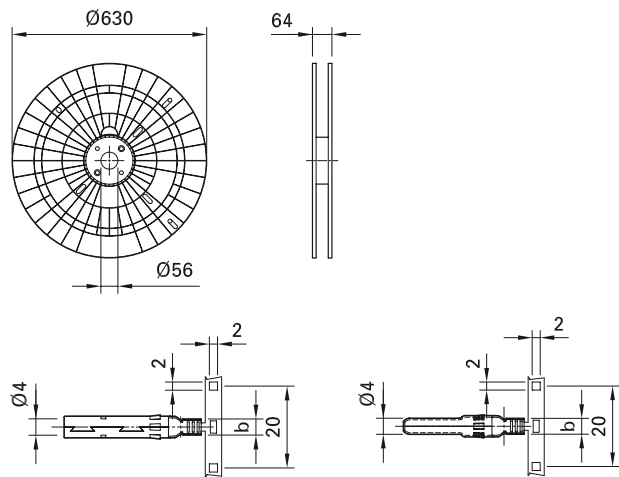

### Technische Daten

Steckverbindersystem  
Bemessungsspannung

Bemessungsstrom IEC (90°C)

Bemessungsstrom IEC (85°C)

Prüfspannung

Umgebungstemperaturbereich

Obere Grenztemperatur

Schutzart, gesteckt  
ungesteckt

Überspannungskat./Verschmutzungsgrad

Kontaktwiderstand der Steckverbinder

Schutzklasse

Kontaktsystem

Anschlussart

Kontaktmaterial

Isolationsmaterial

Verriegelungssystem

Flammklasse

TÜV-Zertifiziert

### Technical data

Connector system

Rated voltage

Rated current IEC (90°C)

Rated current IEC (85°C)

Test voltage

Ambient temperature range

Upper limiting temperature

Degree of protection, mated  
unmated

Overvoltage category/Pollution degree

Contact resistance of plug connectors

Safety class

Contact system

Type of termination

Contact material

Insulation material

Locking system

Flame class

TÜV certified

Ø 4mm

1000V DC (IEC)

17A (1,5mm<sup>2</sup>)

22,5A (2,5mm<sup>2</sup>; 14AWG)

30A (4mm<sup>2</sup>, 6mm<sup>2</sup>; 10AWG)

43A (10mm<sup>2</sup>)

39A (4mm<sup>2</sup>; 10AWG)

45A (6mm<sup>2</sup>; 10AWG)

6kV (50Hz, 1min.)

-40°C...+90°C (IEC)

105°C (IEC)

IP67

IP2X

CATIII/3

0,35mΩ

II

MC Kontaktlamellen

MC Multilam

Crimpen

Crimping

Kupfer, verzinkt

Copper, tin plated

PC/PA

Snap-in

UL94-V0

R60028286

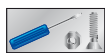

**Sicherungshülse** Seite 53

**Verschlusskappen** Seite 55

**Spezial Steckschlüssel-Einsatz** Seite 60

**Entriegelungsschlüssel** Seite 61

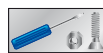

**Safety locking clip** page 53

**Sealing caps** page 55

**Special socket wrench insert** page 60

**Unlocking tool** page 61



Montageanleitung **MA232**

[www.multi-contact.com](http://www.multi-contact.com)





Assembly Instructions **MA232**

[www.multi-contact.com](http://www.multi-contact.com)

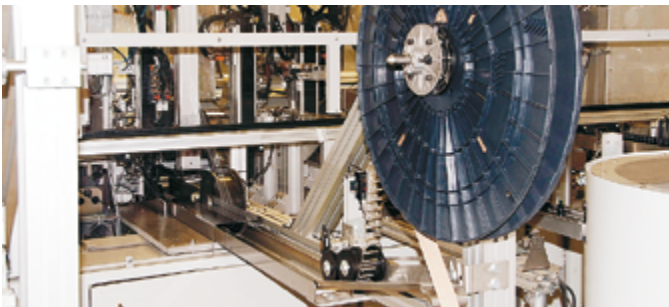

- Trägerbänder zur voll automatischen Konfektionierung
- Speziell für MC4 ausgelegte Werkzeugeinsätze für automatisierte Crimpung erhältlich
- Prozesssicherheit durch speziell entwickeltes Rollendepot
- Feeder bands for fully automatic assembly
- Tools specially designed for MC4 available for automatic crimping
- Process reliability as result of specially developed supply reel



Typ Type	Bestell-Nr. Order No.	Kupplungsbuchse Female cable coupler	Kupplungsstecker Male cable coupler	Leiterquerschnitt Conductor cross section			Crimpwerkzeug Crimping tool	Kontakte pro Rolle <sup>2)</sup> Contacts per Reel <sup>2)</sup>	Zulassungen Approvals
				mm <sup>2</sup>	AWG	b (mm)			
PV-ADBP4-S2/2,5	32.0076P2000	x		1,5; 2,5	14	3	1)	2000	
PV-ADSP4-S2/2,5	32.0077P2000		x	1,5; 2,5	14	3	1)	2000	
PV-ADBP4-S2/6	32.0078P2000	x		4; 6	10	5	1)	2000	
PV-ADSP4-S2/6	32.0079P2000		x	4; 6	10	5	1)	2000	

<sup>1)</sup> Informationen zu halbautomatischem Crimpgerät oder Montagegerät auf Anfrage

<sup>2)</sup> Rollentyp vorbehalten

<sup>1)</sup> Information about a semi-automatic crimp device or assembly device on request

<sup>2)</sup> Reel type subject to alterations

## Abzweighbuchse, -stecker MC3

PV-AZB3-UR



PV-AZS3-UR



## Branch socket, branch plug MC3

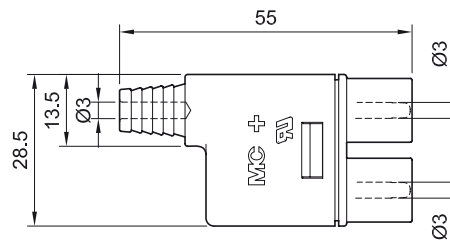
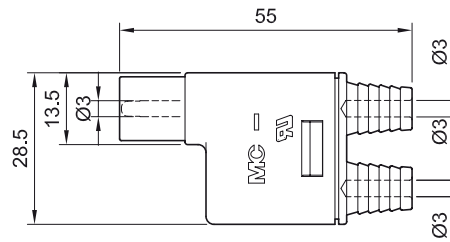

### Technische Daten

Steckverbindersystem	Connector system	<b>Ø 3mm</b>
Bemessungsspannung	Rated voltage	<b>1000V DC (MC) 600V DC (UL)</b>
Bemessungsstrom	Rated current	<b>30A</b>
Prüfspannung	Test voltage	<b>6kV (50Hz, 1min.)</b>
Umgebungstemperaturbereich	Ambient temperature range	<b>-40°C...+90°C (MC) -40°C...+40°C (UL)</b>
Obere Grenztemperatur	Upper limiting temperature	<b>105°C (MC)</b>
Schutzart, gesteckt ungesteckt	Degree of protection, mated unmated	<b>IP65 IP2X</b>
Überspannungskat./Verschmutzungsgrad	Overvoltage category/Pollution degree	<b>CATIII/2</b>
Kontaktwiderstand der Steckverbinder	Contact resistance of plug connectors	<b>≤ 0,5mΩ</b>
Schutzklasse	Safety class	<b>II</b>
Kontaktsystem	Contact system	<b>MC Kontaktlamellen MC Multilam</b>
Kontaktmaterial	Contact material	<b>Kupfer, verzinnt Copper, tin plated</b>
Isolationsmaterial	Insulation material	<b>PA</b>
Steckkraft/Auszugskraft	Insertion force/Withdrawal force	<b>≤ 50N/≥ 50N</b>
Flammklasse	Flame class	<b>UL94-V0</b>
UL-Zulassung	UL-Recognized	<b>E343181</b>
CSA-Zertifiziert	CSA certified	<b>250725</b>

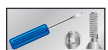

Verschlusskappen Seite 54

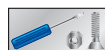



Sealing caps page 54

Für eine sichere und montagefreundliche parallel- oder parallelseriell-Verkabelung von PV-Modulen.  
Steckbar mit einpoligen MC PV-Steckverbindern MC3. Nicht gesteckte Anschlüsse müssen mit einer Verschlusskappe geschützt werden.

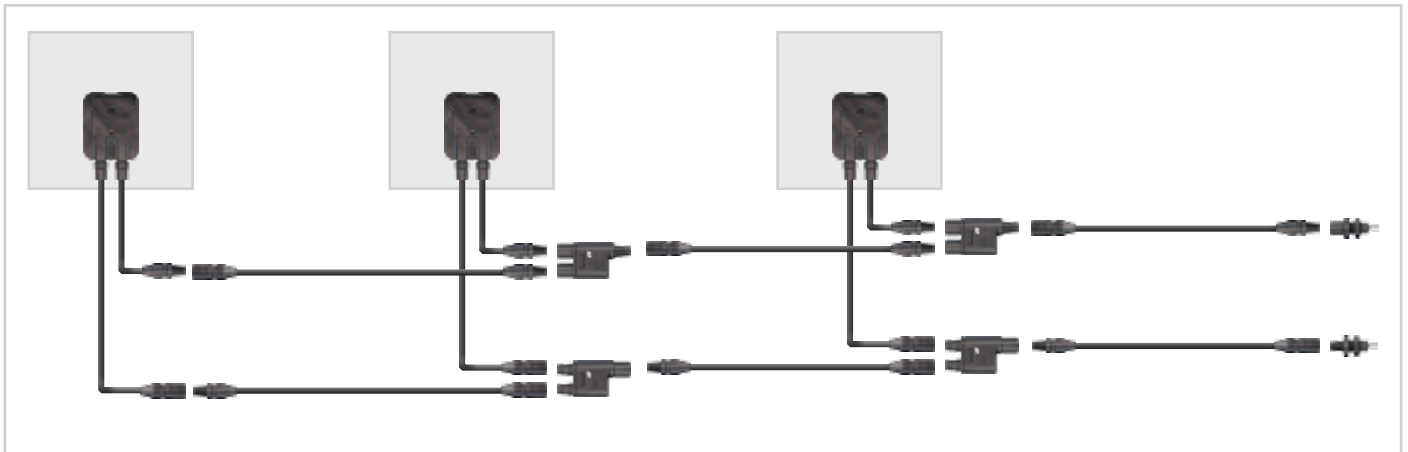
For a safe and simple parallel or serial-parallel connection of PV-modules.  
Pluggable with single-pole MC PV-cable coupler MC3. Unmated connections must be protected by sealing caps.



Typ Type	Bestell-Nr. Order No.	Beschreibung Description	Zulassungen Approvals
<b>PV-AZB3-UR</b>	<b>32.0008-UR</b>	Abzweighbuchse/Branch socket	}  
<b>PV-AZS3-UR</b>	<b>32.0009-UR</b>	Abzweigstecker/Branch plug	

## Abzweigbuchse, -stecker MC4



## Branch socket, branch plug MC4

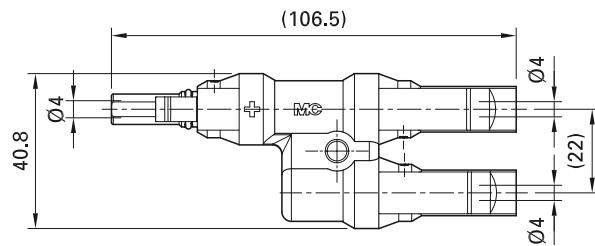
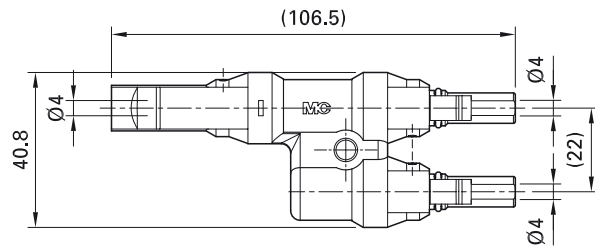

### Technische Daten

Steckverbindersystem
Bemessungsspannung
Bemessungsstrom
Prüfspannung
Umgebungstemperaturbereich
Obere Grenztemperatur
Schutzart, gesteckt ungesteckt
Überspannungskat./Verschmutzungsgrad
Kontaktwiderstand der Steckverbinder
Schutzklasse
Kontaktsystem
Kontaktmaterial
Isolationsmaterial
Verriegelungssystem
Flammklasse

### Technical data

Connector system	<b>Ø 4mm</b>
Rated voltage	<b>1000V DC (MC)</b>
Rated current	<b>30A</b>
Test voltage	<b>6kV (50Hz, 1min.)</b>
Ambient temperature range	<b>-40°C...+90°C (MC)</b>
Upper limiting temperature	<b>105°C (MC)</b>
Degree of protection, mated unmated	<b>IP67 IP2X</b>
Overvoltage category/Pollution degree	<b>CATIII/2</b>
Contact resistance of plug connectors	<b>≤ 0,5mΩ</b>
Safety class	<b>II</b>
Contact system	<b>MC Kontaktlamellen MC Multilam</b>
Contact material	<b>Kupfer, verzinkt Copper, tin plated</b>
Insulation material	<b>PC</b>
Locking system	<b>Snap-in</b>
Flame class	<b>UL94-V0</b>

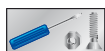

**Sicherungshülse** Seite 53  
**Verschlusskappen** Seite 55  
**Entriegelungsschlüssel** Seite 61

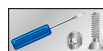

**Safety locking clip** page 53  
**Sealing caps** page 55  
**Unlocking tool** page 61

Für eine sichere und montagefreundliche parallel- oder parallelseriell-Verkabelung von PV-Modulen.

Steckbar mit einpoligen MC PV-Steckverbindern MC4. Nicht gesteckte Anschlüsse müssen mit einer Verschlusskappe geschützt werden.

For a safe and simple parallel or serial-parallel connection of PV-modules.

Pluggable with single-pole MC PV-cable coupler MC4. Unmated connections must be protected by sealing caps.

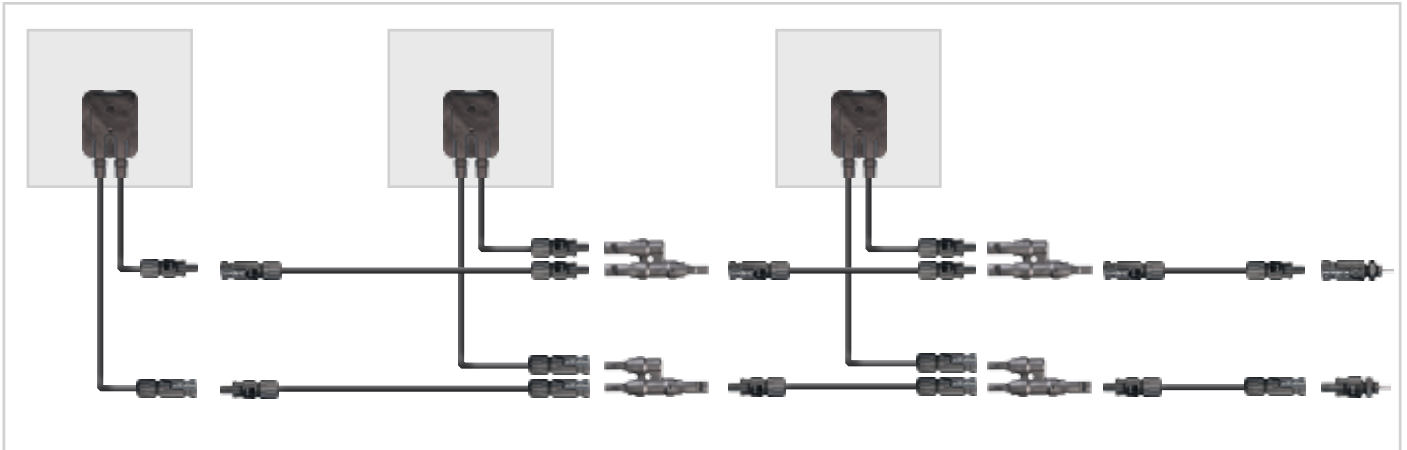

Typ Type	Bestell-Nr. Order No.	Beschreibung Description
<b>PV-AZB4</b>	<b>32.0018</b>	Abzweigbuchse/Branch socket
<b>PV-AZS4</b>	<b>32.0019</b>	Abzweigstecker/Branch plug

**Vorteile der MC Anschlussdosen**

**Advantages of the MC junction boxes**

**Bewährte, langzeitstabile MC Lamellentechnologie im Steckverbinder**  
**Plug connector incorporates tried and tested MC Multilam technology with long-term stability**

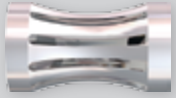

**Geschützt**  
**Protected**

**IEC 60068-2-52**



**UV** **IP67**

**Ammonia**

**Schutzklasse II/Safety class II**



**Montagemöglichkeiten**  
**Mounting possibilities**



**Silikon**  
**Silicone**

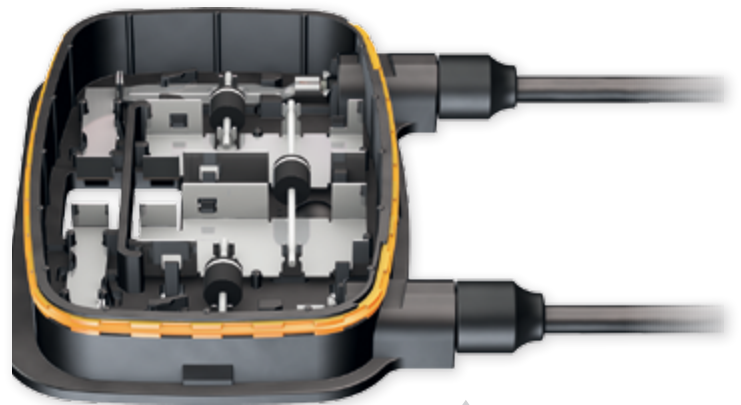

**Vergussmasse**  
**Potting compound**

**Kundenspezifisch konfektionierbar**  
**Suitable for customer-specific assembly**

- Steckverbindersystem/Connector system
- Diode/Diode
- Kabellänge/Cable length

# 3

## Kontaktierungsmöglichkeiten Connection alternatives

- Schweißen/Welding
- Löten/Soldering
- Klemmen/Clamping

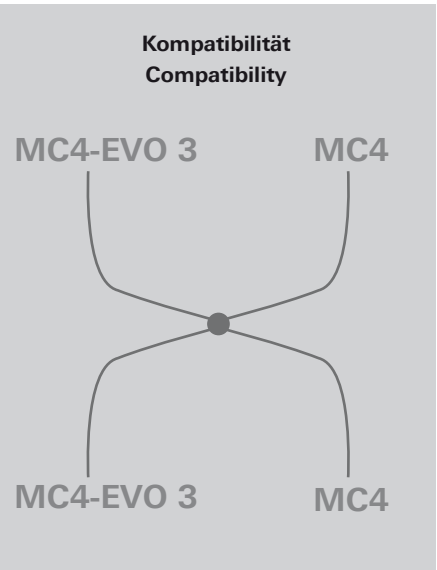
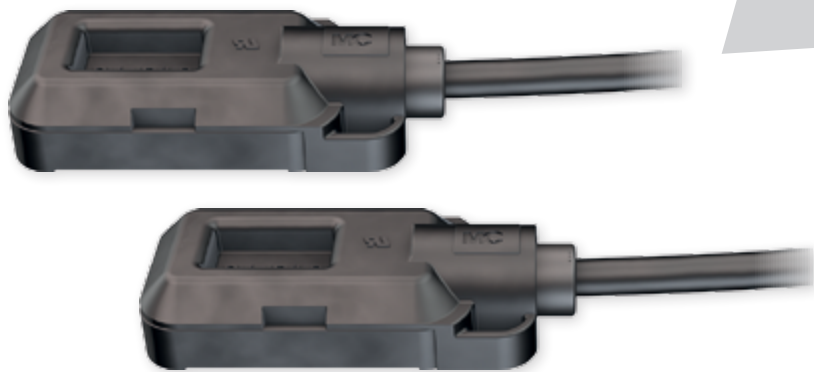

### Montage/Assembly

Automatisierte Montage möglich  
Suitable for automated assembly





















**Übersicht Anschlussdosen** **Overview junction boxes**

	Steckverbindersystem Connector System	Zulassungen <sup>1)</sup> Approvals <sup>1)</sup>

**Für kristalline Module/For crystalline modules**

<b>PV-JB/WL-H Westlake</b>		MC3				
<b>PV-JB/WL-V Westlake</b>		MC4				
		MC4-EVO 3				



**Für Dünnschicht Module/For thin-film modules**

<b>PV-JB/SM SolMac</b>		MC4					
<b>PV-JB-LC</b>		MC3					
<b>PV-JB-LC/SP</b>		MC3					
<b>PV-JB/LP</b>		MC4					













<sup>1)</sup> Zulassungen sind teilweise auf bestimmte Typen begrenzt oder in Bearbeitung. Details auf den jeweiligen Produktseiten.  
<sup>2)</sup> Bestückung mit alternativer Bypassdiode, auf Anfrage  
<sup>3)</sup> Die Eignung der Anschlussdose für eine Bemessungsspannung von 1500V DC ist erfolgreich geprüft. Ein Zertifikat kann erst erstellt werden, sobald es ein für diese Bemessungsspannung zertifiziertes PV Kabel gibt.

<sup>1)</sup> Certifications are in some cases limited to specific types or still pending. Details are given on the relevant product pages  
<sup>2)</sup> Available equipped with alternative bypass diode, on inquiry  
<sup>3)</sup> The suitability of the junction box for a rated voltage of 1500V DC has been successfully tested. A certificate can be issued as soon as a cable certified for this rated voltage is available.

**Zeichenerklärung/Legend**

-  Montage mit Klebepad  
Mounting with adhesive pad
-  Montage mit Silikon  
Mounting with silicone
-  Montage mit Vergussmasse  
Mounting with potting compound



Eigenschaften Features	Salznebelprüftest Salt mist spray test	Bemessungsstrom Rated current	Bemessungsspannung Rated voltage		max.	Flachbandleiter Bus ribbons	Anzahl Dioden Number of diodes	Schutzart, gesteckt Degree of protection, mated	Umgebungstemperatur Ambient temperature range	Pole Poles	Seite Page
			TÜV (V DC)	UL (V DC)							
 	V	10 12 <sup>2)</sup>	1500 <sup>3)</sup>	600 1000	4	Schweißen Löten Klemmen Welding Soldering Clamping	3	IP65	-40...+85	2	<b>34</b> <b>36</b>
  	–	10	1000	600	2	Löten Soldering	1	IP67 IP2X	-40...+90 -40...+40 (UL)	2	<b>38</b>
   	–	10	1000	600	2	Löten Soldering	1/0	IP65 IP2X	-40...+90	2	<b>40</b>
	–	10	1000	600	1	Löten Soldering	0	IP67	-40...+90	1	<b>42</b>
  	–	30	1000	600	1	Schweißen Löten Welding Soldering	0	IP65 IP67	-40...+85	1	<b>44</b>



Kundenspezifisch konfektionierbar  
Suitable for customer-specific assembly



Automatisierte Montage möglich  
Suitable for automated assembly

## PV-Anschlussdose PV-JB/WL-H

## PV junction box PV-JB/WL-H

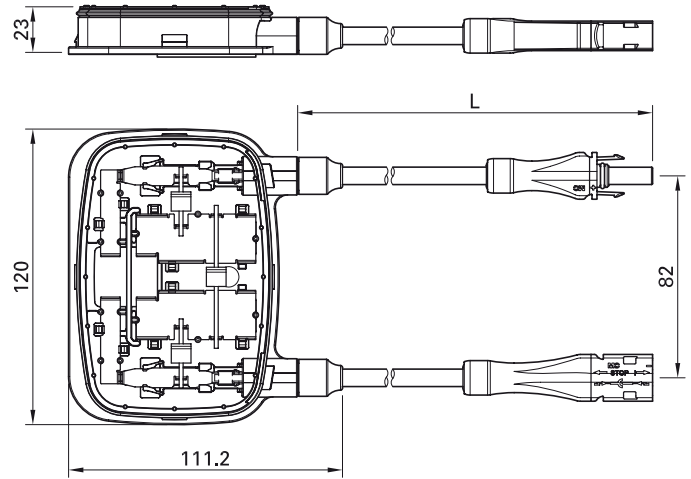
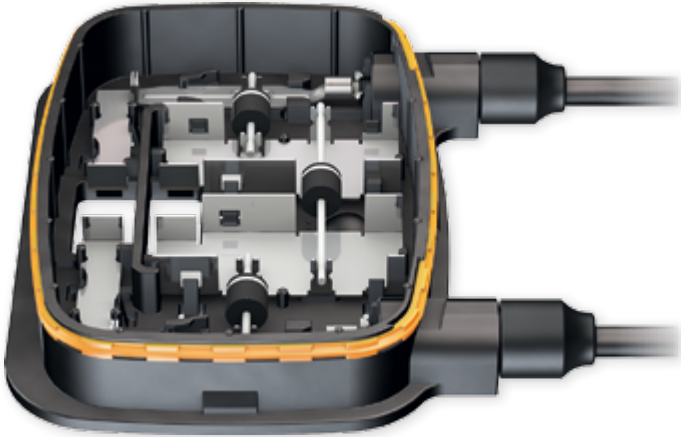

## Technische Daten

Steckverbindersystem	Connector system	<b>MC4-EVO 3<sup>1)</sup></b>
Bemessungsstrom	Rated current	<b>10A</b> (Vishay VSB2045) <sup>1)</sup>
Bemessungsspannung	Rated voltage	<b>1500V DC (IEC)<sup>2)</sup></b> <b>600V/1000V DC (UL)<sup>3)</sup></b>
Umgebungstemperaturbereich	Ambient temperature range	<b>-40°C...+85°C</b>
Schutzart, gesteckt ungesteckt	Degree of protection, mated unmated	<b>IP65</b> <b>IP2X</b>
Kontaktwiderstand der Steckverbinder	Contact resistance of plug connectors	<b>0,35mΩ (MC4, MC4-EVO 3)/ ≤ 0,5mΩ (MC3)</b>
Kontaktmaterial	Contact material	<b>Kupfer, verzinkt/Copper, tin plated</b>
Isolationsmaterial	Insulation material	<b>PPE</b>
Verriegelungssystem Steckverbinder	Locking system plug connectors	<b>Snap-in</b>
Flammklasse	Flame class	<b>UL94-V0</b>
Ammoniakbeständigkeit (gemäss DLG)	Ammonia resistance (acc. to DLG)	<b>1500h, 70°C/70% RH, 750ppm</b>
Salznebelprühtest, Schärfegrad 5	Salt mist spray test, degree of severity 5	<b>IEC 60068-2-52</b>
TÜV-Zertifiziert UL-Zulassung	TÜV certified UL-Recognized	<b>R60040598</b> <b>E335016</b>
Geeignet für Modultyp	Intended for Module type	<b>Kristallin/Crystalline</b>
Pole	Poles	<b>2</b>
Dioden	Diodes	<b>3</b>
Anzahl Flachbandleiter	Number of bus ribbons	<b>4</b>
Ausrichtung der Flachbandleiter	Orientation of bus ribbons	<b>Horizontal/Horizontal</b>
Anschluss der Flachbandleiter	Connection of the bus ribbons	<b>Schweißen/Löten/Klemmen</b> <b>Welding/Soldering/Clamping</b>
Installation	Installation	<b>Silikon/Silicone</b>
Geeignet für automatische Montage	Suitable for automated assembly	<b>Nein/No</b>

<sup>1)</sup> Andere Varianten auf Anfrage, siehe Seite 69

<sup>2)</sup> Die Eignung der Anschlussdose für eine Bemessungsspannung von 1500V DC ist erfolgreich geprüft. Ein Zertifikat kann erst erstellt werden, sobald es ein für diese Bemessungsspannung zertifiziertes PV Kabel gibt.

<sup>3)</sup> Abhängig vom Leitungstyp

<sup>1)</sup> Other versions on request, see page 69

<sup>2)</sup> The suitability of the junction box for a rated voltage of 1500V DC has been successfully tested. A certificate can be issued as soon as a cable certified for this rated voltage is available.

<sup>3)</sup> Depending on type of wire



**Verschlusskappen** Seite 55  
**Entriegelungsschlüssel** Seite 61

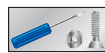

**Sealing caps** page 55  
**Unlocking tool** page 61









Montageanleitung **MA269**  
[www.multi-contact.com](http://www.multi-contact.com)



Assembly Instructions **MA269**  
[www.multi-contact.com](http://www.multi-contact.com)

- **Anschlussdose für kristalline Module zur elektrischen Kontaktierung horizontal verlegter Anschlussbändchen**
- Die flache Bauform ermöglicht eine Installation der Dose direkt unter der Modulrahmenkonstruktion. Hierdurch wird im Installationsprozess wertvolle Zeit eingespart, denn ein Abwinkeln der Flachbandleiter entfällt. Der Anschluss erfolgt durch Schweißen, Lötten oder optional durch Klemmen.
- Die Dose wird mit Silikon auf dem Panel befestigt. Zusätzlichen Schutz der Kabeltüllen bietet die überstehende Deckelkonstruktion, die ein Abknicken der Kabel am Tüllenausgang verhindert.
- Verriegelung der Steckverbinder nach NEC 2011 durch Snap-in-Verschluss für höchste Anschlusssicherheit, nur mit Werkzeug PV-MS-PLS entriegelbar.
- Steckkompatibel mit MC4
- Sonderanfertigungen auf Anfrage (s. Seite 69):
  - Individuelle Leitungslängen
  - Bestückung mit MC3 und MC4 Steckverbindern
  - Leitungsfarben rot oder blau (nur TÜV-Variante)
  - Fertigung mit alternativer Bypassdiode vom Typ Diotec SBX3040 12A auf Anfrage möglich

- **Junction box for electrical connection of horizontal ribbon conductors on crystalline modules**
- The low profile construction of the box allows it to be installed directly under the module frame. This saves valuable time in the installation process by eliminating the need to bend the connecting ribbons. Ribbon termination is achieved by welding, soldering, or, optionally, by terminal clips.
- The box is fixed to the panel with silicone RTV. Additional protection given by the projecting cover, which prevents kinking of the cables at the point where they emerge from the cable gland.
- Fully NEC 2011 compliant requiring the special tool PV-MS-PLS to disconnect the cable couplers.
- Compatible with MC4
- Custom versions on request (see page 69):
  - Individual lead lengths
  - Equipped with MC3 and MC4 connectors
  - Cable colours red or blue (only TÜV types)
  - Can be produced on request with alternative bypass diode of type Diotec SBX3040 12A.

Typ Type	Bestell-Nr. Order No.	Anschluss der Flachbandleiter Connection of the bus ribbons		Leiterquerschnitt Cable cross section mm <sup>2</sup>	Leitungslänge (L) Length of cable (L) cm	Leitungstyp Cable type	Steckverbinder Plug connectors	Zulassungen Approvals
		WS <sup>4)</sup>	C <sup>4)</sup>					
PV-JB/WL-H-01-C-WS	32.7260-080	x		4	80	FLEX-SOL-XL	MC4-EVO 3	
PV-JB/WL-H-01-C-C	32.7261-080		x	4	80	FLEX-SOL-XL	MC4-EVO 3	
PV-JB/WL-H-01-A-WS	32.7262-080-UR	x		4	80	BETAflam®	MC4-EVO 3	
PV-JB/WL-H-01-A-C	32.7263-080-UR		x	4	80	BETAflam®	MC4-EVO 3	
PV-JB/WL-H-01-B-WS	32.7264-080-UR	x		4	80	Byson	MC4-EVO 3	
PV-JB/WL-H-01-B-C	32.7265-080-UR		x	4	80	Byson	MC4-EVO 3	

<sup>3)</sup> Abhängig vom Leitungstyp

<sup>4)</sup> WS Schweißen/Lötten  
C Klemmen

<sup>3)</sup> Depending on type of wire

<sup>4)</sup> WS Welding/Soldering  
C Clamping

## PV-Anschlussdose PV-JB/WL-V

## PV junction box PV-JB/WL-V

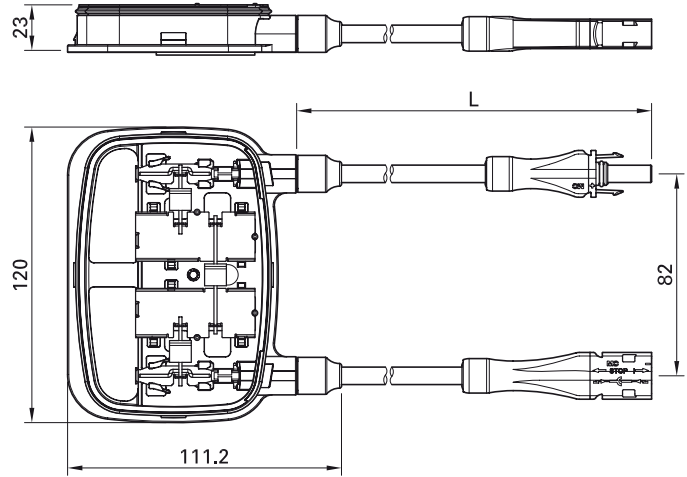
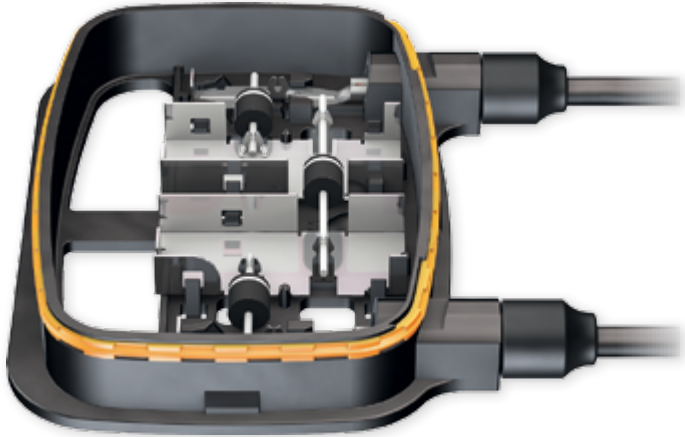

## Technische Daten

Steckverbindersystem	Connector system	<b>MC4-EVO 3<sup>1)</sup></b>
Bemessungsstrom	Rated current	<b>10A</b> (Vishay VSB2045) <sup>1)</sup>
Bemessungsspannung	Rated voltage	<b>1000V DC / 1500V DC (IEC)<sup>2)</sup></b> <b>600V/1000V DC (UL)<sup>2)</sup></b>
Umgebungstemperaturbereich	Ambient temperature range	<b>-40°C...+85°C</b>
Schutzart, gesteckt ungesteckt	Degree of protection, mated unmated	<b>IP65</b> <b>IP2X</b>
Kontaktwiderstand der Steckverbinder	Contact resistance of plug connectors	<b>0,35mΩ</b> (MC4, MC4-EVO 3)/ <b>≤ 0,5mΩ</b> (MC3)
Kontaktmaterial	Contact material	<b>Kupfer, verzinkt/Copper, tin plated</b>
Isolationsmaterial	Insulation material	<b>PPE</b>
Verriegelungssystem Steckverbinder	Locking system plug connectors	<b>Snap-in</b>
Flammklasse	Flame class	<b>UL94-V0</b>
Ammoniakbeständigkeit (gemäss DLG)	Ammonia resistance (acc. to DLG)	<b>1500h, 70°C/70% RH, 750ppm</b>
Salznebelprüfetest, Schärfegrad 5	Salt mist spray test, degree of severity 5	<b>IEC 60068-2-52</b>
TÜV-Zertifiziert	TÜV certified	<b>R60040598</b>
Geeignet für Modultyp	Intended for Module type	<b>Kristallin/Crystalline</b>
Pole	Poles	<b>2</b>
Dioden	Diodes	<b>3</b>
Anzahl Flachbandleiter	Number of bus ribbons	<b>4</b>
Anschluss Flachbandleiter	Connection of bus ribbons	<b>Vertikal/Vertical</b>
Anschluss der Flachbandleiter	Connection of the bus ribbons	<b>Schweissen/Löten/Klemmen</b> <b>Welding/Soldering/Clamping</b>
Installation	Installation	<b>Silikon/Silicone</b>
Geeignet für automatische Montage	Suitable for automated assembly	<b>Nein/No</b>

<sup>1)</sup> Andere Varianten auf Anfrage, siehe Seite 69

<sup>2)</sup> In Bearbeitung

<sup>1)</sup> Other versions on request, see page 69

<sup>2)</sup> In Process



**Verschlusskappen** Seite 55  
**Entriegelungsschlüssel** Seite 61

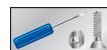





**Sealing caps** page 55  
**Unlocking tool** page 61

### ■ Anschlussdose für kristalline Module zur elektrischen Kontaktierung vertikal verlegter Anschlussbändchen

- Die flache Bauform ermöglicht eine Installation der Dose direkt unter der Modulrahmenkonstruktion. Der Anschluss erfolgt durch Schweißen, Löten oder optional durch Klemmen.
- Die Dose wird mit Silikon auf dem Panel befestigt. Zusätzlichen Schutz der Kabeltüllen bietet die überstehende Deckelkonstruktion, die ein Abknicken der Kabel am Tüllenausgang verhindert.
- Verriegelung der Steckverbinder nach NEC 2011 durch Snap-in-Verschluss für höchste Anschlusssicherheit, nur mit Werkzeug PV-MS-PLS entriegelbar.
- Steckkompatibel mit MC4
- Sonderanfertigungen auf Anfrage (s. Seite 69):
  - Individuelle Leitungslängen
  - Bestückung mit MC3 und MC4 Steckverbindern
  - Leitungsfarben rot oder blau (nur TÜV-Variante)
  - Fertigung mit alternativer Bypassdiode vom Typ Diotec SBX3040 12A auf Anfrage möglich

### ■ Junction box for electrical connection of vertical ribbon conductors on crystalline modules

- The low profile construction of the box allows it to be installed directly under the module frame. Ribbon termination is achieved by welding, soldering, or, optionally, by terminal clips.
- The box is fixed to the panel with silicone. Additional protection given by the projecting cover, which prevents kinking of the cables at the point where they emerge from the cable sleeve.
- Fully NEC 2011 compliant requiring the special tool PV-MS-PLS to disconnect the cable couplers.
- Compatible with MC4
- Custom versions on request (see page 69):
  - Individual lead lengths
  - Equipped with MC3 and MC4 connectors
  - Cable colours red or blue (only TÜV types)
  - Can be produced on request with alternative bypass diode of type Diotec SBX3040 12A.

Typ Type	Bestell-Nr. Order No.	Anschluss der Flachbandleiter Connection of the bus ribbons		Leiterquerschnitt Cable cross section mm <sup>2</sup>	Leitungslänge (L) Length of cable (L) cm	Leitungstyp Cable type	Steckverbinder Plug connectors	Zulassungen Approvals
		WS <sup>3)</sup>	C <sup>3)</sup>					
<b>PV-JB/WL-V-01-C-WS</b>	<b>32.7266-080</b>	x		4	80	FLEX-SOL-XL	MC4-EVO 3	
<b>PV-JB/WL-V-01-C-C</b>	<b>32.7267-080</b>		x					
<b>PV-JB/WL-V-01-A-WS</b>	<b>32.7268-080-UR</b>	x		4	80	BETAflam <sup>®</sup>	MC4-EVO 3	
<b>PV-JB/WL-V-01-A-C</b>	<b>32.7269-080-UR</b>		x					
<b>PV-JB/WL-V-01-B-WS</b>	<b>32.7270-080-UR</b>	x		4	80	Byson	MC4-EVO 3	
<b>PV-JB/WL-V-01-B-C</b>	<b>32.7271-080-UR</b>		x					

<sup>2)</sup> In Bearbeitung

<sup>3)</sup> WS Schweißen/Löten  
C Klemmen

<sup>2)</sup> In Process

<sup>3)</sup> WS Welding/Soldering  
C Clamping

## PV-Anschlussdose PV-JB/SM...

## PV junction box PV-JB/SM...

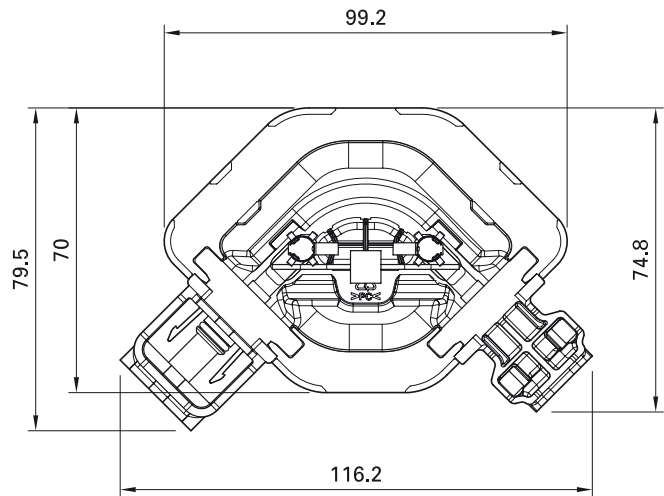

## Technische Daten

Steckverbindersystem	Connector system	<b>MC4/MC4-EVO 3</b>
Bemessungsstrom	Rated current	<b>10A</b>
Bemessungsspannung <sup>1)</sup>	Rated voltage <sup>1)</sup>	<b>1000V (IEC) 600V (UL)</b>
Umgebungstemperaturbereich	Ambient temperature range	<b>-40°C...+90°C (IEC) -40°C...+40°C (UL)<sup>5)</sup></b>
Schutzart <sup>1)</sup> , gesteckt ungesteckt	Degree of protection <sup>1)</sup> , mated unmated	<b>IP67<sup>2)</sup> IP2X<sup>3)</sup></b>
Kontaktwiderstand der Steckverbinder	Contact resistance of plug connectors	<b>≤ 0,5mΩ</b>
Kontaktmaterial	Contact material	<b>Kupferlegierung, verzinkt Copper alloy, tin plated</b>
Isolationsmaterial	Insulation material	<b>PC</b>
Verriegelungssystem Steckverbinder	Locking system plug connectors	<b>Snap-in</b>
Flammklasse	Flame class	<b>UL94-V0</b>
Salznebelprüfetest, Schärfegrad 5	Salt mist spray test, degree of severity 5	<b>IEC 60068-2-52</b>
TÜV-Zertifiziert	TÜV certified	<b>R60021888</b>
UL-Zulassung	UL-Recognized	<b>E181720</b>
CSA-Zertifiziert	CSA certified	<b>250725</b>

Geeignet für Modultyp	Intended for Module type	<b>Dünnschicht Thin film</b>
Pole	Poles	<b>2</b>
Dioden	Diodes	<b>1</b>
Anzahl Flachbandleiter	Number of bus ribbons	<b>2</b>
Anschluss der Flachbandleiter	Connection of the bus ribbons	<b>Schweißen Welding</b>
Installation	Installation	<b>Silikon &amp; Vergussmasse Silicone &amp; potting compound</b>
Geeignet für automatische Montage	Suitable for automated assembly	<b>Ja Yes</b>



**Verschlusskappen** Seite 55  
**Entriegelungsschlüssel** Seite 61



**Sealing caps** page 55  
**Unlocking tool** page 61







Montageanleitung **MA255**  
[www.multi-contact.com](http://www.multi-contact.com)



Assembly Instructions **MA255**  
[www.multi-contact.com](http://www.multi-contact.com)

- Speziell konzipiert für automatisierbare Fertigungsprozesse
- Hohe Prozesssicherheit durch aufeinander abgestimmte Komponenten, Vergussmasse und Kleber
- Speziell entwickelt für Dünnschicht PV Module
- MC4 Anschlussstecker direkt in die Anschlussdose integriert
- Mit integrierter Überlaufwanne zur Aufnahme überschüssiger Vergussmasse während des Montageprozesses
- Einsparung von Verkabelung aufgrund 45°-winkliger Steckgesichter
- Der Sicherheitsdeckel PV-JB/SM-SSC erhöht die bereits allen Normen genügende Witterungsbeständigkeit der PV-JB/SM zusätzlich.
- Ohne Diode auf Anfrage
- Designed specifically for fully automated assembly
- Fast and robust assembly using recommended RTV encapsulant (pottant) and adhesive systems
- Specially designed for thin film PV modules
- MC4 Terminal connector integrated into the junction box
- Unique overflow well to capture excess encapsulant during assembly
- Savings on cabling due to 45° orientation of the mating connectors
- This Secondary safety cover PV-JB/SM-SSC is intended to further improve the already compliant weatherability of the PV-JB/SM.
- Version without diode on request

Typ Type	Bestell Nr. Order No.	Lieferform Delivered	Zulassungen <sup>1)</sup> Approvals <sup>1)</sup>
<b>PV-JB/SM-D(A)</b>	<b>32.7085</b>	komplett mit Diode <sup>4)</sup> /complete with diode <sup>4)</sup>	   

**Einzelteile**

**Individual parts**

PV-JB/SM-ND(A)	32.7916	ohne Deckel, mit Diode /without lid, with diode
PV-DJB/SM	32.7915	Deckel/Lid

**Zubehör**

**Accessories**

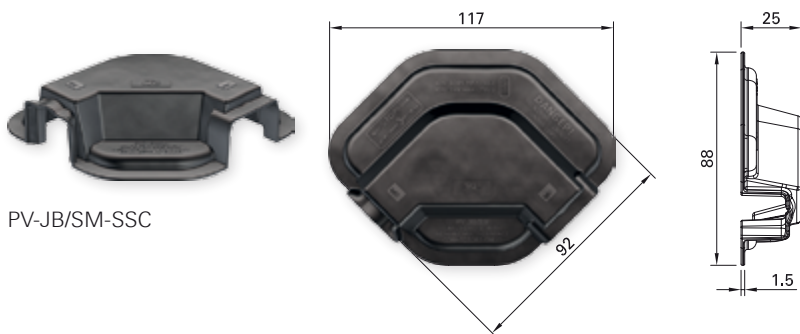

Typ Type	Bestell Nr. Order No.	Bezeichnung Designation	Siehe Montageanleitung See assembly instruction	
PV-JB/SM-SSC	32.7914	Sicherheitsdeckel / Secondary safety cover	MA261	

<sup>1)</sup> Die für das Produkt angegebenen Zertifizierungen, TÜV und UL, gelten für die Systemkomponente unter Verwendung der dafür bestimmten Vergussmasse und Kleber. Die Aufrechterhaltung der Zertifizierung im Endprodukt liegt in der Verantwortung des Kunden und ist unter anderem abhängig von seiner Auswahl und Verwendung von Vergussmasse und Kleber.  
<sup>2)</sup> Gesteckt, Pannedose montiert mit Deckel und Vergussmasse  
<sup>3)</sup> Ungesteckt, Pannedose montiert  
<sup>4)</sup> Alternative Dioden auf Anfrage erhältlich  
<sup>5)</sup> Zertifiziert nach UL 1703. Physisch ist die Anschlussdose auch für eine Temperatur bis +85°C ausgelegt. Neue UL-Zulassung auf Anfrage

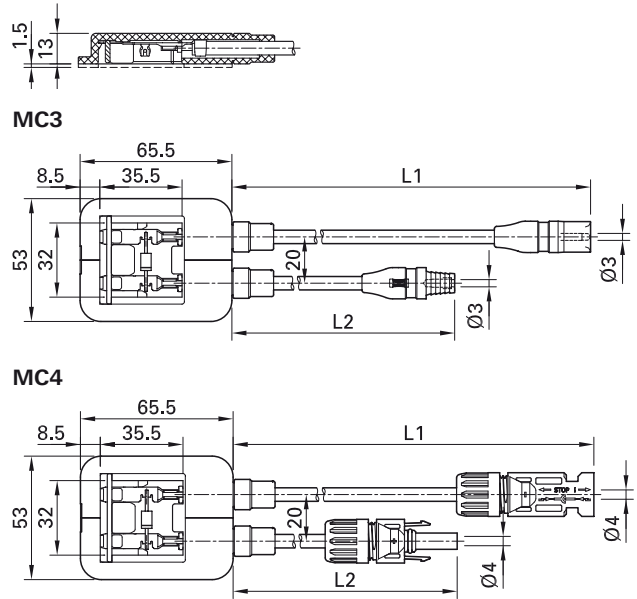
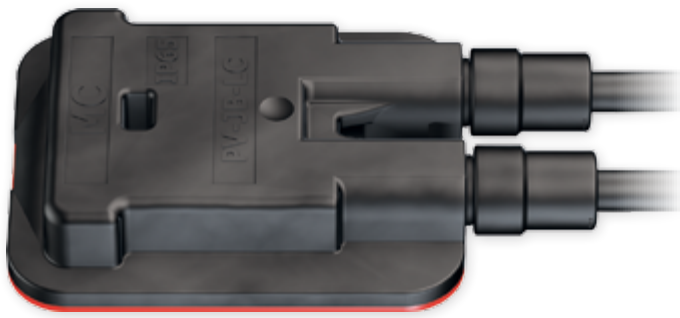

<sup>1)</sup> This product carries the stated certifications, TÜV and UL, as a system component using representative encapsulant (pottant) and adhesive. Maintaining this level of certification in the end product is the responsibility of the customer and is dependent, among other things, upon their selection and use of encapsulant (pottant) and adhesive.  
<sup>2)</sup> Mated, junction box assembled with lid and encapsulant  
<sup>3)</sup> Unplugged/junction box installed  
<sup>4)</sup> Alternate Diodes available upon request  
<sup>5)</sup> Certified according to UL 1703. The junction box is physically designed for a temperature of up to +85°C. New UL certificate on request.

**PV-Anschlussdose PV-JB-LC... PV junction box PV-JB-LC...**

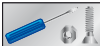

Technische Daten	Technical data	MC3/MC4
Steckverbindersystem	Connector system	<b>MC3/MC4</b>
Bemessungsstrom mit Diode (F1200D), Montage auf Glas mit Diode (F1200D), Montage auf Glas, Tedlar oder PET Folie mit Diode (BY255), Montage auf Glas, Tedlar oder PET Folie	Rated current with diode (F1200D), for mounting on glass with diode (F1200D), for mounting on glass, tedlar or PET film with diode (BY255), for mounting on glass, tedlar or PET film	<b>10,0A 5,0A 2,5A</b>
Bemessungsspannung	Rated voltage	<b>1000V DC (IEC) 600V DC (UL)</b>
Umgebungstemperaturbereich	Ambient temperature range	<b>-40°C...+90°C</b>
Schutzart, gesteckt ungesteckt	Degree of protection, mated unmated	<b>IP65 IP2X</b>
Kontaktwiderstand der Steckverbinder	Contact resistance of plug connectors	<b>0,35mΩ (MC4)/ ≤0,5mΩ (MC3)</b>
Kontaktmaterial	Contact material	<b>Kupfer, verzinkt Copper, tin plated</b>
Isolationsmaterial	Insulation material	<b>PA</b>
Verriegelungssystem Steckverbinder	Locking system plug connectors	<b>Snap-in (nur/only MC4)</b>
Flammklasse	Flame class	<b>UL94-V0</b>
TÜV-Zertifiziert UL-Zulassung CSA-Zertifiziert	TÜV certified UL-Recognized CSA certified	<b>R60024490 E181720 250725</b>
Geeignet für Modultyp	Intended for Module type	<b>Dünnschicht/Thin film</b>
Pole	Poles	<b>2</b>
Dioden	Diodes	<b>1/0</b>
Anzahl Flachbandleiter	Number of bus ribbons	<b>2</b>
Anschluss der Flachbandleiter	Connection of the bus ribbons	<b>Löten Soldering</b>
Installation	Installation	<b>Klebepad oder Silikon Adhesive pad or silicone</b>
Geeignet für automatische Montage	Suitable for automated assembly	<b>Ja/Yes</b>

 **Sicherungshülse MC4** Seite 53  
 **Verschlusskappen** Seite 54, 55  
 **Entriegelungsschlüssel MC4** Seite 61

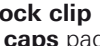
 **Safety lock clip MC4** page 53  
 **Sealing caps** page 54, 55  
 **Unlocking tool MC4** page 61

 **Montageanleitung MA246**  
[www.multi-contact.com](http://www.multi-contact.com)

 **Assembly Instructions MA246**  
[www.multi-contact.com](http://www.multi-contact.com)



- Speziell entwickelt für Dünnschicht PV Module
  - Kein zusätzliches Silikon-Füllmaterial notwendig
  - Einfache, zeitsparende Montage mit Klebepad
  - Klebepad ist werksseitig vormontiert
  - 2 Montage-Varianten:
    - Klebepad
    - Silikon
  - Flache Bauweise
  - Anschlüsse vorbereitet mit aufgebrachtem Lötzinn
  - Serienmässig bestückt mit Bypass-Diode<sup>1)</sup> (BY255; 3A)
  - Sonderanfertigungen auf Anfrage (s. Seite 70):
    - Individuelle Leitungslängen
    - Leitungstyp RADOX
    - Leitungsfarben rot oder blau (nur TÜV-Varianten)
    - Bestückung mit alternativer Bypassdiode
- Specially designed for thin-film PV modules
  - No additional silicone filling material needed
  - Simple and time saving assembly with adhesive pad
  - Adhesive pad is pre-applied at factory
  - 2 fixing alternatives:
    - adhesive pad
    - silicone
  - Flat design
  - Module ribbon connections prepared with pre-applied solder
  - Fitted with bypass diode<sup>1)</sup> (BY255; 3A) as standard
  - Custom versions on request (see page 70):
    - Individual lead lengths
    - Cable type RADOX
    - Cable colours red or blue (only TÜV types)
    - Fitted with alternative bypass diode

Typ Type	Bestell-Nr. Order No.	Montage mit Mounted with		Leiterquerschnitt Cable cross section mm <sup>2</sup>	Leitungstyp Cable type	L1/L2 cm	Steckverbinder Plug connectors	Leitungsfarbe Cable colour	Zulassungen Approvals
		Klebepad Adhesive pad	Silikon Silicone						
PV-JB-LC-2/2,5SXL/KF	32.7211-100100*	×		2,5	FLEX-SOL-XL 2,5	100	MC3		
PV-JB-LC-2/N2,5SXL/KF	32.7223-100100*	×		2,5	FLEX-SOL-XL 2,5	100	MC4		
PV-JB-LC-2/2,5SXL	32.7253-100100*		×	2,5	FLEX-SOL-XL 2,5	100	MC3		
PV-JB-LC-2/N2,5SXL	32.7254-100100*		×	2,5	FLEX-SOL-XL 2,5	100	MC4		
PV-JB-LC-2/2,5BE/KF	32.7224-100100	×		2,5	BETAflam®	100	MC3		
PV-JB-LC-2/N2,5BE/KF	32.7225-100100	×		2,5	BETAflam®	100	MC4		
PV-JB-LC-2/2,5BE	32.7255-100100		×	2,5	BETAflam®	100	MC3		
PV-JB-LC-2/N2,5BE	32.7256-100100		×	2,5	BETAflam®	100	MC4		

**Zubehör**

**Accessories**



PV-WZ-JB/LC



PV-KH/LC



PV-WZ-JB/LC	32.6045	Hilfswerkzeug zur rationellen Montage/Auxiliary tool for efficient installation
PV-KH/LC	32.5294	Kabelhalter zur definierten Steckung bei automatischer oder manueller Prüfung (Flashen) der Module Cable retainer for defined connection in automatic or manual testing (flashing) of the module für/for FLEX-SOL-XL 2,5mm <sup>2</sup>
PV-KH/LC II	32.5408	Kabelhalter zur definierten Steckung bei automatischer oder manueller Prüfung (Flashen) der Module Cable retainer for defined connection in automatic or manual testing (flashing) of the module für/for BETAflam® 2,5mm <sup>2</sup>

\* Bitte den Farbcode angeben

<sup>1)</sup> Anschlussdose ohne Diode sind weder TÜV noch UR zertifiziert.

\* Add the desired colour code

<sup>1)</sup> Junction boxes without diodes have neither TÜV nor UR certification.

## PV-Anschlussdose PV-JB-LC/SP...

## PV junction box PV-JB-LC/SP...

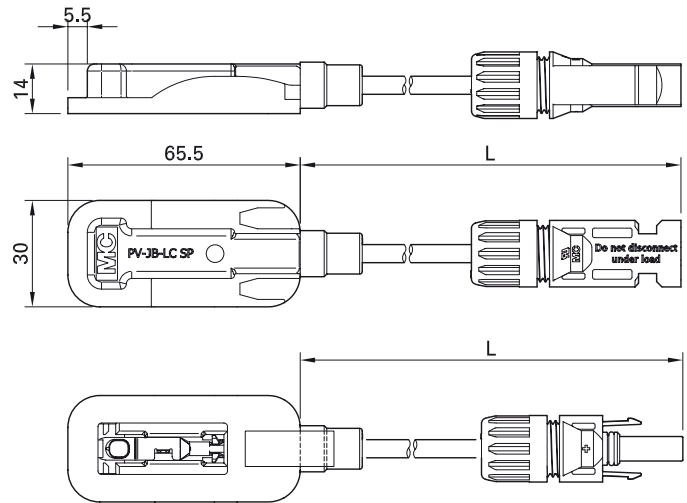

## Technische Daten

Steckverbindersystem	Connector system	<b>MC3/MC4/MC4-EVO 3</b>
Bemessungsstrom	Rated current	<b>10A</b>
Bemessungsspannung	Rated voltage	<b>1000V DC (IEC) 600V DC (UL)<sup>1)</sup></b>
Umgebungstemperaturbereich	Ambient temperature range	<b>-40...+90°C</b>
Schutzart, gesteckt ungesteckt	Degree of protection, mated unmated	<b>IP65 IP2X</b>
Kontaktwiderstand der Steckverbinder	Contact resistance of plug connectors	<b>0,35mΩ (MC4, MC4-EVO 3)/≤0,5mΩ (MC3)</b>
Kontaktmaterial	Contact material	<b>Kuper, verzinkt Copper, tin plated</b>
Isolationsmaterial	Insulation material	<b>PA</b>
Verriegelungssystem Steckverbinder	Locking system plug connectors	<b>Snap-in</b>
Flammklasse	Flame class	<b>UL94-V0</b>
TÜV-Zertifiziert	TÜV certified	<b>R60024490</b>

Geeignet für Modultyp	Intended for Module type	<b>Dünnschicht Thin film</b>
Pole	Poles	<b>1</b>
Dioden	Diodes	<b>-</b>
Anzahl Flachbandleiter	Number of bus ribbons	<b>1</b>
Anschluss der Flachbandleiter	Connection of the bus ribbons	<b>Löten Soldering</b>
Installation	Installation	<b>Klebepad Adhesive pad</b>
Geeignet für automatische Montage	Suitable for automated assembly	<b>Nein No</b>

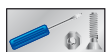

**Sicherungshülse MC4** Seite 53

**Verschlusskappen** Seite 55

**Entriegelungsschlüssel** Seite 61

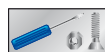

**Safety lock clip MC4** page 53

**Sealing caps** page 55

**Unlocking tool** page 61



Montageanleitung **MA265**

[www.multi-contact.com](http://www.multi-contact.com)



Assembly Instructions **MA265**

[www.multi-contact.com](http://www.multi-contact.com)

- Einpolige, kostengünstige und manuell zu montierende Anschlussdosen basierend auf dem Design der bewährten PV-JB-LC, bestückt mit MC4 Steckverbindern.
  - Optionale Kabelhalterung
  - Sonderanfertigungen auf Anfrage:
    - Individuelle Leitungslängen
    - Bestückung mit MC3 oder MC4-EVO 3 Steckverbindern
  - UL in Bearbeitung
- Single-pole, economically priced junction box for manual mounting based on the design of the tried and tested PV-JB-LC, equipped with MC4 connectors.
  - Optional cable retainer
  - Custom versions on request:
    - Individual lead lengths
    - Equipped with MC3 and MC4-EVO 3 connectors
  - UL in process

Typ Type	Bestell-Nr. Order No.	Beschreibung Description	Leiterquerschnitt Cable cross section	L	Leitungstyp Cable type	Leitungsfarbe <sup>2)</sup> Cable colour <sup>2)</sup>
			mm <sup>2</sup>	cm		
<b>PV-JB-LC/SP/N2,5SXL/KF</b>	<b>32.7232-050*</b>	Anschlussdosen-Set/Junction box set	2,5	50	FLEX-SOL-XL	21
<b>PV-JB-LC/SP/N2,5BE/KF</b>	<b>32.7274-050-UR</b>	Anschlussdosen-Set/Junction box set	2,5	50	BETAflam®	■

**Zubehör**

**Accessories**



PV-WZ-JB/LC/SP



PV-KH/LC

PV-WZ-JB/LC/SP	32.6059	Hilfswerkzeug zur rationellen Montage/Auxiliary tool for efficient installation
PV-KH/LC	32.5294	Kabelhalter zur definierten Steckung bei automatischer oder manueller Prüfung (Flashen) der Module Cable retainer for defined connection in automatic or manual testing (flashing) of the module für/for FLEX-SOL-XL 2,5mm <sup>2</sup>
PV-KH/LC II	32.5408	Kabelhalter zur definierten Steckung bei automatischer oder manueller Prüfung (Flashen) der Module Cable retainer for defined connection in automatic or manual testing (flashing) of the module für/for BETAflam® 2,5mm <sup>2</sup>

\* Bitte den Farbcode angeben

<sup>1)</sup> In Bearbeitung

<sup>2)</sup> Leitungsfarbe rot oder blau auf Anfrage

\* Add the desired colour code

<sup>1)</sup> In process

<sup>2)</sup> Cable colours red or blue on request

## PV-Anschlussdose PV-JB/LP...

## PV junction box PV-JB/LP...

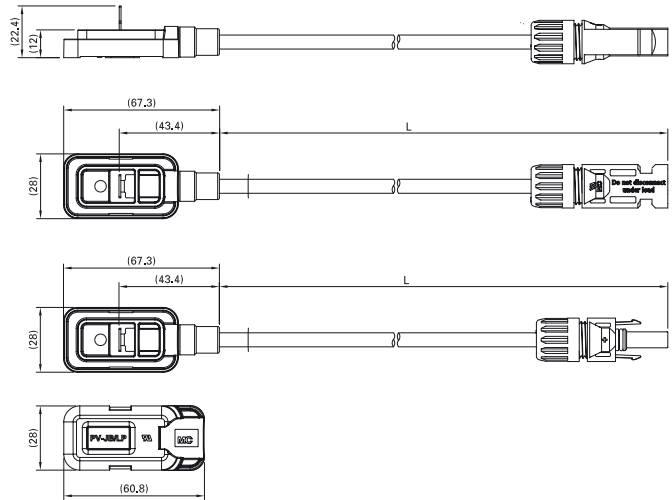
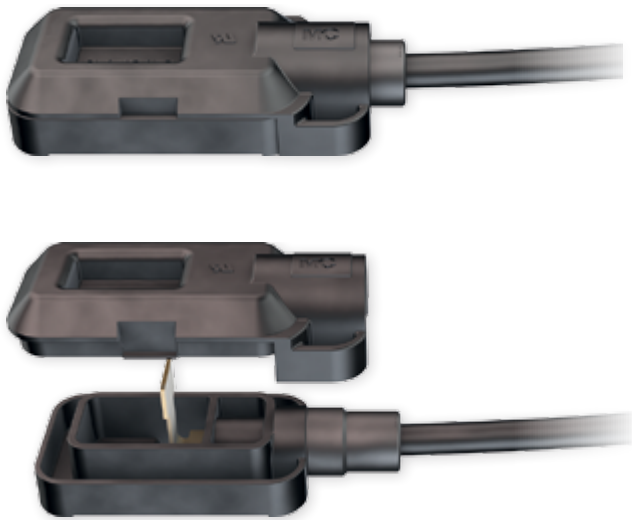

## Technische Daten

Steckverbindersystem	Connector system	<b>MC4</b>
Bemessungsstrom ohne Diode mit PV-DE/SP	Rated current without Diode with PV-DE/SP	<b>Max. 30A 9,5A</b>
Bemessungsspannung	Rated voltage	<b>1000V DC (IEC) 600V DC (UL)</b>
Umgebungstemperaturbereich	Ambient temperature range	<b>-40...+85°C</b>
Schutzart, gesteckt ungesteckt	Degree of protection, mated unmated	<b>IP67 IP2X</b>
Kontaktwiderstand der Steckverbinder	Contact resistance of plug connectors	<b>0,35mΩ</b>
Kontaktmaterial	Contact material	<b>Kuper, verzinkt Copper, tin plated</b>
Isolationsmaterial	Insulation material	<b>mPPE</b>
Verriegelungssystem Steckverbinder	Locking system plug connectors	<b>Snap-in (nur/only MC4)</b>
Flammklasse	Flame class	<b>UL94-5VA</b>
TÜV-Zertifiziert UL-Zulassung	TÜV certified UL-Recognized	<b>R60017180 E350378</b>

Geeignet für Modultyp	Intended for Module type	<b>Dünnschicht/Kristalline Thin film/Crystalline</b>
Pole	Poles	<b>1</b>
Dioden	Diodes	<b>-</b>
Anzahl Flachbandleiter	Number of bus ribbons	<b>1</b>
Anschluss der Flachbandleiter	Connection of the bus ribbons	<b>Schweißen oder Löten Welding or Soldering</b>
Installation	Installation	<b>Vergussmasse &amp; Silikon Potting compound &amp; silicone</b>
Geeignet für automatische Montage	Suitable for automated assembly	<b>Ja Yes</b>

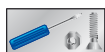

**Sicherungshülse MC4** Seite 53  
**Verschlusskappen** Seite 55  
**Entriegelungsschlüssel** Seite 61

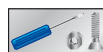

**Safety lock clip MC4** page 53  
**Sealing caps** page 55  
**Unlocking tool** page 61



Montageanleitung **MA272**  
[www.multi-contact.com](http://www.multi-contact.com)



Assembly Instructions **MA272**  
[www.multi-contact.com](http://www.multi-contact.com)

- Leistungsstarke und ausschliesslich mit Silikon zu applizierende Thin Film Single Pole Anschlussdose ausgelegt für einen Bemessungsstrom von maximal 30A
- Nicht Rückstrom sichere Module können bei der zusätzlichen Verwendung eines Diodengehäuses ebenfalls angeschlossen werden. Diese Einheit ist für einen Bemessungsstrom von 9,5A zugelassen.
- Keine Vorschädigung des Laminats bzw. des Glases durch einen vertikal und frei in der Luft stehenden Anschlusskontakt, welcher nach der Kontaktierung mit dem Anschlussband um 90° in den Anschlussraum der Dose gebogen wird.
- Das Design der Anschlussdose erlaubt eine voll automatisierbare Montage
- Durch das Verpotten des Anschlussenraums wird das Gehäuse hermetisch abgedichtet.
- Hohe Schutzart von IP67
- High-power thin film single pole junction box for application only with silicone, with maximum rated current of 30A
- Thermal bypassing capability can be added with the use of optional diode enclosures. Diode enclosures are approved for a rated current of 9,5A.
- Designed specifically for ease of resistance welding, the module ribbon termination is first in a vertical orientated outside of the enclosure. After welding the connection is pressed down into the potting well. Soldering is also possible (by first depressing the contact).
- The design of the junction box allows fully automated assembly.
- The housing is permanently sealed by potting the inner connection chamber.
- High protection class IP67

Typ Type	Bestell-Nr. Order No.	Beschreibung Description	Leiterquerschnitt Cable cross section		Steckverbinder Plug connectors	Leitungsfarbe Cable colour
			mm <sup>2</sup>	L cm		
PV-JB/LP/N4RS/...	32.7246-023*	Anschlussdosen-Set ohne Dioden-Gehäuse Junction box set without Diode enclosure	4	23	MC4	21
PV-JB/LP/N4RS/...+DE/LP/45V/8A	32.7247-023*	Anschlussdosen-Set mit Dioden-Gehäuse Junction box set with Diode enclosure				

**Zubehör**

**Accessories**

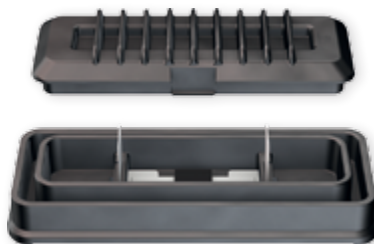

PV-DE/LP-45V/8A

PV-DE/LP-45V/8A	32.7941	Dioden-Gehäuse/Diode enclosure
-----------------	---------	--------------------------------

\* Bitte den Farbcode angeben

\* Add the desired colour code

## Solarkabel FLEX-SOL-XL

## Solar Cable FLEX-SOL-XL

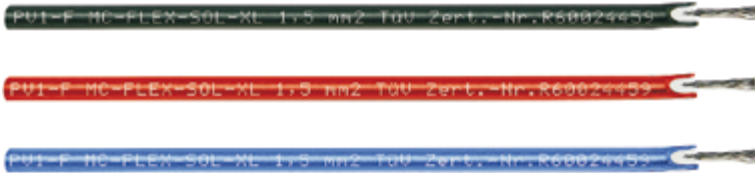

<b>Elektrische Daten</b>	<b>Electrical data</b>	
Nennspannung	Nominal voltage	<b>U<sub>0</sub>/U: 0,6/1kV AC/max. 1,8kV DC</b>
Prüfspannung, gemäss EN 50395-6	Test voltage according to EN 50395-6	<b>6,5kV AC/15kV DC (5min.)</b>
Bemessungsstrom	Rated current	<b>2,5mm<sup>2</sup>: 41A; 4mm<sup>2</sup>: 55A 6mm<sup>2</sup>: 70A; 10mm<sup>2</sup>: 98A</b>
Bemessungsspannung	Rated voltage	<b>1000V DC</b>
Isolationswiderstand der vollständigen Leitung gemäss EN 50395-8.2	Insulation resistance of the complete cable according to EN 50395-8.2	<b>10<sup>14</sup> Ωcm (20°C)/10<sup>11</sup> Ωcm (90°C)</b>
<b>Thermische und mechanische Eigenschaften</b>	<b>Thermal and mechanical properties</b>	
Umgebungstemperatur	Ambient temperature	<b>-40°C ... +90°C</b>
Höchste Temperatur am Leiter	Maximum conductor temperature	<b>max. +120°C</b>
Hoch temperaturbeständig	Highly heat resistant	<b>-40°C ... +90°C (&gt; 150.000 Stunden/hours) -40°C ... +105°C (&gt; 70.000 Stunden/hours) -40°C ... +120°C (&gt; 20.000 Stunden/hours)</b>
Erwartete Gebrauchsdauer	Expected usable life	<b>25 Jahre/years</b>
Mechanisch hoch belastbar	Mechanically highly stressable	
Kälteflexibel	Flexible at low temperatures	
Abriebfestigkeit	Abrasion resistance	<b>Sehr gut/Very good</b>
Zugfestigkeit	Tensile strength	<b>18N/mm<sup>2</sup></b>
Reissdehnung	Elongation at rupture	<b>160%</b>
Härte	Hardness	<b>40 Shore D</b>
<b>Widerstandsfähigkeit gegen Umgebungseinflüsse</b>	<b>Resistance to environmental influences</b>	
Beständig gegen...	Resistant to...	<b>UV Ozon/Ozone Hydrolyse/Hydrolysis</b>
Beständigkeit gegen... gemäss IEC 60811-2-1	Resistance to... tested according to IEC 60811-2-1	<b>Säuren, Laugen und Öl (IRM 902) Acids, alcalis and oil (IRM 902)</b>
<b>Brandverhalten</b>	<b>Fire behaviour</b>	
Isolation	Insulation	<b>flammwidrig mit besonders geringer Rauchentwicklung flame retardant with particularly low smoke emission</b>
<b>Kabelaufbau</b>	<b>Cable structure</b>	
Leiter: feindrähtig verzinnnte Kupferlitzen; Anzahl grösser als Normvorgabe	Conductor: fine-wire tinned copper strands Number larger than standard	<b>Klasse 5 gemäss IEC/EN 60228 Wire class 5 in accordance to IEC/EN 60228</b>
Innenisolierung (naturfarben) Mantelisolierung, mit Farbzusatz (schwarz, rot oder blau)	Inner insulation (natural-coloured) Sheath insulation, with colour patch (black, red or blue)	<b>Polyolefin (Chemisch vernetztes Compound) Polyolefin (Chemically linked compound)</b>
<b>Zulassungen</b>	<b>Approvals</b>	
TÜV-zertifiziert, geprüft nach 2 PFG 1169/08.07	TÜV certified, tested according to 2 PFG 1169/08.07)	<b>TÜV-Zertifikat-Nr. R 60024459 TÜV Certificate No. R 60024459</b>

Einpoliges, doppelt isoliertes Solarkabel mit feindrähtigen verzinnnten Kupferlitzen. Die robuste, flexible und platzsparende Konstruktion von FLEX-SOL-XL gewährleistet gleichbleibende elektrische und mechanische Eigenschaften über die gesamte Lebensdauer der PV-Installation.

Für die Isolierung unserer FLEX-SOL-XL-Leitungen verwenden wir ein chemisch vernetztes Compound, welches eine vollständige und kontrollierte Tiefenvernetzung über die gesamte Kabelmanteldicke aufweist.

Durch die Vernetzung auf chemischem Wege ergibt sich insgesamt eine hohe Prozesssicherheit und Reproduzierbarkeit sowie Material-Homogenität, was den FLEX-SOL-XL-Leitungen ihre hervorragenden mechanischen und thermischen Eigenschaften verleiht: Mechanisch hoch belastbar, hoch temperaturbeständig und kälteflexibel.

Darüber hinaus sind unsere FLEX-SOL-XL-Leitungen flammwidrig, halogenfrei, RoHS-konform und mit besonders geringer Rauchentwicklung im Brandfall.

**Typische Anwendung**

Einsatz im Niederspannungsbereich für hoch beanspruchbare Verkabelungen im Freien. In Kombination mit dem MC Steckverbindersystem für die Photovoltaik: Konfektionierung von Verbindungsleitungen für die zeitsparende Verkabelung von PV-Modulen.

Single-pole, double insulated solar cable with fine-wire tinned copper strands. The robust, flexible and space-saving design of FLEX-SOL-XL ensures constant electrical and mechanical properties during the whole life of the PV installation.

For the insulation of our FLEX-SOL-XL cables we use a chemically cross-linked compound. This exhibits complete and controlled in-depth cross-linking throughout the thickness of the cable sheath.

Cross-linking by chemical means results in a high overall process reliability and reproducibility and material homogeneity to which FLEX-SOL-XL cables owe their outstanding mechanical and thermal characteristics: high mechanical strength, high temperature resistance and flexibility under cold conditions.

FLEX-SOL-XL cables are also flame retardant, halogen-free, RoHS-conform and with particularly low smoke emission in case of fire.

**Typical application**

Use in the low-voltage field for heavy-duty outdoor wiring. In combination with the MC plug connector system for photovoltaics (PV): Assembly of connecting leads for time-saving cabling of PV modules.

Typ Type	Bestell-Nr. Order No.	Verpackungseinheit Packaging unit			Leiterquerschnitt Conductor cross section	Leiter-Ø Conductor Ø	Aussen-Ø Outer-Ø	Litzenaufbau: Anzahl x Ø (mm) Strand design: Number x Ø (mm)	Bemessungsstrom <sup>1)</sup> Rated current <sup>1)</sup>	Leiterwiderstand/20°C Conductor resistance/20°C	Farben <sup>2)</sup> Colours <sup>2)</sup>	Zulassungen Approvals			
		Loses Gebinde Bound together	Karton Cardboard box	Einwegspule (max.) Spool									Bestelleinheit/Order unit		
													m	St. à/pcs. at	St. à/pcs. at
<b>FLEX-SOL-XL 2,5</b>	<b>62.7426-001*</b>	...			2,5	2,05	5,1	50xØ0,25	41	7,7	21 				
<b>FLEX-SOL-XL 2,5</b>	<b>62.7426-110*</b>		150m		2,5	2,05	5,1	50xØ0,25	41	7,7					
<b>FLEX-SOL-XL 2,5</b>	<b>62.7426-910*</b>			700m	2,5	2,05	5,1	50xØ0,25	41	7,7					
<b>FLEX-SOL-XL 4,0</b>	<b>62.7427-001*</b>	...			4,0	2,6	5,8	56xØ0,3	55	4,75					
<b>FLEX-SOL-XL 4,0</b>	<b>62.7427-110*</b>		100m		4,0	2,6	5,8	56xØ0,3	55	4,75					
<b>FLEX-SOL-XL 4,0</b>	<b>62.7427-910*</b>			500m	4,0	2,6	5,8	56xØ0,3	55	4,75					
<b>FLEX-SOL-XL 6,0</b>	<b>62.7428-001*</b>	...			6,0	3,2	7,0	84xØ0,3	70	3,39					
<b>FLEX-SOL-XL 6,0</b>	<b>62.7428-110*</b>		75m		6,0	3,2	7,0	84xØ0,3	70	3,39					
<b>FLEX-SOL-XL 6,0</b>	<b>62.7428-910*</b>			400m	6,0	3,2	7,0	84xØ0,3	70	3,39					
<b>FLEX-SOL-XL 10</b>	<b>62.7429-001*</b>	...			10	4,3	8,2	140xØ0,3	98	1,91					
<b>FLEX-SOL-XL 10</b>	<b>62.7429-110*</b>		50m		10	4,3	8,2	140xØ0,3	98	1,91					
<b>FLEX-SOL-XL 10</b>	<b>62.7429-910*</b>			200m	10	4,3	8,2	140xØ0,3	98	1,91					

\* Bitte den Farbcode angeben

<sup>1)</sup> Nennstrom bis +60°C Umgebungstemperatur, darüber siehe Seite 71

<sup>2)</sup> Farbige Kabel auf Anfrage

\* Add the desired colour code

<sup>1)</sup> Nominal current up to +60°C ambient temperature, above this see page 71

<sup>2)</sup> Coloured cables upon request

## Stringleitung PV-K/BC...

## Branch Cable Leads PV-K/BC...

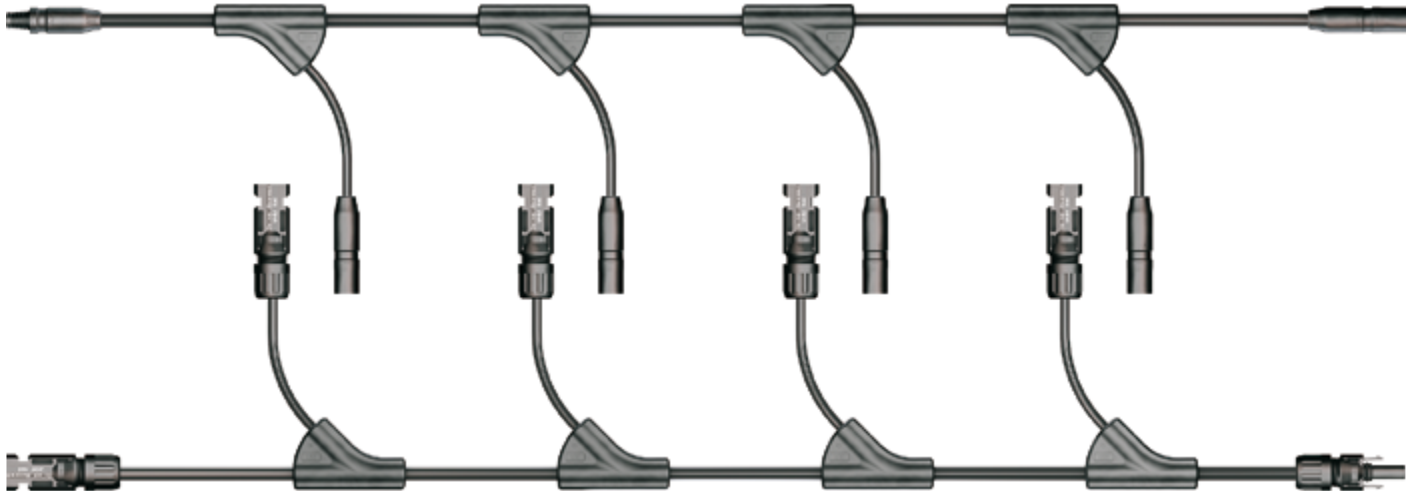

## Technische Daten

## Technical data

Steckverbindersystem	Connector system	<b>MC3/MC4/MC4-EVO 3<sup>1)</sup></b>
Bemessungsspannung	Rated voltage	<b>1000V DC (IEC)</b>
Bemessungsstrom	Rated current	<b>30A</b>
Prüfspannung	Test voltage	<b>6kV (50Hz, 1min.)</b>
Max. zulässige Arbeitsspannung	Maximum permitted operating voltage	<b>&lt; 50V</b>
Umgebungstemperaturbereich	Ambient temperature range	<b>-40°C...+90°C (IEC)</b>
Obere Grenztemperatur	Upper limiting temperature	<b>105°C (IEC)</b>
Schutzart, gesteckt ungesteckt	Degree of protection, mated unmated	<b>IP67 IP2X</b>
Kontaktwiderstand der Steckverbinder	Contact resistance of plug connectors	<b>0,35mΩ (MC4, MC4-EVO 3) / ≤ 0,5mΩ (MC3)</b>
Schutzklasse	Safety class	<b>II</b>
Kontaktsystem	Contact system	<b>MC Kontaktlamellen MC Multilam</b>
Anschlussart	Type of termination	<b>Crimpen Crimping</b>
Kontaktmaterial	Contact material	<b>Kupfer, verzinnt copper, tin plated</b>
Verriegelungssystem	Locking system	<b>Snap-in (MC4)</b>
Leitungstyp	Cable type	<b>FLEX-SOL-XL</b>
Verschmutzungsgrad	Degree of pollution	<b>3</b>
TÜV-Zertifiziert	TÜV certified	<b>R60037242</b>
Prüfnorm	Test standard	<b>DIN V VDE0126-5</b>

<sup>1)</sup> Auf Anfrage<sup>1)</sup> On request



Um die in Solarparks oder auf schrägen Dächern mitunter mühseligen und zeitaufwendigen Montagearbeiten bei der Verkabelung von PV-Modulen zu vereinfachen und zu verkürzen, bietet MC nach individuellem Kundenwunsch fertig konfektionierte Stringleitungen an.

Die Stringleitungen werden zweckmässig verpackt, je nach Länge z. B. aufgerollt, gebunden und/oder in Folie eingeschweisst geliefert und sind an Ort und Stelle nur noch auszuwickeln und anzuschliessen.

Auch „Endlosleitungen“ sind möglich, d. h. der Zuschnitt erfolgt entsprechend der PV-Installation kurzfristig vor Ort. Diese Variante bietet sich für grössere Installationen mit regelmässig angeordneten PV-Modulen an („Rasterlänge“).

Diese Verkabelungsweise ist preiswert, effizient, sicher, zuverlässig und gewährleistet die gewohnt gute MC Qualität.

### Vorteile der Stringleitungen

- Schnelle und effiziente Modulverkabelung, Reduktion der Montagezeit
- Anfertigung nach Kundenspezifikation
- Durchgängiger Hauptstrang, dadurch weniger Kontaktstellen, d. h. geringere Übergangswiderstände
- Vorgefertigt und 100% geprüft durch MC

Typ Type	Beschreibung Description	Bestellformular, siehe Seite Order form, see page	Zulassungen Approvals
PV-K/BC...	Stringleitung, nur nach Kundenwunsch erhältlich Branch cable, according to customer's specification	64	

### Variationsmöglichkeiten

- Kabelquerschnitte<sup>1)</sup> FLEX-SOL-XL  
Hauptstrang/Abzweige: 4,0mm<sup>2</sup>/4,0mm<sup>2</sup>  
6,0mm<sup>2</sup>/2,5mm<sup>2</sup>
- Anzahl der Abzweige max. 80
- Länge der Abzweige (25 – 120cm)<sup>2)</sup>
- Besondere Längen<sup>4)</sup> am Anfang/am Ende des Hauptstrangs sowie individuelle Längen<sup>4)</sup> der Strangabschnitte (max. Gesamtlänge 100m)<sup>3)</sup>
- Gegebenenfalls definierte Rasterlänge für Strangabschnitte<sup>4)</sup>, auch „Endlosleitungen“ sind möglich (max. 100m)<sup>3)</sup>
- Abschluss des Hauptstrangs und der Abzweige:
  - MC3/MC4 Steckverbinder,
  - MC4-EVO 3 Steckverbinder (nur Abzweige)
  - ohne Steckverbinder (gerade abgeschnitten oder millimetergenau abisoliert)
  - kundenspezifisch nach Absprache
- Optional: Verschlusskappen auf allen Steckverbindern (Abschlüsse aller Abzweige und des Hauptstrangs)

### Hinweis

Wir empfehlen die Verwendung von Verschlusskappen, um die Steckverbinder im ungesteckten Zustand vor Verschmutzung zu schützen.

<sup>1)</sup> Weitere Querschnitte ggf. auf Anfrage

<sup>2)</sup> Toleranz Abzweige: ±30mm

<sup>3)</sup> Grössere Längen nach Absprache

<sup>4)</sup> Mindestlänge je Teilstrang: 25cm, Toleranz je Teilstrang: -50mm/+10mm

In order to simplify and shorten the labor intensive and time-consuming assembly work in solar parks or on sloping roofs MC offers individual customized mounted branch cable leads.

The branch cable leads are packed in a manner appropriate to their length, i.e. rolled, bundled and/or welded into plastic film, and need only to be unpacked and connected at their place of installation.

“Endless leads” are also possible, i.e. the cables are cut to the length required for the PV installation on-site shortly before they are needed. This variant is suitable for relatively large installations with regularly spaced PV modules (“grid length”).

This cabling method is inexpensive, efficient, safe, reliable and ensures the accustomed good MC quality.

### Advantages of branch cable leads

- Fast and efficient module wiring, reduced assembly time
- Fabrication according to customer specification
- Continuous main cable reducing the number of contact points, thereby reducing contact resistance
- Pre-assembled and 100% inspected by MC

### Variation possibilities

- Cross sections<sup>1)</sup> FLEX-SOL-XL  
Main cable/branch cables: 4,0mm<sup>2</sup>/4,0mm<sup>2</sup>  
6,0mm<sup>2</sup>/2,5mm<sup>2</sup>
- Number of branches max. 80
- Length of branches (25 – 120cm)<sup>2)</sup>
- Special lengths<sup>4)</sup> at the beginning/end of the main cable and lengths<sup>4)</sup> of the individual cable strings (max. overall length 100m)<sup>3)</sup>
- If appropriate, defined grid length for cable string<sup>4)</sup>, “endless” cables are also possible (max. 100m)<sup>3)</sup>
- Termination of the main cable and branches:
  - MC3/MC4 connectors,
  - MC4-EVO 3 connectors (branches only)
  - without connectors (cut off straight or stripped to a precise length)
  - as agreed with individual customer.
- Optional: Sealing caps on all connectors (of all branches and of the main cable)

### Note

We recommend using the sealing caps in order to protect the connectors from soiling when unmated.

<sup>1)</sup> Other cross-sections on inquiry

<sup>2)</sup> Branch tolerance: ±30mm

<sup>3)</sup> Greater lengths by agreement

<sup>4)</sup> Minimum length per cable section: 25cm  
Tolerance per cable section: -50mm/+10mm

**Adapterleitungen** **Adapter leads**

**Adapter-Messleitung MC3 und MC4**

Eine Seite MC PV-Steckverbinder, andere Seite Ø 4mm MC Sicherheitsstecker für Messgeräte mit Ø 4mm Sicherheitsbuchsen zur sicheren Strom- und Spannungsmessung an PV-Modulen und Anlagen.

**Adapter test lead MC3 and MC4**

One end equipped with MC PV connector, the other end with Ø 4mm MC safety plug for measuring instruments with Ø 4mm safety sockets ensuring safe current and voltage measuring on PV-modules and systems.

**PV-AMLB3/150**



**PV-AMLB4/150**



**PV-AMLS3/150**



**PV-AMLS4/150**



**Technische Daten**

**Technical data**

Steckverbindersystem	Connector system	<b>MC3, MC4</b>
Bemessungsspannung	Rated voltage	<b>1000V DC</b>
Bemessungsstrom	Rated current	<b>19A</b>
Leiterquerschnitt	Conductor cross section	<b>1mm<sup>2</sup></b>
Leitungslänge	Cable length	<b>150cm</b>
Leitungsisolations	Cable insulation	<b>PVC</b>
Überspannungskat./Verschmutzungsgrad	Overvoltage category/Pollution degree	<b>CATIII/2</b>

Typ Type	Bestell-Nr. Order No.	PV-Stecker PV plug	PV-Buchse PV socket	MC System MC System	Farben Colours
<b>PV-AMLB3/150</b>	<b>32.1098-150*</b>		×	MC3	<span style="background-color: black; color: white; padding: 2px;">21</span> <span style="background-color: blue; color: white; padding: 2px;">23</span> <span style="background-color: gray; color: white; padding: 2px;">29</span>
<b>PV-AMLS3/150</b>	<b>32.1099-150*</b>	×		MC3	<span style="background-color: black; color: white; padding: 2px;">21</span> <span style="background-color: red; color: white; padding: 2px;">22</span>
<b>PV-AMLB4/150</b>	<b>32.1198-150*</b>		×	MC4	<span style="background-color: black; color: white; padding: 2px;">21</span> <span style="background-color: blue; color: white; padding: 2px;">23</span> <span style="background-color: gray; color: white; padding: 2px;">29</span>
<b>PV-AMLS4/150</b>	<b>32.1199-150*</b>	×		MC4	<span style="background-color: black; color: white; padding: 2px;">21</span> <span style="background-color: red; color: white; padding: 2px;">22</span>

\* Bitte den Farbcode angeben

\* Add the desired colour code



**Verschlusskappen** Seite 54, 55  
**Sicherungshülse** Seite 53

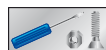

**Sealing caps** page 54, 55  
**Safety lock clip** page 53

### Adapterleitung MC3/MC4

Zur Verbindung der beiden MC PV-Steckverbindersysteme MC3 und MC4 (MC4-EVO 3) untereinander.

### Adapter lead MC3/MC4

To interconnect the two MC PV-Plug connector systems MC3 and MC4 (MC4-EVO 3).

**PV-A-KBT4/KST3**

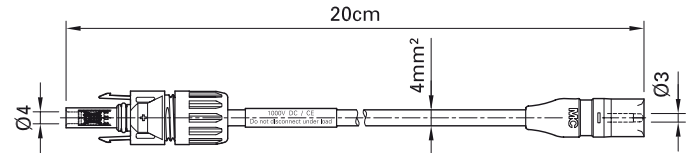

**PV-A-KBT3/KST4**

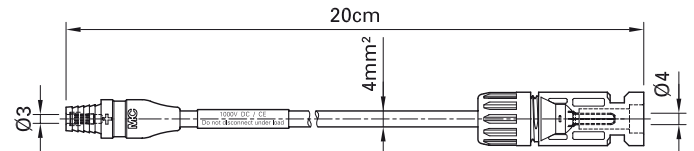

#### Technische Daten

Steckverbindersystem	Connector system	<b>MC3/MC4</b>
Bemessungsspannung	Rated voltage	<b>1000V DC</b>
Bemessungsstrom	Rated current	<b>20A</b>
Schutzart, gesteckt ungesteckt	Degree of protection, mated unmated	<b>IP67 IP2X</b>
Umgebungstemperaturbereich	Ambient temperature range	<b>-40°C...+90°C (IEC)</b>
Obere Grenztemperatur	Upper limiting temperature	<b>105°C (IEC)</b>
Überspannungskat./Verschmutzungsgrad	Overvoltage category/Pollution degree	<b>CATIII/2</b>
Weitere technische Daten, siehe Seiten	Further technical data, see pages	<b>12, 14</b>

#### Technical data

Steckverbindersystem	Connector system	<b>MC3/MC4</b>
Bemessungsspannung	Rated voltage	<b>1000V DC</b>
Bemessungsstrom	Rated current	<b>20A</b>
Schutzart, gesteckt ungesteckt	Degree of protection, mated unmated	<b>IP67 IP2X</b>
Umgebungstemperaturbereich	Ambient temperature range	<b>-40°C...+90°C (IEC)</b>
Obere Grenztemperatur	Upper limiting temperature	<b>105°C (IEC)</b>
Überspannungskat./Verschmutzungsgrad	Overvoltage category/Pollution degree	<b>CATIII/2</b>
Weitere technische Daten, siehe Seiten	Further technical data, see pages	<b>12, 14</b>

Typ Type	Bestell-Nr. Order No.
<b>PV-A-KBT4/KST3</b>	<b>32.6096</b>
<b>PV-A-KBT3/KST4</b>	<b>32.6097</b>

 **Verschlusskappen** Seite 54, 55  
**Sicherungshülse** Seite 53

 **Sealing caps** page 54, 55  
**Safety lock clip** page 53

## Prüfbuchse und -stecker, MC3 und MC4

Spezialausführung mit vergoldeten Kontakten zu Mess- und Prüfzwecken, für hohe Steckzyklen.

**Ohne Verriegelung.**

### PV-KBT3-P AU



### PV-KST3-P AU



## Test socket and plug MC3 and MC4

Special construction with gold plated contacts for test and measurement to achieve higher mating cycles.

**Without locking system.**

### PV-KBT4-P AU



### PV-KST4-P AU



### Technische Daten

Steckverbindersystem	Connector system	MC3, MC4
Bemessungsspannung	Rated voltage	1000V DC (IEC)
Bemessungsstrom	Rated current	20A (MC3) 30A (MC4) 30A: 10AWG
Prüfspannung	Test voltage	6kV (50Hz, 1min.)
Leiterquerschnitt	Conductor cross section	2,5mm <sup>2</sup> ; 4mm <sup>2</sup> (14AWG; 12AWG; 10AWG)
Schutzart, ungesteckt	Degree of protection, unmated	IP2X
Überspannungskat./Verschmutzungsgrad	Overvoltage category/Pollution degree	CATIII/2
Kontaktwiderstand der Steckverbinder	Contact resistance of plug connectors	0,3mΩ
Kontaktmaterial	Contact material	Kupfer, vergoldet Copper, gold plated
Isolationsmaterial	Insulation material	TPE/PA (MC3) PC/PA (MC4)

Typ Type	Bestell-Nr. Order No.	Buchse Socket		Stecker Plug		Passend zu Suitable for	 Montageanleitung Assembly instruction
		MC3	MC4	MC3	MC4		
PV-KBT3-P AU	32.0042	x				PV-KST3..., PV-ADSP3..., PV-AZS3, PV-AZB3	MA259
PV-KST3-P AU	32.0043			x		PV-KBT3..., PV-ADBP3..., PV-AZS3, PV-AZB3	MA259
PV-KBT4II-P AU	32.0044		x			PV-KST4..., PV-ADSP4-S2..., PV-AZS4, PV-AZB4	MA260
PV-KST4II-P AU	32.0045				x	PV-KBT4..., PV-ADBP4-S2..., PV-AZS4, PV-AZB4	MA260

**Prüfstift MC4 PV-PST** **Test plug MC4 PV-PST**

Mit diesem Prüfstift kann auf einfache Weise geprüft werden, ob der Kontakt des MC4 richtig in der Isolation eingerastet ist.

This test plug is used to control the correct location of the MC4 contact in the insulation.

PV-PST



Typ Type	Bestell-Nr. Order No.	 Montageanleitung Assembly instruction
PV-PST	32.6028	MA231, MA232

**Sicherungshülse MC4 PV-SSH4** **MC4 Safety lock clip PV-SSH4**

Die aufsteckbare Sicherungshülse verriegelt die PV-Steckverbindung, so dass sie nur noch mit den Werkzeugen PV-MS... getrennt werden kann.

The pluggable safety lock clip secures the PV connection and can only be unlocked with the tools PV-MS....

PV-SSH4



Sicherungshülse montiert  
Safety lock clip mounted

Typ Type	Bestell-Nr. Order No.	 Montageanleitung Assembly instruction
PV-SSH4	32.5280	MA252

**Technische Daten**

UL-Zulassung

**Technical data**

UL-Recognized

E343181

**Verschlusskappen** **Sealing caps**

**Verschlusskappen MC3**

Verschlusskappen zum dichten Verschliessen von PV-Steckverbindern, die nicht gesteckt sind.  
Verschlusskappen mit Schnur können unverlierbar befestigt werden, indem die Öse einfach über die Leitung gezogen wird.

**Sealing caps MC3**

Sealing caps for tight sealing of unplugged PV connectors. To prevent loss, simply push the strap loop over the cable connector.

**PV-BVK3-OL**

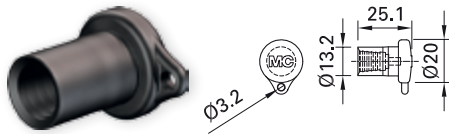

**PV-BVK3**

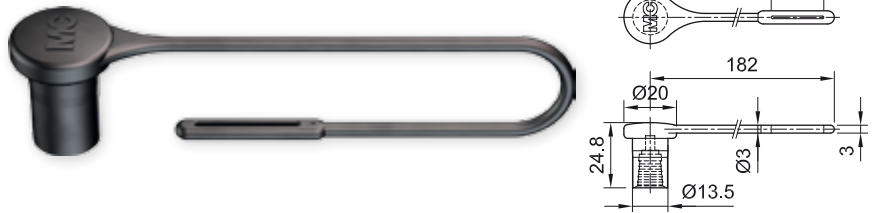

**PV-SVK3-OL**



**PV-SVK3**



**Technische Daten**

Material	
Schutzart, gesteckt	

**Technical data**

Material	<b>TPE</b>
Degree of protection, mated	<b>IP67</b>

Typ Type	Bestell-Nr. Order No.	Mit Schnur With cord	Passend zu Steckerseite Suitable for plug side	Passend zu Buchsenseite Suitable for socket side	MC System MC System
<b>PV-BVK3</b>	<b>32.0710</b>	x		x	MC3
<b>PV-SVK3</b>	<b>32.0711</b>	x	x		MC3
<b>PV-BVK3-OL</b>	<b>32.0720</b>			x	MC3
<b>PV-SVK3-OL</b>	<b>32.0721</b>		x		MC3

### Verschlusskappen MC4

Verschlusskappen zum dichten Verschliessen von PV-Steckverbindern, die nicht gesteckt sind.

### Sealing caps MC4

Sealing caps for tight sealing of unplugged PV connectors.

**PV-BVK4**

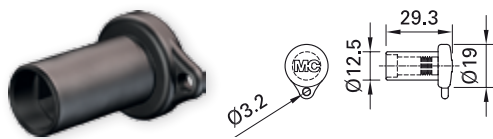

**PV-SVK4**

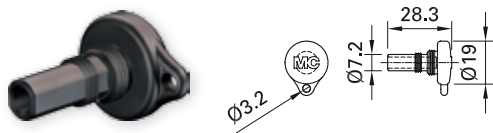

**Technische Daten**

Material  
Schutzart, gesteckt

**Technical data**

Material  
Degree of protection, mated

**TPE**  
**IP67**

Typ Type	Bestell-Nr. Order No.	Passend zu Steckerseite Suitable for plug side	Passend zu Buchsenseite Suitable for socket side	MC System MC System
<b>PV-BVK4</b>	<b>32.0716</b>		×	MC4, MC4-EVO 3
<b>PV-SVK4</b>	<b>32.0717</b>	×		MC4, MC4-EVO 3

## Montagewerkzeuge

## Assembly tools

## Abisolierzange PV-AZM-...

Mit Längenanschlag für die Querschnitte 1,5mm<sup>2</sup>, 2,5mm<sup>2</sup>, 4mm<sup>2</sup>, 6mm<sup>2</sup> und 10mm<sup>2</sup>. Speziell geeignet für die FLEX-SOL-XL PV Leitung zum Abisolieren kleiner Mengen auf der Baustelle.

## PV-AZM-...

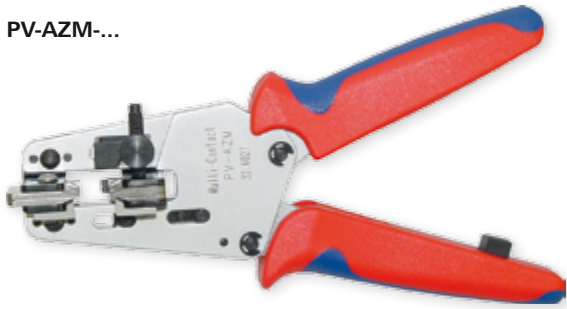

## Stripping pliers PV-AZM-...

With length stop for conductor cross sections 1,5mm<sup>2</sup>, 2,5mm<sup>2</sup>, 4mm<sup>2</sup>, 6mm<sup>2</sup> and 10mm<sup>2</sup>. Specially adapted for the FLEX-SOL-XL PV cable, for stripping small cable quantities on the roof.

Typ Type	Bestell-Nr. Order No.	Bezeichnung Designation	für Leiterquerschnitt for cable cross sections mm <sup>2</sup>	 Montageanleitung Assembly instruction
<b>PV-AZM-156</b>	<b>32.6027-156</b>	Zange mit Einsatz/Pliers with Insert	1,5; 2,5; 4; 6	MA207, MA223, MA232, MA259, MA260
<b>PV-AZM-410</b>	<b>32.6027-410</b>	Zange mit Einsatz/Pliers with Insert	4; 6; 10	MA231, MA268

## Einzelteile

## Individual parts

PV-M-AZM-156



PV-M-AZM-410



PV-M-AZM-156	32.6057-156	Einsatz/Insert	1,5; 2,5; 4; 6	MA207, MA223, MA232, MA259, MA260
PV-M-AZM-410	32.6057-410	Einsatz/Insert	4; 6; 10	MA231, MA268



### Crimpzangen PV-CZ...

Für die Montage der UL zugelassenen Produkte dürfen nur die untenstehenden Werkzeuge verwendet werden.

### Crimping pliers PV-CZ...

Only the tools stated below may be used for the assembly of UL-approved products.

#### PV-CZ



#### PV-CZM...



Typ Type	Bestell-Nr. Order No.	Bezeichnung Designation	Crimpbereich Crimp range		geeignet für suitable for		Montageanleitung Assembly instruction
			mm <sup>2</sup>	AWG	MC3	MC4	
<b>PV-CZ</b>	<b>32.6008</b>	1)	2,5; 4	–	×		MA207, MA223
<b>PV-CZM-16100A</b>	<b>32.6020-16100A</b>	2)	2,5; 4; 6	14; 12; 10	×		MA251
<b>PV-CZM-17100</b>	<b>32.6020-17100</b>	2)	4; 10	–	×		MA207, MA223, MA251, MA268
<b>PV-CZM-18100</b>	<b>32.6020-18100</b>	2)	1,5; 2,5; 4	14; 12		×	MA251
<b>PV-CZM-19100</b>	<b>32.6020-19100</b>	2)	2,5; 4; 6	12; 10		×	MA251
<b>PV-CZM-20100</b>	<b>32.6020-20100</b>	2)	4; 10	–		×	MA251
<b>PV-CZM-21100</b>	<b>32.6020-21100</b>	2)	6; 10	–		×	MA251

#### Einzelteile, nur für PV-CZM...

#### Individual parts, only for PV-CZM...

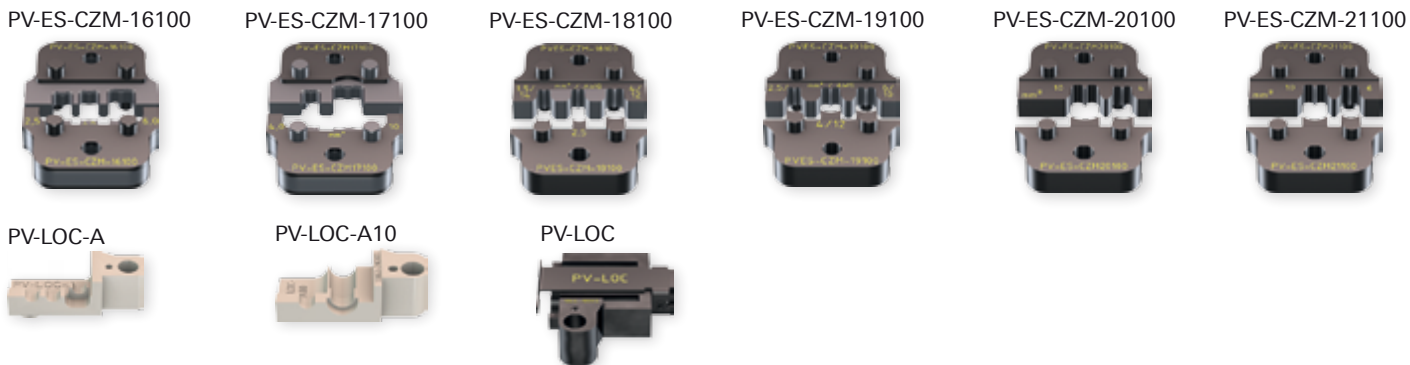

PV-ES-CZM-16100	32.6021-16100	Einsatz/Insert	2,5; 4; 6	14; 12; 10	×	MA251	
PV-ES-CZM-17100	32.6021-17100	Einsatz/Insert	4; 10	–	×	MA207, MA223, MA251, MA268	
PV-LOC-A	32.6039	Locator	2,5; 4; 6	–	×	MA251	
PV-LOC-A10	32.6049	Locator	4; 10	–	×	MA207, MA223, MA251, MA268	
PV-ES-CZM-18100	32.6021-18100	Einsatz/Insert	1,5; 2,5; 4	14; 12		×	MA251
PV-ES-CZM-19100	32.6021-19100	Einsatz/Insert	2,5; 4; 6	12; 10		×	MA251
PV-ES-CZM-20100	32.6021-20100	Einsatz/Insert	4; 10	–		×	MA251
PV-ES-CZM-21100	32.6021-21100	Einsatz/Insert	6; 10	–		×	MA251
PV-LOC	32.6040	Locator	–	–		×	MA251

1) Nur für flexible Leitungen Klasse 5 und 6  
2) Crimpzange inkl. Locator und Einsatz

1) For flexible cable only (class 5 and 6)  
2) Crimping pliers incl. locator and insert

## Montagegerät MC3 PV-RWZ3

Zur leichten Montage der Kupplungssteckverbinder PV-KBT3... und PV-KST3..., für Leiterquerschnitte von 2,5mm<sup>2</sup> bis 6mm<sup>2</sup>. Geeignet für die Montage vor Ort, z.B. auf dem Dach etc.

Für die Montage der UL zugelassenen Produkte darf nur dieses Werkzeug und dazu gehörende Einzelteile verwendet werden.

## MC3 Assembly device PV-RWZ3

For assembly of the cable coupler PV-KBT3... and PV-KST3... for conductor cross sections from 2,5mm<sup>2</sup> to 6mm<sup>2</sup>. Suitable for on-site use, e.g. on the roof etc.

For the assembly of UL-certified products, only this tool and components belonging to it may be used.

### PV-RWZ3



Pos. Pos.	Typ Type	Bestell-Nr. Order No.	Bezeichnung Designation
1 + 2 + 3	PV-RWZ3	32.6050	Montagegerät inkl. 2 Konen Assembly device incl. 2 tapered spindles

### Einzelteile

### Individual parts

1	PV-R-RWZ3	32.6051	Montagegerät/Assembly device
2	PV-KO3 I+II	32.6052	Konus für Isolationen Gr. I+II, bis Aussen-Ø 6,6mm Tapered spindle for insulators size I+II, up to outer-Ø 6,6mm
3	PV-KO3 III	32.6053	Konus für Isolationen Gr. III, bis Aussen-Ø 7,6mm Tapered spindle for insulators size III, up to outer-Ø 7,6mm



Montageanleitungen **MA207, MA259**  
[www.multi-contact.com](http://www.multi-contact.com)



Assembly Instructions **MA207, MA259**  
[www.multi-contact.com](http://www.multi-contact.com)

## Montagegerät MC3 PV-AWZ3

Zur Montage der Kupplungssteckverbinder PV-KBT3... und PV-KST3..., für Leiterquerschnitte von 2,5mm<sup>2</sup> bis 10mm<sup>2</sup>.

Durch die leichte Bauweise und den Sicherungsring speziell für die Montage auf dem Dach geeignet. Mitgelieferte Einsatzdorne werden sicher im abnehmbaren Magazin arretiert.

## MC3 Assembly device PV-AWZ3

For assembly of cable couplers PV-KBT3... and PV-KST3..., for conductor cross sections from 2,5mm<sup>2</sup> to 10mm<sup>2</sup>.

This feature combined with the keyring to secure the tool makes this ideal for use in assembly on rooftops. The included tapered spindles will be delivered fixed in a removable magazine.

### PV-AWZ3



Pos. Pos.	Typ Type	Bestell-Nr. Order No.	Bezeichnung Designation
	<b>PV-AWZ3</b>	<b>32.6060</b>	Montagegerät, inkl. Pos. 1–5 Assembly device, incl. pos. 1–5

### Einzelteile

### Individual parts

Pos.	Typ	Bestell-Nr.	Bezeichnung
1	PV-KO 2,5-4	32.6061	Ersatzdorn 2,5; 4mm <sup>2</sup> , bis Aussen-Ø 6,6mm/Spindle 2,5; 4mm <sup>2</sup> , up to outer-Ø 6,6mm
2	PV-KO 6	32.6062	Ersatzdorn 6mm <sup>2</sup> , bis Aussen-Ø 7,6mm/Spindle 6mm <sup>2</sup> , up to outer-Ø 7,6mm
3	PV-KO 10	32.6063	Ersatzdorn 10mm <sup>2</sup> , bis Aussen-Ø 8,4mm/Spindle 10mm <sup>2</sup> , up to outer-Ø 8,4mm
4	PV-AWZ3-ML	32.6064	Magazin leer, abnehmbar/Magazine empty, removable
5	PV-AWZ3-KK	32.6065	Kabelklemmung/Cable grip

### Steckschlüsseinsatz

MC empfiehlt diese Steckschlüssel für eine einfache und sichere Montage der PV-Aufbaudosen.

PV-WZ-AD/GWD

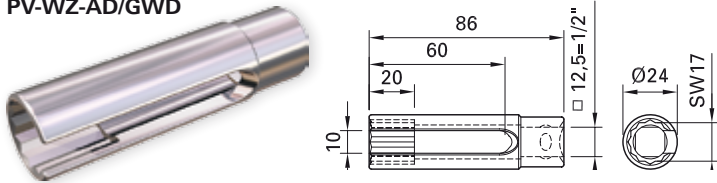

### Socket wrench insert

MC recommends these socket wrench inserts for a simple and safe assembly of the panel receptacles.

PV-SSE-AD4

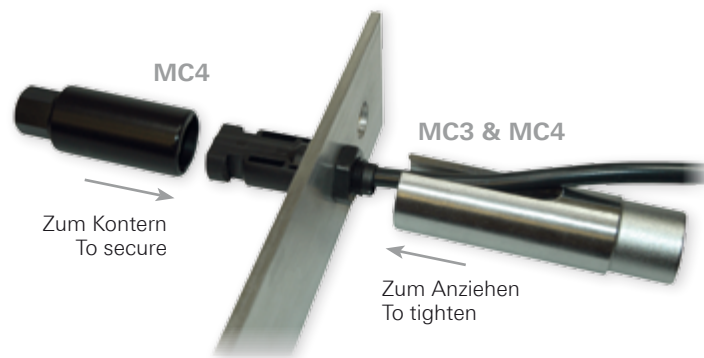
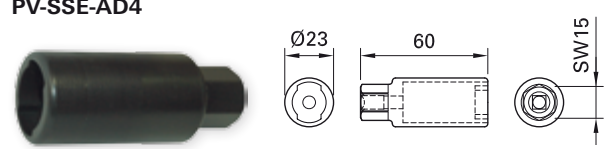

Typ Type	Bestell-Nr. Order No.	geeignet für Aufbaudosen suitable for panel receptacles	MA Montageanleitung Assembly instruction
PV-WZ-AD/GWD	32.6006	MC3, MC4	MA223, MA232
PV-SSE-AD4	32.6026	MC4	MA232

### Montage- und Entriegelungsschlüssel MC4 und MC4-EVO 3

Zum Anziehen und Lösen der Kabelverschraubung sowie zum Lösen der Verriegelung der Steckverbindung.

PV-MS

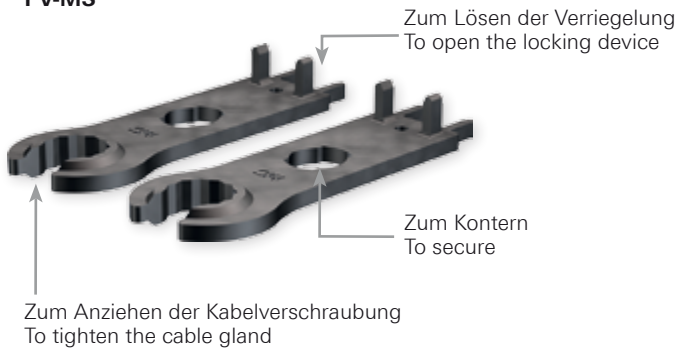

### Open-end spanner and unlocking tool MC4 and MC4-EVO 3

To tighten and unscrew the cable gland and to open the locking device of the connection.

PV-MS-PLS



Typ Type	Bestell-Nr. Order No.	Beschreibung Description	geeignet für suitable for	 Montageanleitung Assembly instruction
<b>PV-MS</b>	<b>32.6024</b>	Montageschlüsselset (bestehend aus 2 Montageschlüsseln), Kunststoff Open-end spanner set (consisting of 2 open-end spanners), plastics	MC4	MA231, MA232, MA260
<b>PV-MS-PLS</b>	<b>32.6058</b>	Entriegelungswerkzeug, inkl. Gürteltasche (bestehend aus 2 Montageschlüsseln), Metall Unlocking tool, incl. belt pouch (consisting of 2 open-end spanners), metal	MC4 MC4-EVO 3	MA270

## Werkzeugkoffer MC3 PV-WZ3-SET

Aus Aluminium mit Schaumstoffeinlage, mit Werkzeugen für die Montage der PV-Steckverbinder. Die aufgeführten Teile gehören zum Lieferumfang.

## Tool case MC3 PV-WZ3-SET

Aluminium case with foam insert and assembly tools. The listed parts are included.

### PV-WZ3-SET



Pos.	Typ	Bestell-Nr.	Beschreibung	Breite	Höhe	Tiefe
Pos.	Type	Order No.	Description	Width	Height	Depth
	<b>PV-WZ3-SET</b>	<b>32.6029</b>	Koffer, inkl. Pos. 1-3/Case, incl. Pos. 1-3	446mm	149mm	333mm

### Einzelteile

### Individual parts

1	PV-CZ	32.6008	Crimpzange/Crimping pliers
2	PV-RWZ3	32.6050	Montagegerät inkl. 2 Konen/Assembly device incl. 2 tapered spindles
3	-	-	Plastikbox/Plastic box

**Werkzeugkoffer MC4 PV-WZ4-SET**

Kunststoffkoffer mit Werkzeugen für die Montage der PV-Steckverbinder.

**MC4 Tool case PV-WZ4-SET**

Plastic case with tools for assembly of PV connectors.

**PV-WZ4-SET**

Pos. Pos.	Typ Type	Bestell-Nr. Order No.	Bezeichnung Designation	Breite Width	Höhe Height	Tiefe Depth
	<b>PV-WZ4-SET</b>	<b>32.6019</b>	Koffer, inkl. Pos. 1–3/Case, incl. Pos. 1–3	345mm	90mm	275mm

**Einzelteile****Individual parts**

1	PV-CZM-19100	32.6020-19100	Crimpzange/Crimping pliers	2,5mm <sup>2</sup> ; 4mm <sup>2</sup> ; 6mm <sup>2</sup> /12AWG; 10AWG
2	PV-MS	32.6024	Montageschlüsselset/Open-end spanner set	
3	–	–	Plastikbox/Plastic box	

**Optional****Optional**

PV-WZ-AD/GWD	32.6006	Steckschlüsseinsatz/Socket wrench insert
PV-SSE-AD4	32.6026	Steckschlüsseinsatz/Socket wrench insert
PV-ES-CZM-...	32.6021-...	Einsatz, s. Seite 57/Insert, see page 57
PV-LOC...	...	Lokator, s. Seite 57/Locator, see page 57
PV-AZM-156	32.6027-156	Abisolierzange/Stripping pliers
PV-AZM-410	32.6027-410	Abisolierzange/Stripping pliers

**Stringleitung PV-K/BC... nach Kundenwunsch**
**Branch cable PV-K/BC... according to customer request**

<input type="text"/>	<b>Stückzahl</b> Quantity	<input type="checkbox"/>	<b>Bestellung</b> Order	<input type="checkbox"/>	<b>Preis Anfrage</b> Quotation	<input type="text"/>	<b>Referenz</b> Reference
----------------------	------------------------------	--------------------------	----------------------------	--------------------------	-----------------------------------	----------------------	------------------------------

**4a** Anfang Hauptstrang  
Beginning of main lead

cm (min. 25cm, max. 1000cm)  
(MC4: min. 28cm, max. 1000cm)

**2** Gesamtlänge  
Overall length

m (min. 0,56m, max. 100m)

**4b** Länge der Teilstränge individuell (min. 25cm)<sup>1)</sup>  
Length of intermediate sections (min. 25cm)<sup>1)</sup>

1	2	3	4	5	6	7	8
16	17	18	19	20	21	22	23

**1** Querschnitt Hauptstrang/Abzweige  
Cross section main cable/branch cables

**A** 4mm<sup>2</sup>/4mm<sup>2</sup>

**B** 6mm<sup>2</sup>/2,5mm<sup>2</sup>

**3** Länge der Abzweige  
Length of branches

cm (min. 25cm, max. 120cm)

**5** Anzahl Abzweige  
Number of branches







(max. 80)

**9** Verschlusskappen  
(auf allen Steckverbindern)  
Sealing caps  
(for all plug connectors)

**Y** mit/with

**N** ohne/without

**6** Anfang Hauptstrang  
Beginning of main lead

	<input type="checkbox"/> <b>S3</b> PV-KST3
	<input type="checkbox"/> <b>B3</b> PV-KBT3
	<input type="checkbox"/> <b>S4</b> PV-KST4
	<input type="checkbox"/> <b>B4</b> PV-KBT4
	<input type="checkbox"/> <b>00</b> Nicht abisoliert (gerader Schnitt) Not stripped (straight cut)
	<input type="checkbox"/> <b>mm</b> Abisolierlänge angeben Indicate length to be stripped
<input type="checkbox"/> <b>X</b>	Kundenspezifisch Customer-specific fabrication

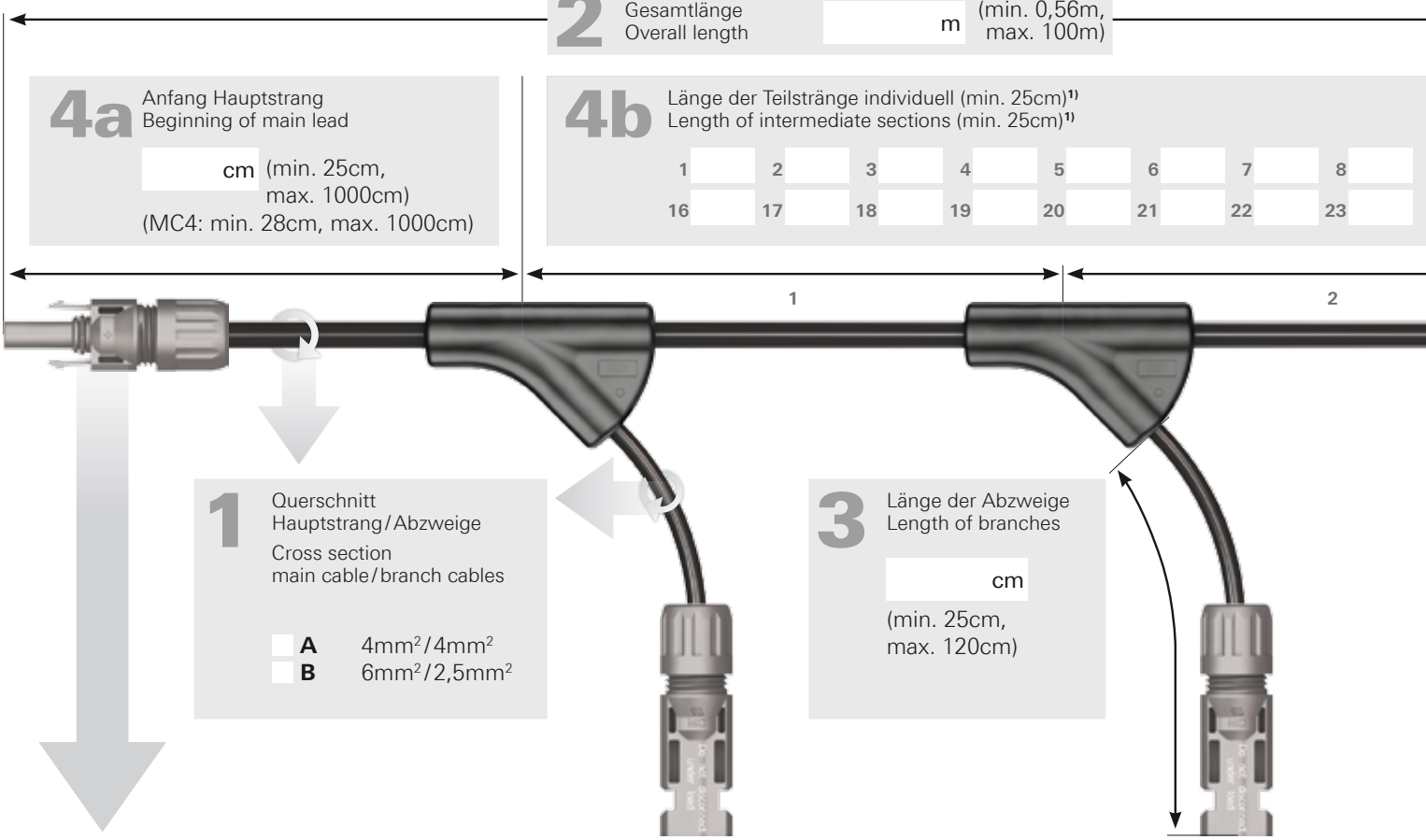

[www](http://www.multi-contact.com)  Interaktives Formular: [www.multi-contact.com](http://www.multi-contact.com)  
> Downloads > Online-Formulare

[www](http://www.multi-contact.com)  Interactive Form: [www.multi-contact.com](http://www.multi-contact.com)  
> Downloads > Online Forms



Um Ihre Artikelbezeichnung zu ermitteln, füllen Sie bitte Kästchen 1 – 9 aus.

Nach der Übermittlung dieses Bestellformulars erhalten Sie eine Freigabeskizze für Ihre endgültige Bestellung.

To determine your article designation, please fill in boxes 1–9. After sending in this order form you will receive an approval sketch for your definitive order.

**PV-K/BC-**



X

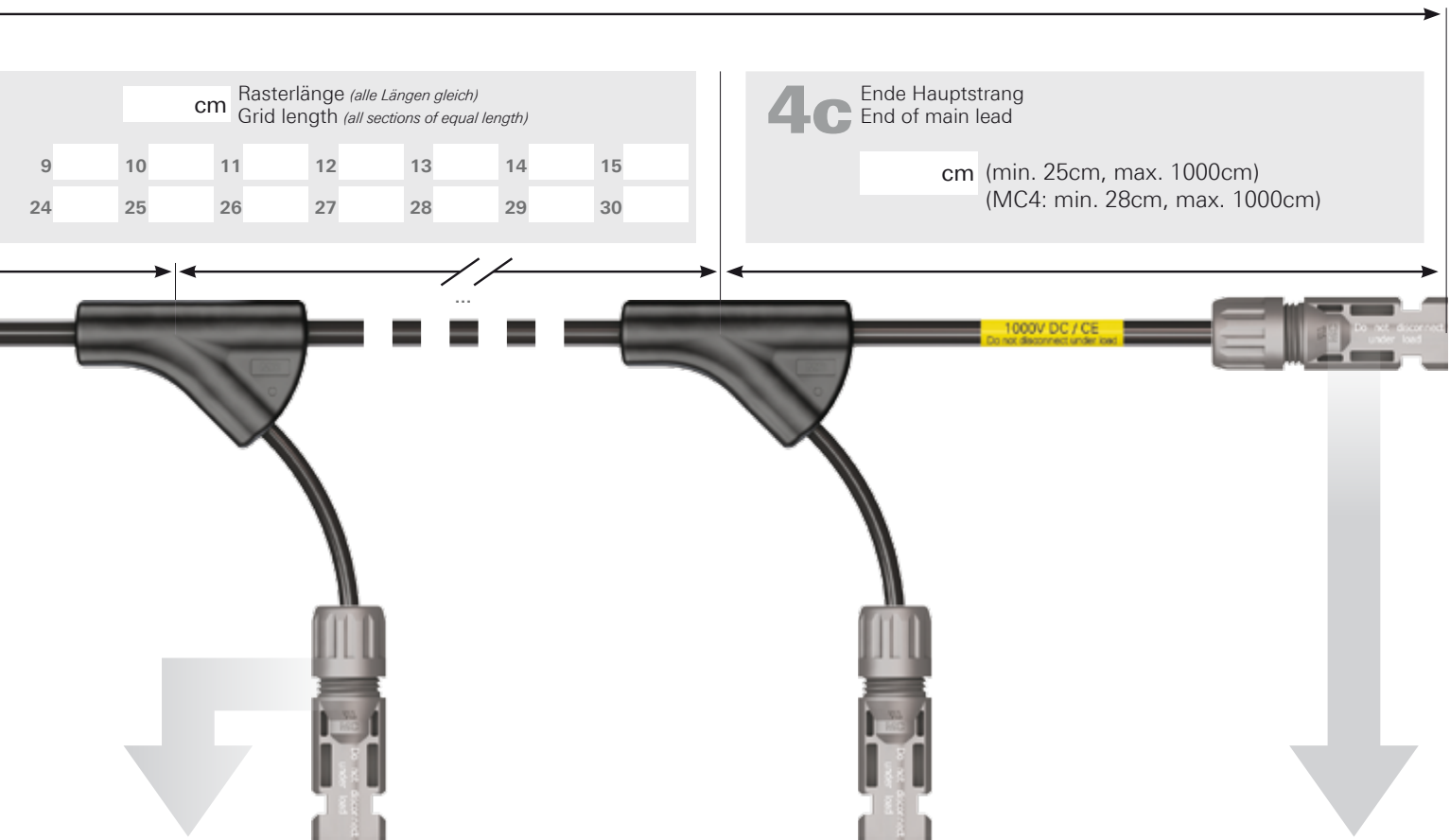

**7** Abschluss der Abzweige  
Termination of branches

	<input type="checkbox"/> <b>S3</b>	PV-KST3
	<input type="checkbox"/> <b>B3</b>	PV-KBT3
	<input type="checkbox"/> <b>S4</b>	PV-KST4
	<input type="checkbox"/> <b>B4</b>	PV-KBT4
	<input type="checkbox"/> <b>S5</b>	PV-PLS-S
	<input type="checkbox"/> <b>B5</b>	PV-PLS-B
	<input type="checkbox"/> <b>00</b>	Nicht abisoliert (gerader Schnitt) Not stripped (straight cut)
	<input type="checkbox"/> <b>mm</b>	Abisolierlänge angeben Indicate length to be stripped
<input type="checkbox"/> <b>X</b>		Kundenspezifisch Customer-specific fabrication

Ende Hauptstrang  
End of main lead

**8**

PV-KST3	<input type="checkbox"/> <b>S3</b>	
PV-KBT3	<input type="checkbox"/> <b>B3</b>	
PV-KST4	<input type="checkbox"/> <b>S4</b>	
PV-KBT4	<input type="checkbox"/> <b>B4</b>	
Nicht abisoliert (gerader Schnitt) Not stripped (straight cut)	<input type="checkbox"/> <b>00</b>	
Abisolierlänge angeben Indicate length to be stripped	<input type="checkbox"/> <b>mm</b>	
Kundenspezifisch Customer-specific fabrication	<input type="checkbox"/> <b>X</b>	









<sup>1)</sup> Bei mehr als 30 Teilsträngen bitte eine zusätzliche Tabelle erstellen.

<sup>1)</sup> For more than 30 sections with individual lengths, please fill in an additional table.

<b>Konfektionierte PV-Leitungen MC3 und MC4</b>	<b>PV-Cable assemblies MC3 and MC4</b>
---	--

Für eine professionelle und sichere Verkabelung empfehlen wir den Einsatz konfektionierter Leitungen.

We recommend Multi-Contact's various cable assemblies for safe and professional cabling.

Typ Type	Bestell-Nr. Order No.	Kupplungsbuchse <sup>1)</sup> Female cable coupler <sup>1)</sup>	Leitungstyp <sup>1)</sup> Cable type <sup>1)</sup>	Kupplungsstecker <sup>1)</sup> Male cable coupler <sup>1)</sup>	Leiterquerschnitt Conductor cross section	Bemessungsstrom Rated current	Zulassungen Approvals	Leitungsfarbe Colour of cable
<b>MC3</b>								
					mm <sup>2</sup>	A		
MC-K2,5SXL/PV-KBT3II/-/...	32.1060- <sup>2)</sup> *	×	FLEX-SOL-XL 2,5		2,5	20	 100% SOLAR GEPRÜFT TYPE APPROVED	21
MC-K2,5SXL/PV-KST3II/-/...	32.1061- <sup>2)</sup> *		FLEX-SOL-XL 2,5	×	2,5	20		
MC-K2,5SXL/PV-KBT3II/PV-KST3II/...	32.1062- <sup>2)</sup> *	×	FLEX-SOL-XL 2,5	×	2,5	20		
MC-K4SXL/PV-KBT3II/-/...	32.1063- <sup>2)</sup> *	×	FLEX-SOL-XL 4,0		4	20		
MC-K4SXL/PV-KST3II/-/...	32.1064- <sup>2)</sup> *		FLEX-SOL-XL 4,0	×	4	20		
MC-K4SXL/PV-KBT3II/PV-KST3II/...	32.1065- <sup>2)</sup> *	×	FLEX-SOL-XL 4,0	×	4	20		
MC-K6SXL/PV-KBT3/6III/-/...	32.1066- <sup>2)</sup> *	×	FLEX-SOL-XL 6,0		6	30		
MC-K6SXL/PV-KST3/6III/-/...	32.1067- <sup>2)</sup> *		FLEX-SOL-XL 6,0	×	6	30		
MC-K6SXL/PV-KBT3/6III/PV-KST3/6III/...	32.1068- <sup>2)</sup> *	×	FLEX-SOL-XL 6,0	×	6	30		
MC-K10SXL/PV-KBT3IV/-/...	32.1069- <sup>2)</sup> *	×	FLEX-SOL-XL 10		10	43		
MC-K10SXL/PV-KST3IV/-/...	32.1070- <sup>2)</sup> *		FLEX-SOL-XL 10	×	10	43		
MC-K10SXL/PV-KBT3IV/PV-KST3IV/...	32.1071- <sup>2)</sup> *	×	FLEX-SOL-XL 10	×	10	43		
<b>MC4</b>								
					mm <sup>2</sup>	A		
MC-K2,5SXL/PV-KBT4I/-/...	32.1130- <sup>2)</sup> *	×	FLEX-SOL-XL 2,5		2,5	22,5	 100% SOLAR GEPRÜFT TYPE APPROVED	21
MC-K2,5SXL/PV-KST4I/-/...	32.1131- <sup>2)</sup> *		FLEX-SOL-XL 2,5	×	2,5	22,5		
MC-K2,5SXL/PV-KBT4I/PV-KST4I/...	32.1132- <sup>2)</sup> *	×	FLEX-SOL-XL 2,5	×	2,5	22,5		
MC-K4SXL/PV-KBT4I/-/...	32.1133- <sup>2)</sup> *	×	FLEX-SOL-XL 4,0		4	30		
MC-K4SXL/PV-KST4I/-/...	32.1134- <sup>2)</sup> *		FLEX-SOL-XL 4,0	×	4	30		
MC-K4SXL/PV-KBT4I/PV-KST4I/...	32.1135- <sup>2)</sup> *	×	FLEX-SOL-XL 4,0	×	4	30		
MC-K6SXL/PV-KBT4I/-/...	32.1136- <sup>2)</sup> *	×	FLEX-SOL-XL 6,0		6	30		
MC-K6SXL/PV-KST4I/-/...	32.1137- <sup>2)</sup> *		FLEX-SOL-XL 6,0	×	6	30		
MC-K6SXL/PV-KBT4I/PV-KST4I/...	32.1138- <sup>2)</sup> *	×	FLEX-SOL-XL 6,0	×	6	30		
MC-K10SXL/PV-KBT4I/-/...	32.1139- <sup>2)</sup> *	×	FLEX-SOL-XL 10		10	43		
MC-K10SXL/PV-KST4I/-/...	32.1140- <sup>2)</sup> *		FLEX-SOL-XL 10	×	10	43		
MC-K10SXL/PV-KBT4I/PV-KST4I/...	32.1141- <sup>2)</sup> *	×	FLEX-SOL-XL 10	×	10	43		



<sup>1)</sup> Sie finden weitere technische Daten zu:  
 Kupplungsstecker, -buchse MC3, siehe Seite 12  
 Kupplungsstecker, -buchse MC4, siehe Seite 14  
 Solarkabel FLEX-SOL-XL, siehe Seite 46

<sup>2)</sup> Bitte Länge in cm angeben  
 \* Bitte den Farbcode angeben

<sup>1)</sup> For more technical data on:  
 Male, female coupler MC3, see page 12  
 Male, female coupler MC4, see page 14  
 Solar cable FLEX-SOL-XL, see page 46

<sup>2)</sup> Please indicate length in cm  
 \* Add the desired colour code

 **Sicherungshülse MC4** Seite 53  
 **Verschlusskappen** Seite 54, 55  
 **Entriegelungsschlüssel MC4** Seite 61

 **Safety lock clip MC4** page 53  
 **Sealing caps** page 54, 55  
 **Unlocking tool MC4** page 61

### Definition der Kabellängen

#### Leitungslängen von konfektionierten Leitungen

Bei der Bestellung von konfektionierten Leitungen ist die Leitungslänge (L) wie in den unten dargestellten Beispielen definiert.

Kupplungsbuchse  
Female cable coupler

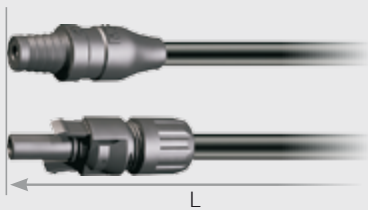

Kupplungsstecker  
Male cable coupler

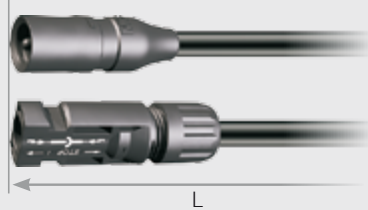

Kabelschuh  
Cable lug



Aufbaudosenbuchse  
Female panel receptacle

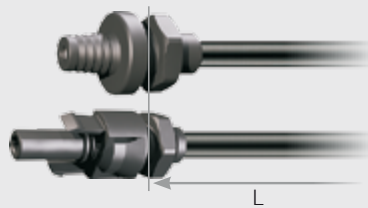

Aufbaudosenstecker  
Male panel receptacle

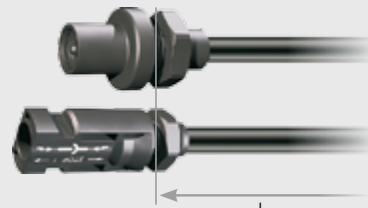

Voll- oder Teilabisolierung  
Complete or partial stripping



#### Bestell-Beispiel:

MC3-Buchse und -Stecker  
Leiterquerschnitt: 2,5mm<sup>2</sup>

32.1062-2)\*

Leitungslänge 50cm

32.1062-050\*

Leitungsfarbe rot

32.1062-05022

Fertige Leitung: **32.1062-05022**

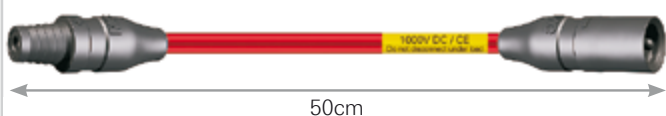

#### Ordering example:

MC3 female and male cable coupler  
Cable cross section: 2,5mm<sup>2</sup>

32.1062-2)\*

Cable length 50cm

32.1062-050\*

Cable colour red

32.1062-05022

Ready-made lead: **32.1062-05022**

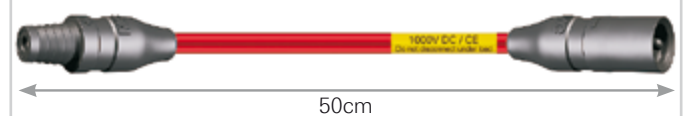

**Konfektionierte Leitungen nach Kundenwunsch** **Cable assemblies according to customer request**

<input type="text"/>	<b>Stückzahl</b> Quantity	<input type="checkbox"/>	<b>Bestellung</b> Order	<input type="checkbox"/>	<b>Preis Anfrage</b> Quotation	<input type="text"/>	<b>Referenz</b> Reference
----------------------	------------------------------	--------------------------	----------------------------	--------------------------	-----------------------------------	----------------------	------------------------------

Seite/Side 1

Leitung/Cable

Seite/Side 2

MC3

PV-KBT3 

PV-KST3 

PV-ADBP3 

PV-ADSP3 

MC4

PV-KBT4 

PV-KST4 

PV-ADBP4-S2 

PV-ADSP4-S2 

MC4-EVO 3

PV-PLS-B 

PV-PLS-S 

**Kabelschuh**  
Cable lug

Ø  

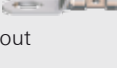
Ø  

Isolation:  ohne/without  
 mit/with

**Teil-Abisolierung**  
Partial stripping



Length:  (max. 45mm)  
Länge:  (max. 45mm)

**Nicht abisoliert**  
Not stripped



**Sonstiges**  
Other

**Leiterquerschnitt (mm²):**  
Cable cross section (mm²):

FLEX-SOL-XL  
 2,5  4  6  10

BETAflam®  
 2,5  4  6

**Farbcode/Colour code:**  
(nur/only FLEX-SOL-XL)  
 21  22  23

**Leitungslänge<sup>1)</sup>/Length of cable<sup>1)</sup>:**  
 cm

**Absender/Sender**

Firma/Company

Name

Abteilung/Department

Adresse/Address

Tel.

Fax

E-Mail

Datum/Date

Unterschrift/Signature

Sonstiges/Other

MC3

PV-KBT3 

PV-KST3 

PV-ADBP3 

PV-ADSP3 

MC4

PV-KBT4 

PV-KST4 

PV-ADBP4-S2 

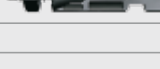
PV-ADSP4-S2 

MC4-EVO 3

PV-PLS-B 

PV-PLS-S 

**Kabelschuh**  
Cable lug

Ø  

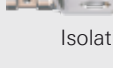
Ø  

Isolation:  ohne/without  
 mit/with

**Teil-Abisolierung**  
Partial stripping



Length:  (max. 45mm)  
Länge:  (max. 45mm)

**Nicht abisoliert**  
Not stripped



**Sonstiges**  
Other

<sup>1)</sup> Definition, s. Seite 67

<sup>1)</sup> Definition, see page 67

**Anschlussdose Westlake nach Kundenwunsch**      **Junction box Westlake according to customer request**

Stückzahl Quantity       Bestellung Order       Preis-anfrage Quotation       Referenz Reference

**MC3**  
 **PV-JB/WL-H**  
 **PV-JB/WL-V**

Querschnitt Cross section: **4mm<sup>2</sup>**

Länge in cm Length in cm:  
L1  (min. 25cm)  
L2  (min. 25cm)

Kabeltyp, -farbe Cable type and colour:  
 **BETAflam®** 21  
 **Byson** 21  
 **FLEX-SOL-XL** 21 22 23

**MC4**  
 **PV-JB/WL-H**  
 **PV-JB/WL-V**

Querschnitt Cross section: **4mm<sup>2</sup>**

Länge in cm Length in cm:  
L1  (min. 25cm)  
L2  (min. 25cm)

Kabeltyp, -farbe Cable type and colour:  
 **BETAflam®** 21  
 **Byson** 21  
 **FLEX-SOL-XL** 21 22 23

**MC4-EVO 3**  
 **PV-JB/WL-H**  
 **PV-JB/WL-V**

Querschnitt Cross section: **4mm<sup>2</sup>**

Länge in cm Length in cm:  
L1  (min. 25cm)  
L2  (min. 25cm)

Kabeltyp, -farbe Cable type and colour:  
 **BETAflam®** 21  
 **Byson** 21  
 **FLEX-SOL-XL** 21 22 23

Modulstrom Module current IMPP: <input type="text"/> A	Modulkurzschlussstrom Module short-circuit current Isc: <input type="text"/> A	Diodyentyp Diode type <input type="text"/>	Sonstiges Other <input type="text"/>
--	--	--	--

**Absender / Sender**

Firma/Company

Name  Abteilung/Department

Adresse/Address

Tel.  Fax

E-Mail

Datum/Date  Unterschrift/Signature

[www](http://www.multi-contact.com) Interaktives Formular: [www.multi-contact.com](http://www.multi-contact.com)  
> Downloads > Online-Formulare

[www](http://www.multi-contact.com) Interactive Form: [www.multi-contact.com](http://www.multi-contact.com)  
> Downloads > Online Forms

**Anschlussdose PV-JB-LC nach Kundenwunsch** **Junction box PV-JB-LC according to customer request**

<input type="text"/>	<input type="checkbox"/> <b>Stückzahl</b> Quantity	<input type="checkbox"/> <b>Bestellung</b> Order	<input type="checkbox"/> <b>Preis Anfrage</b> Quotation	<input type="text"/>	<input type="checkbox"/> <b>Referenz</b> Reference
----------------------	---	---	--	----------------------	---

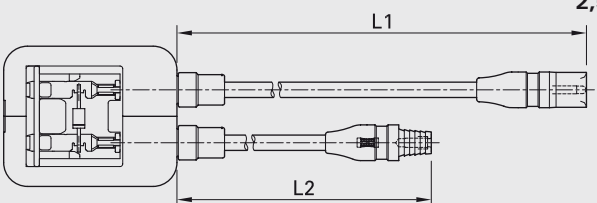
<p><input type="checkbox"/> <b>MC3</b></p>  <p style="text-align: center;"><b>2,5mm<sup>2</sup></b></p>	<p>Querschnitt Cross section</p>	<p>Länge in cm Length in cm</p>	<p>Kabeltyp, -farbe Cable type and colour</p> <p><input type="checkbox"/> <b>BETAflam®</b> <input type="checkbox"/> 21  <input type="checkbox"/> <b>RADOX</b> <input type="checkbox"/> 21  <input type="checkbox"/> <b>FLEX-SOL-XL</b>  <input type="checkbox"/> 21 <input type="checkbox"/> 22 <input type="checkbox"/> 23</p> <p><input type="checkbox"/> <b>BETAflam®</b> <input type="checkbox"/> 21  <input type="checkbox"/> <b>RADOX</b> <input type="checkbox"/> 21  <input type="checkbox"/> <b>FLEX-SOL-XL</b>  <input type="checkbox"/> 21 <input type="checkbox"/> 22 <input type="checkbox"/> 23</p>
<p>L1 <input type="text"/> (min. 50cm)</p> <p>L2 <input type="text"/> (min. 50cm)</p>			

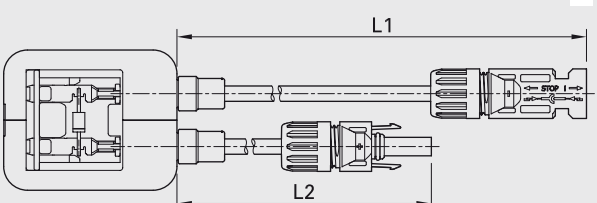
<p><input type="checkbox"/> <b>MC4</b></p>  <p style="text-align: center;"><b>2,5mm<sup>2</sup></b></p>	<p>Querschnitt Cross section</p>	<p>Länge in cm Length in cm</p>	<p>Kabeltyp, -farbe Cable type and colour</p> <p><input type="checkbox"/> <b>BETAflam®</b> <input type="checkbox"/> 21  <input type="checkbox"/> <b>RADOX</b> <input type="checkbox"/> 21  <input type="checkbox"/> <b>FLEX-SOL-XL</b>  <input type="checkbox"/> 21 <input type="checkbox"/> 22 <input type="checkbox"/> 23</p> <p><input type="checkbox"/> <b>BETAflam®</b> <input type="checkbox"/> 21  <input type="checkbox"/> <b>RADOX</b> <input type="checkbox"/> 21  <input type="checkbox"/> <b>FLEX-SOL-XL</b>  <input type="checkbox"/> 21 <input type="checkbox"/> 22 <input type="checkbox"/> 23</p>
<p>L1 <input type="text"/> (min. 50cm)</p> <p>L2 <input type="text"/> (min. 50cm)</p>			

<p>Modulstrom Module current</p> <p>IMPP: <input type="text"/> A</p>	<p>Modulkurzschlussstrom Module short-circuit current</p> <p>Isc: <input type="text"/> A</p>	<p>Diodentyp Diode type</p> <p><input type="text"/></p>	<p>Klebeпад Adhesive pad</p> <p><input type="checkbox"/> vormontiert/pre-assembled  <input type="checkbox"/> separat/separately</p>	<p>Montagewerkzeug Assembly tool</p> <p><input type="checkbox"/> PV-WZ-JB/LC</p>
--	--	---	---	--

**Absender/Sender**

Firma/Company

Name  Abteilung/Department

Adresse/Address

Tel.  Fax

E-Mail

Sonstiges/Other

Datum/Date  Unterschrift/Signature

 Interaktives Formular: [www.multi-contact.com](http://www.multi-contact.com)  
> Downloads > Online-Formulare

 Interactive Form: [www.multi-contact.com](http://www.multi-contact.com)  
> Downloads > Online Forms

**Allgemeine Hinweise** **General information**

Die Überprüfung, ob in speziellen, von uns nicht vorhersehbaren Anwendungsbereichen, die in diesem Katalog gezeigten Produkte anderen als den angegebenen Vorschriften entsprechen, obliegt dem Anwender.

**Änderungen/Vorbehalte**

Alle Daten, Abbildungen und Zeichnungen in diesem Katalog sind das Resultat sorgfältiger Prüfungen. Sie entsprechen dem Stand unserer Erfahrungen. Irrtum vorbehalten. Ebenfalls vorbehalten sind Änderungen aus konstruktions- bzw. sicherheitstechnischen Gründen. Bei der Entwicklung von Geräten in denen unsere Bauteile eingebunden werden, sollte vor Verwendung der Katalogdaten mit uns abgeklärt werden, ob die Daten dem aktuellen Stand entsprechen. Wir beraten Sie gerne.

Users wishing to employ products listed in the catalogue for applications we have not considered are themselves responsible for making certain that the products comply with standards other than those stated.

**Changes/Provisos**

All data, illustrations and drawings in the catalogue have been carefully checked. They are in accordance with our experience to date, but no responsibility can be accepted for errors. We also reserve the right to make modifications for design and safety reasons. When designing equipment incorporating our components, it is therefore advisable not to rely solely on the data in the catalogue but to consult us to make sure this information is up to date. We shall be pleased to advise you.

**Derating Diagramm** **Derating diagram**

**Temperaturabhängigkeit der Strombelastbarkeit**

Die folgende Kurve zeigt die Abhängigkeit der Strombelastbarkeit der FLEX-SOL-XL Leitungen von der Umgebungstemperatur gemäss 2 PFG 1169/08.07. 100% entsprechen jeweils dem angegebenen Bemessungsstrom.

**Temperature-dependence of Current-carrying Capacity**

The following curve shows the correlation between the current-carrying capacity of the FLEX-SOL-XL cable and the ambient temperature according to 2 PFG 1169/08.07. 100% corresponds to the rated current stated.

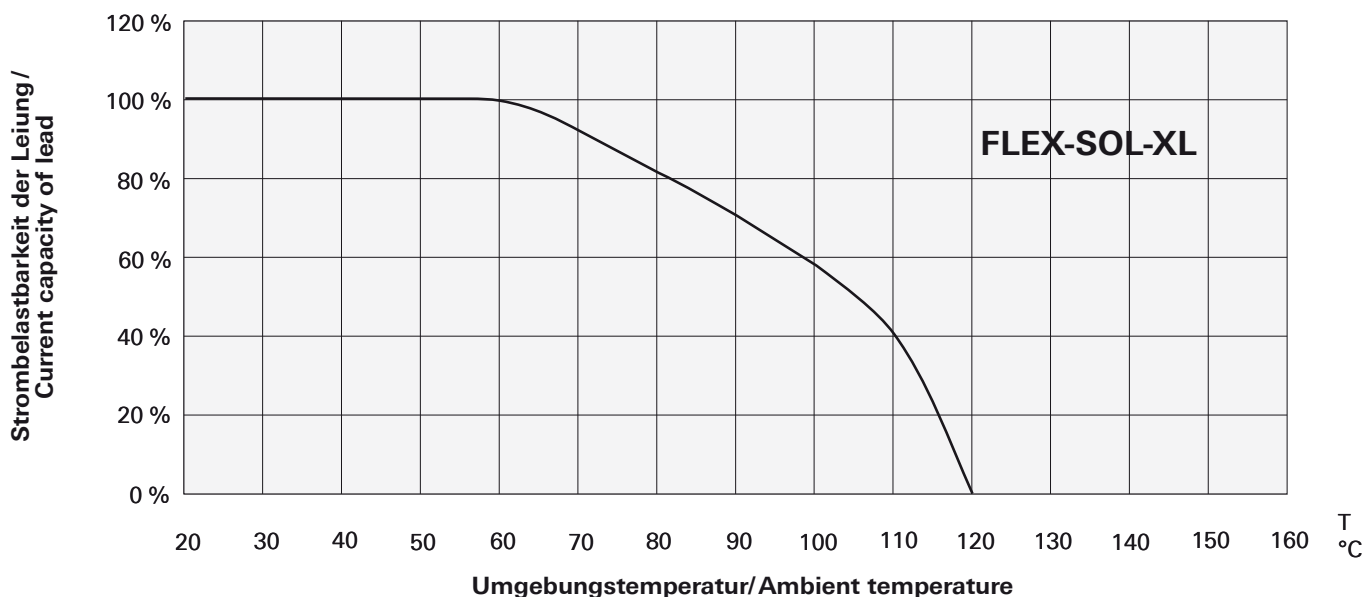

## Technische Hinweise

### Crimpanschlüsse

Für den Leiteranschluss an die Crimphülsen der PV-Steckverbinder empfehlen wir, die angegebenen Crimpwerkzeuge einzusetzen. Für UL zugelassene Produkte können nur die erwähnten Werkzeuge für die Selbstmontage gemäss den Montageanleitungen verwendet werden. Die Crimphülsen sind für flexible Leiter (Klasse 5 und 6) der genannten Querschnittsbereiche ausgelegt. Der Einsatz mehrdrähtiger Leiter (Klasse 2) ist möglich. Verzinnete Leiter sind vorteilhaft.

### Anschlussleitung

Zur Sicherstellung einer ausreichenden Dichtheit des Leitungsausgangs der PV-Steckverbinder sind Anschlussleitungen in den, den Isolationsgehäusen zugewiesenen, Durchmesserbereichen einzusetzen.

### Verlegebedingungen

Ein scharfkantiges Abbiegen der Anschlussleitung am Ausgang der PV-Steckverbinder ist beim Verlegen der PV-Leitungen zu vermeiden. Wir empfehlen die Mindestbiegeradien der Anschlussleitung einzuhalten.

### Steckzyklen

Die maximale Stechkäufigkeit der PV-Steckverbinder beträgt 100 Zyklen.

### Bemessungsstrom

Siehe Derating Diagramm

### Max. Systemspannung

Ist die maximale Spannung für welche die Komponenten des PV-Steckverbindersystems eingesetzt werden dürfen und gemäss IEC 60664-1 bemessen sind.

### Kontaktwiderstand

Ist der an der Berührstelle zweier Kontaktflächen auftretende Widerstand.

### Prüfspannung

Ist die Spannung, bei welcher die Komponenten des PV-Steckverbindersystems bei festgelegten Bedingungen ohne Durch- oder Überschlag im Neuzustand geprüft werden.

### Trennen unter Last

Gesteckte PV-Steckverbindungen dürfen nicht unter Last getrennt werden. Das Stecken und Trennen unter Spannung ist möglich.

### Witterungsschutz

Nicht gesteckte PV-Steckverbinder sind mit einer Verschlusskappe vor Feuchtigkeit und Schmutz zu schützen.

### Orientierung der Anschlussdose

Die Befestigung der Anschlussdosen auf dem PV-Modul hat so zu erfolgen, dass in dessen späterem Gebrauchszustand die Leitungsausgänge der Anschlussdosen nach unten gerichtet sind.

## Technical information

### Crimped terminations

For termination of the conductors to the crimping sleeves of the PV plug connectors we recommend using the stated crimping tools. For UL certified products only the tools mentioned can be used for self-assembly according to the assembly instructions. The crimping sleeves are designed for highly flexible conductors of the stated cross-section ranges. The use of flexible conductors is possible. It is advantageous to use tinned conductors.

### Connecting cables

To ensure that the cable outlets of the PV plug connectors are sufficiently watertight, connecting cables of the specified diameter ranges for the insulating casings must be used.

### Laying conditions

When laying the PV leads, avoid having the connecting cable resting on a sharp edge at the exit from the PV connector. We recommend observing the minimum bending radius of the connecting cables.

### Plugging cycles

The maximum life of the PV connectors is 100 plugging cycles.

### Rated current

See derating diagram

### Max. system voltage

Is the maximum voltage for which the components of the PV plug connector system may be used and are rated in accordance with IEC 60664-1.

### Contact resistance

is the resistance at the point of contact between two contact surfaces.

### Test voltage

Is the voltage at which the new components of the PV plug connector system are tested under defined conditions without breakdown or arcing.

### Unplugging under load

PV plug connections must not be unplugged while under load. Plugging and unplugging while under tension is permitted.

### Protection against weather

Sealing caps must be used to protect unplugged PV-connectors from moisture and dirt.

### Positioning of the junction box

The junction box must be fixed on the PV module in such a position that the cable outlets of the junction box point downwards when in use.



## Weitere technische Angaben zu Leitungen

## Further technical data on leads

### Kleinste zulässige Biegeradien

VDE 0298, Teil 3 trifft Festlegungen über kleinste zulässige Biegeradien von Leitungen. In der folgenden Tabelle sind für fest verlegte und frei bewegliche flexible Leitungen die kleinsten zulässigen Biegeradien zusammengefasst.

Biegeradien	Bend radii	
Bemessungsspannung	Rated voltage	> 600V
Fest verlegt	Fixed	6d
Frei beweglich	Mobile	10d

d = Aussendurchmesser der Leitung

### Smallest Permissible Bend Radii

VDE 0298, part 3, stipulates minimum permissible bend radii of leads. In the following table, the minimum bend radii are shown for fixed and mobile flexible leads.

d = Outside diameter of lead

### Warum verzinnzte Kupferlitzen?

Werden blankweiche Cu-Litzen Temperaturen von > 90°C ausgesetzt, so kann es zu Verfärbungen des Kupfers sowie zur Abnahme der Lötbarkeit dieser Litzen kommen. Ausserdem können Reaktionen des Kupfers mit dem Isoliermaterial auftreten, die die mechanischen Eigenschaften der Leitungen nachteilig beeinflussen.

### Why tinned multistrand copperwires?

If bright-soft copper stranded wires are exposed to temperatures > 90°C, this can result in discoloration of the copper and an impairment of its soldering properties. Reactions between the copper and the insulating material may also occur which have a deleterious effect on the mechanical properties of the flexible leads.

### Leiterwiderstand bei 20°C für Klasse 5-Cu-Leiter

Die folgende Tabelle zeigt den Leiterwiderstand für feindrähtige Kupferleiter mit blanken Einzeldrähchen bei 20°C in Abhängigkeit vom Nennquerschnitt gemäss IEC/EN 60228.

### Resistance of conductor at 20°C for class 5 Cu conductors

The following table shows the conductor resistance for fine-stranded copper wires with bare individual strands at 20°C in relation to the nominal cross-section according to IEC/EN 60228.

Nennquerschnitt Nominal cross section	Leiterwiderstand Conductor resistance
mm <sup>2</sup>	Ω/km
1,5	13,3
2,5	7,98
4,0	4,95
6,0	3,30
10	1,91

### Tabelle mm<sup>2</sup>/AWG

Den Nennquerschnitt unserer Litzenleitungen geben wir in mm<sup>2</sup> an. Die folgende Grafik gibt eine Orientierung für die Vergleichbarkeit mit entsprechenden AWG-Werten.<sup>1)</sup>

### Table mm<sup>2</sup>/AWG

The nominal cross-section of our multi-strand wires is stated in sq. mm. The following chart gives an indication of their comparability with corresponding AWG values.<sup>1)</sup>

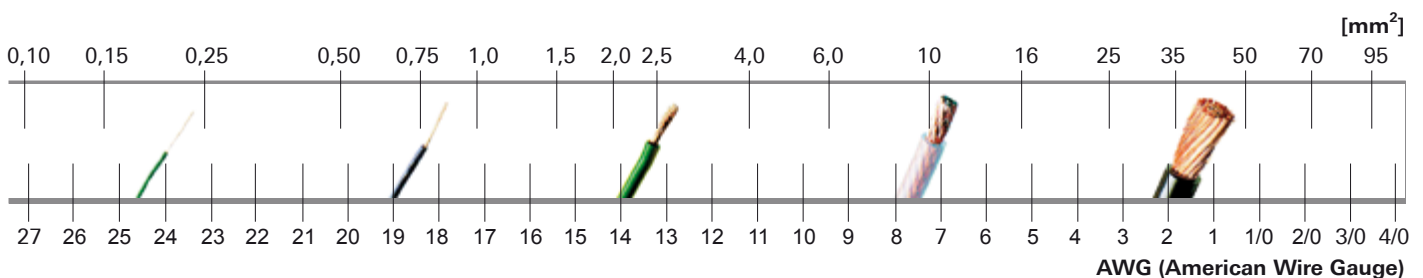

<sup>1)</sup> Der Grafik liegen Werte für Litzen aus UL 758 "UL Standard for Safety for Appliance Wiring Material" zugrunde.

<sup>1)</sup> The chart is based on values for stranded wires given in UL 758 "UL Standard for Safety for Appliance Wiring Material".

## Index

Typ Type	Seite Page
FLEX-SOL-XL 2,5	47
FLEX-SOL-XL 4,0	47
FLEX-SOL-XL 6,0	47
FLEX-SOL-XL 10	47
MC-K2,5BE/PV-PLS-BII/-/...	19
MC-K2,5BE/PV-PLS-BII/PV-PLS-SII/...	19
MC-K2,5BE/PV-PLS-SII/-/...	19
MC-K2,5BY/PV-PLS-BII/-/...	19
MC-K2,5BY/PV-PLS-BII/PV-PLS-SII/...	19
MC-K2,5BY/PV-PLS-SII/-/...	19
MC-K2,5SXL/PV-KBT3II/-/...	66
MC-K2,5SXL/PV-KBT4I/-/...	66
MC-K2,5SXL/PV-KST3II/-/...	66
MC-K2,5SXL/PV-KST4I/-/...	66
MC-K2,5SXL/PV-PLS-BI/-/...	19
MC-K2,5SXL/PV-PLS-BI/PV-PLS-SI/...	19
MC-K2,5SXL/PV-PLS-SI/-/...	19
MC-K4BE/PV-PLS-BIII/-/...	19
MC-K4BE/PV-PLS-BIII/PV-PLS-SIII/...	19
MC-K4BE/PV-PLS-SIII/-/...	19
MC-K4BY/PV-PLS-BIII/-/...	19
MC-K4BY/PV-PLS-BIII/PV-PLS-SIII/...	19
MC-K4BY/PV-PLS-SIII/-/...	19
MC-K4SXL/PV-KBT3II/-/...	66
MC-K4SXL/PV-KBT4I/-/...	66
MC-K4SXL/PV-KST3II/-/...	66
MC-K4SXL/PV-KST4I/-/...	66
MC-K4SXL/PV-PLS-BII/-/...	19
MC-K4SXL/PV-PLS-BII/PV-PLS-SII/...	19
MC-K4SXL/PV-PLS-SII/-/...	19
MC-K6BE/PV-PLS-BIII/-/...	19
MC-K6BE/PV-PLS-BIII/PV-PLS-SIII/...	19
MC-K6BE/PV-PLS-SIII/-/...	19
MC-K6BY/PV-PLS-BIII/-/...	19
MC-K6BY/PV-PLS-BIII/PV-PLS-SIII/...	19
MC-K6BY/PV-PLS-SIII/-/...	19
MC-K6SXL/PV-KBT3/6III/-/...	66
MC-K6SXL/PV-KBT4II/-/...	66
MC-K6SXL/PV-KST3/6III/-/...	66
MC-K6SXL/PV-KST4II/-/...	66
MC-K6SXL/PV-PLS-BIII/-/...	19
MC-K6SXL/PV-PLS-BIII/PV-PLS-SIII/...	19
MC-K6SXL/PV-PLS-SIII/-/...	19
MC-K10SXL/PV-KBT3IV/-/...	66

## Index

Typ Type	Seite Page
MC-K10SXL/PV-KBT4II/-/...	66
MC-K10SXL/PV-KST3IV/-/...	66
MC-K10SXL/PV-KST4II/-/...	66
PV-ADBP3/6/GWD	21
PV-ADBP3/GWD	21
PV-ADBP4-S2/2,5	23, 25
PV-ADBP4-S2/6	23, 25
PV-ADSP3/6/GWD	21
PV-ADSP3/GWD	21
PV-ADSP4-S2/2,5	23, 25
PV-ADSP4-S2/6	23, 25
PV-A-KBT3/KST4	51
PV-A-KBT4/KST3	51
PV-AMLB3/150	50
PV-AMLB4/150	50
PV-AMLS3/150	50
PV-AMLS4/150	50
PV-AWZ3	59
PV-AWZ3-KK	59
PV-AWZ3-ML	59
PV-AZB3-UR	27
PV-AZB4	29
PV-AZM-156	56, 63
PV-AZM-410	56, 63
PV-AZS3-UR	27
PV-AZS4	29
PV-BVK3	54
PV-BVK3-OL	54
PV-BVK4	55
PV-CZ	57
PV-CZM-16100A	57
PV-CZM-17100	57
PV-CZM-18100	57
PV-CZM-19100	57, 63
PV-CZM-20100	57
PV-CZM-21100	57
PV-DE/LP-45V/8A	45
PV-ES-CZM-16100	57
PV-ES-CZM-17100	57
PV-ES-CZM-18100	57
PV-ES-CZM-19100	57
PV-ES-CZM-20100	57
PV-ES-CZM-21100	57
PV-JB-LC-2/2,5BE	41

Typ Type	Seite Page	Typ Type	Seite Page
PV-JB-LC-2/2,5BE/KF	41	PV-KST3/6IIA	13
PV-JB-LC-2/2,5SXL	41	PV-KST3/6III-UR	13
PV-JB-LC-2/2,5SXL/KF	41	PV-KST3III-UR	13
PV-JB-LC-2/N2,5BE	41	PV-KST3II-UR	13
PV-JB-LC-2/N2,5BE/KF	41	PV-KST3I-UR	13
PV-JB-LC-2/N2,5SXL	41	PV-KST3IV	13
PV-JB-LC-2/N2,5SXL/KF	41	PV-KST3-P AU	52
PV-JB-LC/SP/N2,5BE/KF	43	PV-KST4/2,5II-UR	15, 17
PV-JB-LC/SP/N2,5SXL/KF	43	PV-KST4/2,5I-UR	15, 17
PV-JB/LP/N4RS/...	45	PV-KST4/6II-UR	15, 17
PV-JB/LP/N4RS/...+DE/LP/45V/8A	45	PV-KST4/6I-UR	15, 17
PV-JB/WL-H-01-A-C	35	PV-KST4/10II	15, 17
PV-JB/WL-H-01-A-WS	35	PV-KST4II-P AU	52
PV-JB/WL-H-01-B-C	35	PV-LOC	57
PV-JB/WL-H-01-B-WS	35	PV-LOC-A	57
PV-JB/WL-H-01-C-C	35	PV-LOC-A10	57
PV-JB/WL-H-01-C-WS	35	PV-M-AZM-156	56
PV-JB/WL-V-01-A-C	37	PV-M-AZM-410	56
PV-JB/WL-V-01-A-WS	37	PV-MS	61, 63
PV-JB/WL-V-01-B-C	37	PV-MS-PLS	61
PV-JB/WL-V-01-B-WS	37	PV-PST	53
PV-JB/WL-V-01-C-C	37	PV-R-RWZ3	58
PV-JB/WL-V-01-C-WS	37	PV-RWZ3	58, 62
PV-K/BC...	49, 64	PV-SSE-AD4	60, 63
PV-KBT3/6IIA	13	PV-SSH4	53
PV-KBT3/6III-UR	13	PV-SVK3	54
PV-KBT3III-UR	13	PV-SVK3-OL	54
PV-KBT3II-UR	13	PV-SVK4	55
PV-KBT3I-UR	13	PV-WZ3-SET	62
PV-KBT3IV	13	PV-WZ4-SET	63
PV-KBT3-P AU	52	PV-WZ-AD/GWD	60, 63
PV-KBT4/2,5II-UR	15, 17	PV-WZ-JB/LC	41
PV-KBT4/2,5I-UR	15, 17	PV-WZ-JB/LC/SP	43
PV-KBT4/6II-UR	15, 17		
PV-KBT4/6I-UR	15, 17		
PV-KBT4/10II	15, 17		
PV-KBT4II-P AU	52		
PV-KH/LC	41, 43		
PV-KH/LC II	41, 43		
PV-KO 2,5-4	59		
PV-KO3 I+II	58		
PV-KO3 III	58		
PV-KO 6	59		
PV-KO 10	59		

**Headquarters:****Multi-Contact AG**

Stockbrunnenrain 8  
CH – 4123 Allschwil  
Tel. +41/61/306 55 55  
Fax +41/61/306 55 56  
mail [basel@multi-contact.com](mailto:basel@multi-contact.com)  
[www.multi-contact.com](http://www.multi-contact.com)

**Multi-Contact Deutschland GmbH**

Hegenheimer Straße 19  
Postfach 1606  
DE – 79551 Weil am Rhein  
Tel. +49/76 21/6 67 - 0  
Fax +49/76 21/6 67 - 100  
mail [weil@multi-contact.com](mailto:weil@multi-contact.com)

**Multi-Contact Essen GmbH**

Westendstraße 10  
Postfach 10 25 27  
DE – 45025 Essen  
Tel. +49/2 01/8 31 05 - 0  
Fax +49/2 01/8 31 05 - 99  
mail [essen@multi-contact.com](mailto:essen@multi-contact.com)

**Multi-Contact France SAS**

4 rue de l'Industrie  
BP 37  
FR – 68221 Héisingue Cedex  
Tel. +33/3/89 67 65 70  
Fax +33/3/89 69 27 96  
mail [france@multi-contact.com](mailto:france@multi-contact.com)

**Multi-Contact USA**

100 Market Street  
US – Windsor, CA 95492  
Tel. +1/707/838 - 0530  
Fax +1/707/838 - 2474  
mail [usa@multi-contact.com](mailto:usa@multi-contact.com)  
[www.multi-contact-usa.com](http://www.multi-contact-usa.com)

**Multi-Contact****Handelsges.m.b.H. Austria**

Hauptplatz 3b  
AT – 3452 Heiligeneich  
Tel. +43/2275/56 56  
Fax +43/2275/56 56 4  
mail [austria@multi-contact.com](mailto:austria@multi-contact.com)

**Multi-Contact Benelux  
c/o Stäubli Benelux N.V.**

Meensesteenweg 407  
BE – 8501 Bissegem  
Tel. +32/56 36 41 00  
Fax +32/56 36 41 10  
mail [benelux@multi-contact.com](mailto:benelux@multi-contact.com)

**Multi-Contact Czech  
c/o Stäubli Systems, s.r.o.**

Hradecká 536  
CZ – 53009 Pardubice  
Tel. +420/466/616 126  
Fax +420/466/616 127  
mail [connectors.cz@staubli.com](mailto:connectors.cz@staubli.com)

**Multi-Contact Española  
c/o Stäubli Española S.A.**

C/Reina Elionor 178, 1º  
ES – 08205 Sabadell  
Tel. +34/93/720 65 50  
Fax +34/93/712 42 56  
mail [spain@multi-contact.com](mailto:spain@multi-contact.com)

**Multi-Contact (UK) Ltd.**

Multi-Contact House  
Presley Way, Crownhill, Milton Keynes  
GB – Buckinghamshire MK8 0ES  
Tel. +44/1908 26 55 44  
Fax +44/1908 26 20 80  
mail [uk@multi-contact.com](mailto:uk@multi-contact.com)

**Multi-Contact Italia**

**c/o Stäubli Italia S.p.A.**  
Via Rivera, 55  
IT – 20841 Carate Brianza (MB)  
Tel. +39/0362/94 45 01  
Fax +39/0362/94 43 82  
mail [italy@multi-contact.com](mailto:italy@multi-contact.com)

**Multi-Contact Portugal  
c/o Stäubli Portugal**

Representações Lda  
Via Central de Milheirós, 171-A  
PT – 4475-330 Milheirós/Maia  
Tel. +351/229 783 956  
Fax +351/229 783 959  
mail [portugal@multi-contact.com](mailto:portugal@multi-contact.com)

**Multi-Contact Türkiye  
c/o Stäubli Sanayi Makine ve**

Aksesuarları Ticaret Ltd. Şti.  
Atatürk Mahallesi, Marmara  
Sanayi Sitesi, B Blok No: 28 İkitelli  
TR – 34306 İstanbul  
Tel. +90/212/472 13 00  
Fax +90/212/472 12 30  
mail [turkey@multi-contact.com](mailto:turkey@multi-contact.com)

**Multi-Contact Russia  
OOO STAUBLI RUS**

ul.Startovaya 8a  
RU – 196210 Saint Petersburg  
Tel. + 7 812 334 46 30  
Fax + 7 812 334 46 36  
mail [russia@multi-contact.com](mailto:russia@multi-contact.com)  
[www.multi-contact-russia.ru](http://www.multi-contact-russia.ru)

**Multi-Contact Brazil**

**c/o Stäubli Comércio, Importação,  
Exportação e Representações Ltda.**  
Rua Henri Dunant, 137 - Conj. D  
BR – 04709-110 São Paulo  
Tel. +55/11/2348 7400  
Fax +55/11/5181 8334  
mail [brazil@multi-contact.com](mailto:brazil@multi-contact.com)

**Multi-Contact China  
c/o Stäubli Mechatronic Co., Ltd.**

Hangzhou Economic and  
Technological Development Zone  
No. 123 Weiken Street  
CN – 310018 Hangzhou  
Tel. +86/400 66 700 66  
Fax +86/571/86 91 25 22  
mail [hangzhou@staubli.com](mailto:hangzhou@staubli.com)

**Multi-Contact Hongkong  
c/o Stäubli (H.K.) Ltd.**

Unit 87, 12/F, HITEC  
No. 1 Trademart Drive  
Kowloon Bay  
HK – Hong Kong  
Tel. +852/2366 0660  
Fax +852/2311 4677  
mail [connectors.hk@staubli.com](mailto:connectors.hk@staubli.com)

**Multi-Contact Taiwan  
c/o Stäubli (H.K.) Ltd.  
Taiwan Branch**

6/F-3, No. 21, Lane 583  
Ruiguang Road, Neihu Dist.  
TW – Taipei City 11466  
Tel. +886/2/8797 7795  
Fax +886/2/8797 8895  
mail [connectors.tw@staubli.com](mailto:connectors.tw@staubli.com)

**Multi-Contact India**

**c/o Stäubli Tec Systems India Pvt Ltd**  
Stäubli House  
Plot No° 55, Road No° 15 / 17  
M.I.D.C. Industrial Area Andheri (East)  
IND – 400093 Mumbai  
Tel. +91/22/282 39 343 - 345  
Fax +91/22/282 35 484  
mail [india@multi-contact.com](mailto:india@multi-contact.com)

**Multi-Contact Korea  
c/o Stäubli Korea Co., Ltd.**

2F, DCCI, 107-2,  
Shincheon-dong, Dong-gu,  
ROK – 701-702 Daegu  
Tel. +82/53/753/0075  
Fax +82/53/753/0072  
mail [korea@multi-contact.com](mailto:korea@multi-contact.com)

**Multi-Contact  
(South East Asia) Pte. Ltd.**

215 Henderson Road #01-02  
Henderson Industrial Park  
SG – Singapore 159554  
Tel. +65/626 609 00  
Fax +65/626 610 66  
mail [singapore@multi-contact.com](mailto:singapore@multi-contact.com)

**Multi-Contact (Thailand) Co., Ltd.**

160/865-866 Silom Road  
ITF-Silom Palace 33<sup>rd</sup> Floor  
Suriyawong, Bangrak  
TH – Bangkok 10500  
Tel. +66/2/266 78 79; 268 08 04  
Fax +66/2/267 76 80  
mail [thailand@multi-contact.com](mailto:thailand@multi-contact.com)

Ihre Multi-Contact Vertretung:  
Your Multi-Contact representative:



Sie finden Ihren Ansprechpartner unter  
You will find your local partner at

## X-ON Electronics

Largest Supplier of Electrical and Electronic Components

*Click to view similar products for [multi-contact manufacturer](#):*

Other Similar products are found below :

[23.3070-21,+ -22,+ -23,+ -24,+ -25](#) [60.7190-24](#) [60.7453-21](#) [659179-100-21](#) [66.9394-150-21](#) [66.9426-150-21](#) [66.9516-22](#) [66.9706-21](#)  
[67.9762-21](#) [15.0084-21](#) [14.0048C3-28](#) [32.0017P0001](#) [66.9393-100-21](#) [23.0050-25](#) [61.7607-21 25M](#) [60.7265-22 5M](#) [60.7200-25](#) [60.7001-24](#)  
[60.7030-22 5M](#) [60.7265-21 25M](#) [61.7607-29 25M](#) [61.7613-21](#) [23.3160-22](#) [67.9799-22](#) [64.9214-2122](#) [60.7003-21](#) [20066-1](#) [61.7615-33](#)  
[TRANS](#) [23.0050-21](#) [66.9829-22](#) [28.0055-100-22](#) [66.9394-150-22](#) [65.3314-21,+ -22,+ -23,+ -24,+ -25,+ -29](#) [23.3060-23](#) [61.7613-23](#) [60.7030-](#)  
[24 25M](#) [60.7033-22 25M](#) [60.7180-25](#) [61.7610-21](#) [63.9356-21](#) [65.3300-21 + 65.3300-22](#) [23.3070-22](#) [60.7003-23](#) [60.7180-24](#) [23.0410-22](#)  
[66.9649-22](#) [24.0157-4](#) [60.7030-21 5M](#) [60.7003-22](#) [60.7180-29](#)