

FEATURES

- SHIELDED POWER INDUCTOR
- HIGH CURRENT, SMALL SIZE (UP TO 7 AMPS)
- SURFACE MOUNTABLE CONSTRUCTION
- HIGH INDUCTANCE (UP TO 10,000 μ H)
- TAPED AND REELED FOR AUTOMATIC INSERTION
- FOR USE IN DC/DC CONVERTERS

RoHS
Compliant
includes all homogeneous materials

*See Part Number System for Details



CHARACTERISTICS

Case Size	NPIS16R	NPIS31R	NPIS52R
Inductance Range	1 ~ 10000 μ H	1.0 ~ 390 μ H	10 ~ 1000 μ H
Ambient Operating Temperature Range	-40°C ~ +125°C		
Maximum Component Temperature (Ambient + Self-Heating)	+155°C	+155°C	
Temperature Rise at Irms	+30°C max.	+40°C max.	
Inductance Change at Isat	-30% typical (NPIS16R), -10% typical (All Other Case Sizes)		
Inductance Tolerance	20% (M), \pm 30% (Y)		
Resistance to Solder Heat	260°C for 10 seconds		

DIMENSIONS (mm)

Series	A	B	C	D	E	F	G	H	I
NPIS16R	4.45 Max	6.6 Max	2.92 Max	1.02 \pm 0.2	1.27 \pm 0.2	4.32 \pm 0.3	4.06	3.56	1.4
NPIS31R	10.0 \pm 0.2	12.7 \pm 0.2	5.0 \pm 0.3	2.4 \pm 0.2	2.2 \pm 0.2	7.6 \pm 0.3	7.3	2.8	3.0
NPIS52R	15.0 \pm 0.3	18.4 \pm 0.3	7.0 \pm 0.5	2.4 \pm 0.2	2.2 \pm 0.2	13.3 \pm 0.3	12.7	2.8	3.0

NPIS16R

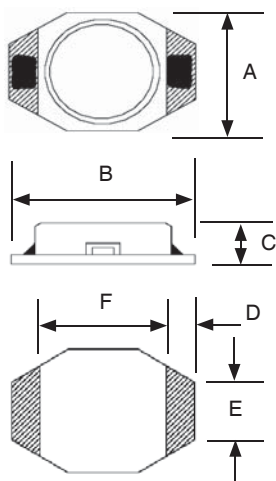

NPIS31R AND 52R

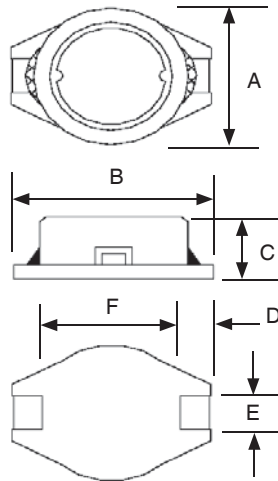

REFLOW SOLDERING PROFILE

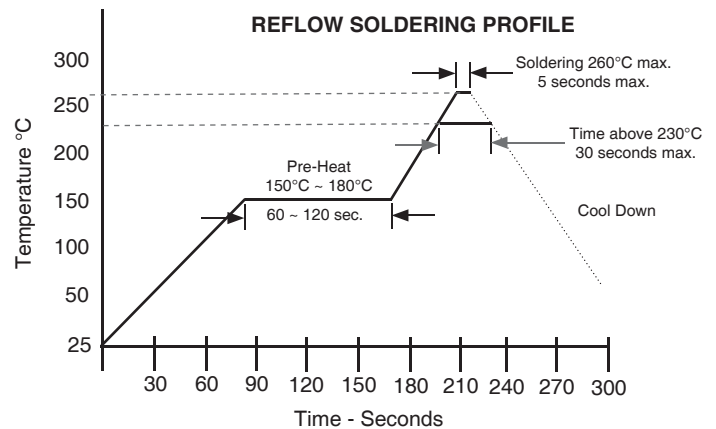

LAND PATTERN

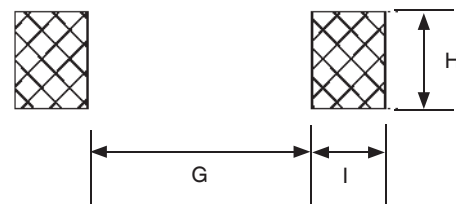

Part Number	STANDARD VALUES - CASE SIZE 16 (4.45 x 6.6 x 2.92mm)				
	Inductance Value (μH)	SRF (Typical) MHz	DC Resistance (Ω)	DC Current Isat/Irms (Amps)	Test Frequency
NPIS16R1R0MTRF	1.0±20%	250	0.040	3.0	100KHz
NPIS16R1R5MTRF	1.5±20%	125	0.045	2.3	
NPIS16R2R2MTRF	2.2±20%	120	0.050	1.8	
NPIS16R3R3MTRF	3.3±20%	120	0.055	1.6	
NPIS16R4R7MTRF	4.7±20%	105	0.060	1.4	
NPIS16R6R8MTRF	6.8±20%	50	0.065	1.2	
NPIS16R100MTRF	10±20%	38	0.075	1.0	
NPIS16R150MTRF	15±20%	33	0.090	0.80	
NPIS16R220MTRF	22±20%	25	0.110	0.70	
NPIS16R330MTRF	33±20%	20	0.190	0.60	
NPIS16R470MTRF	47±20%	20	0.230	0.50	
NPIS16R680MTRF	68±20%	15	0.290	0.40	
NPIS16R101MTRF	100±20%	10	0.480	0.30	
NPIS16R151MTRF	150±20%	9.0	0.590	0.26	
NPIS16R221MTRF	220±20%	6.0	0.770	0.22	
NPIS16R331MTRF	330±20%	5.0	1.40	0.20	
NPIS16R471MTRF	470±20%	4.0	1.80	0.19	
NPIS16R681MTRF	680±20%	3.0	2.20	0.16	
NPIS16R102MTRF	1000±20%	2.0	3.40	0.15	
NPIS16R152MTRF	1500±20%	2.0	4.20	0.12	
NPIS16R222MTRF	2200±20%	2.0	8.50	0.10	
NPIS16R332MTRF	3300±20%	1.0	11.0	0.08	
NPIS16R472MTRF	4700±20%	1.0	13.9	0.06	
NPIS16R682MTRF	6800±20%	1.0	25.0	0.04	
NPIS16R103MTRF	10000±20%	0.8	32.8	0.02	

Maximum +30°C temperature rise at Irms. Typical -30% inductance change at Isat.

PART NUMBER SYSTEM

NPIS 16 R 102 K TR F

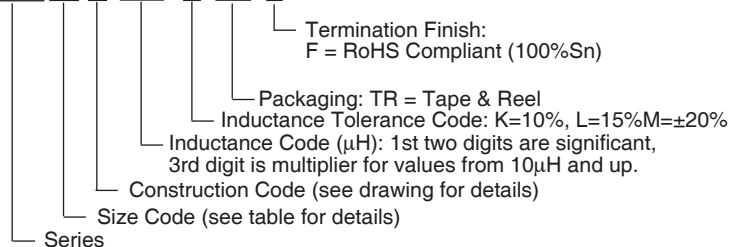

Part Number	STANDARD VALUES - CASE SIZE 31 (10.0 x 12.7 x 5.0mm)					Test Frequency
	Inductance Value (µH)	SRF (Typical) MHz	DC Resistance (Ω)	DC Current Irms (Amps)	DC Current Isat (Amps)	
NPIS31R1R0YTRF	1.0 ± 30%	130	0.021	5.00	5.6	100KHz
NPIS31R1R5YTRF	1.5 ± 30%	110	0.022	4.50	5.2	
NPIS31R2R2YTRF	2.2 ± 30%	90	0.027	3.10	5.0	
NPIS31R3R0YTRF	3.0 ± 30%	65	0.030	2.90	3.9	
NPIS31R4R7YTRF	4.7 ± 30%	50	0.040	2.50	3.2	
NPIS31R6R8YTRF	6.8 ± 30%	30	0.055	2.20	2.8	
NPIS31R100MTRF	10 ± 20%	28	0.065	2.00	2.4	
NPIS31R120MTRF	12 ± 20%	25	0.080	1.80	2.2	
NPIS31R150MTRF	15 ± 20%	20	0.085	1.70	2.0	
NPIS31R180MTRF	18 ± 20%	19	0.090	1.60	1.8	
NPIS31R220MTRF	22 ± 20%	18	0.100	1.40	1.6	
NPIS31R270MTRF	27 ± 20%	16	0.120	1.30	1.5	
NPIS31R330MTRF	33 ± 20%	14	0.160	1.20	1.4	
NPIS31R390MTRF	39 ± 20%	12	0.180	1.05	1.2	
NPIS31R470MTRF	47 ± 20%	11	0.190	1.00	1.0	
NPIS31R560MTRF	56 ± 20%	10	0.210	0.90	0.95	
NPIS31R680MTRF	68 ± 20%	9.0	0.340	0.82	0.90	
NPIS31R820MTRF	82 ± 20%	8.0	0.380	0.75	0.85	
NPIS31R101MTRF	100 ± 20%	7.5	0.420	0.68	0.80	
NPIS31R121MTRF	120 ± 20%	7.0	0.460	0.60	0.70	
NPIS31R151MTRF	150 ± 20%	6.3	0.520	0.55	0.60	
NPIS31R181MTRF	180 ± 20%	5.5	0.700	0.50	0.65	
NPIS31R221MTRF	220 ± 20%	5.0	0.800	0.45	0.50	
NPIS31R271MTRF	270 ± 20%	4.5	1.10	0.40	0.45	
NPIS31R331MTRF	330 ± 20%	4.0	1.20	0.35	0.40	
NPIS31R391MTRF	390 ± 20%	3.3	1.40	0.33	0.35	

Maximum +40°C temperature rise at Irms. Typical -10% inductance change at Isat.

Part Number	STANDARD VALUES - CASE SIZE 52 (15.0 x 18.4 x 7.0mm)					Test Frequency
	Inductance Value (µH)	SRF (Typical) MHz	DC Resistance (Ω)	DC Current Irms (Amps)	DC Current Isat (Amps)	
NPIS52R100MTRF	10 ± 20%	20	0.030	4.00	7.0	100KHz
NPIS52R150MTRF	15 ± 20%	17	0.035	3.60	6.2	
NPIS52R220MTRF	22 ± 20%	15	0.045	3.15	5.0	
NPIS52R330MTRF	33 ± 20%	10	0.060	2.80	4.2	
NPIS52R470MTRF	47 ± 20%	8.5	0.080	2.45	3.5	
NPIS52R680MTRF	68 ± 20%	6.5	0.115	2.00	3.0	
NPIS52R101MTRF	100 ± 20%	5.5	0.180	1.70	2.4	
NPIS52R151MTRF	150 ± 20%	5.0	0.220	1.35	2.0	
NPIS52R221MTRF	220 ± +0%	4.0	0.320	1.15	1.6	
NPIS52R331MTRF	330 ± 20%	3.0	0.500	0.90	1.3	
NPIS52R471MTRF	470 ± 20%	2.5	0.750	0.75	1.1	
NPIS52R681MTRF	680 ± 20%	2.3	1.10	0.65	0.90	
NPIS52R102MTRF	1000 ± 20%	1.9	1.50	0.55	0.75	

Maximum +40°C temperature rise at Irms. Typical -10% inductance change at Isat.



Case Size	TAPE DIMENSIONS					
	Ao	Bo	Ko	Co	W	Po
NPIS16R	6.7	4.6	3.2	4.25	12.0	8.0
NPIS31R	13.2	9.5	5.4	10.25	24.0	12.0
NPIS52R	18.7	15.4	7.3	14.25	32.0	20.0

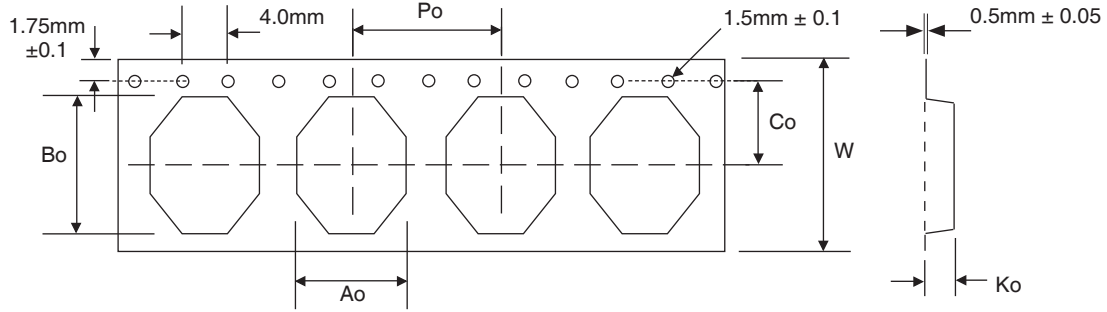

Tape Width	REEL DIMENSIONS (mm)			
	A(mm)	B(mm)	C(mm)	D(mm)
24mm	24.5±0.1	100±1	13±0.5	330
32mm	32.5±0.1			

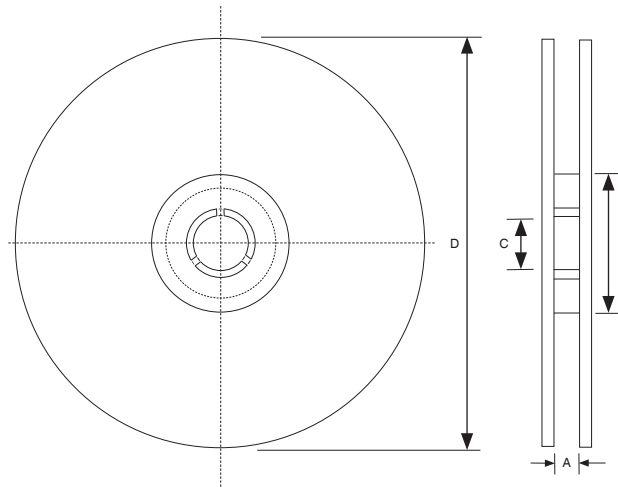

Size	REEL QUANTITY PER CASE SIZE				
	NPIS16R	NPIS22R	NPIS30R	NPIS31R	NPIS52R
Quantity per reel	2500	1000	1000	500	250
Tape Width	16mm	24mm	24mm	24mm	32mm



X-ON Electronics

Largest Supplier of Electrical and Electronic Components

Click to view similar products for [Fixed Inductors](#) category:

Click to view products by [NIC](#) manufacturer:

Other Similar products are found below :

[MLZ1608M6R8WTD25](#) [MLZ1608N6R8LT000](#) [MLZ1608N3R3LTD25](#) [MLZ1608N3R3LT000](#) [MLZ1608N150LT000](#)

[MLZ1608M150WTD25](#) [MLZ1608M3R3WTD25](#) [MLZ1608M3R3WT000](#) [MLZ1608M150WT000](#) [MLZ1608A1R5WT000](#)

[MLZ1608N1R5LT000](#) [B82432C1333K000](#) [PCMB053T-1R0MS](#) [PCMB053T-1R5MS](#) [PCMB104T-1R5MS](#) [CR32NP-100KC](#) [CR32NP-](#)

[151KC](#) [CR32NP-180KC](#) [CR32NP-181KC](#) [CR32NP-1R5MC](#) [CR32NP-390KC](#) [CR32NP-3R9MC](#) [CR32NP-680KC](#) [CR32NP-820KC](#)

[CR32NP-8R2MC](#) [CR43NP-390KC](#) [CR43NP-560KC](#) [CR43NP-680KC](#) [CR54NP-181KC](#) [CR54NP-470LC](#) [CR54NP-820KC](#) [CR54NP-8R5MC](#)

[MGDQ4-00004-P](#) [MGDU1-00016-P](#) [MHL1ECTTP18NJ](#) [MHL1JCTTD12NJ](#) [PE-51506NL](#) [PE-53601NL](#) [PE-53630NL](#) [PE-53824SNLT](#) [PE-](#)

[62892NL](#) [PE-92100NL](#) [PG0434.801NLT](#) [PG0936.113NLT](#) [PM06-2N7](#) [PM06-39NJ](#) [HC2LP-R47-R](#) [HC2-R47-R](#) [HC3-2R2-R](#) [HC8-1R2-R](#)