

Precision 0.1% and 0.5%, tolerance  
Thin Film Chip Resistor

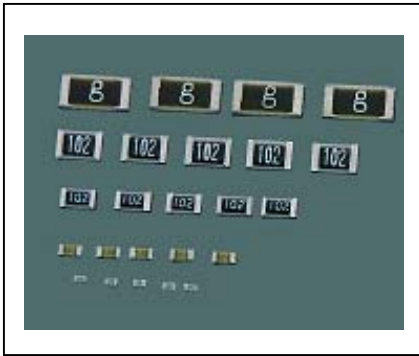

**FEATURES**

- Excellent low noise, THIN FILM(NiCr) construction
- Low temperature coefficient and tight tolerance
- EIA standard case size(0201, 0402, 0603, 0805)
- RoHS Compliance and 100% Lead-Free (Matte Sn termination finished)

**APPLICATIONS**

- Telecommunications
- Test & Measurement
- Power Supplies
- Computer & Peripherals

**Electrical Specification**

Type	Size	Power Rating at 70 °C	Resistance Tolerance (Code)	Resistance Range (ohm)	Temperature Coefficient (Code)		Max. operating Voltage	Resistance Values (E-series)
					(ohm)	(ppm/°C)		
RR0306	0201	0.050W	±1.0% (F)	10-22K	10-30	100(R)	15V	E-24
			±0.5% (D)		33-22K	25(P)		
RR0510	0402	0.063W	±0.5% (D)	10-100K	10-97.6	100(R)	25V	E-24, E-96
					100-100K	25(P)		
RR0816	0603	0.063W	±0.5% (D)	10-360K	10-97.6	50(Q)	75V	E-24, E-96
			±0.1% (B)	100-332K	100-332K	25(P)		
RR1220	0805	0.100W	±0.5% (D)	10-1M	10-97.6	50(Q)	100V	E-24, E-96
			±0.1% (B)	100-1M	100-1M	25(P)		
RR1632	1206	0.125W	±0.5% (D)	10-1M	10-49.9	50(Q)	150V	E-24, E-96
			±0.1% (B)	100-1M	100-1M	25(P)		
RR2632	1210	0.250W	±0.5% (D)	10-2M	10-49.9	50(Q)	200V	E-24, E-96
			±0.1% (B)	100-2M	51-2M	25(P)		

**Performance**

Item	Test Methode	Performance of Reliability	
		Max	Typical
Short Time Overload	2.5 times of Rated Load X 5sec.	+/- 0.5%	+/- 0.1%
Load Life	70°C Rated Load 90min. On/ 30min. Off per Cycle X1000	+/- 0.5%	+/- 0.1%
Humidity	60°C 95% RH rated voltage loaded 90min. On/ 30min. Off per Cycle X1000	+/- 0.5%	+/- 0.1%
Temp. Cycling	-55°C (30min)/room temp.(2min) / +125°C(30min)/room temp.(2min) No Load per Cycle X1000	+/- 0.5%	+/- 0.1%
High Temperature	125°C No Load 1000h	+/- 0.5%	+/- 0.1%

**Precision 0.1% and 0.5%, tolerance  
Thin Film Chip Resistor**

**Dimensions & Footprints**

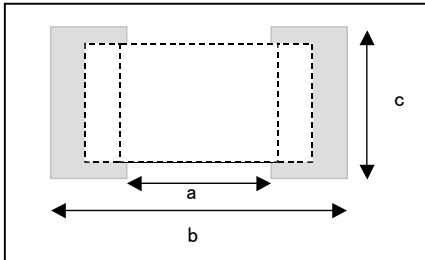
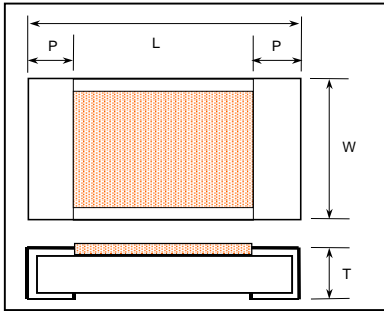

	Dimensions inch (mm)			
	L	W	P	T
RR0306	.024±.002 (0.6 ± 0.05)	.012±.002 (0.3 ± 0.05)	.005±.002 (0.12 ± 0.05)	.009±.002 (0.23 ± 0.05)
RR0510	.040±.002 (1.0 ± 0.05)	.020±.002 (0.5 ± 0.05)	.008±.004 (0.2 ± 0.1)	.014±.002 (0.35 ± 0.05)
RR0816	.063 ± .008 (1.6 ± 0.2)	.031 ± .008 (0.8 ± 0.2)	.012 ± .008 (0.3 ± 0.2)	0.016 ± .004 (0.4 ± 0.1)
RR1220	.079 ± .008 (2.0 ± 0.2)	.049 ± .008 (1.25 ± 0.2)	.016 ± .008 (0.4 ± 0.2)	0.016 ± .004 (0.4 ± 0.1)
RR1632	.126 ± .008 (3.2 ± 0.2)	.063 ± .008 (1.6 ± 0.2)	.02 ± .01 (0.5 ± 0.25)	0.016 ± .004 (0.4 ± 0.1)
RR2632	.126 ± .008 (3.2 ± 0.2)	.10 ± .008 (2.6 ± 0.2)	.02 ± .01 (0.5 ± 0.25)	0.016 ± .004 (0.4 ± 0.1)

	Dimensions (mm)		
	a	b	c
RR0306	0.28	0.76	0.34
RR0510	0.5	1.6	0.6
RR0816	1.0	3.0	1.2
RR1220	1.2	4.0	1.65
RR1632	2.2	5.0	2.0
RR3226	2.2	5.0	3.0

**Power Derating Curve**

For operation above 70degC, power rating must be derated according to the following chart

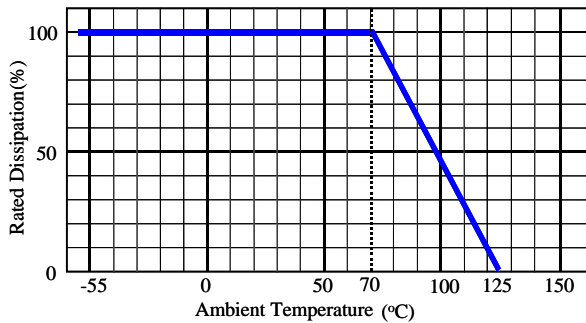

**Recommended Reflow Curve**

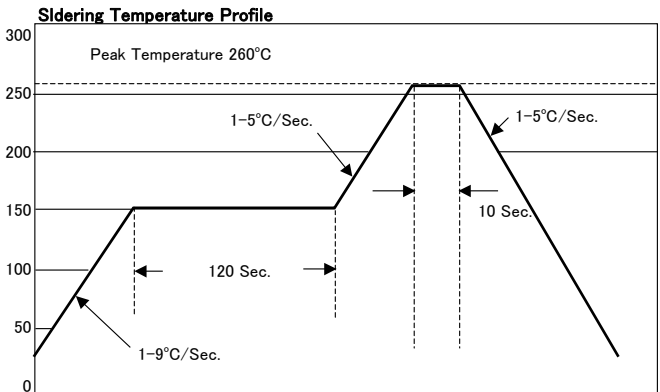

**Tape & Reel Dimensions (mm)**

Type	A	B	E	F	W	P <sub>0</sub>	P <sub>1</sub>	P <sub>2</sub>	t <sub>1</sub>
RR0306	0.38 ± 0.03	0.68 ± 0.03	1.75 ± 0.1	3.5 ± 0.05	8.0 ± 0.3	4.0 ± 0.1	4.0 ± 0.1	2.0 ± 0.05	0.31 ± 0.02
RR0510	0.63 ± 0.05	1.13 ± 0.05							0.43 ± 0.05
RR0816	1.1 ± 0.1	1.9 ± 0.1							0.6 ± 0.05
RR1220	1.65 ± 0.2	2.4 ± 0.2							0.75 ± 0.05
RR1632	1.9 ± 0.1	3.5 ± 0.1							1.0 ± 0.2
RR2632	2.9 ± 0.2	3.6 ± 0.1	5.5 ± 0.05						

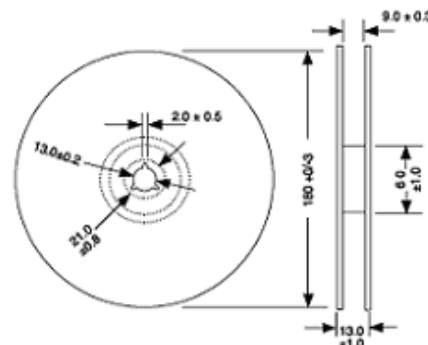
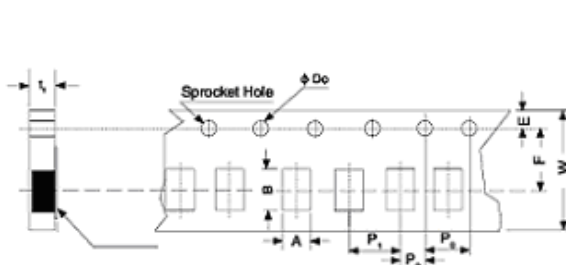

Precision 0.1% and 0.5%, tolerance  
Thin Film Chip Resistor

Ordering information



RR	0816	P	-	104	-	B	-	M	-	T5	-	XXX
TYPE	Size	TCR		R-Values		Tolerance		"M" code		Package		"3" digit code
	0510 0816 1220	P=25ppm/°C		3 digits for E24 series (Ex. 104=100K ohm) 4 digits for E96 series (Ex. 4992=49.9K ohm)		B=0.1%		To be added when E96 series of RR1220		Blank=1000 T5=5000		To be added when E96 series of RR0816 (Ex. 49.9K=68C)

RR	0816	P	-	104	-	D	-	M	-	XXX
TYPE	Size	TCR		R-Values		Tolerance		"M" code		"3" digit code
	0306 0510 0816 1220	P=25ppm/°C Q=50ppm/°C R=100ppm/°C		3 digits for E24 series (Ex. 104=100K ohm) 4 digits for E96 series (Ex. 4992=49.9K ohm)		D=0.5%		To be added when E96 series of RR1220		To be added when E96 series of RR0816 (Ex. 49.9K=68C)

RR	1632	P	-	1002	-	D	-	T1
TYPE	Size	TCR		R-Values		Tolerance		Package
	1632 2632	P=25ppm/°C Q=50ppm/°C		4 digits for all values (Ex. 1003=100K ohm) R=Decimal (Ex. 49R9=49.9 ohm)		B=0.1% D=0.5%		T1=1000 T5=5000

RoHS Compliance and 100% Lead Free information

Our compliance parts will be differentiated by LABEL on the plastic reel.  
Compliant Components: dotted line on the label. (Please see description)

===== RR1220P-1152- B - M - T5 Q.T.Y 5000pcs Inspected f SUSUMU CO.,LTD. Y331704-- K N:   =====	Parts number (Type designation)
	Quantity per reel
	Manufacturing date code
	Identification showing <b>RoHS Compliance &amp; Lead-free</b> (Matte Sn 100%)

Precision 0.1% and 0.5%, tolerance  
Thin Film Chip Resistor

3 digit of resistance code for E96 series

Table 1 shows the first two digits of the three-digit E96 part-marking scheme.

Code	Value	Code	Value	Code	Value	Code	Value	Code	Value	Code	Value
01	100*	17	147	33	215	49	316	65	464	81	681
02	102	18	150*	34	221	50	324	66	475	82	698
03	105	19	154	35	226	51	332	67	487	83	715
04	107	20	158	36	232	52	340	68	499	84	732
05	110*	21	162	37	237	53	348	69	511	85	750*
06	113	22	165	38	243	54	357	70	523	86	768
07	115	23	169	39	249	55	365	71	536	87	787
08	118	24	174	40	255	56	374	72	549	88	806
09	121	25	178	41	261	57	383	73	562	89	825
10	124	26	182	42	267	58	392	74	576	90	845
11	127	27	187	43	274	59	402	75	590	91	866
12	130*	28	191	44	280	60	412	76	604	92	887
13	133	29	196	45	287	61	422	77	619	93	909
14	137	30	200*	46	294	62	432	78	634	94	931
15	140	31	205	47	301	63	442	79	649	95	953
16	143	32	210	48	309	64	453	80	665	96	976

The third character is a letter multiplier:

Code	A	H	C	D	E	F		R	S
Multipliers	10 <sup>0</sup>	10 <sup>1</sup>	10 <sup>2</sup>	10 <sup>3</sup>	10 <sup>4</sup>	10 <sup>5</sup>		10 <sup>-1</sup>	10 <sup>-2</sup>

\* The resistance value duplicated in E24 series and in E96 series shall be manufactured in E24 only

## X-ON Electronics

Largest Supplier of Electrical and Electronic Components

*Click to view similar products for [susumu](#) manufacturer:*

Other Similar products are found below :

[PCMB063T-1R5MS](#) [RG1608NW-1-KIT](#) [RL1220SF-1-KIT](#) [RR0816PD-3-KIT](#) [RR1220PD-4-KIT](#) [PRL1632-R007-F-T1](#) [RR0816PD-1-KIT](#)  
[RR0816PD-4-KIT](#) [RG1608NW-2-KIT](#) [RG1608NW-3-KIT](#) [RR1220PD-3-KIT](#) [RG1608PB-KIT-FILE-E96](#) [KRL1220-KIT-FILE](#) [KRL3216-](#)  
[KIT-FILE](#) [RR1220PD-KIT-FILE](#) [KRL11050-KIT-FILE](#) [KRL1632-KIT-FILE](#) [KRL6432-KIT-FILE](#) [RG1005PB-KIT-FILE](#) [RG2012PB-KIT-](#)  
[FILE](#) [KRL7638-KIT-FILE](#) [RR1220PD-5-KIT](#) [PXV1220S-3DBN2-T02](#) [RG3216P-5103-B-T5](#) [RR0510RD-1-KIT](#) [RG2012P-4643-B-T5](#)  
[RG1608NW-KIT-FILE](#) [RG2012NW-KIT-FILE](#) [RG1608PB-KIT-FILE](#) [KRL9045-KIT-FILE](#) [RR1220P-1241-B-M-T5](#) [RG1005NW-KIT-FILE](#)  
[KRL3264-KIT-FILE](#) [RR0816Q-64R9-D-79R](#) [KRL7638-C-R005-F-T1](#) [RG2012P-4220-B-T5](#) [RR0306PD-1-KIT](#) [RG3216P-2004-B-T1](#)  
[RL3720W-KIT-FILE](#) [RG3216P-8201-D-T5](#) [RG1005PD-KIT](#) [RG1608N-472-W-T1](#) [RG2012P-4321-B-T5](#) [RR0816PD-KIT-FILE](#) [RG1005P-](#)  
[822-B-T5](#) [RG2012PD-KIT-FILE](#) [RG1608P-6192-B-T5](#) [PRL1632-R062-F-T1](#) [HRG3216P-1000-D-T1](#) [RG2012P-751-D-T5](#)