

# PA FAMILY SERIES/PA•PAF•PAL CONNECTOR

2.0mm pitch/Wire-to-board (Crimp style/IDC) / Wire-to-wire (Crimp style/IDC)

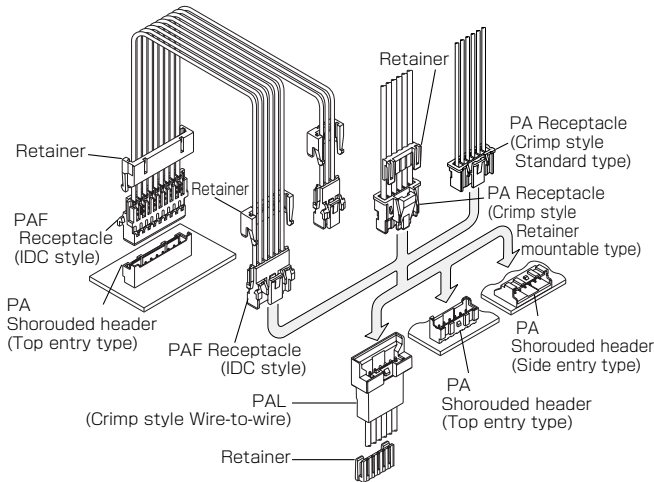

**Based upon wire-to-board crimp style PA connectors, the PA series family of connector have been expanded to meet the requirement of complex wire harness of 2.0 mm pitch connectors with secure locking mechanism thanks to the additional line up of wire-to-board IDC style PAF connectors and wire-to-wire crimp style PAL connectors.**

- **Secure locking device**
- **Interchangeable between crimp and IDC socket**
- **Secondary retainers**
- **Harness variation**

## PA connector (Standard type, Retainer mountable type)

- **Highly reliable contact**
- **Insertion guide mechanism**
- **Flanged press pin**

## PAF connector

- **The industry's first secure lock ID connectors**
- **Metallic strain relief**
- **Retainer with four locking points**

## PAL connector

- **The industry's first wire to wire 2.0 mm pitch retainer mountable type connector.**
- **Either with or without panel lock can be selected according to application.**

## Standards

Recognized E60389

Certified LR20812

## Specifications

### PA Connector (Standard type)

- Current rating: 3 A AC, DC (AWG #22)
- Voltage rating: 250 V AC, DC
- Temperature range: -25°C to +85°C  
(including temperature rise in applying electrical current)
- Contact resistance: Initial value/ 10 mΩ max.  
After environmental tests/ 20 mΩ max.
- Insulation resistance: Initial/ 1,000 MΩ min.
- Withstanding voltage: 800 VAC/minute
- Applicable wire: Conductor size/ AWG #28 to #22  
Insulation O.D./ 0.76 to 1.5 mm
- Applicable PC board thickness: 1.6 mm

### PA Connector (Retainer mountable type)

- Current rating: 3 A AC, DC (AWG #22)
- Voltage rating: 100 V AC, DC
- Temperature range: -25°C to +85°C  
(including temperature rise in applying electrical current)
- Contact resistance: Initial value/ 15 mΩ max.  
After environmental tests/ 25 mΩ max.
- Insulation resistance: Initial/ 1,000 MΩ min.
- Withstanding voltage: 800 V AC/minute
- Applicable wire: AWG #26 to #22

### PAF Connector

- Current rating: 1.0 A AC, DC (AWG #26)
- Voltage rating: 100 V AC, DC
- Temperature range: -25°C to +85°C  
(including temperature rise in applying electrical current)
- Contact resistance: Initial value/ 15 mΩ max.  
After environmental tests/ 25 mΩ max.
- Insulation resistance: Initial/ 1,000 MΩ min.
- Withstanding voltage: 800 VAC/minute
- Applicable wire: UL1061(Contact JST for details regarding other UL wires.)  
AWG #26  
Conductor/ 7 strands, tin-coated annealed copper  
Insulation O.D./ 0.9 to 1.0 mm

### PAL Connector

- Current rating: 3 A AC, DC (AWG #22)
- Voltage rating: 100 V AC, DC
- Temperature range: -25°C to +85°C  
(including temperature rise in applying electrical current)
- Contact resistance: Initial value/ 15 mΩ max.  
After environmental tests/ 25 mΩ max.
- Insulation resistance: Initial/ 1,000 MΩ min.
- Withstanding voltage: 800 VAC/minute
- Applicable wire: AWG #28 to #22
- Applicable panel thickness : 0.5 to 2.0 mm



\* Refer to "General Instruction and Notice when using Terminals and Connectors" at the end of this catalog.

\* Contact JST for details.

\* Compliant with RoHS.

# PA FAMILY SERIES /PA•PAF•PAL CONNECTOR

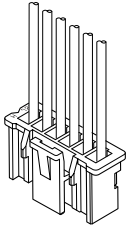
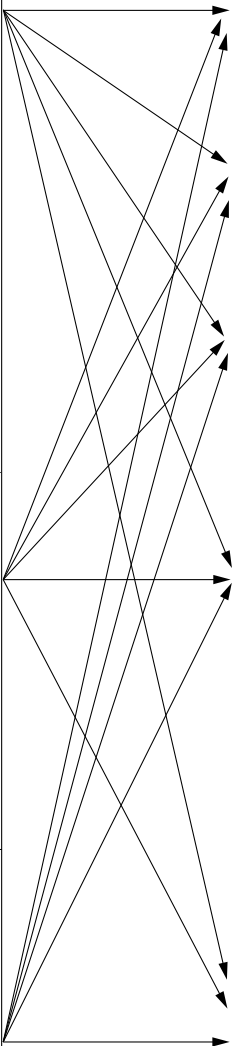
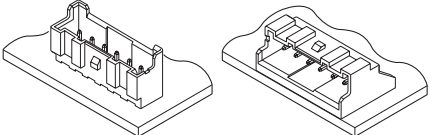
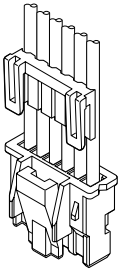
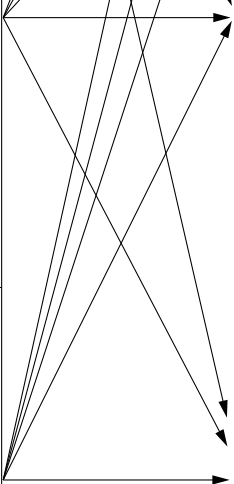
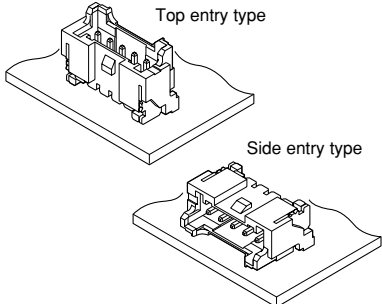
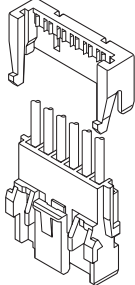
## List of combinations

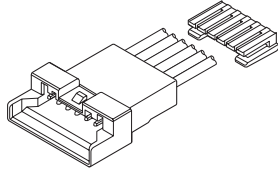
<p><b>Crimp style Standard type</b></p> 	<p><u>Contact</u> SPHD-001T-P0.5 SPHD-002T-P0.5</p> <p><u>Housing</u> PAP-( )V-S</p>		<p><u>Shrouded header</u> B( )B-PASK B( )B-PASK-1 B( )B-PASK-N B( )B-PASK-1N S( )B-PASK-2</p>	<p>Top entry type      Side entry type</p> 
<p><b>Crimp style Retainer mountable type</b></p> 	<p><u>Contact</u> SPA-001T-P0.5</p> <p><u>Housing</u> PARP-( )V</p> <p><u>Retainer</u> PMS-( )V-S</p>		<p><u>Shrouded header</u> BM( )B-PASS BM( )B-PASS-1 SM( )B-PASS SM( )B-PASS-1</p>	<p><b>SMT type</b></p> <p>Top entry type</p> <p>Side entry type</p> 
<p><b>Insulation displacement type</b></p> 	<p><u>Receptacle</u> ( )PAF-6S</p> <p><u>Retainer</u> PAFS-( )V-S</p>		<p><u>Contact</u> SPAL-001T-P0.5 SPAL-002T-P0.5</p> <p><u>Receptacle housing</u> PALR-( )V(F)</p> <p><u>Retainer</u> PMS-( )V-S</p>	<p><b>Wire to wire Connectors</b></p> 

# PA FAMILY SERIES /PA•PAF•PAL CONNECTOR

## PC board layout and Assembly layout

### <Through-hole type>

#### Top entry type

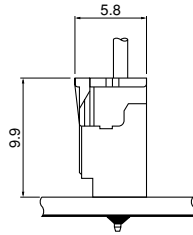
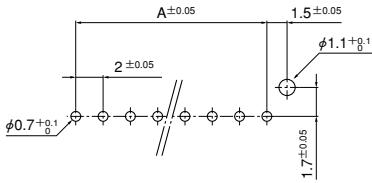

PA Receptacle  
(Standard type)  
+  
PA Header

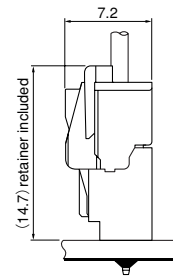

PA Receptacle  
(Retainer mountable type)  
+  
PA Header

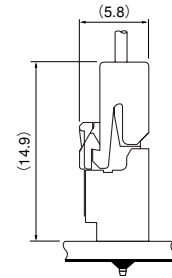

PAF Receptacle  
+  
PA Header

#### Side entry type

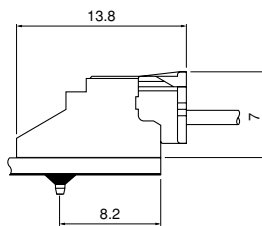
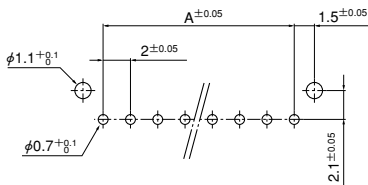

PA Receptacle  
(Standard type)  
+  
PA side entry type header

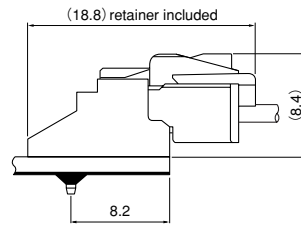

PA Receptacle  
(Retainer mountable type)  
+  
PA side entry type header

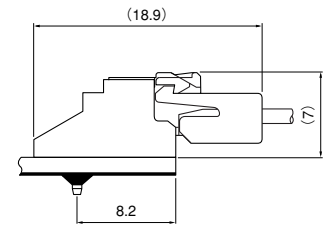

PAF Receptacle  
+  
PA side entry type header

#### Bottom type

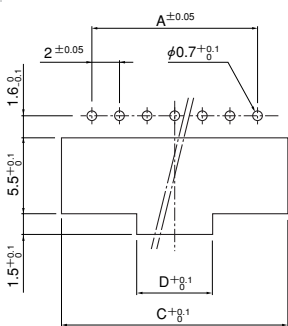

Note: Dimensions C and D; Refer to the header bottom type.

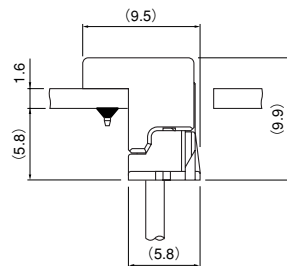

PA Receptacle  
(Standard type)  
+  
PA bottom type header  
(Extended length type)

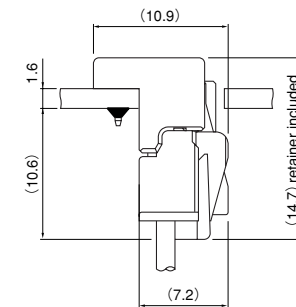

PA Receptacle  
(Retainer mountable type)  
+  
PA bottom type header  
(Extended length type)

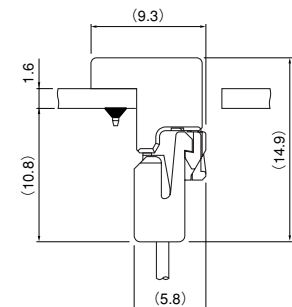

PAF Receptacle  
+  
PA bottom type header  
(Extended length type)

#### Bottom type with extended length

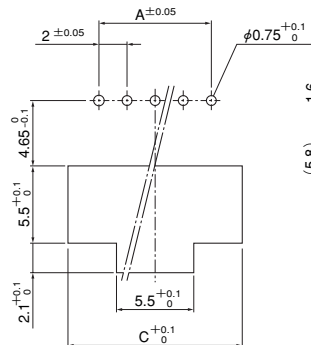

Note: Dimensions C; Refer to the header bottom type.

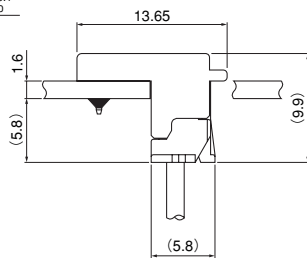

PA Receptacle  
(Standard type)  
+  
PA bottom type header  
(Extended length type)

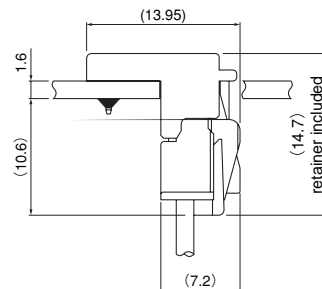

PA Receptacle  
(Retainer mountable type)  
+  
PA bottom type header  
(Extended length type)

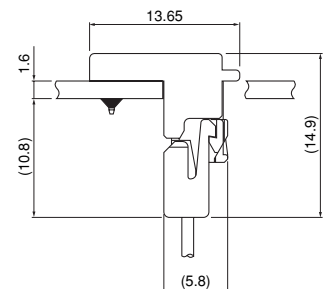

PAF Receptacle  
+  
PA bottom type header  
(Extended length type)

Note: 1. The above figure is the figure viewed from the connector mounting side.

2. Tolerances are non-cumulative: ±0.05 mm for all centers.

3. Hole dimensions differ according to the type of PC board and piercing method. The dimensions above should serve as a guideline. Contact JST for details.

# PA FAMILY SERIES /PA•PAF•PAL CONNECTOR

## PC board layout and Assembly layout

### High box type

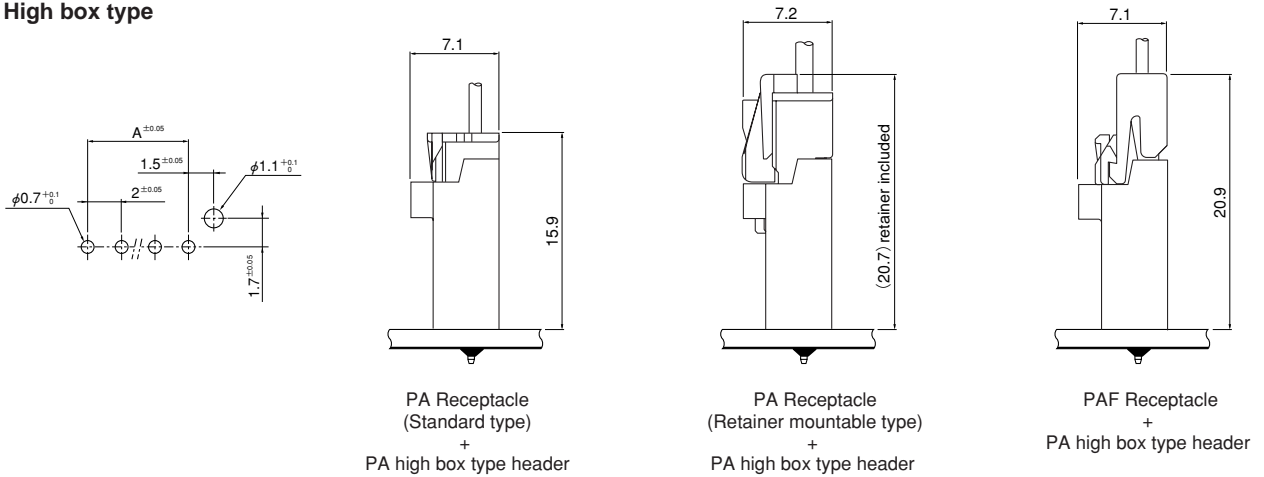

Note: 1. The above figure is the figure viewed from the connector mounting side.

2. Tolerances are non-cumulative:  $\pm 0.05$  mm for all centers.

3. Hole dimensions differ according to the type of PC board and piercing method. The dimensions above should serve as a guideline. Contact JST for details.

### <SMT type>

#### Top entry type

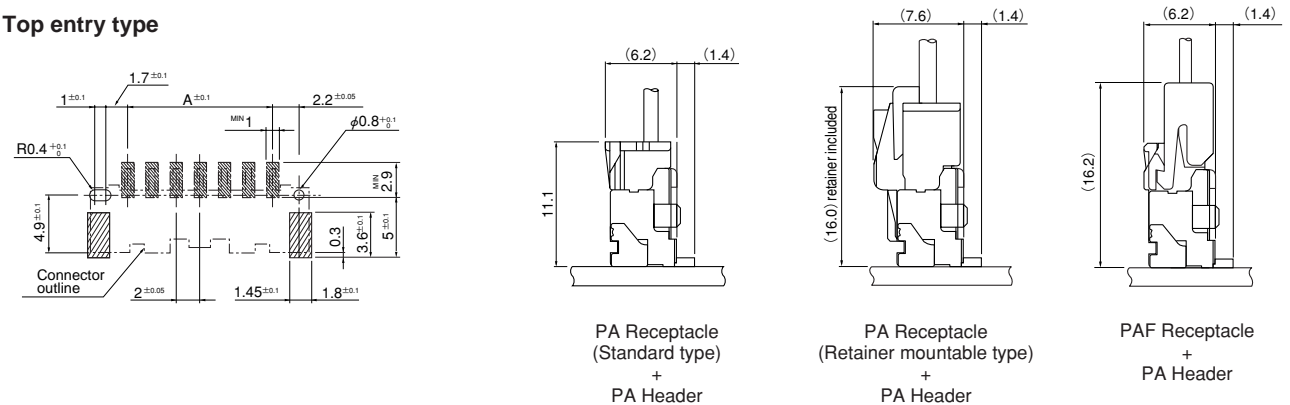

#### Side entry type

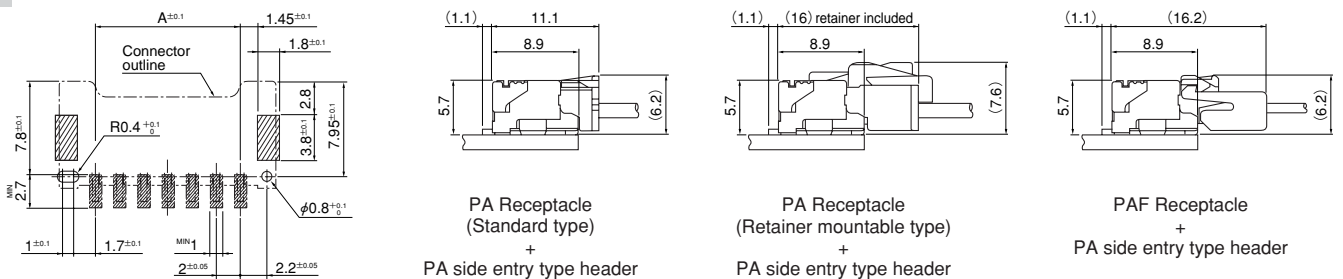

Note: 1. The above figure is the figure viewed from the connector mounting side.

2. Tolerances for the centers of pattern on PCB is  $\pm 0.05$ , and shall be not cumulative more than  $\pm 0.1$ .

3. The dimensions above should serve as a guideline. Contact JST for details.

### <Wire-to-wire>

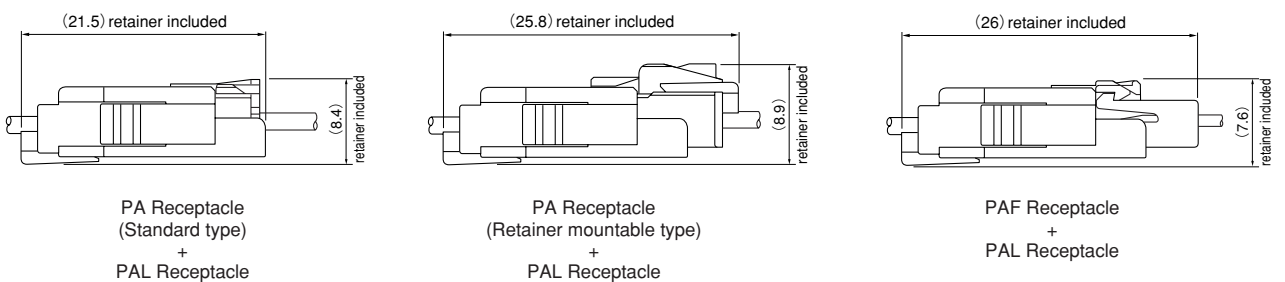

# PA FAMILY SERIES /PA CONNECTOR (Crimp style Standard type)

## Contact

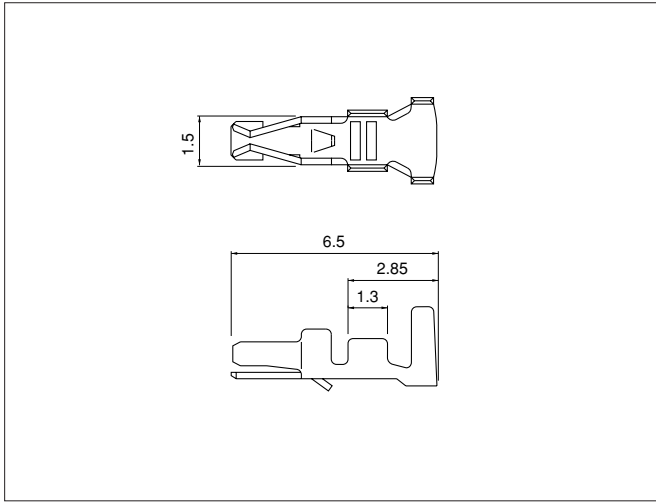

Model No.	Applicable wire		Insulation O.D. (mm)	Q'ty/reel
	mm <sup>2</sup>	AWG #		
<b>SPHD-001T-P0.5</b>	0.13~0.33	26~22	1.0~1.5	8,000
<b>SPHD-002T-P0.5</b>	0.08~0.21	28~24	0.76~1.5	8,000

### Material and Finish

Phosphor bronze, tin-plated (reflow treatment)

### RoHS compliance

Contact	Crimping machine	Applicator		
		Crimp applicator	Dies	Crimp applicator with dies
<b>SPHD-002T-P0.5</b>	AP-K2N	MKS-L-10	MK/SPHD-002-05	APLMK SPHD002-05
		*MKS-SC-10	SC/SPHD-002-05	APLSC SPHD002-05
<b>SPHD-001T-P0.5</b>		MKS-L-10	MK/SPHD-001-05	APLMK SPHD001-05
		*MKS-SC-10	SC/SPHD-001-05	APLSC SPHD001-05

Note: \*Strip-crimp applicator

## Housing

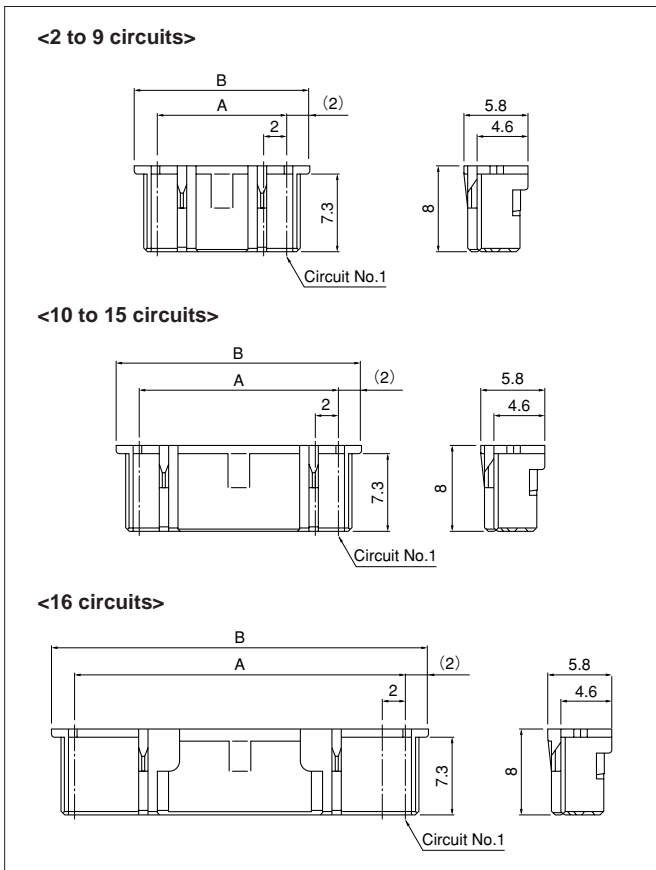

Circuits	Model No.	Dimensions (mm)		Q'ty/bag
		A	B	
2	<b>PAP-02V-S</b>	2.0	6.0	1,000
3	<b>PAP-03V-S</b>	4.0	8.0	1,000
4	<b>PAP-04V-S</b>	6.0	10.0	1,000
5	<b>PAP-05V-S</b>	8.0	12.0	1,000
6	<b>PAP-06V-S</b>	10.0	14.0	1,000
7	<b>PAP-07V-S</b>	12.0	16.0	1,000
8	<b>PAP-08V-S</b>	14.0	18.0	1,000
9	<b>PAP-09V-S</b>	16.0	20.0	1,000
10	<b>PAP-10V-S</b>	18.0	22.0	1,000
11	<b>PAP-11V-S</b>	20.0	24.0	1,000
12	<b>PAP-12V-S</b>	22.0	26.0	1,000
13	<b>PAP-13V-S</b>	24.0	28.0	1,000
14	<b>PAP-14V-S</b>	26.0	30.0	1,000
15	<b>PAP-15V-S</b>	28.0	32.0	1,000
16	<b>PAP-16V-S</b>	30.0	34.0	1,000

### Material

PA 66, UL94V-0, natural (white)

### RoHS compliance

<For reference> As the color identification, the following alphabet shall be put in the underlined part. For availability, delivery and minimum order quantity, contact JST.

ex. **PAP-02V-S**

S...natural (white)

K...black R...red E...blue M...green O...orange N...brown

P...purple PK...pink Y...yellow L...lemon yellow FY...vivid yellow

LE...light blue H...gray TR...tomato red

## Through-hole type shrouded header

### Top entry type

<2 to 9 circuits>

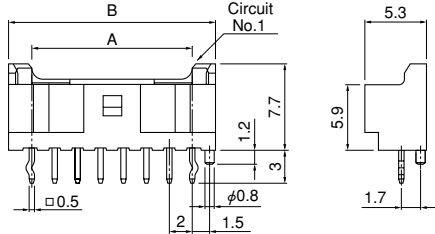

<10 to 15 circuits>

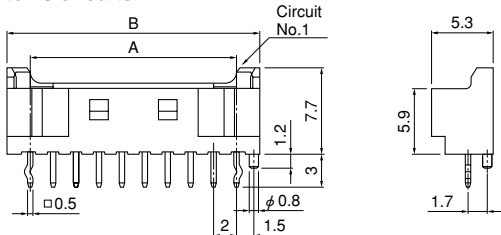

<16 circuits>

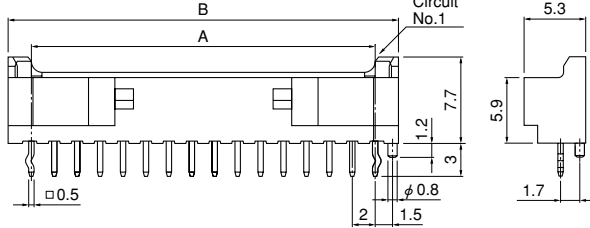

### Side entry type

<2 to 9 circuits>

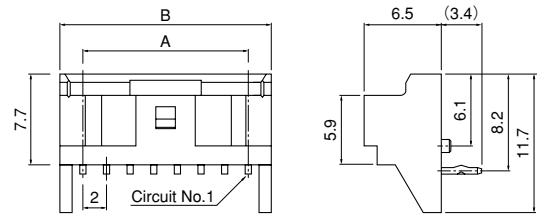

<10 to 15 circuits>

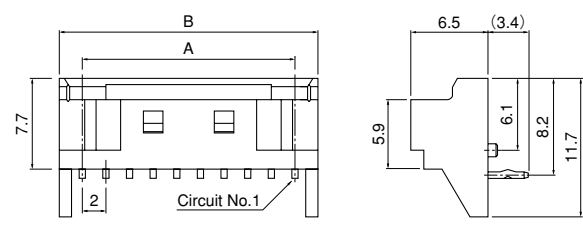

<16 circuits>

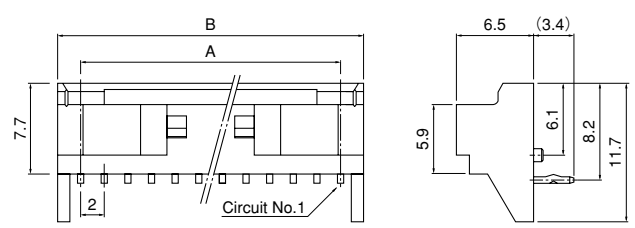

### Top entry type

Circuits	Model No.		Dimensions (mm)		Q'ty/ box
	Without boss	With a boss	A	B	
2 (Note1)	<b>B02B-PAFYK-A</b>	<b>B02B-PAFYK-1A</b>	2.0	6.0	1,000
2	<b>B02B-PASK</b>	<b>B02B-PASK-1</b>	2.0	6.0	1,000
3	<b>B03B-PASK</b>	<b>B03B-PASK-1</b>	4.0	8.0	1,000
4	<b>B04B-PASK</b>	<b>B04B-PASK-1</b>	6.0	10.0	1,000
5	<b>B05B-PASK</b>	<b>B05B-PASK-1</b>	8.0	12.0	500
6	<b>B06B-PASK</b>	<b>B06B-PASK-1</b>	10.0	14.0	500
7	<b>B07B-PASK</b>	<b>B07B-PASK-1</b>	12.0	16.0	500
8	<b>B08B-PASK</b>	<b>B08B-PASK-1</b>	14.0	18.0	500
9	<b>B09B-PASK</b>	<b>B09B-PASK-1</b>	16.0	20.0	500
10	<b>B10B-PASK</b>	<b>B10B-PASK-1</b>	18.0	22.0	500
11	<b>B11B-PASK</b>	<b>B11B-PASK-1</b>	20.0	24.0	250
12	<b>B12B-PASK</b>	<b>B12B-PASK-1</b>	22.0	26.0	250
13	<b>B13B-PASK</b>	<b>B13B-PASK-1</b>	24.0	28.0	250
14	<b>B14B-PASK</b>	<b>B14B-PASK-1</b>	26.0	30.0	250
15	<b>B15B-PASK</b>	<b>B15B-PASK-1</b>	28.0	32.0	250
16	<b>B16B-PASK</b>	<b>B16B-PASK-1</b>	30.0	34.0	250

#### Material and Finish

Post: Copper alloy, copper-undercoated, tin-plated (reflow treatment)  
Wafer: Glass-filled PBT, UL94V-0, natural (white)  
(Note1) PA 66, UL94V-0, vivid yellow

**RoHS compliance** This product displays (LF)(SN) on a label.

<For reference> As the color identification, the following alphabet shall be put in the underlined part. For availability, delivery and minimum order quantity, contact JST.

ex. **B02B-PASK**

S...natural (white)  
K...black R...red E...blue M...green O...orange N...brown  
P...purple PK...pink Y...yellow L...lemon yellow FY...vivid yellow  
LE...light blue H...gray TR...tomato red

### Side entry type

Circuits	Model No.	Dimensions (mm)		Q'ty/ box
		A	B	
2	<b>S02B-PASK-2</b>	2.0	6.0	1,000
3	<b>S03B-PASK-2</b>	4.0	8.0	1,000
4	<b>S04B-PASK-2</b>	6.0	10.0	500
5	<b>S05B-PASK-2</b>	8.0	12.0	500
6	<b>S06B-PASK-2</b>	10.0	14.0	500
7	<b>S07B-PASK-2</b>	12.0	16.0	250
8	<b>S08B-PASK-2</b>	14.0	18.0	250
9	<b>S09B-PASK-2</b>	16.0	20.0	250
10	<b>S10B-PASK-2</b>	18.0	22.0	250
11	<b>S11B-PASK-2</b>	20.0	24.0	250
12	<b>S12B-PASK-2</b>	22.0	26.0	250
13	<b>S13B-PASK-2</b>	24.0	28.0	200
14	<b>S14B-PASK-2</b>	26.0	30.0	200
15	<b>S15B-PASK-2</b>	28.0	32.0	200
16	<b>S16B-PASK-2</b>	30.0	34.0	200

#### Material and Finish

Post: Copper alloy, copper-undercoated, tin-plated (reflow treatment)  
Wafer: Glass-filled PBT, UL94V-0, natural (white)

**RoHS compliance** This product displays (LF)(SN) on a label.

<For reference> As the color identification, the following alphabet shall be put in the underlined part. For availability, delivery and minimum order quantity, contact JST.

ex. **S03B-PASK-2**

S...natural (white)  
K...black R...red E...blue M...green O...orange N...brown  
P...purple PK...pink Y...yellow L...lemon yellow LE...light blue  
H...gray TR...tomato red

# PA FAMILY SERIES

## Through-hole type shrouded header

### N type

<2 to 9 circuits>

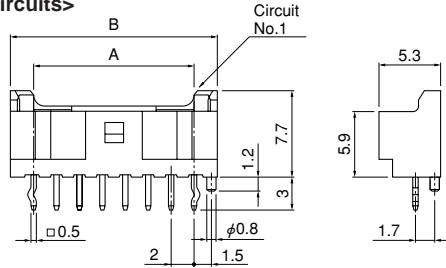

<10 to 15 circuits>

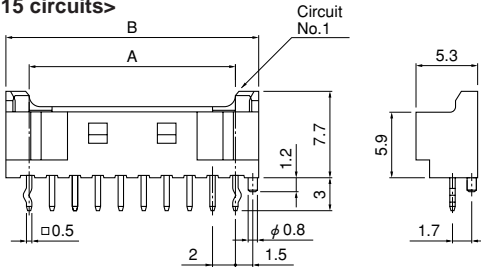

<16 circuits>

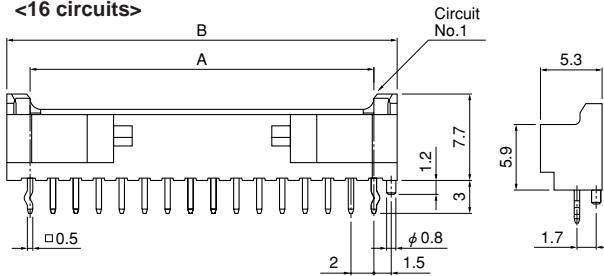

### Bottom type

<5, 8 circuits>

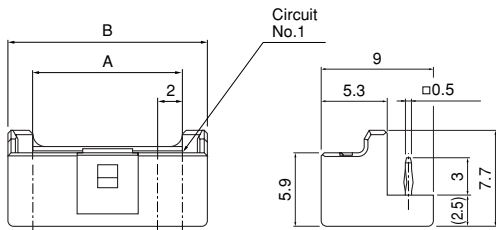

<11, 12 circuits>

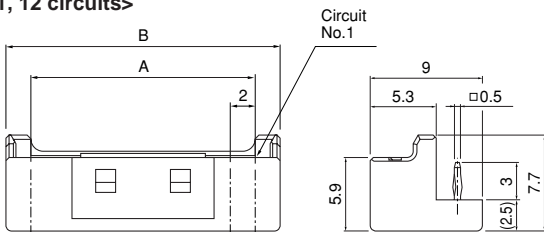

### Bottom type with extended length

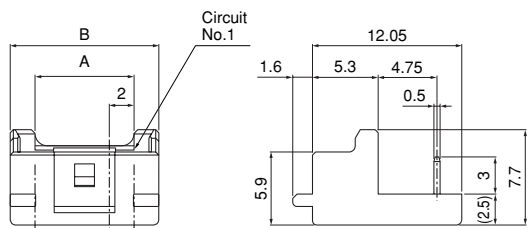

### N type

Circuits	Model No.		Dimensions (mm)		Q'ty/box
	Without boss	With a boss	A	B	
2	B02B-PASK-N	B02B-PASK-1N	2.0	6.0	1,000
3	B03B-PASK-N	B03B-PASK-1N	4.0	8.0	1,000
4	B04B-PASK-N	B04B-PASK-1N	6.0	10.0	1,000
5	B05B-PASK-N	B05B-PASK-1N	8.0	12.0	500
6	B06B-PASK-N	B06B-PASK-1N	10.0	14.0	500
7	B07B-PASK-N	B07B-PASK-1N	12.0	16.0	500
8	B08B-PASK-N	B08B-PASK-1N	14.0	18.0	500
9	B09B-PASK-N	B09B-PASK-1N	16.0	20.0	500
10	B10B-PASK-N	B10B-PASK-1N	18.0	22.0	500
11	B11B-PASK-N	B11B-PASK-1N	20.0	24.0	250
12	B12B-PASK-N	B12B-PASK-1N	22.0	26.0	250
13	B13B-PASK-N	B13B-PASK-1N	24.0	28.0	250
14	B14B-PASK-N	B14B-PASK-1N	26.0	30.0	250
15	B15B-PASK-N	B15B-PASK-1N	28.0	32.0	250
16	B16B-PASK-N	B16B-PASK-1N	30.0	34.0	250

#### Material and Finish

Post: Copper alloy, copper-undercoated, tin-plated (reflow treatment)  
Wafer: Glass-filled PA 66, UL94V-0, natural

**RoHS compliance** This product displays (LF)(SN) on a label.

### Bottom type

Circuits	Model No.	Dimensions (mm)				Q'ty/bag
		A	B	C	D	
5	BE05B-PASK	8.0	12.0	12.4	5.5	300
8	BE08B-PASK	14.0	18.0	18.4	5.5	200
11	BE11B-PASK	20.0	24.0	24.4	12.0	150
12	BE12B-PASK	22.0	26.0	26.4	12.0	150

#### Material and Finish

Post: Copper alloy, copper-undercoated, tin-plated (reflow treatment)  
Wafer: Glass-filled PBT, UL94V-0, natural

**RoHS compliance** This product displays (LF)(SN) on a label.

Note: Dimensions C and D; Refer to the PCB layout bottom type (page 3).

### Bottom type with extended length

Circuits	Model No.	Dimensions (mm)			Q'ty/box
		A	B	C	
4	BE04B-PASK-C	6.0	10.0	10.4	1,050
5	BE05B-PASK-C	8.0	12.0	12.4	875
6	BE06B-PASK-C	10.0	14.0	14.4	750

#### Material and Finish

Post: Copper alloy, copper-undercoated, tin-plated (reflow treatment)  
Wafer: Glass-filled PA 66, UL94V-0, natural

**RoHS compliance** This product displays (LF)(SN) on a label.

Note: 1. Dimensions C; Refer to the PCB layout bottom type (page 3).

2. Not UL/CSA approved.

## Shrouded header <High box type>

<2 circuits>

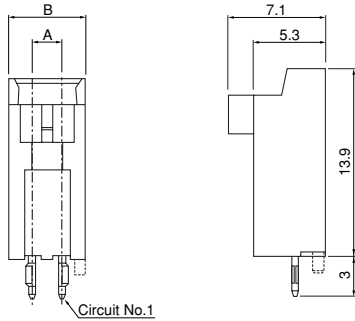

<5, 6 circuits>

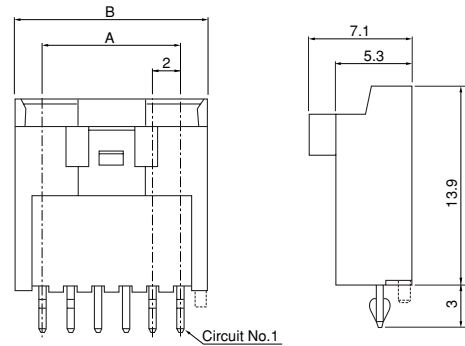

<3 circuits>

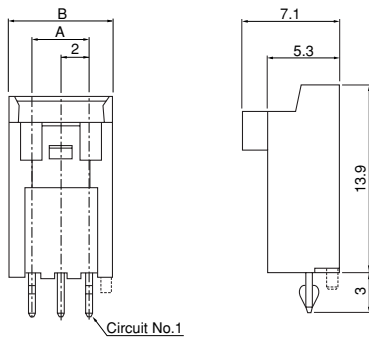

<7 to 9 circuits>

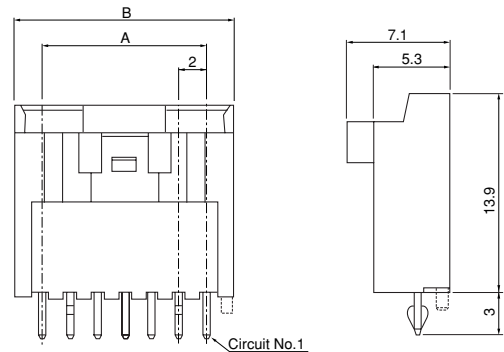

<4 circuits>

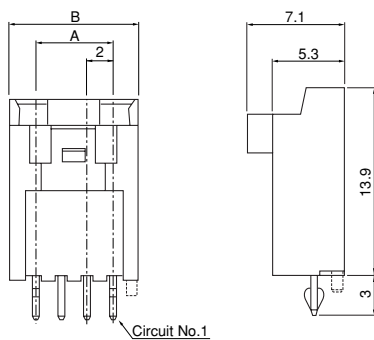

<10 to 12, 15 circuits>

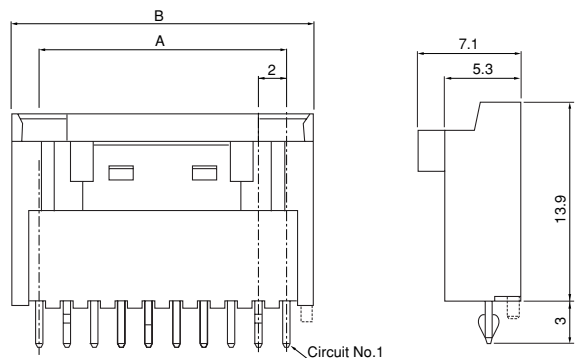

Circuits	Model No.		Dimensions(mm)		Q'ty/ box
	Without a boss	With a boss	A	B	
2	BH02B-PASK	BH02B-PASK-1	2.0	6.0	900
3	BH03B-PASK	BH03B-PASK-1	4.0	8.0	675
4	BH04B-PASK	BH04B-PASK-1	6.0	10.0	525
5	BH05B-PASK	BH05B-PASK-1	8.0	12.0	450
6	BH06B-PASK	BH06B-PASK-1	10.0	14.0	375
7	BH07B-PASK	BH07B-PASK-1	12.0	16.0	325
8	BH08B-PASK	BH08B-PASK-1	14.0	18.0	300
9	BH09B-PASK	BH09B-PASK-1	16.0	20.0	250
10	BH10B-PASK	BH10B-PASK-1	18.0	22.0	225
11	BH11B-PASK	BH11B-PASK-1	20.0	24.0	225
12	BH12B-PASK	BH12B-PASK-1	22.0	26.0	200
15	BH15B-PASK	BH15B-PASK-1	28.0	32.0	150

### Material and Finish

Post: Copper alloy, copper-undercoated, tin-plated (reflow treatment)

Wafer: Glass-filled PBT, UL94V-0, natural (white)

**RoHS compliance** This product displays (LF)(SN) on a label.



# PA FAMILY SERIES

## SMT type shrouded header

### Top entry type

<2 to 3 circuits>

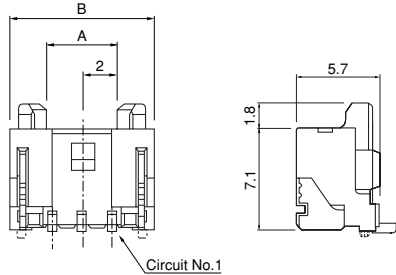

<4 to 9 circuits>

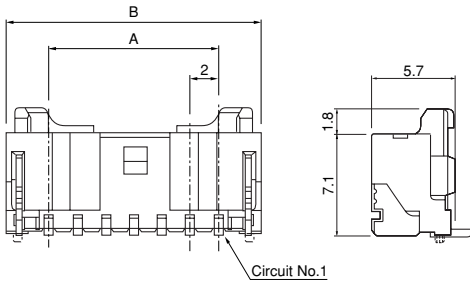

<10 to 13, 15 circuits>

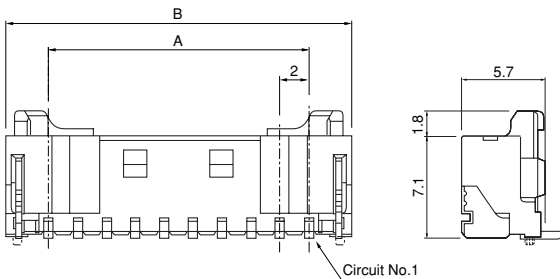

### Side entry type

<2 to 3 circuits>

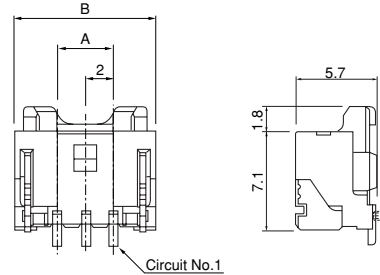

<4 to 9 circuits>

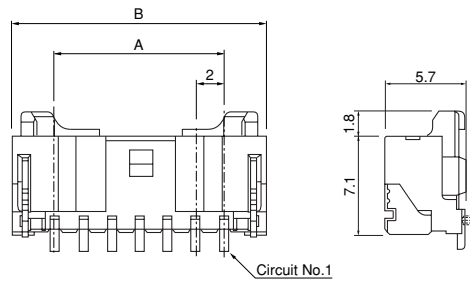

<10 to 13, 15 circuits>

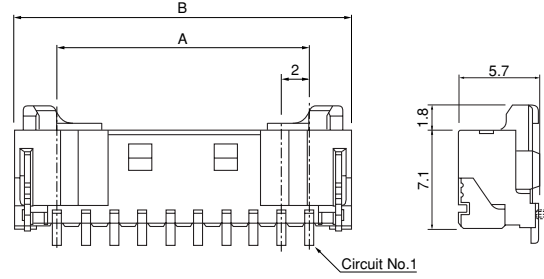

### Top entry type

Circuits	Model No.		Dimensions(mm)		Q'ty/ reel
	Without a boss	With a boss	A	B	
2	BM02B-PASS-(*)	BM02B-PASS-1-(*)	2.0	8.0	500
3	BM03B-PASS-(*)	BM03B-PASS-1-(*)	4.0	10.0	500
4	BM04B-PASS-(*)	BM04B-PASS-1-(*)	6.0	12.0	500
5	BM05B-PASS-(*)	BM05B-PASS-1-(*)	8.0	14.0	500
6	BM06B-PASS-(*)	BM06B-PASS-1-(*)	10.0	16.0	500
7	BM07B-PASS-(*)	BM07B-PASS-1-(*)	12.0	18.0	500
8	BM08B-PASS-(*)	BM08B-PASS-1-(*)	14.0	20.0	500
9	BM09B-PASS-(*)	BM09B-PASS-1-(*)	16.0	22.0	500
10	BM10B-PASS-(*)	BM10B-PASS-1-(*)	18.0	24.0	500
11	BM11B-PASS-(*)	BM11B-PASS-1-(*)	20.0	26.0	500
12	BM12B-PASS-(*)	BM12B-PASS-1-(*)	22.0	28.0	500
13	BM13B-PASS-(*)	BM13B-PASS-1-(*)	24.0	30.0	500
15	BM15B-PASS-(*)	BM15B-PASS-1-(*)	28.0	34.0	500

#### Material and Finish

Post: Copper alloy, copper-undercoated, tin-plated (reflow treatment)  
 Wafer: PA, UL94V-0, natural (ivory)  
 Solder tab: Copper alloy, copper-undercoated, tin-plated (reflow treatment)

### Side entry type

Circuits	Model No.		Dimensions(mm)		Q'ty/ reel
	Without a boss	With a boss	A	B	
2	SM02B-PASS-(*)	SM02B-PASS-1-(*)	2.0	8.0	1,000
3	SM03B-PASS-(*)	SM03B-PASS-1-(*)	4.0	10.0	1,000
4	SM04B-PASS-(*)	SM04B-PASS-1-(*)	6.0	12.0	1,000
5	SM05B-PASS-(*)	SM05B-PASS-1-(*)	8.0	14.0	1,000
6	SM06B-PASS-(*)	SM06B-PASS-1-(*)	10.0	16.0	1,000
7	SM07B-PASS-(*)	SM07B-PASS-1-(*)	12.0	18.0	1,000
8	SM08B-PASS-(*)	SM08B-PASS-1-(*)	14.0	20.0	1,000
9	SM09B-PASS-(*)	SM09B-PASS-1-(*)	16.0	22.0	1,000
10	SM10B-PASS-(*)	SM10B-PASS-1-(*)	18.0	24.0	1,000
11	SM11B-PASS-(*)	SM11B-PASS-1-(*)	20.0	26.0	1,000
12	SM12B-PASS-(*)	SM12B-PASS-1-(*)	22.0	28.0	1,000
13	SM13B-PASS-(*)	SM13B-PASS-1-(*)	24.0	30.0	1,000
15	SM15B-PASS-(*)	SM15B-PASS-1-(*)	28.0	34.0	1,000

#### Material and Finish

Post: Copper alloy, copper-undercoated, tin-plated (reflow treatment)  
 Wafer: PA, UL94V-0, natural (ivory)  
 Solder tab: Copper alloy, copper-undercoated, tin-plated (reflow treatment)

**RoHS compliance** This product displays (LF)(SN) on a label.

Note: (\*) : TF...taping product

TFT...taping product with suction tape.

**RoHS compliance** This product displays (LF)(SN) on a label.

Note: (\*) : TB...taping product

TBT...taping product with suction tape.

# PA FAMILY SERIES /PA CONNECTOR (Crimp style Retainer mountable type)

## Contact

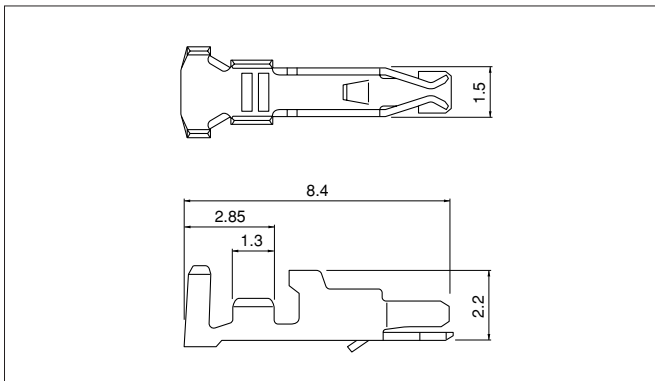

Model No.	Applicable wire		Insulation O.D. (mm)	Q'ty/ reel
	mm <sup>2</sup>	AWG #		
SPA-001T-P0.5	0.13~0.33	26~22	0.9~1.5	10,000

### Material and Finish

Phosphor bronze, tin-plated (reflow treatment)

### RoHS compliance

Contact	Crimping machine	Applicator		
		Crimp applicator	Dies	Crimp applicator with dies
SPA-001T-P0.5	AP-K2N	MKS-L	MK/SPA-001-05	APLMK SPA001-05
		—	—	—

## Housing

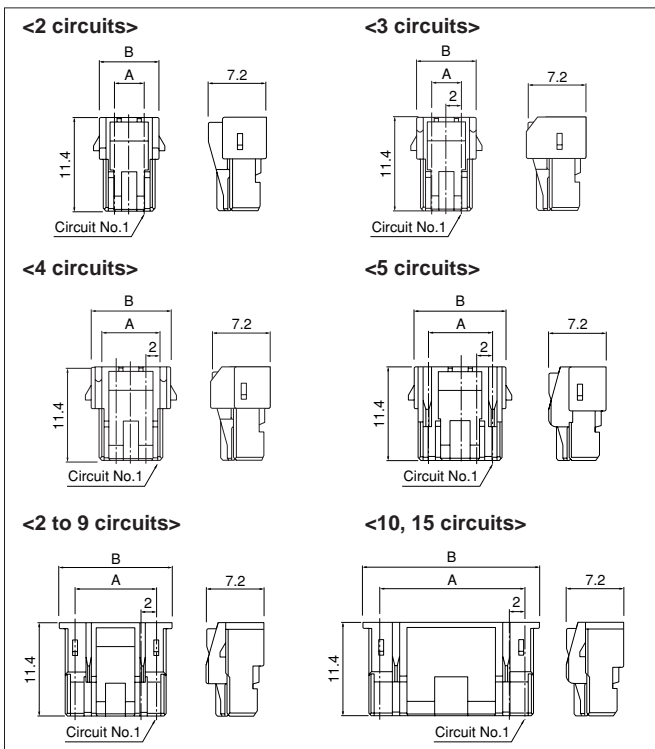

Circuits	Model No.	Dimensions (mm)		Q'ty/ bag
		A	B	
2	PARP-02V	2.0	5.4	1,000
3	PARP-03V	4.0	7.4	1,000
4	PARP-04V	6.0	9.4	1,000
5	PARP-05V	8.0	11.4	1,000
6	PARP-06V	10.0	14.0	1,000
7	PARP-07V	12.0	16.0	1,000
8	PARP-08V	14.0	18.0	1,000
9	PARP-09V	16.0	20.0	1,000
10	PARP-10V	18.0	22.0	1,000
15	PARP-15V	28.0	32.0	500

### Material

PA 66, UL94V-0, natural (white)

### RoHS compliance

Note: Contact JST for Glow Wire compliant connectors.

<For reference> As the color identification, the following alphabet shall be put in the underlined part. For availability, delivery and minimum order quantity, contact JST.

ex. **PARP-02V-oo**  
(blank)...natural (white)  
R...red E...blue Y...yellow M...green

## Retainer

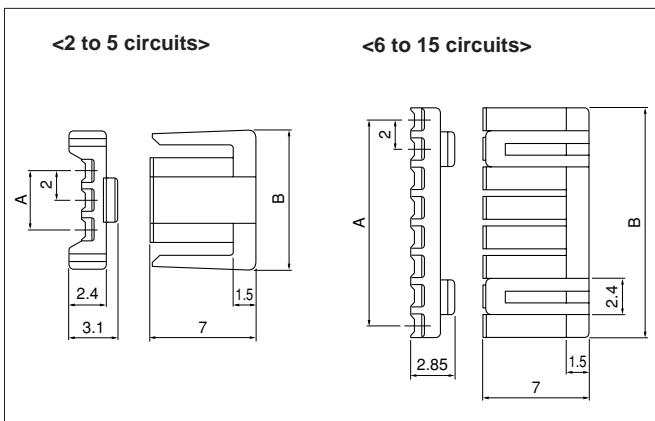

Circuits	Model No.	Dimensions (mm)		Q'ty/ bag
		A	B	
2	PMS-02V-S	2.0	7.3	1,000
3	PMS-03V-S	4.0	9.3	1,000
4	PMS-04V-S	6.0	11.3	1,000
5	PMS-05V-S	8.0	13.3	1,000
6	PMS-06V-S	10.0	11.55	1,000
7	PMS-07V-S	12.0	13.55	1,000
8	PMS-08V-S	14.0	15.55	1,000
9	PMS-09V-S	16.0	17.55	1,000
10	PMS-10V-S	18.0	19.55	1,000
15	PMS-15V-S	28.0	29.55	1,000

### Material

Glass-filled PA 66, UL94V-0, natural (ivory)

### RoHS compliance

# PA FAMILY SERIES /PAF CONNECTOR (Insulation displacement type)

## Receptacle

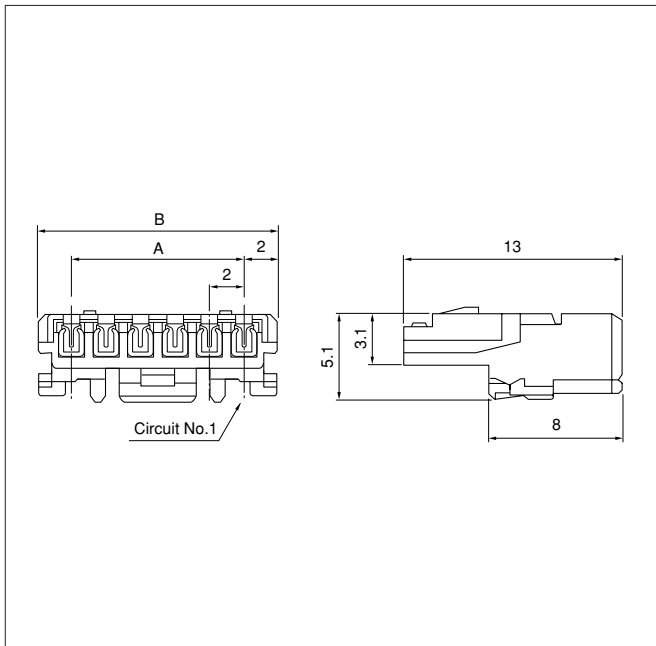

Circuits	Model No.	Dimensions (mm)		Q'ty/ box
		A	B	
2	<b>02PAF-6S</b>	2.0	6.0	1,000
3	<b>03PAF-6S</b>	4.0	8.0	1,000
4	<b>04PAF-6S</b>	6.0	10.0	500
5	<b>05PAF-6S</b>	8.0	12.0	500
6	<b>06PAF-6S</b>	10.0	14.0	500
7	<b>07PAF-6S</b>	12.0	16.0	500
8	<b>08PAF-6S</b>	14.0	18.0	250
9	<b>09PAF-6S</b>	16.0	20.0	250
10	<b>10PAF-6S</b>	18.0	22.0	250
11	<b>11PAF-6S</b>	20.0	24.0	250
12	<b>12PAF-6S</b>	22.0	26.0	250
13	<b>13PAF-6S</b>	24.0	28.0	250
14	<b>14PAF-6S</b>	26.0	30.0	250
15	<b>15PAF-6S</b>	28.0	32.0	250
*16	<b>16PAF-6S</b>	30.0	34.0	250

### Material and Finish

Contact: Phosphor bronze, tin-plated (reflow treatment)

Housing: PA 66, UL94V-0, natural (white)

### RoHS compliance

Note: \*Marked product is not UL/CSA approved.

<For reference> As the color identification, the following alphabet shall be put in the underlined part. For availability, delivery and minimum order quantity, contact JST.

ex. **02PAF-6S**

S...natural (white)

R...red E...blue M...green Y...yellow

## Retainer

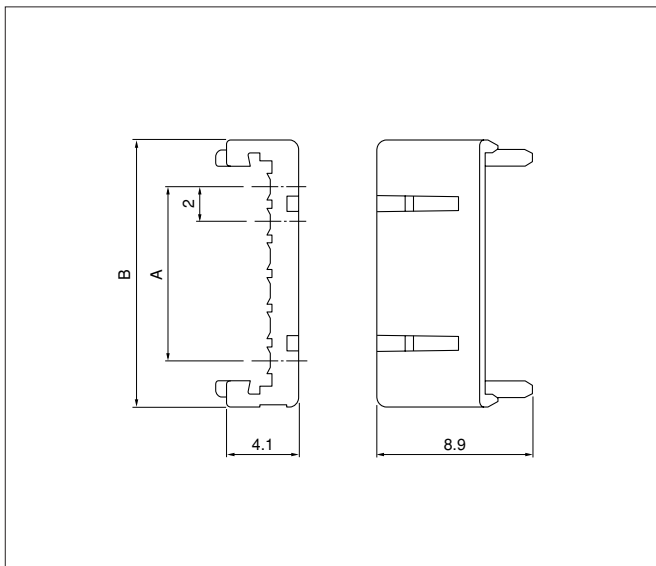

Circuits	Model No.	Dimensions (mm)		Q'ty/ bag
		A	B	
2	<b>PAFS-02V-S</b>	2.0	7.4	1,000
3	<b>PAFS-03V-S</b>	4.0	9.4	1,000
4	<b>PAFS-04V-S</b>	6.0	11.4	1,000
5	<b>PAFS-05V-S</b>	8.0	13.4	1,000
6	<b>PAFS-06V-S</b>	10.0	15.4	1,000
7	<b>PAFS-07V-S</b>	12.0	17.4	1,000
8	<b>PAFS-08V-S</b>	14.0	19.4	1,000
* 9	<b>PAFS-09V-S</b>	16.0	21.4	1,000
*10	<b>PAFS-10V-S</b>	18.0	23.4	1,000
*11	<b>PAFS-11V-S</b>	20.0	25.4	1,000
*12	<b>PAFS-12V-S</b>	22.0	27.4	1,000
*13	<b>PAFS-13V-S</b>	24.0	29.4	1,000
*14	<b>PAFS-14V-S</b>	26.0	31.4	1,000
*15	<b>PAFS-15V-S</b>	28.0	33.4	1,000

### Material

Glass-filled PA 66, UL94V-0, natural (ivory)

### RoHS compliance

Note: \*Marked products are not UL/CSA approved.

# PA FAMILY SERIES /PAL CONNECTOR (Wire-to-wire type)

## Contact

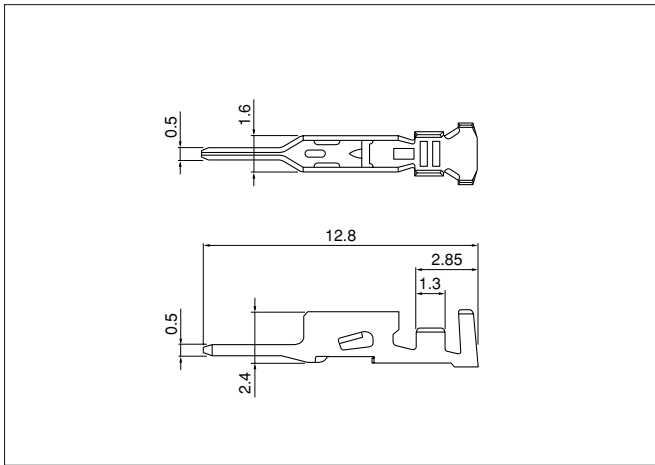

Model No.	Applicable wire		Insulation O.D. (mm)	Q'ty/ reel
	mm <sup>2</sup>	AWG #		
SPAL-001T-P0.5	0.13~0.33	26~22	1.0~1.5	10,000
SPAL-002T-P0.5	0.08~0.21	28~24	0.9~1.5	10,000

### Material and Finish

Phosphor bronze, tin-plated (reflow treatment)

### RoHS compliance

Contact	Crimping machine	Applicator		
		Crimp applicator	Dies	Crimp applicator with dies
SPAL-001T-P0.5	AP-K2N	MKS-L	MK/SPAL-001-05	APLMK SPAL001-05
		—	—	—
SPAL-002T-P0.5	AP-K2N	MKS-L	MK/SPAL-002-05	APLMK SPAL002-05
		—	—	—

## Housing

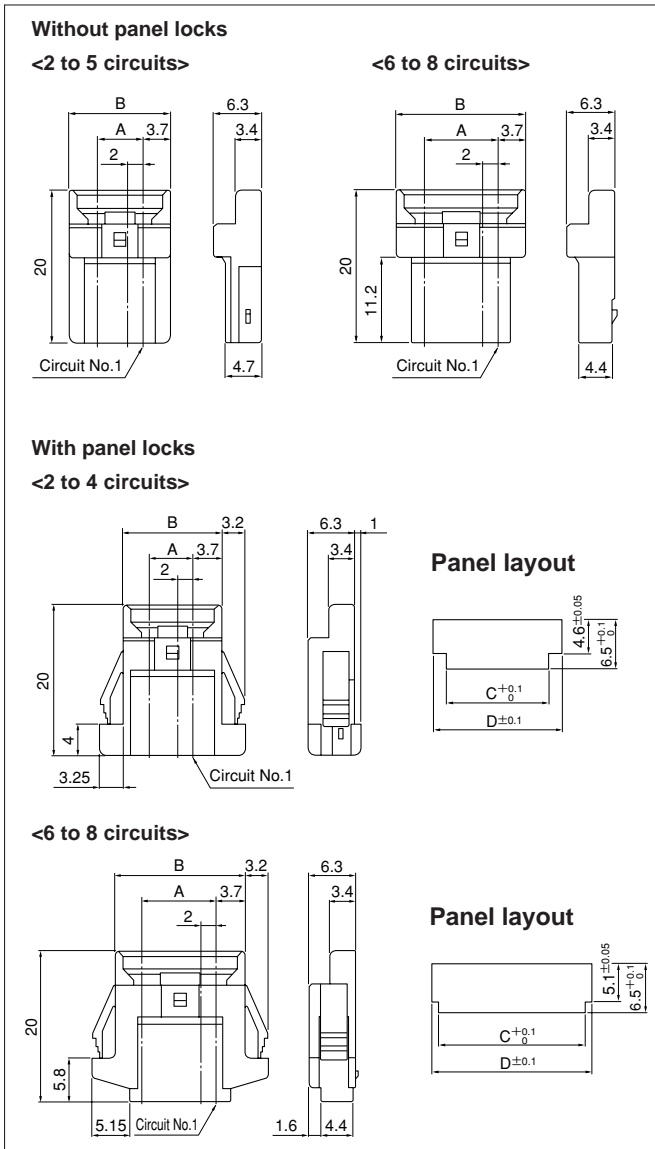

Circuits	Model No.	Dimensions (mm)		Q'ty/ bag
		A	B	
2	PALR-02VF	2.0	9.4	1,000
3	PALR-03VF	4.0	11.4	1,000
4	PALR-04VF	6.0	13.4	1,000
5	PALR-05VF	8.0	15.4	1,000
6	PALR-06VF	10.0	17.4	1,000
7	PALR-07VF	12.0	19.4	1,000
8	PALR-08VF	14.0	21.4	1,000

### Material

PA 66, UL94V-0, natural (white)

### RoHS compliance

Circuits	Model No.	Dimensions (mm)				Q'ty/ bag
		A	B	C	D	
2	PALR-02V	2.0	9.4	9.8	13.4	1,000
3	PALR-03V	4.0	11.4	11.8	15.4	1,000
4	PALR-04V	6.0	13.4	13.8	17.4	1,000
6	PALR-06V	10.0	17.4	19.8	21.4	1,000
7	PALR-07V	12.0	19.4	21.8	23.4	1,000
8	PALR-08V	14.0	21.4	23.8	25.4	1,000

### Material

PA 66, UL94V-0, natural (white)

### RoHS compliance

<For reference> As the color identification, the following alphabet shall be put in the underlined part. For availability, delivery and minimum order quantity, contact JST.

ex. **PALR-02V(F)-oo**  
(blank)...natural (white)  
R...red E...blue M...green Y...yellow

## Retainer

Retainers are interchangeable with those of the PA crimp style retainer mountable type.

## X-ON Electronics

Largest Supplier of Electrical and Electronic Components

*Click to view similar products for [Headers & Wire Housings](#) category:*

*Click to view products by [JST](#) manufacturer:*

Other Similar products are found below :

[95000-104TRLF](#) [10135584-644402LF](#) [DF62W-EP2022PCA](#) [95000-106TRLF](#) [DF62W-2022SCA](#) [DF62W-EP2022PC](#) [2203348](#) [DF62W-2022SC](#) [1084018](#) [1029039](#) [1084017](#) [802-10-012-10-002000](#) [1112640](#) [1112639](#) [891-007-9SS-BST1T](#) [000-34000](#) [0008550134](#) [0009482033](#) [0009507031](#) [57102-F02-18ULF](#) [57102-S06-03LF](#) [57202-S52-04LF](#) [PCN6-15S-2.5E](#) [0039019024](#) [58102-G61-06LF](#) [582553-1](#) [0009485154](#) [0009508121](#) [0022285053](#) [0050291907](#) [018731A](#) [LY20-4P-DT1-P1E-BR](#) [02.125.8002.8](#) [60101931](#) [60598-1 \(Cut Strip\)](#) [M1625-3R/100](#) [61062-3](#) [61082-181009](#) [CSU011177004](#) [636-1427](#) [638009-1](#) [641938-9](#) [641991-4](#) [644168-1](#) [644827-2](#) [647662-1](#) [65039-019ELF](#) [65692-001LF](#) [65781-018](#) [65781-047](#)