

By	AJO
DETAIL	USB3125
REV	E
DATE	06/06/14

Ordering Gnd
USB3125-30
 Contact Plating
 30 = 30µ" Gold
 Packing Options
 A = Tape & Reel
 Request Samples
 and Quotation
 (1000 per Reel)

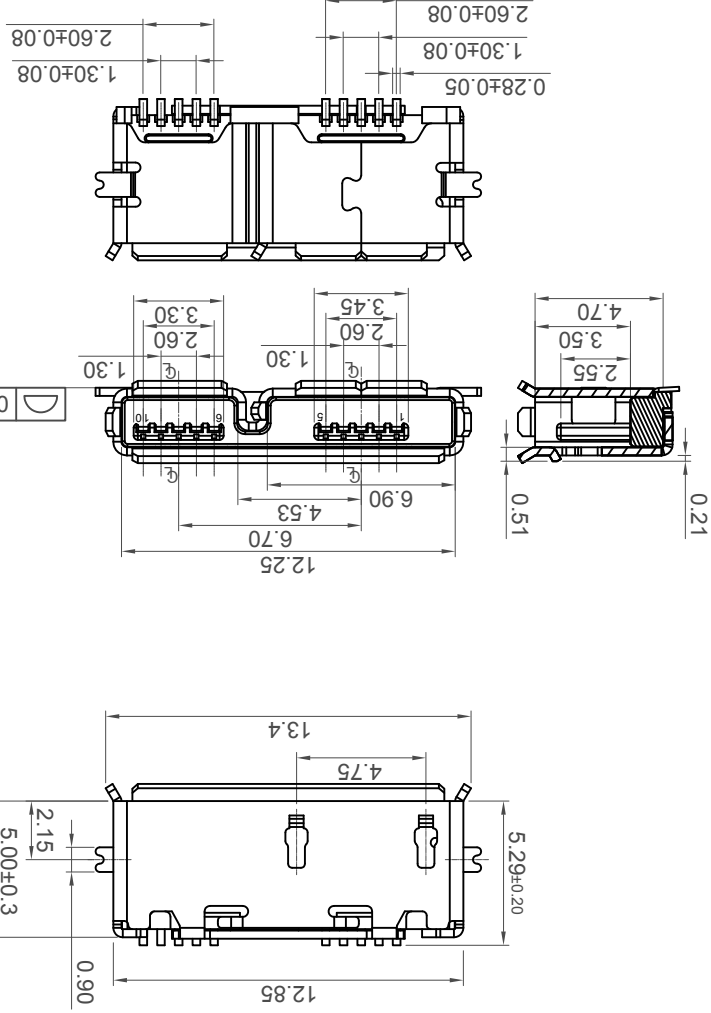

Designed to comply with physical, electrical and environmental requirements of micro USB Standard Compliance (USB3.0).

PIN NUMBER	SIGNAL NAME	DESCRIPTION	MATING SEQUENCE
1	VBUS	Power	Second
2	D-	USB 2.0 Differential pair	Last
3	D+	OTG identification	Last
4	ID	OTG identification	Last
5	GND	Ground for power return	Second
6	MicA_SSRX-	SuperSpeed receiver	Last
7	MicA_SSRX+	differential pair	Last
8	GND_DRAIN	Ground for SuperSpeed signal return	Second
9	MicA_SSTX-	SuperSpeed transmitter differential pair	Last
10	MicA_SSTX+	Connector metal shell	First

RECOMMENDED P.C.B LAYOUT
 GENERAL TOLERANCE: ±0.05

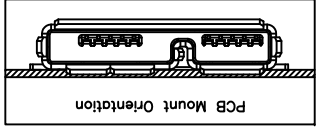
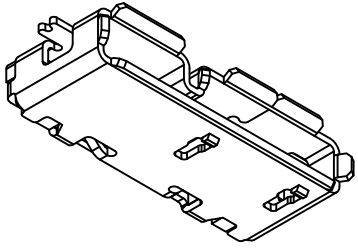
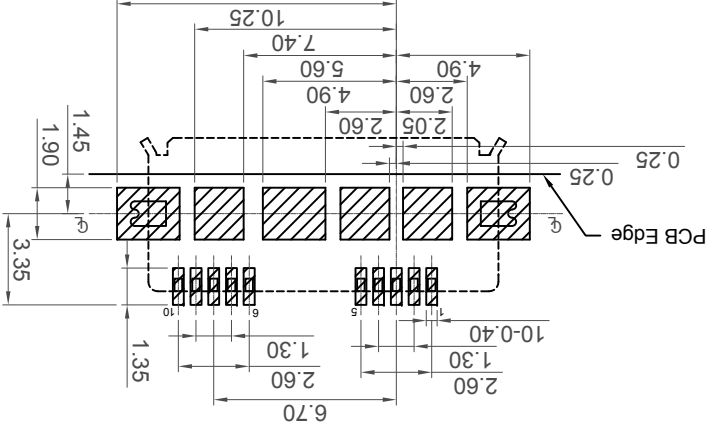

Global Connector Technology Ltd. - USB3125: USB 3.0 Micro Receptacle, Type AB, SMT, Horizontal, 10 Pin, Bottom Mount, W/SMT Holdown Pads

Part Number:-	USB3125	Date:-	16 MAY 11
Tolerances	(Excerpt as noted)		
Dimensions in mm	X.X ± 0.2 X.X ± 0.3 X.X ± 1°		
Description:-	USB 3.0 Micro Receptacle, Type AB, SMT, Horizontal, 10 Pin, Bottom Mount, with SMT Holdown Pads		
THIS DRAWING IS CONFIDENTIAL AND MUST NOT BE COPIED OR DISCLOSED WITHOUT WRITTEN CONSENT			
Scale	NTS	Revision	E
Material	See Note	Material	ASE
Drawn by	E & OE	Sheet No.	1/2



GCT
 www.gct.co

Specifications 规格:

Materials 材料:

Plastic Housing 塑胶外壳: LCP, UL94V-0,
 Black, LCP, UL94V-0 黑色
 Contact Terminal 接触端子: Copper Alloy 铜合金
 Metallic Shell 金属外壳: Stainless Steel 不锈钢
 Finish 表面处理:
 Underplating 底层电镀: Nickel
 Plating 电镀:
 Contact Area 接触面积: 30µ" Gold
 Solder Tails 焊接末端: Gold Flash
 Metallic Shell 金属外壳: Tin

Electrical 电气规格:

Voltage Rating 电压额定值: 100 V AC/DC
 Current Rating 电流额定值:
 Signal Pins 信号引脚 2,3,4,6,7,8,9,10 at 0.25A AC/DC
 & Power Pins 电源引脚 1,5 at 1.8A AC/DC

Operating Temperature 工作温度: -30°C to +85°C
 Contact Resistance 接触电阻值: 30mΩ Max.
 Insulating Resistance 绝缘电阻值: 1000MΩ Min.

Dielectric Withstand Voltage 耐电压: 100V AC/Minute
 Mechanical 机械性规格:

Mating Force 插入力: 35N Max.
 Unmating Force 拔出力: 10N Min.
 Durability 耐久性: 10000

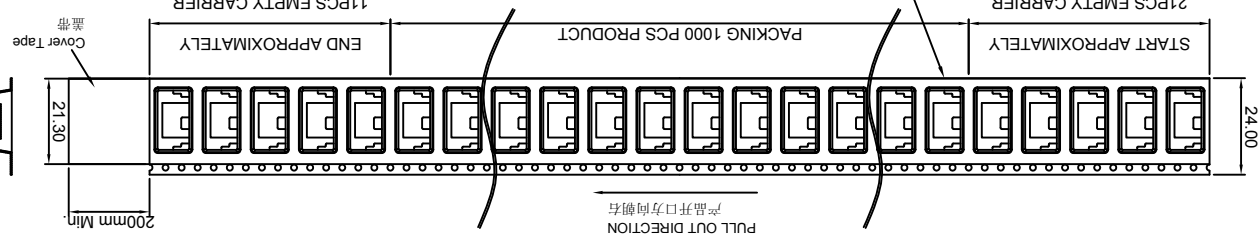
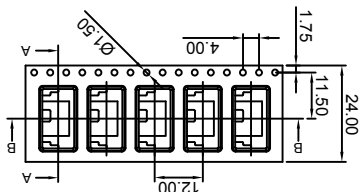

Products P/N	PCS/Reel	Reels/Carion	PCS/Carion
USB3125-30-A	1000	4	4000

Notes注意:
1. Feeling off force of top tape: 0.1-1.3N
2. All dimensions in millimeters 所有尺寸均是毫米

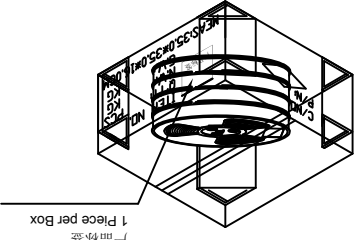
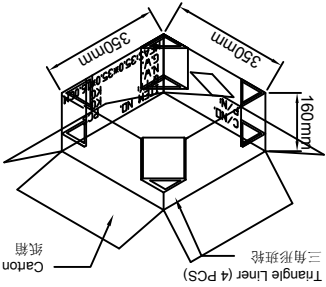
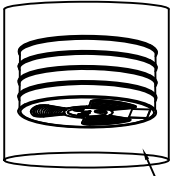
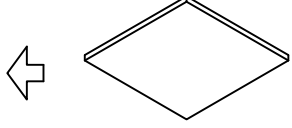
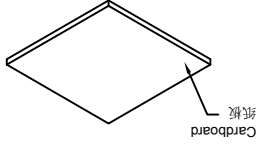
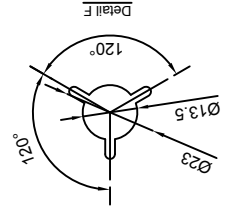
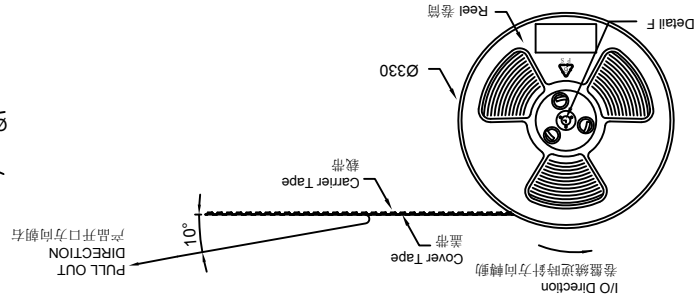

4000 Pieces per carton

By	AJO
DETAIL	USB3125
REV	E
DATE	06/06/14



Tolerances	(Except as noted)
Dimensions in mm	X.X ± 0.2 X.XX ± 0.1 X.XXX ± 0.05
Description	USB 3.0 Micro Receptacle, Type AB, SMT, Horizontal, 10 Pin, Bottom Mount, with SMT Holdown Pads
Part Number	USB3125
Date	16 MAY 11

THIS DRAWING IS CONFIDENTIAL AND MUST NOT BE COPIED OR DISCLOSED WITHOUT WRITTEN CONSENT

Scale	NTS
Revision	E
Material	See Note
Drawn by	ASE
Sheet No.	2/2
E & OE	



X-ON Electronics

Largest Supplier of Electrical and Electronic Components

Click to view similar products for [gct manufacturer](#):

Other Similar products are found below :

[BG302-03-A-L-G](#) [BD021-09A-A1-0350-0200-0550-LD](#) [BG095-10-A-N-D](#) [BG165-04-A-A-N-H](#) [BC070-06-A-1-L-D](#) [BG120-10-A-0-N-D](#)
[SIM7050-8-0-00-A](#) [BF020-03-A-B-0600-0300-N-G](#) [DCJ250-15-A-K1-C](#) [BG030-06-A-0450-0300-N-G](#) [DCJ065-05-A-K1-A](#) [USB4085-GF-A](#)
[BC085-08-A-0390-L-D](#) [BC034-10-A-V-0150-L-D](#) [BG300-06-A-L-A](#) [BG301-02-A-0540-L-B](#) [BG095-07-A-N-D](#) [BG040-06-A-0450-0300-N-G](#)
[BG030-04-A-0450-0300-N-G](#) [USB3105-30-A](#) [BD020-10-A-J-0350-0300-L-G](#) [BG303-04-A-0300-L-G](#) [DCJ235-05-A-K1-K](#) [BG301-05-A-0540-L-B](#)
[BC050-06A-K0-0200-0160-0480-LG](#) [MEM2075-00-140-01-A](#) [USB4055-30-A](#) [BG055-04A-1-0450-0530-0350-L-G](#) [BC050-10A-K0-0200-0160-0480-LD](#)
[BC070-20-A-1-L-D](#) [MEM2067-02-180-00-A](#) [BG120-04-A-0-N-D](#) [BC085-06-A-0390-L-D](#) [BC050-08A-K0-0200-0160-0480-LG](#)
[BC050-14A-K0-0200-0160-0480-LD](#) [DCJ250-10-A-K1-K](#) [BG302-05-A-L-G](#) [USB4065-30-A](#) [USB1035-GF-P-0-B-B](#) [BF085-02-A-0240-N-G](#)
[BG050-10A-0-0450-0737-0350-L-D](#) [BG302-04-A-L-G](#) [BG055-03A-1-0650-0530-0350-L-G](#) [BC075-08-A-L-D](#) [BC032-06-A-2-0200-0200-L-D](#)
[BF020-02-A-B-0400-0300-N-G](#) [BD020-03-A-J-0350-0300-L-G](#) [BC050-12A-K0-0200-0160-0480-LD](#) [USB3160-30-0170-1-C](#) [BC020-06-A-0200-0300-L-D](#)