

⚠Note • This PDF catalog is downloaded from the website of Murata Manufacturing co., Ltd. Therefore, it's specifications are subject to change or our products in it may be discontinued without advance notice. Please check with our sales representatives or product engineers before ordering.
• This PDF catalog has only typical specifications because there is no space for detailed specifications. Therefore, please approve our product specifications or transact the approval sheet for product specifications before ordering.

C49E.pdf
06.1.30

Radial Lead Type Monolithic Ceramic Capacitors

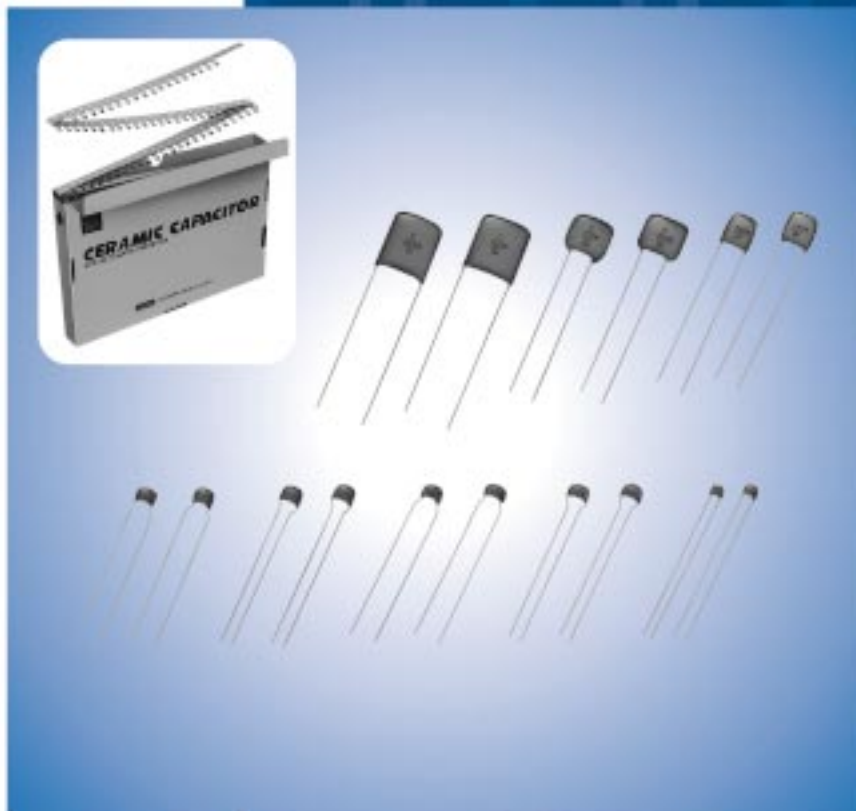

Cat.No.C49E-16

muRata *Innovator
in Electronics*
Murata
Manufacturing Co., Ltd.

CONTENTS

Part Numbering	2
Radial Lead Type Monolithic Ceramic Capacitors	3
Marking	4
Temperature Compensating Type, C0G Characteristics	5
High Dielectric Constant Type, X7R Characteristics	8
High Dielectric Constant Type, Z5U Characteristics	10
High Dielectric Constant Type, Y5V Characteristics	11
Small Size, Temperature Compensating Type, C0G Characteristics	12
Small Size, High Dielectric Constant Type, X7R Characteristics	13
Small Size, High Dielectric Constant Type, Z5U Characteristics	14
Small Size, High Dielectric Constant Type, Y5V Characteristics	14
Specifications and Test Methods	15
Characteristics Data (Typical Example)	18
Packaging	19
⚠Caution	21
Notice/QS9000 Certification	24

● Part Numbering

Radial Lead Type Monolithic Ceramic Capacitors

(Part Number)

RP	E	R7	1H	104	K	2	M1	A03	A
①	②	③	④	⑤	⑥	⑦	⑧	⑨	⑩

① Product ID

② Series/Terminal

Product ID	Series/Terminal	
RP	E	Radial Lead Type Monolithic Ceramic Capacitors

③ Temperature Characteristics

Code	Temperature Characteristics	Temperature Range	Capacitance Change or Temperature Coefficient	Operating Temperature Range
5C	C0G	25 to 125°C	0±30ppm/°C	-55 to 125°C
E4	Z5U	10 to 85°C	+22, -56%	10 to 85°C
F5	Y5V	-30 to 85°C	+22, -82%	-30 to 85°C
R7	X7R	-55 to 125°C	±15%	-55 to 125°C

④ Rated Voltage

Code	Rated Voltage
1E	DC25V
1H	DC50V
2A	DC100V

⑤ Capacitance

Expressed by three figures. The unit is pico-farad (pF). The first and second figures are significant digits, and the third figure expresses the number of zeros which follow the two numbers. If there is a decimal point, it is expressed by the capital letter "R". In this case, all figures are significant digits.

⑥ Capacitance Tolerance

Code	Capacitance Tolerance	Temperature Characteristics	Capacitance Step
C	±0.25pF	C0G	≤5pF : 1pF Step
D	±0.5pF		6 to 9pF : 1pF Step
J	±5%		≥10 : E12 Series
K	±10%	X7R	E6 Series
M	±20%	Z5U	E3 Series
Z	+80%, -20%	Y5V	E3 Series

⑦ Dimensions (LxW)

Code	Dimensions (LxW)
1	3.5×3.0mm
2	5.0×3.5mm
3	5.0×4.5mm
4	7.5×5.0mm
5	7.5×7.5mm
6	10.0×10.0mm
7	12.5×12.5mm
8	7.5×5.5mm

⑧ Lead Style

Code	Lead Style	Lead Spacing
A1	Straight Long	2.5mm
B1	Straight Long	5.0mm
C1	Straight Long	10.0mm
E1/E2	Straight Taping	5.0mm
K1	Inside Crimp	5.0mm
M1/M2	Inside Crimp Taping	5.0mm
P1	Outside Crimp	2.5mm
S1/S2	Outside Crimp Taping	2.5mm

Lead distance between reference and bottom planes.

M1, S1 : H₀ = 16.0±0.5mm

M2, S2 : H₀ = 20.0±0.5mm

E1 : H = 17.5±0.5mm

E2 : H = 20.0±0.5mm

⑨ Individual Specification Code

Expressed by three figures

⑩ Packaging

Code	Packaging
A	Ammo Pack
B	Bulk

Radial Lead Type Monolithic Ceramic Capacitors



Radial Lead Type Monolithic Ceramic Capacitors

■ Features

1. The RPE series capacitors have small dimensions, large capacitance, and a capacity volume ratio of 10 micro F/cm cube, close to that of electrolytic capacitors. These do not have polarity.
2. These have excellent frequency characteristics and due to these small internal inductance are suitable for high frequencies.
3. These are not coated with wax so there is no change in their exterior appearance due to the outflow of wax during soldering or solvent during cleansing.
4. These are highly inflammable, having characteristics equivalent to the UL94V-0 standard.

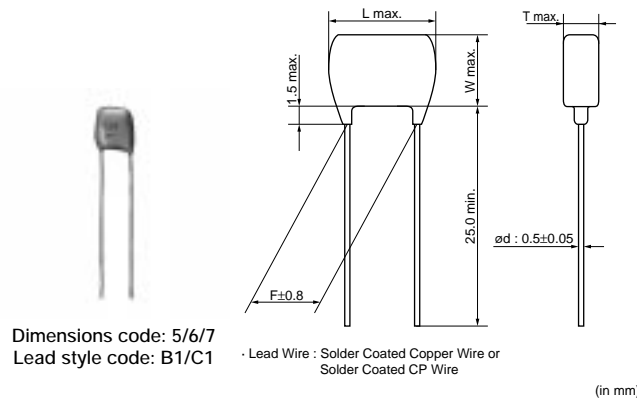
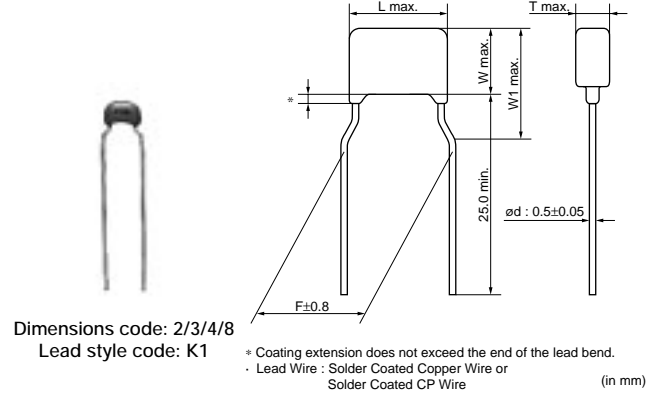
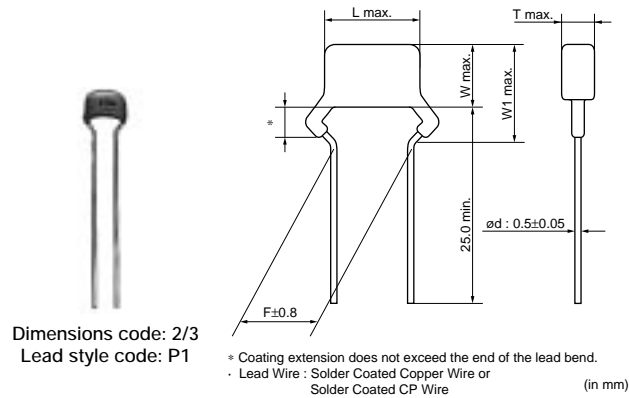
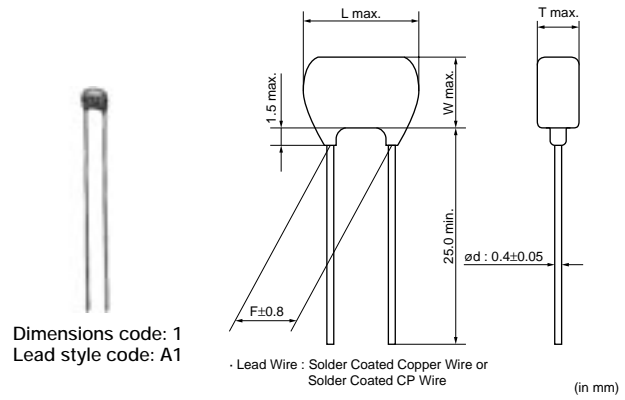

■ Dimensions

Dimensions and Lead style code	Dimensions (mm)					
	L	W	W1	T	F	d
1A1	3.5	3.0	-	See the individual product specification	2.5	0.4
2P1/2S1/2S2	5.0	3.5	5.0		2.5	0.5
2K1/2M1/2M2	5.0	3.5	5.0		5.0	0.5
3P1/3S1/3S2	5.0	4.5	6.3		2.5	0.5
3K1/3M1/3M2	5.0	4.5	6.3		5.0	0.5
4K1/4M1/4M2	7.5	5.0	7.0		5.0	0.5
5B1/5E1/5E2	7.5	7.5	-		5.0	0.5
6B1/6E1/6E2	10.0	10.0	-		5.0	0.5
7C1	12.5	12.5	-		10.0	0.5
8K1/8M1/8M2	7.5	5.5	8.0		5.0	0.5
TB1/TE1/TE2	10.0	8.5	-		5.0	0.5

Continued on the following page. ↗

△Note • This PDF catalog is downloaded from the website of Murata Manufacturing co., Ltd. Therefore, it's specifications are subject to change or our products in it may be discontinued without advance notice. Please check with our sales representatives or product engineers before ordering.
 • This PDF catalog has only typical specifications because there is no space for detailed specifications. Therefore, please approve our product specifications or transact the approval sheet for product specifications before ordering.

Continued from the preceding page.

■ Marking

Dimensions Code	Type	Temperature Compensating Type	High Dielectric Constant Type		
	Temp. Char.	C0G	X7R	Z5U	Y5V
1	Individual Specification Code A□□ B□□ Z□□	 Marked on both sides			
3, 4, 8					
5, 6, 7					
Temperature Characteristics	Marked with code (C0G char.: A, X7R char.: C, Z5U char.: E, Y5V char.: F) A part is omitted (Please refer marking example)				
Nominal Capacitance	Under 100pF: Actual value 100pF and over: marked with 3 figures				
Capacitance Tolerance	Marked with code				
Rated Voltage	Marked with code (DC25V: 2, DC50V: 5, DC100V: 1) A part is omitted (Please refer marking example)				
Manufacturer's Identification	Marked with A part is omitted (Please refer marking example)				

Temperature Compensating Type, C0G Characteristics

Part Number	Temp. Char.	Rated Voltage (Vdc)	Capacitance (pF)	Dimensions LxW (mm)	Dimension T (mm)	Lead Space F (mm)	Lead Style Code Bulk	Lead Style Code Taping (1)	Lead Style Code Taping (2)
RPE5C1H1R0C2□□B03□	C0G	50	1.0 ±0.25pF	5.0 x 3.5	2.5	2.5	P1	S1	S2
RPE5C1H1R0C2□□B03□	C0G	50	1.0 ±0.25pF	5.0 x 3.5	2.5	5.0	K1	M1	M2
RPE5C1H2R0C2□□B03□	C0G	50	2.0 ±0.25pF	5.0 x 3.5	2.5	2.5	P1	S1	S2
RPE5C1H2R0C2□□B03□	C0G	50	2.0 ±0.25pF	5.0 x 3.5	2.5	5.0	K1	M1	M2
RPE5C1H3R0C2□□B03□	C0G	50	3.0 ±0.25pF	5.0 x 3.5	2.5	2.5	P1	S1	S2
RPE5C1H3R0C2□□B03□	C0G	50	3.0 ±0.25pF	5.0 x 3.5	2.5	5.0	K1	M1	M2
RPE5C1H4R0C2□□B03□	C0G	50	4.0 ±0.25pF	5.0 x 3.5	2.5	2.5	P1	S1	S2
RPE5C1H4R0C2□□B03□	C0G	50	4.0 ±0.25pF	5.0 x 3.5	2.5	5.0	K1	M1	M2
RPE5C1H5R0C2□□B03□	C0G	50	5.0 ±0.25pF	5.0 x 3.5	2.5	2.5	P1	S1	S2
RPE5C1H5R0C2□□B03□	C0G	50	5.0 ±0.25pF	5.0 x 3.5	2.5	5.0	K1	M1	M2
RPE5C1H6R0D2□□B03□	C0G	50	6.0 ±0.5pF	5.0 x 3.5	2.5	2.5	P1	S1	S2
RPE5C1H6R0D2□□B03□	C0G	50	6.0 ±0.5pF	5.0 x 3.5	2.5	5.0	K1	M1	M2
RPE5C1H7R0D2□□Z03□	C0G	50	7.0 ±0.5pF	5.0 x 3.5	2.5	2.5	P1	S1	S2
RPE5C1H7R0D2□□Z03□	C0G	50	7.0 ±0.5pF	5.0 x 3.5	2.5	5.0	K1	M1	M2
RPE5C1H8R0D2□□Z03□	C0G	50	8.0 ±0.5pF	5.0 x 3.5	2.5	2.5	P1	S1	S2
RPE5C1H8R0D2□□Z03□	C0G	50	8.0 ±0.5pF	5.0 x 3.5	2.5	5.0	K1	M1	M2
RPE5C1H9R0D2□□Z03□	C0G	50	9.0 ±0.5pF	5.0 x 3.5	2.5	2.5	P1	S1	S2
RPE5C1H9R0D2□□Z03□	C0G	50	9.0 ±0.5pF	5.0 x 3.5	2.5	5.0	K1	M1	M2
RPE5C1H100J2□□Z03□	C0G	50	10 ±5%	5.0 x 3.5	2.5	2.5	P1	S1	S2
RPE5C1H100J2□□Z03□	C0G	50	10 ±5%	5.0 x 3.5	2.5	5.0	K1	M1	M2
RPE5C1H120J2□□Z03□	C0G	50	12 ±5%	5.0 x 3.5	2.5	2.5	P1	S1	S2
RPE5C1H120J2□□Z03□	C0G	50	12 ±5%	5.0 x 3.5	2.5	5.0	K1	M1	M2
RPE5C1H150J2□□Z03□	C0G	50	15 ±5%	5.0 x 3.5	2.5	2.5	P1	S1	S2
RPE5C1H150J2□□Z03□	C0G	50	15 ±5%	5.0 x 3.5	2.5	5.0	K1	M1	M2
RPE5C1H180J2□□Z03□	C0G	50	18 ±5%	5.0 x 3.5	2.5	2.5	P1	S1	S2
RPE5C1H180J2□□Z03□	C0G	50	18 ±5%	5.0 x 3.5	2.5	5.0	K1	M1	M2
RPE5C1H220J2□□Z03□	C0G	50	22 ±5%	5.0 x 3.5	2.5	2.5	P1	S1	S2
RPE5C1H220J2□□Z03□	C0G	50	22 ±5%	5.0 x 3.5	2.5	5.0	K1	M1	M2
RPE5C1H270J2□□Z03□	C0G	50	27 ±5%	5.0 x 3.5	2.5	2.5	P1	S1	S2
RPE5C1H270J2□□Z03□	C0G	50	27 ±5%	5.0 x 3.5	2.5	5.0	K1	M1	M2
RPE5C1H330J2□□Z03□	C0G	50	33 ±5%	5.0 x 3.5	2.5	2.5	P1	S1	S2
RPE5C1H330J2□□Z03□	C0G	50	33 ±5%	5.0 x 3.5	2.5	5.0	K1	M1	M2
RPE5C1H390J2□□Z03□	C0G	50	39 ±5%	5.0 x 3.5	2.5	2.5	P1	S1	S2
RPE5C1H390J2□□Z03□	C0G	50	39 ±5%	5.0 x 3.5	2.5	5.0	K1	M1	M2
RPE5C1H470J2□□Z03□	C0G	50	47 ±5%	5.0 x 3.5	2.5	2.5	P1	S1	S2
RPE5C1H470J2□□Z03□	C0G	50	47 ±5%	5.0 x 3.5	2.5	5.0	K1	M1	M2
RPE5C1H560J2□□Z03□	C0G	50	56 ±5%	5.0 x 3.5	2.5	2.5	P1	S1	S2
RPE5C1H560J2□□Z03□	C0G	50	56 ±5%	5.0 x 3.5	2.5	5.0	K1	M1	M2
RPE5C1H680J2□□Z03□	C0G	50	68 ±5%	5.0 x 3.5	2.5	2.5	P1	S1	S2
RPE5C1H680J2□□Z03□	C0G	50	68 ±5%	5.0 x 3.5	2.5	5.0	K1	M1	M2
RPE5C1H820J2□□Z03□	C0G	50	82 ±5%	5.0 x 3.5	2.5	2.5	P1	S1	S2
RPE5C1H820J2□□Z03□	C0G	50	82 ±5%	5.0 x 3.5	2.5	5.0	K1	M1	M2
RPE5C1H101J2□□A03□	C0G	50	100 ±5%	5.0 x 3.5	2.5	2.5	P1	S1	S2
RPE5C1H101J2□□A03□	C0G	50	100 ±5%	5.0 x 3.5	2.5	5.0	K1	M1	M2
RPE5C1H121J2□□A03□	C0G	50	120 ±5%	5.0 x 3.5	2.5	2.5	P1	S1	S2
RPE5C1H121J2□□A03□	C0G	50	120 ±5%	5.0 x 3.5	2.5	5.0	K1	M1	M2
RPE5C1H151J2□□A03□	C0G	50	150 ±5%	5.0 x 3.5	2.5	2.5	P1	S1	S2
RPE5C1H151J2□□A03□	C0G	50	150 ±5%	5.0 x 3.5	2.5	5.0	K1	M1	M2
RPE5C1H181J2□□A03□	C0G	50	180 ±5%	5.0 x 3.5	2.5	2.5	P1	S1	S2
RPE5C1H181J2□□A03□	C0G	50	180 ±5%	5.0 x 3.5	2.5	5.0	K1	M1	M2
RPE5C1H221J2□□A03□	C0G	50	220 ±5%	5.0 x 3.5	2.5	2.5	P1	S1	S2
RPE5C1H221J2□□A03□	C0G	50	220 ±5%	5.0 x 3.5	2.5	5.0	K1	M1	M2
RPE5C1H271J2□□A03□	C0G	50	270 ±5%	5.0 x 3.5	2.5	2.5	P1	S1	S2
RPE5C1H271J2□□A03□	C0G	50	270 ±5%	5.0 x 3.5	2.5	5.0	K1	M1	M2

Continued on the following page. 

△Note • This PDF catalog is downloaded from the website of Murata Manufacturing co., Ltd. Therefore, it's specifications are subject to change or our products in it may be discontinued without advance notice. Please check with our sales representatives or product engineers before ordering.
 • This PDF catalog has only typical specifications because there is no space for detailed specifications. Therefore, please approve our product specifications or transact the approval sheet for product specifications before ordering.

Continued from the preceding page.

Part Number	Temp. Char.	Rated Voltage (Vdc)	Capacitance (pF)	Dimensions LxW (mm)	Dimension T (mm)	Lead Space F (mm)	Lead Style Code Bulk	Lead Style Code Taping (1)	Lead Style Code Taping (2)
RPE5C1H331J2□□A03□	C0G	50	330 ±5%	5.0 x 3.5	2.5	2.5	P1	S1	S2
RPE5C1H331J2□□A03□	C0G	50	330 ±5%	5.0 x 3.5	2.5	5.0	K1	M1	M2
RPE5C1H391J2□□A03□	C0G	50	390 ±5%	5.0 x 3.5	2.5	2.5	P1	S1	S2
RPE5C1H391J2□□A03□	C0G	50	390 ±5%	5.0 x 3.5	2.5	5.0	K1	M1	M2
RPE5C1H471J2□□A03□	C0G	50	470 ±5%	5.0 x 3.5	2.5	2.5	P1	S1	S2
RPE5C1H471J2□□A03□	C0G	50	470 ±5%	5.0 x 3.5	2.5	5.0	K1	M1	M2
RPE5C1H561J2□□A03□	C0G	50	560 ±5%	5.0 x 3.5	2.5	2.5	P1	S1	S2
RPE5C1H561J2□□A03□	C0G	50	560 ±5%	5.0 x 3.5	2.5	5.0	K1	M1	M2
RPE5C1H681J2□□A03□	C0G	50	680 ±5%	5.0 x 3.5	2.5	2.5	P1	S1	S2
RPE5C1H681J2□□A03□	C0G	50	680 ±5%	5.0 x 3.5	2.5	5.0	K1	M1	M2
RPE5C1H821J2□□A03□	C0G	50	820 ±5%	5.0 x 3.5	2.5	2.5	P1	S1	S2
RPE5C1H821J2□□A03□	C0G	50	820 ±5%	5.0 x 3.5	2.5	5.0	K1	M1	M2
RPE5C1H102J2□□A03□	C0G	50	1000 ±5%	5.0 x 3.5	2.5	2.5	P1	S1	S2
RPE5C1H102J2□□A03□	C0G	50	1000 ±5%	5.0 x 3.5	2.5	5.0	K1	M1	M2
RPE5C1H122J2□□A03□	C0G	50	1200 ±5%	5.0 x 3.5	3.15	2.5	P1	S1	S2
RPE5C1H122J2□□A03□	C0G	50	1200 ±5%	5.0 x 3.5	3.15	5.0	K1	M1	M2
RPE5C1H152J2□□A03□	C0G	50	1500 ±5%	5.0 x 3.5	3.15	2.5	P1	S1	S2
RPE5C1H152J2□□A03□	C0G	50	1500 ±5%	5.0 x 3.5	3.15	5.0	K1	M1	M2
RPE5C1H182J2□□C03□	C0G	50	1800 ±5%	5.0 x 3.5	3.15	2.5	P1	S1	S2
RPE5C1H182J2□□A03□	C0G	50	1800 ±5%	5.0 x 3.5	3.15	5.0	K1	M1	M2
RPE5C1H222J2□□C03□	C0G	50	2200 ±5%	5.0 x 3.5	3.15	2.5	P1	S1	S2
RPE5C1H222J2□□A03□	C0G	50	2200 ±5%	5.0 x 3.5	3.15	5.0	K1	M1	M2
RPE5C1H272J2□□C03□	C0G	50	2700 ±5%	5.0 x 3.5	3.15	2.5	P1	S1	S2
RPE5C1H272J2□□A03□	C0G	50	2700 ±5%	5.0 x 3.5	3.15	5.0	K1	M1	M2
RPE5C1H332J2□□C03□	C0G	50	3300 ±5%	5.0 x 3.5	3.15	2.5	P1	S1	S2
RPE5C1H332J2□□A03□	C0G	50	3300 ±5%	5.0 x 3.5	3.15	5.0	K1	M1	M2
RPE5C1H392J2□□C03□	C0G	50	3900 ±5%	5.0 x 3.5	3.15	2.5	P1	S1	S2
RPE5C1H392J2□□A03□	C0G	50	3900 ±5%	5.0 x 3.5	3.15	5.0	K1	M1	M2
RPE5C1H472J2□□C03□	C0G	50	4700 ±5%	5.0 x 3.5	3.15	2.5	P1	S1	S2
RPE5C1H472J2□□A03□	C0G	50	4700 ±5%	5.0 x 3.5	3.15	5.0	K1	M1	M2
RPE5C1H562J2□□C03□	C0G	50	5600 ±5%	5.0 x 3.5	3.15	2.5	P1	S1	S2
RPE5C1H562J2□□A03□	C0G	50	5600 ±5%	5.0 x 3.5	3.15	5.0	K1	M1	M2
RPE5C1H682J2□□C03□	C0G	50	6800 ±5%	5.0 x 3.5	3.15	5.0	K1	M1	M2
RPE5C1H822J2□□C03□	C0G	50	8200 ±5%	5.0 x 3.5	3.15	5.0	K1	M1	M2
RPE5C1H103J2□□C03□	C0G	50	10000 ±5%	5.0 x 3.5	3.15	5.0	K1	M1	M2
RPE5C1H123J4□□F03□	C0G	50	12000 ±5%	7.5 x 5.0	3.15	5.0	K1	M1	M2
RPE5C1H153J4□□F03□	C0G	50	15000 ±5%	7.5 x 5.0	3.15	5.0	K1	M1	M2
RPE5C1H183J5□□X03□	C0G	50	18000 ±5%	7.5 x 7.5	4.0	5.0	B1	E1	E2
RPE5C1H223J6□□F12□	C0G	50	22000 ±5%	10.0 x 10.0	4.0	5.0	B1	E1	E2
RPE5C1H273J6□□F12□	C0G	50	27000 ±5%	10.0 x 10.0	4.0	5.0	B1	E1	E2
RPE5C1H333J6□□F03□	C0G	50	33000 ±5%	10.0 x 10.0	4.0	5.0	B1	E1	E2
RPE5C1H393J6□□F03□	C0G	50	39000 ±5%	10.0 x 10.0	4.0	5.0	B1	E1	E2
RPE5C1H473J7□□F03□	C0G	50	47000 ±5%	12.5 x 12.5	5.0	10.0	C1	-	-
RPE5C1H563J7□□F03□	C0G	50	56000 ±5%	12.5 x 12.5	5.0	10.0	C1	-	-
RPE5C1H683J7□□F03□	C0G	50	68000 ±5%	12.5 x 12.5	5.0	10.0	C1	-	-
RPE5C2A1R0C2□□B03□	C0G	100	1.0 ±0.25pF	5.0 x 3.5	2.5	2.5	P1	S1	S2
RPE5C2A1R0C2□□B03□	C0G	100	1.0 ±0.25pF	5.0 x 3.5	2.5	5.0	K1	M1	M2
RPE5C2A2R0C2□□B03□	C0G	100	2.0 ±0.25pF	5.0 x 3.5	2.5	2.5	P1	S1	S2
RPE5C2A2R0C2□□B03□	C0G	100	2.0 ±0.25pF	5.0 x 3.5	2.5	5.0	K1	M1	M2
RPE5C2A3R0C2□□B03□	C0G	100	3.0 ±0.25pF	5.0 x 3.5	2.5	2.5	P1	S1	S2
RPE5C2A3R0C2□□B03□	C0G	100	3.0 ±0.25pF	5.0 x 3.5	2.5	5.0	K1	M1	M2
RPE5C2A4R0C2□□B03□	C0G	100	4.0 ±0.25pF	5.0 x 3.5	2.5	2.5	P1	S1	S2
RPE5C2A4R0C2□□B03□	C0G	100	4.0 ±0.25pF	5.0 x 3.5	2.5	5.0	K1	M1	M2
RPE5C2A5R0C2□□B03□	C0G	100	5.0 ±0.25pF	5.0 x 3.5	2.5	2.5	P1	S1	S2
RPE5C2A5R0C2□□B03□	C0G	100	5.0 ±0.25pF	5.0 x 3.5	2.5	5.0	K1	M1	M2
RPE5C2A6R0D2□□B03□	C0G	100	6.0 ±0.5pF	5.0 x 3.5	2.5	2.5	P1	S1	S2
RPE5C2A6R0D2□□B03□	C0G	100	6.0 ±0.5pF	5.0 x 3.5	2.5	5.0	K1	M1	M2

Continued on the following page. ↗

△Note • This PDF catalog is downloaded from the website of Murata Manufacturing co., Ltd. Therefore, it's specifications are subject to change or our products in it may be discontinued without advance notice. Please check with our sales representatives or product engineers before ordering.
 • This PDF catalog has only typical specifications because there is no space for detailed specifications. Therefore, please approve our product specifications or transact the approval sheet for product specifications before ordering.

Continued from the preceding page.

Part Number	Temp. Char.	Rated Voltage (Vdc)	Capacitance (pF)	Dimensions LxW (mm)	Dimension T (mm)	Lead Space F (mm)	Lead Style Code Bulk	Lead Style Code Taping (1)	Lead Style Code Taping (2)
RPE5C2A7R0D2□□Z03□	C0G	100	7.0 ±0.5pF	5.0 x 3.5	2.5	2.5	P1	S1	S2
RPE5C2A7R0D2□□Z03□	C0G	100	7.0 ±0.5pF	5.0 x 3.5	2.5	5.0	K1	M1	M2
RPE5C2A8R0D2□□Z03□	C0G	100	8.0 ±0.5pF	5.0 x 3.5	2.5	2.5	P1	S1	S2
RPE5C2A8R0D2□□Z03□	C0G	100	8.0 ±0.5pF	5.0 x 3.5	2.5	5.0	K1	M1	M2
RPE5C2A9R0D2□□Z03□	C0G	100	9.0 ±0.5pF	5.0 x 3.5	2.5	2.5	P1	S1	S2
RPE5C2A9R0D2□□Z03□	C0G	100	9.0 ±0.5pF	5.0 x 3.5	2.5	5.0	K1	M1	M2
RPE5C2A100J2□□Z03□	C0G	100	10 ±5%	5.0 x 3.5	2.5	2.5	P1	S1	S2
RPE5C2A100J2□□Z03□	C0G	100	10 ±5%	5.0 x 3.5	2.5	5.0	K1	M1	M2
RPE5C2A120J2□□Z03□	C0G	100	12 ±5%	5.0 x 3.5	2.5	2.5	P1	S1	S2
RPE5C2A120J2□□Z03□	C0G	100	12 ±5%	5.0 x 3.5	2.5	5.0	K1	M1	M2
RPE5C2A150J2□□Z03□	C0G	100	15 ±5%	5.0 x 3.5	2.5	2.5	P1	S1	S2
RPE5C2A150J2□□Z03□	C0G	100	15 ±5%	5.0 x 3.5	2.5	5.0	K1	M1	M2
RPE5C2A180J2□□Z03□	C0G	100	18 ±5%	5.0 x 3.5	2.5	2.5	P1	S1	S2
RPE5C2A180J2□□Z03□	C0G	100	18 ±5%	5.0 x 3.5	2.5	5.0	K1	M1	M2
RPE5C2A220J2□□Z03□	C0G	100	22 ±5%	5.0 x 3.5	2.5	2.5	P1	S1	S2
RPE5C2A220J2□□Z03□	C0G	100	22 ±5%	5.0 x 3.5	2.5	5.0	K1	M1	M2
RPE5C2A270J2□□Z03□	C0G	100	27 ±5%	5.0 x 3.5	2.5	2.5	P1	S1	S2
RPE5C2A270J2□□Z03□	C0G	100	27 ±5%	5.0 x 3.5	2.5	5.0	K1	M1	M2
RPE5C2A330J2□□Z03□	C0G	100	33 ±5%	5.0 x 3.5	2.5	2.5	P1	S1	S2
RPE5C2A330J2□□Z03□	C0G	100	33 ±5%	5.0 x 3.5	2.5	5.0	K1	M1	M2
RPE5C2A390J2□□Z03□	C0G	100	39 ±5%	5.0 x 3.5	2.5	2.5	P1	S1	S2
RPE5C2A390J2□□Z03□	C0G	100	39 ±5%	5.0 x 3.5	2.5	5.0	K1	M1	M2
RPE5C2A470J2□□Z03□	C0G	100	47 ±5%	5.0 x 3.5	2.5	2.5	P1	S1	S2
RPE5C2A470J2□□Z03□	C0G	100	47 ±5%	5.0 x 3.5	2.5	5.0	K1	M1	M2
RPE5C2A560J2□□Z03□	C0G	100	56 ±5%	5.0 x 3.5	2.5	2.5	P1	S1	S2
RPE5C2A560J2□□Z03□	C0G	100	56 ±5%	5.0 x 3.5	2.5	5.0	K1	M1	M2
RPE5C2A680J2□□Z03□	C0G	100	68 ±5%	5.0 x 3.5	2.5	2.5	P1	S1	S2
RPE5C2A680J2□□Z03□	C0G	100	68 ±5%	5.0 x 3.5	2.5	5.0	K1	M1	M2
RPE5C2A820J2□□Z03□	C0G	100	82 ±5%	5.0 x 3.5	2.5	2.5	P1	S1	S2
RPE5C2A820J2□□Z03□	C0G	100	82 ±5%	5.0 x 3.5	2.5	5.0	K1	M1	M2
RPE5C2A101J2□□Z03□	C0G	100	100 ±5%	5.0 x 3.5	2.5	2.5	P1	S1	S2
RPE5C2A101J2□□Z03□	C0G	100	100 ±5%	5.0 x 3.5	2.5	5.0	K1	M1	M2
RPE5C2A121J2□□Z03□	C0G	100	120 ±5%	5.0 x 3.5	2.5	2.5	P1	S1	S2
RPE5C2A121J2□□Z03□	C0G	100	120 ±5%	5.0 x 3.5	2.5	5.0	K1	M1	M2
RPE5C2A151J2□□Z03□	C0G	100	150 ±5%	5.0 x 3.5	2.5	2.5	P1	S1	S2
RPE5C2A151J2□□Z03□	C0G	100	150 ±5%	5.0 x 3.5	2.5	5.0	K1	M1	M2
RPE5C2A181J2□□Z03□	C0G	100	180 ±5%	5.0 x 3.5	2.5	2.5	P1	S1	S2
RPE5C2A181J2□□Z03□	C0G	100	180 ±5%	5.0 x 3.5	2.5	5.0	K1	M1	M2
RPE5C2A221J2□□Z03□	C0G	100	220 ±5%	5.0 x 3.5	2.5	2.5	P1	S1	S2
RPE5C2A221J2□□Z03□	C0G	100	220 ±5%	5.0 x 3.5	2.5	5.0	K1	M1	M2
RPE5C2A271J2□□Z03□	C0G	100	270 ±5%	5.0 x 3.5	2.5	2.5	P1	S1	S2
RPE5C2A271J2□□Z03□	C0G	100	270 ±5%	5.0 x 3.5	2.5	5.0	K1	M1	M2
RPE5C2A331J2□□Z03□	C0G	100	330 ±5%	5.0 x 3.5	2.5	2.5	P1	S1	S2
RPE5C2A331J2□□Z03□	C0G	100	330 ±5%	5.0 x 3.5	2.5	5.0	K1	M1	M2
RPE5C2A391J2□□Z03□	C0G	100	390 ±5%	5.0 x 3.5	2.5	2.5	P1	S1	S2
RPE5C2A391J2□□Z03□	C0G	100	390 ±5%	5.0 x 3.5	2.5	5.0	K1	M1	M2
RPE5C2A471J2□□Z03□	C0G	100	470 ±5%	5.0 x 3.5	2.5	2.5	P1	S1	S2
RPE5C2A471J2□□Z03□	C0G	100	470 ±5%	5.0 x 3.5	2.5	5.0	K1	M1	M2
RPE5C2A561J2□□B03□	C0G	100	560 ±5%	5.0 x 3.5	2.5	2.5	P1	S1	S2
RPE5C2A561J2□□B03□	C0G	100	560 ±5%	5.0 x 3.5	2.5	5.0	K1	M1	M2
RPE5C2A681J2□□B03□	C0G	100	680 ±5%	5.0 x 3.5	2.5	2.5	P1	S1	S2
RPE5C2A681J2□□B03□	C0G	100	680 ±5%	5.0 x 3.5	2.5	5.0	K1	M1	M2
RPE5C2A821J2□□B03□	C0G	100	820 ±5%	5.0 x 3.5	3.15	2.5	P1	S1	S2
RPE5C2A821J2□□B03□	C0G	100	820 ±5%	5.0 x 3.5	3.15	5.0	K1	M1	M2
RPE5C2A102J2□□B03□	C0G	100	1000 ±5%	5.0 x 3.5	3.15	2.5	P1	S1	S2
RPE5C2A102J2□□B03□	C0G	100	1000 ±5%	5.0 x 3.5	3.15	5.0	K1	M1	M2
RPE5C2A122J2□□D03□	C0G	100	1200 ±5%	5.0 x 3.5	3.15	2.5	P1	S1	S2

Continued on the following page. 

△Note • This PDF catalog is downloaded from the website of Murata Manufacturing co., Ltd. Therefore, it's specifications are subject to change or our products in it may be discontinued without advance notice. Please check with our sales representatives or product engineers before ordering.
 • This PDF catalog has only typical specifications because there is no space for detailed specifications. Therefore, please approve our product specifications or transact the approval sheet for product specifications before ordering.

Continued from the preceding page.

Part Number	Temp. Char.	Rated Voltage (Vdc)	Capacitance (pF)	Dimensions LxW (mm)	Dimension T (mm)	Lead Space F (mm)	Lead Style Code Bulk	Lead Style Code Taping (1)	Lead Style Code Taping (2)
RPE5C2A122J2□□D03□	C0G	100	1200 ±5%	5.0 x 3.5	3.15	5.0	K1	M1	M2
RPE5C2A152J2□□D03□	C0G	100	1500 ±5%	5.0 x 3.5	3.15	2.5	P1	S1	S2
RPE5C2A152J2□□D03□	C0G	100	1500 ±5%	5.0 x 3.5	3.15	5.0	K1	M1	M2
RPE5C2A182J2□□D03□	C0G	100	1800 ±5%	5.0 x 3.5	3.15	2.5	P1	S1	S2
RPE5C2A182J2□□D03□	C0G	100	1800 ±5%	5.0 x 3.5	3.15	5.0	K1	M1	M2
RPE5C2A222J2□□D03□	C0G	100	2200 ±5%	5.0 x 3.5	3.15	2.5	P1	S1	S2
RPE5C2A222J2□□D03□	C0G	100	2200 ±5%	5.0 x 3.5	3.15	5.0	K1	M1	M2
RPE5C2A272J3□□D03□	C0G	100	2700 ±5%	5.0 x 4.5	3.15	2.5	P1	S1	S2
RPE5C2A272J3□□D03□	C0G	100	2700 ±5%	5.0 x 4.5	3.15	5.0	K1	M1	M2
RPE5C2A332J3□□D03□	C0G	100	3300 ±5%	5.0 x 4.5	3.15	2.5	P1	S1	S2
RPE5C2A332J3□□D03□	C0G	100	3300 ±5%	5.0 x 4.5	3.15	5.0	K1	M1	M2
RPE5C2A392J3□□D03□	C0G	100	3900 ±5%	5.0 x 4.5	3.15	2.5	P1	S1	S2
RPE5C2A392J3□□D03□	C0G	100	3900 ±5%	5.0 x 4.5	3.15	5.0	K1	M1	M2
RPE5C2A472J4□□X03□	C0G	100	4700 ±5%	7.5 x 5.0	2.5	5.0	K1	M1	M2
RPE5C2A562J4□□F03□	C0G	100	5600 ±5%	7.5 x 5.0	3.15	5.0	K1	M1	M2
RPE5C2A682J4□□F03□	C0G	100	6800 ±5%	7.5 x 5.0	3.15	5.0	K1	M1	M2
RPE5C2A822J5□□X03□	C0G	100	8200 ±5%	7.5 x 7.5	4.0	5.0	B1	E1	E2
RPE5C2A103J5□□X03□	C0G	100	10000 ±5%	7.5 x 7.5	4.0	5.0	B1	E1	E2
RPE5C2A123J5□□X03□	C0G	100	12000 ±5%	7.5 x 7.5	4.0	5.0	B1	E1	E2
RPE5C2A153J6□□X13□	C0G	100	15000 ±5%	10.0 x 10.0	4.0	5.0	B1	E1	E2
RPE5C2A183J6□□X13□	C0G	100	18000 ±5%	10.0 x 10.0	4.0	5.0	B1	E1	E2
RPE5C2A223J6□□X03□	C0G	100	22000 ±5%	10.0 x 10.0	4.0	5.0	B1	E1	E2
RPE5C2A273J6□□X03□	C0G	100	27000 ±5%	10.0 x 10.0	4.0	5.0	B1	E1	E2
RPE5C2A333J6□□F03□	C0G	100	33000 ±5%	10.0 x 10.0	4.0	5.0	B1	E1	E2
RPE5C2A393J7□□X03□	C0G	100	39000 ±5%	12.5 x 12.5	5.0	10.0	C1	-	-
RPE5C2A473J7□□F03□	C0G	100	47000 ±5%	12.5 x 12.5	5.0	10.0	C1	-	-
RPE5C2A563J7□□F03□	C0G	100	56000 ±5%	12.5 x 12.5	5.0	10.0	C1	-	-

Two blank columns are filled with the lead style code. Please refer to the 3 columns on the right for the appropriate code.
 The last blank column is filled with the packaging code. (B: bulk, A: ammo pack)

High Dielectric Constant Type, X7R Characteristics

Part Number	Temp. Char.	Rated Voltage (Vdc)	Capacitance	Dimensions LxW (mm)	Dimension T (mm)	Lead Space F (mm)	Lead Style Code Bulk	Lead Style Code Taping (1)	Lead Style Code Taping (2)
RPER71E474K2□□A03□	X7R	25	0.47μF ±10%	5.0 x 3.5	3.15	5.0	K1	M1	M2
RPER71E684K2□□C03□	X7R	25	0.68μF ±10%	5.0 x 3.5	3.15	5.0	K1	M1	M2
RPER71E105K2□□C03□	X7R	25	1.0μF ±10%	5.0 x 3.5	3.15	5.0	K1	M1	M2
RPER71E155K3□□C07□	X7R	25	1.5μF ±10%	5.0 x 4.5	3.15	5.0	K1	M1	M2
RPER71E225K3□□C07□	X7R	25	2.2μF ±10%	5.0 x 4.5	3.15	5.0	K1	M1	M2
RPER71H221K2□□A03□	X7R	50	220pF ±10%	5.0 x 3.5	2.5	2.5	P1	S1	S2
RPER71H221K2□□A03□	X7R	50	220pF ±10%	5.0 x 3.5	2.5	5.0	K1	M1	M2
RPER71H331K2□□A03□	X7R	50	330pF ±10%	5.0 x 3.5	2.5	2.5	P1	S1	S2
RPER71H331K2□□A03□	X7R	50	330pF ±10%	5.0 x 3.5	2.5	5.0	K1	M1	M2
RPER71H471K2□□A03□	X7R	50	470pF ±10%	5.0 x 3.5	2.5	2.5	P1	S1	S2
RPER71H471K2□□A03□	X7R	50	470pF ±10%	5.0 x 3.5	2.5	5.0	K1	M1	M2
RPER71H681K2□□A03□	X7R	50	680pF ±10%	5.0 x 3.5	2.5	2.5	P1	S1	S2
RPER71H681K2□□A03□	X7R	50	680pF ±10%	5.0 x 3.5	2.5	5.0	K1	M1	M2
RPER71H102K2□□A03□	X7R	50	1000pF ±10%	5.0 x 3.5	2.5	2.5	P1	S1	S2
RPER71H102K2□□A03□	X7R	50	1000pF ±10%	5.0 x 3.5	2.5	5.0	K1	M1	M2
RPER71H152K2□□A03□	X7R	50	1500pF ±10%	5.0 x 3.5	2.5	2.5	P1	S1	S2
RPER71H152K2□□A03□	X7R	50	1500pF ±10%	5.0 x 3.5	2.5	5.0	K1	M1	M2
RPER71H222K2□□A03□	X7R	50	2200pF ±10%	5.0 x 3.5	2.5	2.5	P1	S1	S2
RPER71H222K2□□A03□	X7R	50	2200pF ±10%	5.0 x 3.5	2.5	5.0	K1	M1	M2
RPER71H332K2□□A03□	X7R	50	3300pF ±10%	5.0 x 3.5	2.5	2.5	P1	S1	S2
RPER71H332K2□□A03□	X7R	50	3300pF ±10%	5.0 x 3.5	2.5	5.0	K1	M1	M2
RPER71H472K2□□A03□	X7R	50	4700pF ±10%	5.0 x 3.5	2.5	2.5	P1	S1	S2

Continued on the following page. ↗

△Note • This PDF catalog is downloaded from the website of Murata Manufacturing co., Ltd. Therefore, it's specifications are subject to change or our products in it may be discontinued without advance notice. Please check with our sales representatives or product engineers before ordering.
 • This PDF catalog has only typical specifications because there is no space for detailed specifications. Therefore, please approve our product specifications or transact the approval sheet for product specifications before ordering.

Continued from the preceding page.

Part Number	Temp. Char.	Rated Voltage (Vdc)	Capacitance	Dimensions LxW (mm)	Dimension T (mm)	Lead Space F (mm)	Lead Style Code Bulk	Lead Style Code Taping (1)	Lead Style Code Taping (2)
RPER71H472K2□□A03□	X7R	50	4700pF ±10%	5.0 x 3.5	2.5	5.0	K1	M1	M2
RPER71H682K2□□A03□	X7R	50	6800pF ±10%	5.0 x 3.5	2.5	2.5	P1	S1	S2
RPER71H682K2□□A03□	X7R	50	6800pF ±10%	5.0 x 3.5	2.5	5.0	K1	M1	M2
RPER71H103K2□□A03□	X7R	50	10000pF ±10%	5.0 x 3.5	2.5	2.5	P1	S1	S2
RPER71H103K2□□A03□	X7R	50	10000pF ±10%	5.0 x 3.5	2.5	5.0	K1	M1	M2
RPER71H153K2□□A03□	X7R	50	15000pF ±10%	5.0 x 3.5	2.5	2.5	P1	S1	S2
RPER71H153K2□□A03□	X7R	50	15000pF ±10%	5.0 x 3.5	2.5	5.0	K1	M1	M2
RPER71H223K2□□A03□	X7R	50	22000pF ±10%	5.0 x 3.5	2.5	2.5	P1	S1	S2
RPER71H223K2□□A03□	X7R	50	22000pF ±10%	5.0 x 3.5	2.5	5.0	K1	M1	M2
RPER71H333K2□□A03□	X7R	50	33000pF ±10%	5.0 x 3.5	3.15	2.5	P1	S1	S2
RPER71H333K2□□A03□	X7R	50	33000pF ±10%	5.0 x 3.5	3.15	5.0	K1	M1	M2
RPER71H473K2□□A03□	X7R	50	47000pF ±10%	5.0 x 3.5	3.15	2.5	P1	S1	S2
RPER71H473K2□□A03□	X7R	50	47000pF ±10%	5.0 x 3.5	3.15	5.0	K1	M1	M2
RPER71H683K2□□A03□	X7R	50	68000pF ±10%	5.0 x 3.5	3.15	2.5	P1	S1	S2
RPER71H683K2□□A03□	X7R	50	68000pF ±10%	5.0 x 3.5	3.15	5.0	K1	M1	M2
RPER71H104K2□□A03□	X7R	50	0.10μF ±10%	5.0 x 3.5	3.15	2.5	P1	S1	S2
RPER71H104K2□□A03□	X7R	50	0.10μF ±10%	5.0 x 3.5	3.15	5.0	K1	M1	M2
RPER71H154K2□□C03□	X7R	50	0.15μF ±10%	5.0 x 3.5	3.15	2.5	P1	S1	S2
RPER71H154K2□□C03□	X7R	50	0.15μF ±10%	5.0 x 3.5	3.15	5.0	K1	M1	M2
RPER71H224K2□□C03□	X7R	50	0.22μF ±10%	5.0 x 3.5	3.15	2.5	P1	S1	S2
RPER71H224K2□□C03□	X7R	50	0.22μF ±10%	5.0 x 3.5	3.15	5.0	K1	M1	M2
RPER71H334K2□□C03□	X7R	50	0.33μF ±10%	5.0 x 3.5	2.5	2.5	P1	S1	S2
RPER71H334K2□□C03□	X7R	50	0.33μF ±10%	5.0 x 3.5	2.5	5.0	K1	M1	M2
RPER71H474K2□□C03□	X7R	50	0.47μF ±10%	5.0 x 3.5	3.15	2.5	P1	S1	S2
RPER71H474K2□□C03□	X7R	50	0.47μF ±10%	5.0 x 3.5	3.15	5.0	K1	M1	M2
RPER71H684K3□□C03□	X7R	50	0.68μF ±10%	5.0 x 4.5	3.15	2.5	P1	S1	S2
RPER71H684K3□□C03□	X7R	50	0.68μF ±10%	5.0 x 4.5	3.15	5.0	K1	M1	M2
RPER71H105K3□□C07□	X7R	50	1.0μF ±10%	5.0 x 4.5	3.15	2.5	P1	S1	S2
RPER71H105K3□□C07□	X7R	50	1.0μF ±10%	5.0 x 4.5	3.15	5.0	K1	M1	M2
RPER71H155K8□□C03□	X7R	50	1.5μF ±10%	7.5 x 5.5	4.0	5.0	K1	M1	M2
RPER71H225K8□□C03□	X7R	50	2.2μF ±10%	7.5 x 5.5	4.0	5.0	K1	M1	M2
RPER71H335K5□□C03□	X7R	50	3.3μF ±10%	7.5 x 7.5	5.0	5.0	B1	E1	E2
RPER71H475K5□□C03□	X7R	50	4.7μF ±10%	7.5 x 7.5	4.0	5.0	B1	E1	E2
RPER72A221K2□□B03□	X7R	100	220pF ±10%	5.0 x 3.5	2.5	2.5	P1	S1	S2
RPER72A221K2□□B03□	X7R	100	220pF ±10%	5.0 x 3.5	2.5	5.0	K1	M1	M2
RPER72A331K2□□B03□	X7R	100	330pF ±10%	5.0 x 3.5	2.5	2.5	P1	S1	S2
RPER72A331K2□□B03□	X7R	100	330pF ±10%	5.0 x 3.5	2.5	5.0	K1	M1	M2
RPER72A471K2□□B03□	X7R	100	470pF ±10%	5.0 x 3.5	2.5	2.5	P1	S1	S2
RPER72A471K2□□B03□	X7R	100	470pF ±10%	5.0 x 3.5	2.5	5.0	K1	M1	M2
RPER72A681K2□□B03□	X7R	100	680pF ±10%	5.0 x 3.5	2.5	2.5	P1	S1	S2
RPER72A681K2□□B03□	X7R	100	680pF ±10%	5.0 x 3.5	2.5	5.0	K1	M1	M2
RPER72A102K2□□A03□	X7R	100	1000pF ±10%	5.0 x 3.5	2.5	2.5	P1	S1	S2
RPER72A102K2□□A03□	X7R	100	1000pF ±10%	5.0 x 3.5	2.5	5.0	K1	M1	M2
RPER72A152K2□□A03□	X7R	100	1500pF ±10%	5.0 x 3.5	2.5	2.5	P1	S1	S2
RPER72A152K2□□A03□	X7R	100	1500pF ±10%	5.0 x 3.5	2.5	5.0	K1	M1	M2
RPER72A222K2□□A03□	X7R	100	2200pF ±10%	5.0 x 3.5	2.5	2.5	P1	S1	S2
RPER72A222K2□□A03□	X7R	100	2200pF ±10%	5.0 x 3.5	2.5	5.0	K1	M1	M2
RPER72A332K2□□A03□	X7R	100	3300pF ±10%	5.0 x 3.5	2.5	2.5	P1	S1	S2
RPER72A332K2□□A03□	X7R	100	3300pF ±10%	5.0 x 3.5	2.5	5.0	K1	M1	M2
RPER72A472K2□□A03□	X7R	100	4700pF ±10%	5.0 x 3.5	2.5	2.5	P1	S1	S2
RPER72A472K2□□A03□	X7R	100	4700pF ±10%	5.0 x 3.5	2.5	5.0	K1	M1	M2
RPER72A682K2□□A03□	X7R	100	6800pF ±10%	5.0 x 3.5	2.5	2.5	P1	S1	S2
RPER72A682K2□□A03□	X7R	100	6800pF ±10%	5.0 x 3.5	2.5	5.0	K1	M1	M2
RPER72A103K2□□A03□	X7R	100	10000pF ±10%	5.0 x 3.5	3.15	2.5	P1	S1	S2
RPER72A103K2□□A03□	X7R	100	10000pF ±10%	5.0 x 3.5	3.15	5.0	K1	M1	M2
RPER72A153K2□□A03□	X7R	100	15000pF ±10%	5.0 x 3.5	3.15	2.5	P1	S1	S2
RPER72A153K2□□A03□	X7R	100	15000pF ±10%	5.0 x 3.5	3.15	5.0	K1	M1	M2

Continued on the following page. 

△Note • This PDF catalog is downloaded from the website of Murata Manufacturing co., Ltd. Therefore, it's specifications are subject to change or our products in it may be discontinued without advance notice. Please check with our sales representatives or product engineers before ordering.
 • This PDF catalog has only typical specifications because there is no space for detailed specifications. Therefore, please approve our product specifications or transact the approval sheet for product specifications before ordering.

Continued from the preceding page.

Part Number	Temp. Char.	Rated Voltage (Vdc)	Capacitance	Dimensions LxW (mm)	Dimension T (mm)	Lead Space F (mm)	Lead Style Code Bulk	Lead Style Code Taping (1)	Lead Style Code Taping (2)
RPER72A223K2□□A03□	X7R	100	22000pF ±10%	5.0 x 3.5	3.15	2.5	P1	S1	S2
RPER72A223K2□□A03□	X7R	100	22000pF ±10%	5.0 x 3.5	3.15	5.0	K1	M1	M2
RPER72A333K2□□C03□	X7R	100	33000pF ±10%	5.0 x 3.5	3.15	2.5	P1	S1	S2
RPER72A333K2□□C03□	X7R	100	33000pF ±10%	5.0 x 3.5	3.15	5.0	K1	M1	M2
RPER72A473K3□□C07□	X7R	100	47000pF ±10%	5.0 x 4.5	3.15	2.5	P1	S1	S2
RPER72A473K3□□C07□	X7R	100	47000pF ±10%	5.0 x 4.5	3.15	5.0	K1	M1	M2
RPER72A683K3□□C07□	X7R	100	68000pF ±10%	5.0 x 4.5	3.15	2.5	P1	S1	S2
RPER72A683K3□□C07□	X7R	100	68000pF ±10%	5.0 x 4.5	3.15	5.0	K1	M1	M2
RPER72A104K3□□C07□	X7R	100	0.10μF ±10%	5.0 x 4.5	3.15	2.5	P1	S1	S2
RPER72A104K3□□C07□	X7R	100	0.10μF ±10%	5.0 x 4.5	3.15	5.0	K1	M1	M2
RPER72A154K8□□C03□	X7R	100	0.15μF ±10%	7.5 x 5.5	4.0	5.0	K1	M1	M2
RPER72A224K8□□C03□	X7R	100	0.22μF ±10%	7.5 x 5.5	4.0	5.0	K1	M1	M2
RPER72A334K5□□C03□	X7R	100	0.33μF ±10%	7.5 x 7.5	4.0	5.0	B1	E1	E2
RPER72A474K8□□C03□	X7R	100	0.47μF ±10%	7.5 x 5.5	4.0	5.0	K1	M1	M2
RPER72A684K6□□F14□	X7R	100	0.68μF ±10%	10.0 x 10.0	4.0	5.0	B1	E1	E2
RPER72A105K5□□C03□	X7R	100	1.0μF ±10%	7.5 x 7.5	4.0	5.0	B1	E1	E2
RPER72A155K7□□F03□	X7R	100	1.5μF ±10%	12.5 x 12.5	5.0	10.0	C1	-	-
RPER72A225K7□□F03□	X7R	100	2.2μF ±10%	12.5 x 12.5	5.0	10.0	C1	-	-

Two blank columns are filled with the lead style code. Please refer to the 3 columns on the right for the appropriate code.
 The last blank column is filled with the packaging code. (B: bulk, A: ammo pack)

High Dielectric Constant Type, Z5U Characteristics

Part Number	Temp. Char.	Rated Voltage (Vdc)	Capacitance	Dimensions LxW (mm)	Dimension T (mm)	Lead Space F (mm)	Lead Style Code Bulk	Lead Style Code Taping (1)	Lead Style Code Taping (2)
RPEE41E105M3□□C03□	Z5U	25	1.0μF ±20%	5.0 x 4.5	2.5	2.5	P1	S1	S2
RPEE41E105M3□□C03□	Z5U	25	1.0μF ±20%	5.0 x 4.5	2.5	5.0	K1	M1	M2
RPEE41H102M2□□A03□	Z5U	50	1000pF ±20%	5.0 x 3.5	2.5	2.5	P1	S1	S2
RPEE41H102M2□□A03□	Z5U	50	1000pF ±20%	5.0 x 3.5	2.5	5.0	K1	M1	M2
RPEE41H222M2□□A03□	Z5U	50	2200pF ±20%	5.0 x 3.5	2.5	2.5	P1	S1	S2
RPEE41H222M2□□A03□	Z5U	50	2200pF ±20%	5.0 x 3.5	2.5	5.0	K1	M1	M2
RPEE41H472M2□□A03□	Z5U	50	4700pF ±20%	5.0 x 3.5	2.5	2.5	P1	S1	S2
RPEE41H472M2□□A03□	Z5U	50	4700pF ±20%	5.0 x 3.5	2.5	5.0	K1	M1	M2
RPEE41H103M2□□A03□	Z5U	50	10000pF ±20%	5.0 x 3.5	2.5	2.5	P1	S1	S2
RPEE41H103M2□□A03□	Z5U	50	10000pF ±20%	5.0 x 3.5	2.5	5.0	K1	M1	M2
RPEE41H223M2□□A03□	Z5U	50	22000pF ±20%	5.0 x 3.5	2.5	2.5	P1	S1	S2
RPEE41H223M2□□A03□	Z5U	50	22000pF ±20%	5.0 x 3.5	2.5	5.0	K1	M1	M2
RPEE41H473M2□□A03□	Z5U	50	47000pF ±20%	5.0 x 3.5	2.5	2.5	P1	S1	S2
RPEE41H473M2□□A03□	Z5U	50	47000pF ±20%	5.0 x 3.5	2.5	5.0	K1	M1	M2
RPEE41H104M2□□A03□	Z5U	50	0.10μF ±20%	5.0 x 3.5	2.5	2.5	P1	S1	S2
RPEE41H104M2□□A03□	Z5U	50	0.10μF ±20%	5.0 x 3.5	2.5	5.0	K1	M1	M2
RPEE41H224M3□□C03□	Z5U	50	0.22μF ±20%	5.0 x 4.5	2.5	2.5	P1	S1	S2
RPEE41H224M3□□C03□	Z5U	50	0.22μF ±20%	5.0 x 4.5	2.5	5.0	K1	M1	M2
RPEE41H474M3□□C03□	Z5U	50	0.47μF ±20%	5.0 x 4.5	3.15	2.5	P1	S1	S2
RPEE41H474M3□□C03□	Z5U	50	0.47μF ±20%	5.0 x 4.5	3.15	5.0	K1	M1	M2
RPEE41H105M4□□E12□	Z5U	50	1.0μF ±20%	7.5 x 5.0	3.15	5.0	K1	M1	M2
RPEE41H225M6□□F14□	Z5U	50	2.2μF ±20%	10.0 x 10.0	4.0	5.0	B1	E1	E2
RPEE41H475M7□□F03□	Z5U	50	4.7μF ±20%	12.5 x 12.5	5.0	10.0	C1	-	-
RPEE42A102M2□□B03□	Z5U	100	1000pF ±20%	5.0 x 3.5	2.5	2.5	P1	S1	S2
RPEE42A102M2□□B03□	Z5U	100	1000pF ±20%	5.0 x 3.5	2.5	5.0	K1	M1	M2
RPEE42A222M2□□B03□	Z5U	100	2200pF ±20%	5.0 x 3.5	2.5	2.5	P1	S1	S2
RPEE42A222M2□□B03□	Z5U	100	2200pF ±20%	5.0 x 3.5	2.5	5.0	K1	M1	M2
RPEE42A472M2□□B03□	Z5U	100	4700pF ±20%	5.0 x 3.5	2.5	2.5	P1	S1	S2
RPEE42A472M2□□B03□	Z5U	100	4700pF ±20%	5.0 x 3.5	2.5	5.0	K1	M1	M2
RPEE42A103M2□□B03□	Z5U	100	10000pF ±20%	5.0 x 3.5	2.5	2.5	P1	S1	S2
RPEE42A103M2□□B03□	Z5U	100	10000pF ±20%	5.0 x 3.5	2.5	5.0	K1	M1	M2

Continued on the following page. ↗

△Note • This PDF catalog is downloaded from the website of Murata Manufacturing co., Ltd. Therefore, it's specifications are subject to change or our products in it may be discontinued without advance notice. Please check with our sales representatives or product engineers before ordering.
 • This PDF catalog has only typical specifications because there is no space for detailed specifications. Therefore, please approve our product specifications or transact the approval sheet for product specifications before ordering.

Continued from the preceding page.

Part Number	Temp. Char.	Rated Voltage (Vdc)	Capacitance	Dimensions LxW (mm)	Dimension T (mm)	Lead Space F (mm)	Lead Style Code Bulk	Lead Style Code Taping (1)	Lead Style Code Taping (2)
RPEE42A223M2□□D03□	Z5U	100	22000pF ±20%	5.0 x 3.5	2.5	2.5	P1	S1	S2
RPEE42A223M2□□D03□	Z5U	100	22000pF ±20%	5.0 x 3.5	2.5	5.0	K1	M1	M2
RPEE42A473M3□□D03□	Z5U	100	47000pF ±20%	5.0 x 4.5	2.5	2.5	P1	S1	S2
RPEE42A473M3□□D03□	Z5U	100	47000pF ±20%	5.0 x 4.5	2.5	5.0	K1	M1	M2
RPEE42A104M3□□C03□	Z5U	100	0.10μF ±20%	5.0 x 4.5	3.15	2.5	P1	S1	S2
RPEE42A104M3□□C03□	Z5U	100	0.10μF ±20%	5.0 x 4.5	3.15	5.0	K1	M1	M2

Two blank columns are filled with the lead style code. Please refer to the 3 columns on the right for the appropriate code.
 The last blank column is filled with the packaging code. (B: bulk, A: ammo pack)

High Dielectric Constant Type, Y5V Characteristics

Part Number	Temp. Char.	Rated Voltage (Vdc)	Capacitance	Dimensions LxW (mm)	Dimension T (mm)	Lead Space F (mm)	Lead Style Code Bulk	Lead Style Code Taping (1)	Lead Style Code Taping (2)
RPEF51E105Z3□□C03□	Y5V	25	1.0μF +80/-20%	5.0 x 4.5	2.5	2.5	P1	S1	S2
RPEF51E105Z3□□C03□	Y5V	25	1.0μF +80/-20%	5.0 x 4.5	2.5	5.0	K1	M1	M2
RPEF51H102Z2□□A03□	Y5V	50	1000pF +80/-20%	5.0 x 3.5	2.5	2.5	P1	S1	S2
RPEF51H102Z2□□A03□	Y5V	50	1000pF +80/-20%	5.0 x 3.5	2.5	5.0	K1	M1	M2
RPEF51H222Z2□□A03□	Y5V	50	2200pF +80/-20%	5.0 x 3.5	2.5	2.5	P1	S1	S2
RPEF51H222Z2□□A03□	Y5V	50	2200pF +80/-20%	5.0 x 3.5	2.5	5.0	K1	M1	M2
RPEF51H472Z2□□A03□	Y5V	50	4700pF +80/-20%	5.0 x 3.5	2.5	2.5	P1	S1	S2
RPEF51H472Z2□□A03□	Y5V	50	4700pF +80/-20%	5.0 x 3.5	2.5	5.0	K1	M1	M2
RPEF51H103Z2□□A03□	Y5V	50	10000pF +80/-20%	5.0 x 3.5	2.5	2.5	P1	S1	S2
RPEF51H103Z2□□A03□	Y5V	50	10000pF +80/-20%	5.0 x 3.5	2.5	5.0	K1	M1	M2
RPEF51H223Z2□□A03□	Y5V	50	22000pF +80/-20%	5.0 x 3.5	2.5	2.5	P1	S1	S2
RPEF51H223Z2□□A03□	Y5V	50	22000pF +80/-20%	5.0 x 3.5	2.5	5.0	K1	M1	M2
RPEF51H473Z2□□A03□	Y5V	50	47000pF +80/-20%	5.0 x 3.5	2.5	2.5	P1	S1	S2
RPEF51H473Z2□□A03□	Y5V	50	47000pF +80/-20%	5.0 x 3.5	2.5	5.0	K1	M1	M2
RPEF51H104Z2□□A03□	Y5V	50	0.10μF +80/-20%	5.0 x 3.5	2.5	2.5	P1	S1	S2
RPEF51H104Z2□□A03□	Y5V	50	0.10μF +80/-20%	5.0 x 3.5	2.5	5.0	K1	M1	M2
RPEF51H224Z2□□A03□	Y5V	50	0.22μF +80/-20%	5.0 x 3.5	3.15	2.5	P1	S1	S2
RPEF51H224Z2□□A03□	Y5V	50	0.22μF +80/-20%	5.0 x 3.5	3.15	5.0	K1	M1	M2
RPEF51H474Z2□□C03□	Y5V	50	0.47μF +80/-20%	5.0 x 3.5	3.15	2.5	P1	S1	S2
RPEF51H474Z2□□C03□	Y5V	50	0.47μF +80/-20%	5.0 x 3.5	3.15	5.0	K1	M1	M2
RPEF51H105Z4□□E12□	Y5V	50	1.0μF +80/-20%	7.5 x 5.0	2.5	5.0	K1	M1	M2
RPEF51H225Z6□□F14□	Y5V	50	2.2μF +80/-20%	10.0 x 10.0	4.0	5.0	B1	E1	E2
RPEF51H475Z6□□F03□	Y5V	50	4.7μF +80/-20%	10.0 x 10.0	4.0	5.0	B1	E1	E2
RPEF52A102Z2□□B03□	Y5V	100	1000pF +80/-20%	5.0 x 3.5	2.5	2.5	P1	S1	S2
RPEF52A102Z2□□B03□	Y5V	100	1000pF +80/-20%	5.0 x 3.5	2.5	5.0	K1	M1	M2
RPEF52A222Z2□□B03□	Y5V	100	2200pF +80/-20%	5.0 x 3.5	2.5	2.5	P1	S1	S2
RPEF52A222Z2□□B03□	Y5V	100	2200pF +80/-20%	5.0 x 3.5	2.5	5.0	K1	M1	M2
RPEF52A472Z2□□B03□	Y5V	100	4700pF +80/-20%	5.0 x 3.5	2.5	2.5	P1	S1	S2
RPEF52A472Z2□□B03□	Y5V	100	4700pF +80/-20%	5.0 x 3.5	2.5	5.0	K1	M1	M2
RPEF52A103Z2□□B03□	Y5V	100	10000pF +80/-20%	5.0 x 3.5	2.5	2.5	P1	S1	S2
RPEF52A103Z2□□B03□	Y5V	100	10000pF +80/-20%	5.0 x 3.5	2.5	5.0	K1	M1	M2
RPEF52A223Z2□□D03□	Y5V	100	22000pF +80/-20%	5.0 x 3.5	2.5	2.5	P1	S1	S2
RPEF52A223Z2□□D03□	Y5V	100	22000pF +80/-20%	5.0 x 3.5	2.5	5.0	K1	M1	M2
RPEF52A473Z3□□D03□	Y5V	100	47000pF +80/-20%	5.0 x 4.5	2.5	2.5	P1	S1	S2
RPEF52A473Z3□□D03□	Y5V	100	47000pF +80/-20%	5.0 x 4.5	2.5	5.0	K1	M1	M2
RPEF52A104Z4□□F03□	Y5V	100	0.10μF +80/-20%	7.5 x 5.0	2.5	5.0	K1	M1	M2

Two blank columns are filled with the lead style code. Please refer to the 3 columns on the right for the appropriate code.
 The last blank column is filled with the packaging code. (B: bulk, A: ammo pack)

Small Size, Temperature Compensating Type, C0G Characteristics

Part Number	Temp. Char.	Rated Voltage (Vdc)	Capacitance (pF)	Dimensions LxW (mm)	Dimension T (mm)	Lead Space F (mm)
RPE5C1HR50C1A1D03B	C0G	50	0.5 ±0.25pF	3.5 x 3.0	2.5	2.5
RPE5C1H1R0C1A1D03B	C0G	50	1.0 ±0.25pF	3.5 x 3.0	2.5	2.5
RPE5C1H2R0C1A1D03B	C0G	50	2.0 ±0.25pF	3.5 x 3.0	2.5	2.5
RPE5C1H3R0C1A1D03B	C0G	50	3.0 ±0.25pF	3.5 x 3.0	2.5	2.5
RPE5C1H4R0C1A1D03B	C0G	50	4.0 ±0.25pF	3.5 x 3.0	2.5	2.5
RPE5C1H5R0C1A1D03B	C0G	50	5.0 ±0.25pF	3.5 x 3.0	2.5	2.5
RPE5C1H6R0D1A1D03B	C0G	50	6.0 ±0.5pF	3.5 x 3.0	2.5	2.5
RPE5C1H7R0D1A1Y03B	C0G	50	7.0 ±0.5pF	3.5 x 3.0	2.5	2.5
RPE5C1H8R0D1A1Y03B	C0G	50	8.0 ±0.5pF	3.5 x 3.0	2.5	2.5
RPE5C1H9R0D1A1Y03B	C0G	50	9.0 ±0.5pF	3.5 x 3.0	2.5	2.5
RPE5C1H100J1A1Y03B	C0G	50	10 ±5%	3.5 x 3.0	2.5	2.5
RPE5C1H120J1A1Y03B	C0G	50	12 ±5%	3.5 x 3.0	2.5	2.5
RPE5C1H150J1A1Y03B	C0G	50	15 ±5%	3.5 x 3.0	2.5	2.5
RPE5C1H180J1A1Y03B	C0G	50	18 ±5%	3.5 x 3.0	2.5	2.5
RPE5C1H220J1A1Y03B	C0G	50	22 ±5%	3.5 x 3.0	2.5	2.5
RPE5C1H270J1A1Y03B	C0G	50	27 ±5%	3.5 x 3.0	2.5	2.5
RPE5C1H330J1A1Y03B	C0G	50	33 ±5%	3.5 x 3.0	2.5	2.5
RPE5C1H390J1A1Y03B	C0G	50	39 ±5%	3.5 x 3.0	2.5	2.5
RPE5C1H470J1A1Y03B	C0G	50	47 ±5%	3.5 x 3.0	2.5	2.5
RPE5C1H560J1A1Y03B	C0G	50	56 ±5%	3.5 x 3.0	2.5	2.5
RPE5C1H680J1A1Y03B	C0G	50	68 ±5%	3.5 x 3.0	2.5	2.5
RPE5C1H820J1A1Y03B	C0G	50	82 ±5%	3.5 x 3.0	2.5	2.5
RPE5C1H101J1A1C03B	C0G	50	100 ±5%	3.5 x 3.0	2.5	2.5
RPE5C1H121J1A1C03B	C0G	50	120 ±5%	3.5 x 3.0	2.5	2.5
RPE5C1H151J1A1C03B	C0G	50	150 ±5%	3.5 x 3.0	2.5	2.5
RPE5C1H181J1A1C03B	C0G	50	180 ±5%	3.5 x 3.0	2.5	2.5
RPE5C1H221J1A1C03B	C0G	50	220 ±5%	3.5 x 3.0	2.5	2.5
RPE5C1H271J1A1C03B	C0G	50	270 ±5%	3.5 x 3.0	2.5	2.5
RPE5C1H331J1A1C03B	C0G	50	330 ±5%	3.5 x 3.0	2.5	2.5
RPE5C1H391J1A1C03B	C0G	50	390 ±5%	3.5 x 3.0	2.5	2.5
RPE5C1H471J1A1C03B	C0G	50	470 ±5%	3.5 x 3.0	2.5	2.5
RPE5C1H561J1A1C03B	C0G	50	560 ±5%	3.5 x 3.0	2.5	2.5
RPE5C1H681J1A1C03B	C0G	50	680 ±5%	3.5 x 3.0	2.5	2.5
RPE5C1H821J1A1C03B	C0G	50	820 ±5%	3.5 x 3.0	2.5	2.5
RPE5C1H102J1A1C03B	C0G	50	1000 ±5%	3.5 x 3.0	2.5	2.5
RPE5C1H122J1A1C03B	C0G	50	1200 ±5%	3.5 x 3.0	2.5	2.5
RPE5C1H152J1A1C03B	C0G	50	1500 ±5%	3.5 x 3.0	2.5	2.5
RPE5C1H182J1A1D03B	C0G	50	1800 ±5%	3.5 x 3.0	2.5	2.5
RPE5C1H222J1A1D03B	C0G	50	2200 ±5%	3.5 x 3.0	2.5	2.5
RPE5C2A1R0C1A1D03B	C0G	100	1.0 ±0.25pF	3.5 x 3.0	2.5	2.5
RPE5C2A2R0C1A1D03B	C0G	100	2.0 ±0.25pF	3.5 x 3.0	2.5	2.5
RPE5C2A3R0C1A1D03B	C0G	100	3.0 ±0.25pF	3.5 x 3.0	2.5	2.5
RPE5C2A4R0C1A1D03B	C0G	100	4.0 ±0.25pF	3.5 x 3.0	2.5	2.5
RPE5C2A5R0C1A1D03B	C0G	100	5.0 ±0.25pF	3.5 x 3.0	2.5	2.5
RPE5C2A6R0D1A1D03B	C0G	100	6.0 ±0.5pF	3.5 x 3.0	2.5	2.5
RPE5C2A7R0D1A1Y03B	C0G	100	7.0 ±0.5pF	3.5 x 3.0	2.5	2.5
RPE5C2A8R0D1A1Y03B	C0G	100	8.0 ±0.5pF	3.5 x 3.0	2.5	2.5
RPE5C2A9R0D1A1Y03B	C0G	100	9.0 ±0.5pF	3.5 x 3.0	2.5	2.5
RPE5C2A100J1A1Y03B	C0G	100	10 ±5%	3.5 x 3.0	2.5	2.5
RPE5C2A120J1A1Y03B	C0G	100	12 ±5%	3.5 x 3.0	2.5	2.5
RPE5C2A150J1A1Y03B	C0G	100	15 ±5%	3.5 x 3.0	2.5	2.5
RPE5C2A180J1A1Y03B	C0G	100	18 ±5%	3.5 x 3.0	2.5	2.5
RPE5C2A220J1A1Y03B	C0G	100	22 ±5%	3.5 x 3.0	2.5	2.5
RPE5C2A270J1A1Y03B	C0G	100	27 ±5%	3.5 x 3.0	2.5	2.5

Continued on the following page. 

△Note • This PDF catalog is downloaded from the website of Murata Manufacturing co., Ltd. Therefore, it's specifications are subject to change or our products in it may be discontinued without advance notice. Please check with our sales representatives or product engineers before ordering.
 • This PDF catalog has only typical specifications because there is no space for detailed specifications. Therefore, please approve our product specifications or transact the approval sheet for product specifications before ordering.

Continued from the preceding page.

Part Number	Temp. Char.	Rated Voltage (Vdc)	Capacitance (pF)	Dimensions LxW (mm)	Dimension T (mm)	Lead Space F (mm)
RPE5C2A330J1A1Y03B	C0G	100	33 ±5%	3.5 x 3.0	2.5	2.5
RPE5C2A390J1A1Y03B	C0G	100	39 ±5%	3.5 x 3.0	2.5	2.5
RPE5C2A470J1A1Y03B	C0G	100	47 ±5%	3.5 x 3.0	2.5	2.5
RPE5C2A560J1A1Y03B	C0G	100	56 ±5%	3.5 x 3.0	2.5	2.5
RPE5C2A680J1A1Y03B	C0G	100	68 ±5%	3.5 x 3.0	2.5	2.5
RPE5C2A820J1A1Y03B	C0G	100	82 ±5%	3.5 x 3.0	2.5	2.5
RPE5C2A101J1A1Y03B	C0G	100	100 ±5%	3.5 x 3.0	2.5	2.5
RPE5C2A121J1A1Y03B	C0G	100	120 ±5%	3.5 x 3.0	2.5	2.5
RPE5C2A151J1A1Y03B	C0G	100	150 ±5%	3.5 x 3.0	2.5	2.5
RPE5C2A181J1A1Y03B	C0G	100	180 ±5%	3.5 x 3.0	2.5	2.5
RPE5C2A221J1A1Y03B	C0G	100	220 ±5%	3.5 x 3.0	2.5	2.5
RPE5C2A271J1A1Y03B	C0G	100	270 ±5%	3.5 x 3.0	2.5	2.5
RPE5C2A331J1A1Y03B	C0G	100	330 ±5%	3.5 x 3.0	2.5	2.5
RPE5C2A391J1A1Y03B	C0G	100	390 ±5%	3.5 x 3.0	2.5	2.5
RPE5C2A471J1A1Y03B	C0G	100	470 ±5%	3.5 x 3.0	2.5	2.5
RPE5C2A561J1A1D03B	C0G	100	560 ±5%	3.5 x 3.0	2.5	2.5
RPE5C2A681J1A1D03B	C0G	100	680 ±5%	3.5 x 3.0	2.5	2.5
RPE5C2A821J1A1D03B	C0G	100	820 ±5%	3.5 x 3.0	2.5	2.5
RPE5C2A102J1A1D03B	C0G	100	1000 ±5%	3.5 x 3.0	2.5	2.5

Small Size, High Dielectric Constant Type, X7R Characteristics

Part Number	Temp. Char.	Rated Voltage (Vdc)	Capacitance	Dimensions LxW (mm)	Dimension T (mm)	Lead Space F (mm)
RPER71H221K1A1C03B	X7R	50	220pF ±10%	3.5 x 3.0	2.5	2.5
RPER71H331K1A1C03B	X7R	50	330pF ±10%	3.5 x 3.0	2.5	2.5
RPER71H471K1A1C03B	X7R	50	470pF ±10%	3.5 x 3.0	2.5	2.5
RPER71H681K1A1C03B	X7R	50	680pF ±10%	3.5 x 3.0	2.5	2.5
RPER71H102K1A1C03B	X7R	50	1000pF ±10%	3.5 x 3.0	2.5	2.5
RPER71H152K1A1C03B	X7R	50	1500pF ±10%	3.5 x 3.0	2.5	2.5
RPER71H222K1A1C03B	X7R	50	2200pF ±10%	3.5 x 3.0	2.5	2.5
RPER71H332K1A1C03B	X7R	50	3300pF ±10%	3.5 x 3.0	2.5	2.5
RPER71H472K1A1C03B	X7R	50	4700pF ±10%	3.5 x 3.0	2.5	2.5
RPER71H682K1A1C03B	X7R	50	6800pF ±10%	3.5 x 3.0	2.5	2.5
RPER71H103K1A1C03B	X7R	50	10000pF ±10%	3.5 x 3.0	2.5	2.5
RPER71H153K1A1C03B	X7R	50	15000pF ±10%	3.5 x 3.0	2.5	2.5
RPER71H223K1A1C03B	X7R	50	22000pF ±10%	3.5 x 3.0	2.5	2.5
RPER71H333K1A1C03B	X7R	50	33000pF ±10%	3.5 x 3.0	2.5	2.5
RPER71H473K1A1C03B	X7R	50	47000pF ±10%	3.5 x 3.0	2.5	2.5
RPER71H683K1A1C03B	X7R	50	68000pF ±10%	3.5 x 3.0	2.5	2.5
RPER71H104K1A1C03B	X7R	50	0.10μF ±10%	3.5 x 3.0	2.5	2.5
RPER72A221K1A1D03B	X7R	100	220pF ±10%	3.5 x 3.0	2.5	2.5
RPER72A331K1A1D03B	X7R	100	330pF ±10%	3.5 x 3.0	2.5	2.5
RPER72A471K1A1D03B	X7R	100	470pF ±10%	3.5 x 3.0	2.5	2.5
RPER72A681K1A1D03B	X7R	100	680pF ±10%	3.5 x 3.0	2.5	2.5
RPER72A102K1A1C03B	X7R	100	1000pF ±10%	3.5 x 3.0	2.5	2.5
RPER72A152K1A1C03B	X7R	100	1500pF ±10%	3.5 x 3.0	2.5	2.5
RPER72A222K1A1C03B	X7R	100	2200pF ±10%	3.5 x 3.0	2.5	2.5
RPER72A332K1A1C03B	X7R	100	3300pF ±10%	3.5 x 3.0	2.5	2.5
RPER72A472K1A1C03B	X7R	100	4700pF ±10%	3.5 x 3.0	2.5	2.5
RPER72A682K1A1C03B	X7R	100	6800pF ±10%	3.5 x 3.0	2.5	2.5
RPER72A103K1A1C03B	X7R	100	10000pF ±10%	3.5 x 3.0	2.5	2.5

Small Size, High Dielectric Constant Type, Z5U Characteristics

Part Number	Temp. Char.	Rated Voltage (Vdc)	Capacitance	Dimensions LxW (mm)	Dimension T (mm)	Lead Space F (mm)
RPEE41H102M1A1C03B	Z5U	50	1000pF ±20%	3.5 x 3.0	2.5	2.5
RPEE41H222M1A1C03B	Z5U	50	2200pF ±20%	3.5 x 3.0	2.5	2.5
RPEE41H472M1A1C03B	Z5U	50	4700pF ±20%	3.5 x 3.0	2.5	2.5
RPEE41H103M1A1C03B	Z5U	50	10000pF ±20%	3.5 x 3.0	2.5	2.5
RPEE41H223M1A1C03B	Z5U	50	22000pF ±20%	3.5 x 3.0	2.5	2.5
RPEE41H473M1A1C03B	Z5U	50	47000pF ±20%	3.5 x 3.0	2.5	2.5
RPEE41H104M1A1C03B	Z5U	50	0.10μF ±20%	3.5 x 3.0	2.5	2.5
RPEE42A102M1A1D03B	Z5U	100	1000pF ±20%	3.5 x 3.0	2.5	2.5
RPEE42A222M1A1D03B	Z5U	100	2200pF ±20%	3.5 x 3.0	2.5	2.5
RPEE42A472M1A1D03B	Z5U	100	4700pF ±20%	3.5 x 3.0	2.5	2.5
RPEE42A103M1A1D03B	Z5U	100	10000pF ±20%	3.5 x 3.0	2.5	2.5

Small Size, High Dielectric Constant Type, Y5V Characteristics

Part Number	Temp. Char.	Rated Voltage (Vdc)	Capacitance	Dimensions LxW (mm)	Dimension T (mm)	Lead Space F (mm)
RPEF51H102Z1A1C03B	Y5V	50	1000pF +80/-20%	3.5 x 3.0	2.5	2.5
RPEF51H222Z1A1C03B	Y5V	50	2200pF +80/-20%	3.5 x 3.0	2.5	2.5
RPEF51H472Z1A1C03B	Y5V	50	4700pF +80/-20%	3.5 x 3.0	2.5	2.5
RPEF51H103Z1A1C03B	Y5V	50	10000pF +80/-20%	3.5 x 3.0	2.5	2.5
RPEF51H223Z1A1C03B	Y5V	50	22000pF +80/-20%	3.5 x 3.0	2.5	2.5
RPEF51H473Z1A1C03B	Y5V	50	47000pF +80/-20%	3.5 x 3.0	2.5	2.5
RPEF51H104Z1A1C03B	Y5V	50	0.10μF +80/-20%	3.5 x 3.0	2.5	2.5
RPEF51H224Z1A1C03B	Y5V	50	0.22μF +80/-20%	3.5 x 3.0	2.5	2.5
RPEF52A102Z1A1D03B	Y5V	100	1000pF +80/-20%	3.5 x 3.0	2.5	2.5
RPEF52A222Z1A1D03B	Y5V	100	2200pF +80/-20%	3.5 x 3.0	2.5	2.5
RPEF52A472Z1A1D03B	Y5V	100	4700pF +80/-20%	3.5 x 3.0	2.5	2.5
RPEF52A103Z1A1D03B	Y5V	100	10000pF +80/-20%	3.5 x 3.0	2.5	2.5

Specifications and Test Methods

No.	Item	Specifications		Test Method												
		Temperature Compensating Type	High Dielectric Constant Type													
1	Operating Temperature Range	-55 to +125°C	Char. X7R : -55 to +125°C Char. Z5U : +10 to + 85°C Char. Y5V : -30 to + 85°C													
2	Rated Voltage	See previous pages		The rated voltage is defined as the maximum voltage which may be applied continuously to the capacitor. When AC voltage is superimposed on DC voltage, V^{P-P} or V^{0-P} , whichever is larger, should be maintained within the rated voltage range.												
3	Appearance	No defects or abnormalities		Visual inspection												
4	Dimension and Marking	See previous pages		Visual inspection, Vernier Caliper												
5	Dielectric Strength	Between Terminals	No defects or abnormalities	The capacitors should not be damaged when DC voltages of *300% of the rated voltage are applied between the terminals for 1 to 5 sec. (Charge/Discharge current \leq 50mA) * 250% for char. X7R, Z5U, Y5V The capacitor is placed in a container with metal balls of 1mm diameter so that each terminal, short-circuited, is kept approximately 2mm from the balls as shown in the figure, and 250% of the rated DC voltage is impressed for 1 to 5 sec. between capacitor terminals and metal balls. (Charge/Discharge current \leq 50mA)												
		Body Insulation	No defects or abnormalities													
6	Insulation Resistance	Between Terminals	100,000M Ω min. or 1000 Ω • F min. (whichever is smaller) Char. X7R : 100,000M Ω min. or 1000 Ω • F min. (whichever is smaller) Char. Z5U : 10,000M Ω min. or 500 Ω • F min. (whichever is smaller) Char. Y5V : (whichever is smaller)	The insulation resistance should be measured with a DC voltage not exceeding the rated voltage at normal temperature and humidity and within 2 min. of charging. (Charge/Discharge current \leq 50mA)												
7	Capacitance	Within the specified tolerance		The capacitance, Q/D.F. should be measured at 25°C at the frequency and voltage shown in the table.												
8	Q/Dissipation Factor (D.F.)	30pF min. : Q \geq 1000 30pF max. : Q \geq 400+20C C : Nominal capacitance (pF)	Char. X7R } : 0.025 max. Char. Z5U } Char. Y5V : 0.05 max.	<table border="1"> <thead> <tr> <th>Char. Item</th> <th>C0G (1000pF and below)</th> <th>C0G (more than 1000pF) X7R, Y5V</th> <th>Z5U</th> </tr> </thead> <tbody> <tr> <td>Frequency</td> <td>1\pm0.1MHz</td> <td>1\pm0.1kHz</td> <td>1\pm0.1kHz</td> </tr> <tr> <td>Voltage</td> <td>AC0.5 to 5V (r.m.s.)</td> <td>AC1\pm0.2V (r.m.s.)</td> <td>AC0.5\pm0.05V (r.m.s.)</td> </tr> </tbody> </table>	Char. Item	C0G (1000pF and below)	C0G (more than 1000pF) X7R, Y5V	Z5U	Frequency	1 \pm 0.1MHz	1 \pm 0.1kHz	1 \pm 0.1kHz	Voltage	AC0.5 to 5V (r.m.s.)	AC1 \pm 0.2V (r.m.s.)	AC0.5 \pm 0.05V (r.m.s.)
Char. Item	C0G (1000pF and below)	C0G (more than 1000pF) X7R, Y5V	Z5U													
Frequency	1 \pm 0.1MHz	1 \pm 0.1kHz	1 \pm 0.1kHz													
Voltage	AC0.5 to 5V (r.m.s.)	AC1 \pm 0.2V (r.m.s.)	AC0.5 \pm 0.05V (r.m.s.)													
9	Capacitance Temperature Characteristics	Capacitance Change	Within the specified tolerance (Table A)	Within the specified tolerance (Table B)												
		Temperature Coefficient	Within the specified tolerance (Table A)													
		Capacitance Drift	Within \pm 0.2% or \pm 0.05pF (whichever is larger)													

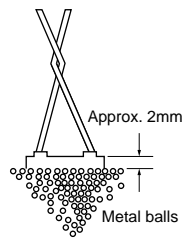

Continued on the following page.

Specifications and Test Methods

Continued from the preceding page.

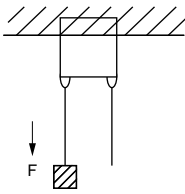
No.	Item	Specifications		Test Method	
		Temperature Compensating Type	High Dielectric Constant Type		
10	Terminal Strength	Tensile Strength	Termination not to be broken or loosened		<p>As in the figure, fix the capacitor body, apply the force gradually to each lead in the radial direction of the capacitor until reaching 10N* and then keep the force applied for 10±1 sec.</p>  <p>* 5N for L3.5 x W3.0 (mm)</p>
		Bending Strength	Termination not to be broken or loosened		
11	Vibration Resistance	Appearance	No defects or abnormalities		<p>The capacitor is soldered securely to a supporting terminal and a 10 to 55Hz vibration of 1.5mm peak-peak amplitude is applied for 6 hrs. total, 2 hrs. in each mutually perpendicular direction. Allow 1 min. to cycle the frequency from 10Hz to 55Hz and the converse.</p>
		Capacitance	Within the specified tolerance		
		Q/D.F.	30pF min. : $Q \geq 1000$ 30pF max. : $Q \geq 400+20C$ C : Nominal capacitance (pF)	Char. X7R } : 0.025 max. Char. Z5U } Char. Y5V } : 0.05 max.	
12	Solderability of Leads	Solder is deposited on unintermittently immersed portion in axial direction covering 3/4 or more in circumferential direction of lead wires.		<p>The terminal of a capacitor is dipped into a 25% ethanol (JIS-K-8101) solution of rosin (JIS-K-5902) and then into molten solder (JIS-H-4341, H63A) of 235±5°C for 2±0.5 sec. In both cases the depth of dipping is up to about 1.5mm to 2mm from the terminal body.</p>	
13	Resistance to Soldering Heat	Appearance	No defects or abnormalities		<p>The lead wire is immersed in the melted solder (JIS-H-4341, H63A) 1.5mm to 2mm from the main body at 270±5°C for 3±0.5 sec. (L3.5 x W3.0 (mm) type) or 350±10°C for 3.5±0.5 sec. (all other types). The specified items are measured after 24±2 hrs. (temperature compensating type) or 48±4 hrs. (high dielectric type).</p> <p>• Initial measurement for high dielectric constant type</p> <p>The capacitors are heat treated for 1 hr. at 150±10 °C, allowed to set at room temperature for 48±4 hrs., and given an initial measurement.</p>
		Capacitance Change	Within ±2.5% or ±0.25pF (whichever is larger)	Char. X7R : Within ±7.5% Char. Z5U } : Within ±20% Char. Y5V }	
		Dielectric Strength (Between Terminals)	No defects		
14	Temperature and Immersion Cycle	Appearance	No defects or abnormalities		<p>First, repeat the following temperature/time cycle 5 times :</p> <p>lowest operating temperature ±3°C/30±3 min. >> ordinary temperature/3 min. max. >> highest operating temperature ±3°C/30±3 min. >> ordinary temperature/3 min. max.</p> <p>Next, repeat twice the successive cycles of immersion, each cycle consisting of immersion in a fresh water at 65±5°C for 15 min. and immersion in a saturated aqueous solution of salt at 0±3°C for 15 min.</p> <p>The capacitor is then promptly washed in running water, dried with a drying cloth, and allowed to sit at room temperature for 24±2 hrs. (temperature compensating type) or 48±4 hrs. (high dielectric type).</p> <p>• Initial measurement for high dielectric constant type</p> <p>The capacitors are heat treated for 1 hr. at 150±10 °C, allowed to sit at room temperature for 48 ±4 hrs., and given an initial measurement.</p>
		Capacitance Change	Within ±5% or ±0.5pF (whichever is larger)	Char. X7R : Within ±12.5% Char. Z5U } : Within ±30% Char. Y5V }	
		Q/D.F.	30pF min. : $Q \geq 350$ 10pF to 30pF : $Q \geq 275 + \frac{5}{C}$ 10pF max. : $Q \geq 200+10C$ C : Nominal capacitance (pF)	Char. X7R : 0.05 max. Char. Z5U } : 0.075 max. Char. Y5V }	
		Insulation Resistance	10000MΩ or 500Ω • F min. (whichever is smaller)	Char. X7R : 10000MΩ or 500Ω • F min. (whichever is smaller) Char. Z5U } : 1000MΩ or 50Ω • F min. Char. Y5V } : (whichever is smaller)	
		Dielectric Strength (Between Terminals)	No defects or abnormalities		

Continued on the following page. ↗

Specifications and Test Methods

Continued from the preceding page.

No.	Item	Specifications		Test Method	
		Temperature Compensating Type	High Dielectric Constant Type		
15	Humidity (Steady State)	Appearance	No defects or abnormalities		Set the capacitor for 500 ±24 hrs. at 40±2°C in 90 to 95% humidity. Remove and set for 24±2 hrs. (temperature compensating type) and 48±4 hrs. (high dielectric constant type) at room temperature, then measure. • Initial measurement for high dielectric constant type The capacitors are heat treated for 1 hr. at 150±10 °C, allowed to sit at room temperature for 48±4 hrs. and given an initial measurement.
		Capacitance Change	Within ±5% or ±0.5pF (whichever is larger)	Char. X7R : Within ±12.5% Char. Z5U } : Within ±30% Char. Y5V }	
		Q/D.F.	30pF min. : Q ≥ 350 10pF to 30pF : Q ≥ 275+ $\frac{5}{C}$ 10pF max. : Q ≥ 200+10C C : Nominal capacitance (pF)	Char. X7R : 0.05 max. Char. Z5U } : 0.075 max. Char. Y5V }	
		Insulation Resistance	10000MΩ or 500Ω • F min. (whichever is smaller)	Char. X7R : 10000MΩ or 500Ω • F min. (whichever is smaller) Char. Z5U } : 1000MΩ or 50Ω • F min. Char. Y5V } (whichever is smaller)	
16	Humidity Load	Appearance	No defects or abnormalities		Apply the rated voltage for 500 ±24 hrs. at 40±2°C and in 90 to 95% humidity. Remove and set for 24±2 hrs. (temperature compensating type) and 48±4 hrs. (high dielectric constant type) at room temperature, then measure. (Charge/Discharge current ≤ 50mA)
		Capacitance Change	Within ±5% or ±0.5pF (whichever is larger)	Char. X7R : Within ±12.5% Char. Z5U } : Within ±30% Char. Y5V }	
		Q/D.F.	30pF min. : Q ≥ 350 10pF to 30pF : Q ≥ 275+ $\frac{5}{C}$ 10pF max. : Q ≥ 200+10C C : Nominal capacitance (pF)	Char. X7R : 0.05 max. Char. Z5U } : 0.075 max. Char. Y5V }	
		Insulation Resistance	10000MΩ or 500Ω • F min. (whichever is smaller)	Char. X7R : 10000MΩ or 500Ω • F min. (whichever is smaller) Char. Z5U } : 1000MΩ or 50Ω • F min. Char. Y5V } (whichever is smaller)	
17	High Temperature Load	Appearance	No defects or abnormalities		Apply 200% of the rated voltage for 1000 ±48 hrs. at the maximum operating temperature. Remove and set for 24±2 hrs. (temperature compensating type) and 48 ±4 hrs. (high dielectric constant type) at room temperature, then measure. (Charge/Discharge current ≤ 50mA) • Initial measurement for high dielectric constant type A voltage treatment should be given to the capacitor in which a DC voltage of 200% of the rated voltage is applied for 1 hr. at the maximum operating temperature ±3 °C. Then set for 48±4 hrs. at room temperature and conduct initial measurement.
		Capacitance Change	Within ±3% or ±0.3pF (whichever is larger)	Char. X7R : Within ±12.5% Char. Z5U } : Within ±30% Char. Y5V }	
		Q/D.F.	30pF min. : Q ≥ 350 10pF to 30pF : Q ≥ 275+ $\frac{5}{C}$ 10pF max. : Q ≥ 200+10C C : Nominal capacitance (pF)	Char. X7R : 0.04 max. Char. Z5U } : 0.075 max. Char. Y5V }	
		Insulation Resistance	10000MΩ or 500Ω • F min. (whichever is smaller)	Char. X7R : 10000MΩ or 500Ω • F min. (whichever is smaller) Char. Z5U } : 1000MΩ or 50Ω • F min. Char. Y5V } (whichever is smaller)	
18	Solvent Resistance	Appearance	No defects or abnormalities		The capacitor should be fully immersed, unagitated, in reagent at 20 to 25 °C for 30±5 sec. and then remove gently. Marking on the surface of the capacitor should immediately be visually examined. Reagent : • Isopropyl alcohol
		Marking	Legible		

Table A

Char.	Nominal Values (ppm/°C) *1	Capacitance Change from 25°C (%)					
		-55°C		-30°C		-10°C	
		Max.	Min.	Max.	Min.	Max.	Min.
COG	0±30	0.58	-0.24	0.40	-0.17	0.25	-0.11

*1: Nominal values denote the temperature coefficient within a range of 25 to 125°C

Table B

Char.	Temp. Range	Reference Temp.	Cap. Change Rate
X7R	-55 to +125°C	25°C	Within ± 15%
Z5U	+10 to + 85°C		Within $\frac{+22}{-56}$ %
Y5V	-30 to + 85°C		Within $\frac{+22}{-82}$ %

Characteristics Data (Typical Example)

■ Capacitance-Temperature Characteristics

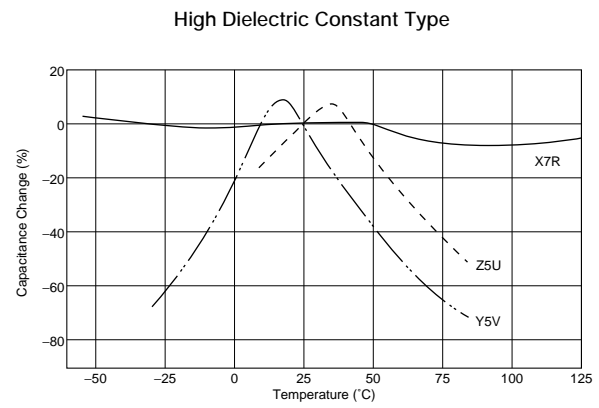
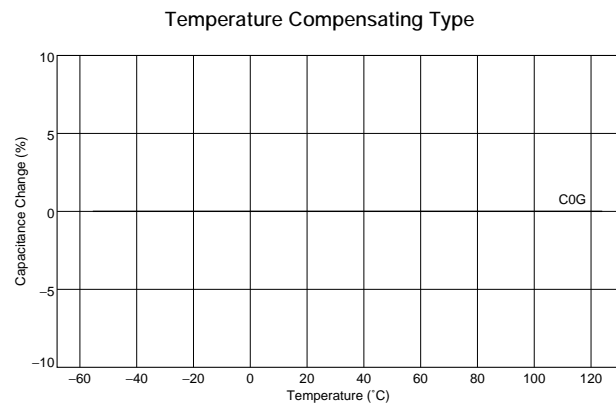

■ Capacitance-DC Voltage Characteristics

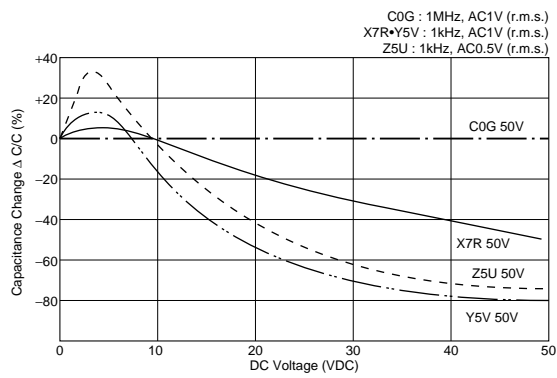

■ Capacitance Change-Aging

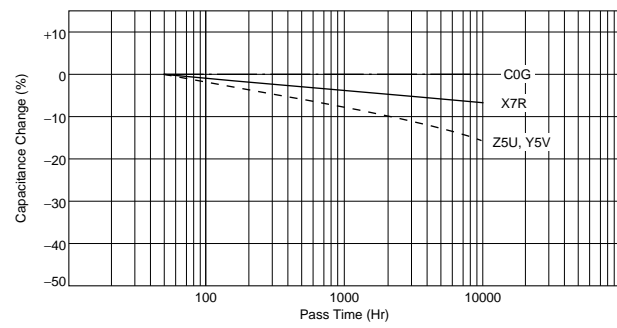

■ Capacitance-Resonant Frequency

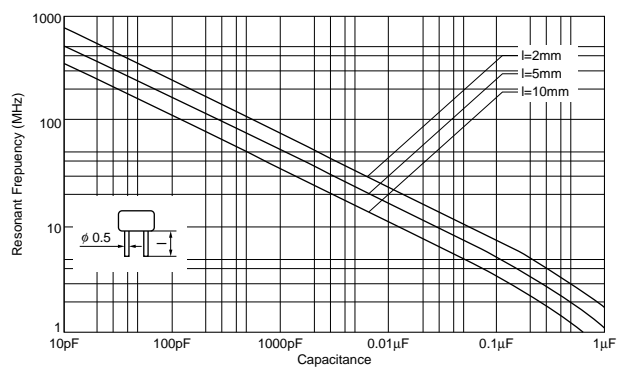

■ Impedance-Frequency Characteristics

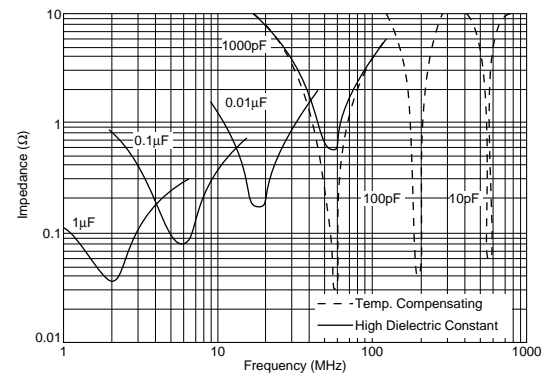

Packaging

■ Packaging

Two types of packaging for epoxy coated monolithic ceramic capacitors are available.

1. Bulk Packaging

Minimum quantity*1

Dimensions code	Dimensions (LxW)	Minimum quantity (pcs./bag)
1	3.5x3.0mm	500
2	5.0x3.5mm	
3	5.0x4.5mm	
4	7.5x5.0mm	
5	7.5x7.5mm	
6	10.0x10.0mm	
8	7.5x5.5mm	100
7	12.5x12.5mm	

Please order with an integral multiple of the minimum quantity above.

2. Tape Carrier Packaging

(1) Dimensions of Ammo Pack

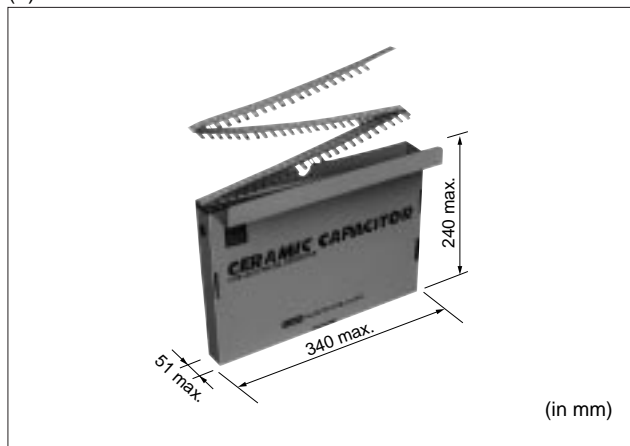

(2) Minimum quantity*1

Dimensions code	Dimensions (LxW)	Minimum quantity (pcs./Ammo Pack)
2	5.0x3.5mm	2000
3	5.0x4.5mm	
4	7.5x5.0mm	
5	7.5x7.5mm	2000*2
8	7.5x5.5mm	1500
6	10.0x10.0mm	

Please order with an integral multiple of the minimum quantity above.

*2 1500 pcs. for **RPER71H335K5□□C03A**, **RPER71H475K5□□C03A**,
RPER72A334K5□□C03A, **RPER72A105K5□□C03A**
 (Two blank columns are filled with the lead style code.)

*1 "Minimum Quantity" means the numbers of units of each delivery or order. The quantity should be an integral multiple of the "minimum quantity". (Please note that the actual delivery quantity in a package may change sometimes.)

Continued on the following page.

Packaging

☐ Continued from the preceding page.

(5) Taping dimensions

Inside Crimp Taping

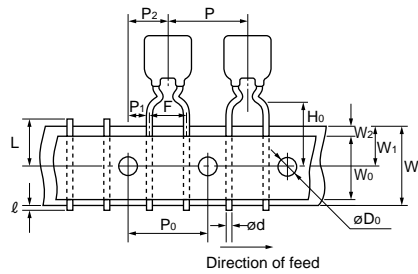

Dimensions and Lead style code	Dimensions (LxW)
2M1	5.0x3.5mm
2M2	
3M1	5.0x4.5mm
3M2	
4M1	7.5x5.0mm
4M2	
8M1	7.5x5.5mm
8M2	

Straight Taping

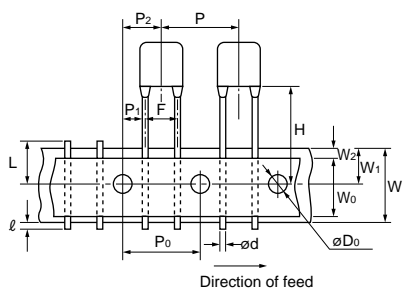

Dimensions and Lead style code	Dimensions (LxW)
5E1	7.5x7.5mm
5E2	
6E1	10.0x10.0mm
6E2	

Outside Crimp Taping

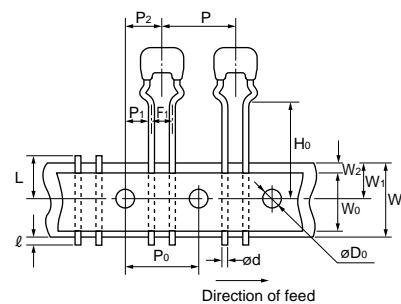

Dimensions and Lead style code	Dimensions (LxW)
2S1	5.0x3.5mm
2S2	
3S1	5.0x4.5mm
3S2	

Item	Code	Dimensions (mm)
Pitch of Component	P	12.7
Pitch of Sprocket Hole	P ₀	12.7±0.2
Lead Spacing	F ₁	2.5 ^{+0.4} _{-0.2}
	F	5.0 ^{+0.6} _{-0.2}
Length from Hole Center to Component Center	P ₂	6.35±1.3
	P ₁	3.85±0.7 5.1±0.7 (S1) (S2)
Length from Hole Center to Lead		254±1.5 Total length of components pitch X 20
Body Dimension		See the individual product specification
Deviation Along Tape, Left or Right Defect	ΔS	±2.0
Carrier Tape Width	W	18.0±0.5
Position of Sprocket Hole	W ₁	9.0 ⁺⁰ _{-0.5}
Lead Distance between Reference and Bottom Plane	H ₀	16.0±0.5 (M1) (S1) 20.0±0.5 (M2) (S2)
	H	20±0.5 (E2), 17.5±0.5 (E1)
For Straight Lead Type	H	20±0.5 (E2), 17.5±0.5 (E1)
Diameter of Sprocket Hole	D ₀	4.0±0.1
Lead Diameter	d	0.5±0.05
Total Tape Thickness	t ₁	0.6±0.3
Total Thickness of Tape and Lead Wire	t ₂	1.5 max.
Body Thickness	T	See the individual product specification
Deviation Across Tape	Δh ₁	1.0 max.
	Δh ₂	1.0 max.
Portion to Cut in Case of Defect	L	11.0 ⁺⁰ _{-1.0}
Protrusion Length	ℓ	0.5 max.
Hold Down Tape Width	W ₀	9.5 min.
Hold Down Tape Position	W ₂	1.5±1.5
Coating Extension		See the individual product specification

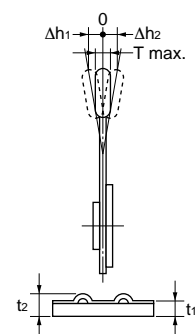
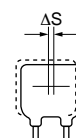

 **Caution**

■  **Caution (Storage and Operating Condition)**

Operating and storage environment

The insulating coating of capacitors does not form a perfect seal; therefore, do not use or store capacitors in a corrosive atmosphere, especially where chloride gas, sulfide gas, acid, alkali, salt or the like are present. And avoid exposure to moisture. Before cleaning, bonding or molding this product, verify that these processes do not affect product quality by testing the performance of a cleaned, bonded or molded product in the intended

equipment. Store the capacitors where the temperature and relative humidity do not exceed 5 to 40 degrees centigrade and 20 to 70%.
Use capacitors within 6 months.

FAILURE TO FOLLOW THE ABOVE CAUTIONS MAY RESULT, WORST CASE, IN A SHORT CIRCUIT AND CAUSE FUMING OR PARTIAL DISPERSION WHEN THE PRODUCT IS USED.

⚠Caution

■ ⚠Caution (Rating)

1. Operating Voltage

When DC-rated capacitors are to be used in AC or ripple current circuits, be sure to maintain the V_{p-p} value of the applied voltage or the V_{0-p} which contains DC bias within the rated voltage range.

When the voltage is applied to the circuit, starting or stopping may generate irregular voltage for a transit period because of resonance or switching. Be sure to use a capacitor with a rated voltage range that includes these irregular voltages.

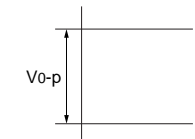
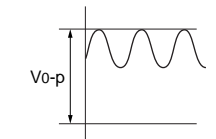
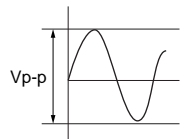
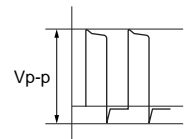
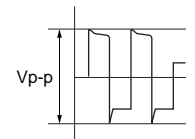
Voltage	DC Voltage	DC+AC Voltage	AC Voltage	Pulse Voltage (1)	Pulse Voltage (2)
Positional Measurement					

2. Operating Temperature and Self-generated Heat

Keep the surface temperature of a capacitor below the upper limit of its rated operating temperature range. Be sure to take into account the heat generated by the capacitor itself. When the capacitor is used in a high-frequency current, pulse current or similar current, it may have self-generated heat due to dielectric loss. In case of "High Dielectric Constant Type Capacitors (X7R/Y5V/Z5U char.)", applied voltage load should be such that self-generated heat is within 20 °C under the condition where the capacitor is subjected at an atmosphere temperature of 25 °C. Please contact us if self-generated heat is occurred with "Temperature Compensating Type Capacitors (C0G char.)". When measuring, use a thermocouple of small thermal capacity-K of $\phi 0.1\text{mm}$ under conditions where the capacitor is not affected by radiant heat from other components or wind from surroundings. Excessive heat may lead to deterioration of the capacitor's characteristics and reliability. (Never attempt to perform measurement with the cooling fan running. Otherwise, accurate measurement cannot be ensured.)

3. Fail-Safe

Be sure to provide an appropriate fail-safe function on your product to prevent a second damage that may be caused by the abnormal function or the failure of our product.

FAILURE TO FOLLOW THE ABOVE CAUTIONS MAY RESULT, WORST CASE, IN A SHORT CIRCUIT AND CAUSE FUMING OR PARTIAL DISPERSION WHEN THE PRODUCT IS USED.

⚠Caution

■ **⚠Caution (Soldering and Mounting)**

1. Vibration and impact

Do not expose a capacitor or its leads to excessive shock or vibration during use.

2. Soldering

When soldering this product to a PCB/PWB, do not exceed the solder heat resistance specification of the capacitor. Subjecting this product to excessive heating could melt the internal junction solder and may result in thermal shocks that can crack the ceramic element.

3. Bonding and resin molding

Before bonding or molding this product, verify that these processes do not affect the quality of capacitor by testing the performance of a bonded or molded product in the intended equipment.
In case of the amount of applications, dryness/

hardening conditions of adhesives and molding resins containing organic solvents (ethyl acetate, methyl ethyl ketone toluene, etc.) are unsuitable, the outer coating resin of a capacitor is damaged by the organic solvents and it may result, worst case, in a short circuit.

The variation in thickness of adhesive or molding resin may cause a outer coating resin cracking and/or ceramic element cracking of a capacitor in a temperature cycling.

FAILURE TO FOLLOW THE ABOVE CAUTIONS MAY RESULT, WORST CASE, IN A SHORT CIRCUIT AND CAUSE FUMING OR PARTIAL DISPERSION WHEN THE PRODUCT IS USED.

■ **⚠Caution (Handling)**

Vibration and impact

Do not expose a capacitor or its leads to excessive shock or vibration during use.

FAILURE TO FOLLOW THE ABOVE CAUTIONS MAY RESULT, WORST CASE, IN A SHORT CIRCUIT AND CAUSE FUMING OR PARTIAL DISPERSION WHEN THE PRODUCT IS USED.

Notice/QS9000 Certificaion

■ Notice (Rating)

Capacitance change of capacitor

1. In case of COG char.

Capacitance might change a little depending on the surrounding temperature or an applied voltage.

Please contact us if you intend to use this product in a strict time constant circuit.

2. In case of X7R/Y5V/Z5U char.

Capacitors have an aging characteristic, whereby the capacitor continually decreases its capacitance slightly if the capacitor is left on for a long time. Moreover, capacitance might change greatly depending on the surrounding temperature or an applied voltage.

So, it is not likely to be suitable for use in a time constant circuit. Please contact us if you need detailed information.

■ Notice (Soldering and Mounting)

1. Cleaning (ultrasonic cleaning)

To perform ultrasonic cleaning, observe the following conditions.

Rinse bath capacity : Output of 20 watts per liter or less.

Rinsing time : 5 min. maximum.

Do not vibrate the PCB/PWB directly.

Excessive ultrasonic cleaning may lead to fatigue destruction of the lead wires.

2. Soldering and Mounting

(1) Allowable Conditions for Soldering Temperature and Time

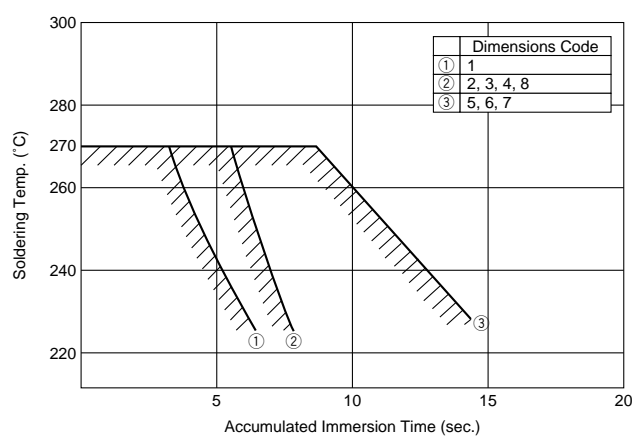

Perform soldering within tolerance range (shaded portion).

(2) Insertion of the Lead Wire

- When soldering, insert the lead wire into the PCB without mechanically stressing the lead wire.
- Insert the lead wire into the PCB with a distance appropriate to the lead space.

■ QS9000 Certifications

Manufacturing plants which produce the products in this catalog have obtained the QS9000 quality system certificate.

Plant
Iwami Murata Manufacturing Co., Ltd.

⚠Note:

1. Export Control
(For customers outside Japan)
Murata products should not be used or sold for use in the development, production, stockpiling or utilization of any conventional weapons or mass-destructive weapons (nuclear weapons, chemical or biological weapons, or missiles), or any other weapons.
(For customers in Japan)
For products which are controlled items subject to the "Foreign Exchange and Foreign Trade Law" of Japan, the export license specified by the law is required for export.
2. Please contact our sales representatives or product engineers before using the products in this catalog for the applications listed below, which require especially high reliability for the prevention of defects which might directly damage to a third party's life, body or property, or when one of our products is intended for use in applications other than those specified in this catalog.
 - ① Aircraft equipment
 - ② Aerospace equipment
 - ③ Undersea equipment
 - ④ Power plant equipment
 - ⑤ Medical equipment
 - ⑥ Transportation equipment (vehicles, trains, ships, etc.)
 - ⑦ Traffic signal equipment
 - ⑧ Disaster prevention / crime prevention equipment
 - ⑨ Data-processing equipment
 - ⑩ Application of similar complexity and/or reliability requirements to the applications listed in the above
3. Product specifications in this catalog are as of January 2006. They are subject to change or our products in it may be discontinued without advance notice. Please check with our sales representatives or product engineers before ordering. If there are any questions, please contact our sales representatives or product engineers.
4. Please read rating and ⚠CAUTION (for storage, operating, rating, soldering, mounting and handling) in this catalog to prevent smoking and/or burning, etc.
5. This catalog has only typical specifications because there is no space for detailed specifications. Therefore, please approve our product specifications or transact the approval sheet for product specifications before ordering.
6. Please note that unless otherwise specified, we shall assume no responsibility whatsoever for any conflict or dispute that may occur in connection with the effect of our and/or a third party's intellectual property rights and other related rights in consideration of your use of our products and/or information described or contained in our catalogs. In this connection, no representation shall be made to the effect that any third parties are authorized to use the rights mentioned above under licenses without our consent.
7. No ozone depleting substances (ODS) under the Montreal Protocol are used in our manufacturing process.

muRata Murata Manufacturing Co., Ltd.

<http://www.murata.com/>

Head Office
1-10-1, Higashi Kotari, Nagaokakyo-shi, Kyoto 617-8555, Japan
Phone: 81-75-951-9111

International Division
3-29-12, Shibuya, Shibuya-ku, Tokyo 150-0002, Japan
Phone: 81-3-5469-6123 Fax: 81-3-5469-6155 E-mail: intl@murata.co.jp

X-ON Electronics

Largest Supplier of Electrical and Electronic Components

Click to view similar products for [Multilayer Ceramic Capacitors MLCC - Leaded](#) category:

Click to view products by [Murata](#) manufacturer:

Other Similar products are found below :

[010-007220-002REV A](#) [M39014/01-1210V](#) [M39014/01-1281V](#) [M39014/01-1335V](#) [M39014/01-1571V](#) [M39014/01-1578V](#) [M39014/01-1593](#)
[M39014/02-1265V](#) [M39014/02-1347](#) [M39014/02-1350](#) [M39014/02-1356VTR1](#) [M39014/22-0167](#) [M39014/22-0734](#) [87043-49](#) [Q52-DK](#)
[AR215F103K4RTR2-3323](#) [C0603C309C5GACTU-CUT-TAPE](#) [C410C221K1G5TATR](#) [C420C102J1G5TATR](#) [C430C104M1U5TATR](#)
[SL155C222MAB](#) [FK26X7R2E104KN006](#) [CCR06CG183GRV](#) [CFB1/2C101J](#) [CFB1/2C102J](#) [CN20C102K](#) [M39014/01-1317](#) [M39014/01-](#)
[1572V](#) [M39014/01-1594V](#) [M39014/02-1236](#) [M39014/02-1321V](#) [M39014/02-1345V](#) [M39014/22-0351](#) [M39014/22-0695](#) [M39014/220767](#)
[M39014/220788](#) [M39014/22-1005](#) [MA405E334MAA](#) [MD015A103KAB](#) [SL301E105MAB](#) [CCR05CG242FRV](#) [KTD101B684M32A0B00](#)
[CCR07CG473KR](#) [CCR05CG820JP](#) [TKC-TMC1206-05-1501-J??](#) [TKC-TMC1206-05-1801-J](#) [TKC-TMC1206-05-20R0-F](#) [TKC-](#)
[TMC1206-05-3901-J](#) [TKC-TMC1206-05-44R2-F](#) [TKC-TMC1206-05-4703-J??](#)