

890-012 and 890-013
 Right Angle Mount PCB, Single Row Nano Connector
 Surface Mount Type

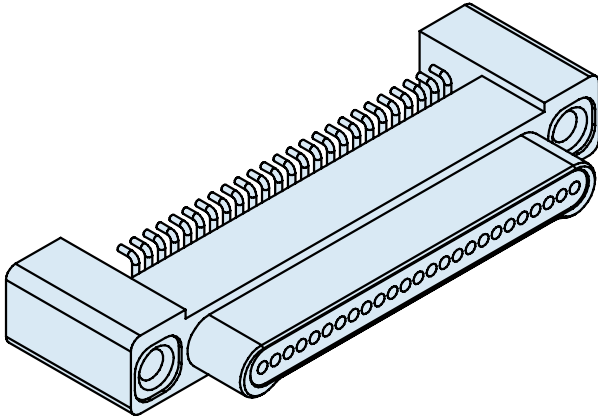

Right Angle SMT PCB Nano Connectors feature gold alloy TwistPin contacts. These nanominiature connectors offer premium performance and reliability for demanding applications. Available with #0-80 female threads.

Pre-Tinned PC Tails are coated with Sn63Pb37 tin-lead for excellent solderability.

Choose Aluminum, Titanium or Stainless Steel Shells in eight layouts from 5 to 51 contacts. Complies to the requirements of MIL-DTL-32139. These connectors are intermateable with any corresponding Glenair Series 890 single row metal shell nanominiature connector.

How to Order Right Angle SMT PCB Connectors

Sample Part Number	890-012	-51P	T	-BRS	T
Series	890-012 Plug, Pin Contacts, Single Row, Right Angle SMT Nanominiature 890-013 Receptacle, Socket Contacts, Single Row, Right Angle SMT Nanominiature				
Insert Arrangement/ Contact Type	Plugs (890-012): 5P, 9P, 15P, 21P, 25P, 31P, 37P, 51P , Receptacles (890-013): 5S, 9S, 15S, 21S, 25S, 31S, 37S, 51S				
Shell Material and Finish	A1 - Aluminum Shell, Cadmium Plating T - Titanium Shell, Unplated A2 - Aluminum Shell, Electroless Nickel Plating S - Stainless Steel Shell, Passivated				
Termination Type	BRS - Board Right Angle Surface Mount				
Hardware	T - Female Thread, #0-80				

Dimensions in inches (millimeters) and are subject to change without notice.

Single Row Nano Right Angle SMT Dimensions

890-012 Plug (Pin) Connectors

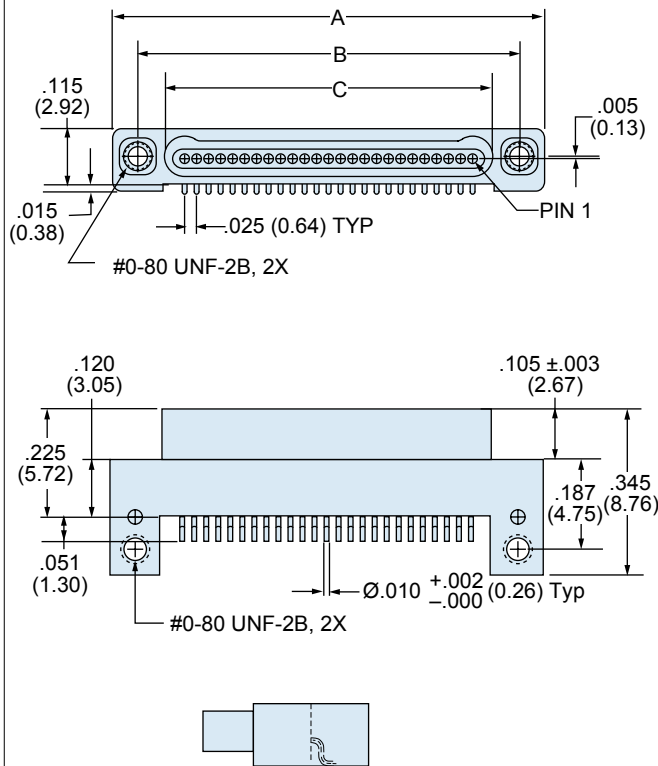

890-013 Receptacle (Socket) Connectors

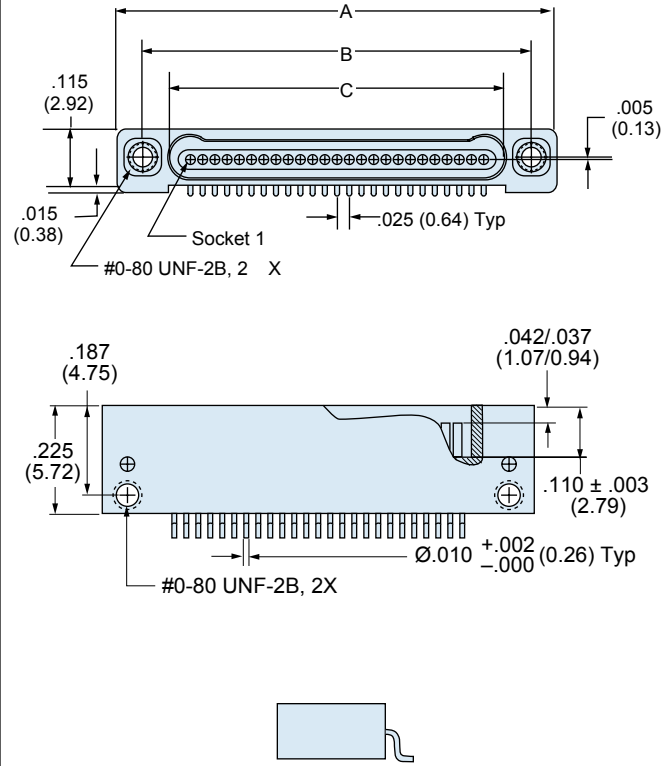

Layout	A		B BSC.		C BSC.	
	In. ± .005	mm. ± 0.13	In.	mm.	In.	mm.
5P	.400	10.16	.295	7.49	.184	4.67
5S	.400	10.16	.295	7.49	.185	4.70
9P	.500	12.70	.395	10.03	.284	7.21
9S	.500	12.70	.395	10.03	.285	7.24
15P	.650	16.51	.545	13.84	.434	11.02
15S	.650	16.51	.545	13.84	.435	11.05
21P	.800	20.32	.695	17.65	.584	14.83
21S	.800	20.32	.695	17.65	.585	14.86
25P	.900	22.86	.795	20.19	.684	17.37
25S	.900	22.86	.795	20.19	.685	17.40
31P	1.050	26.67	.945	24.00	.834	21.18
31S	1.050	26.67	.945	24.00	.835	21.21
37P	1.200	30.48	1.095	27.81	.984	24.99
37S	1.200	30.48	1.095	27.81	.985	24.02
51P	1.550	39.37	1.445	36.70	1.334	33.88
51S	1.550	39.37	1.445	36.70	1.335	33.91

Dimensions in inches (millimeters) and are subject to change without notice.

890-012 and 890-013 Right Angle Mount PCB, Single Row Nano Connector Surface Mount Type



Single Row
Connectors

Right Angle SMT Plug (Pin) Connector Layout 890-012

5 Contacts

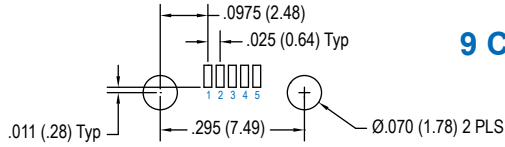

9 Contacts

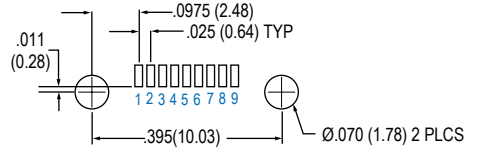

15 Contacts

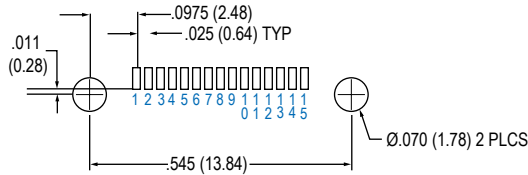

21 Contacts

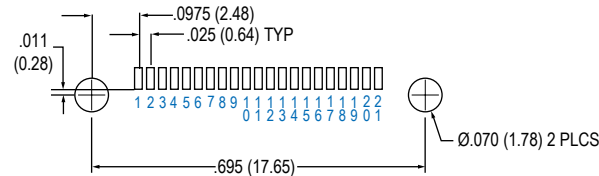

25 Contacts

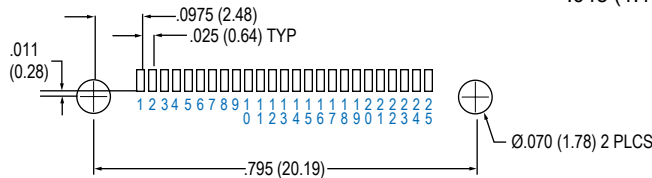

31 Contacts

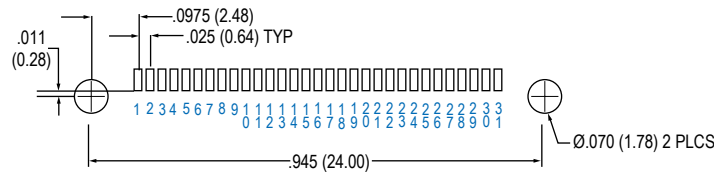

37 Contacts

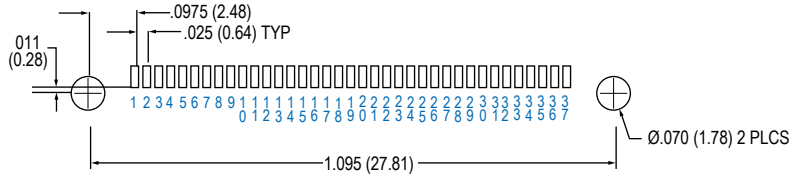

51 Contacts

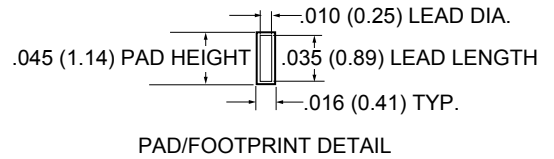
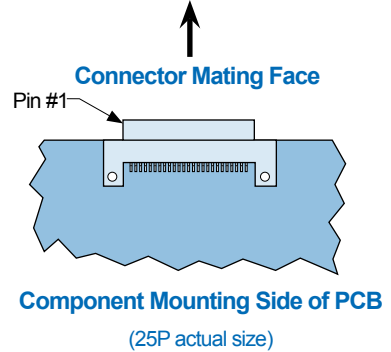
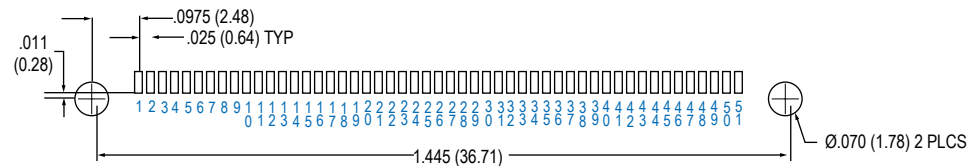

Layouts shown are for connector mounting side of PC Board.





890-012 and 890-013 Right Angle Mount PCB, Single Row Nano Connector Surface Mount Type

Right Angle SMT Receptacle (Socket) Connector Layout 890-013

5 Contacts

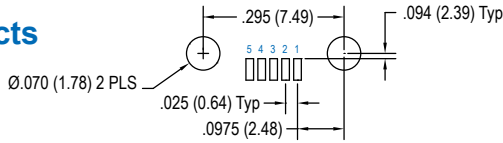

9 Contacts

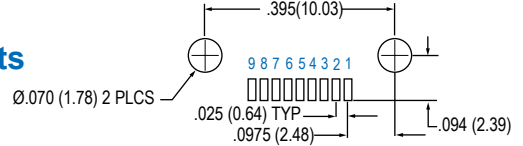

15 Contacts

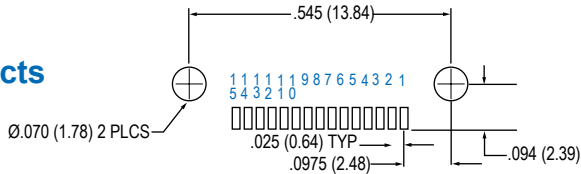

21 Contacts

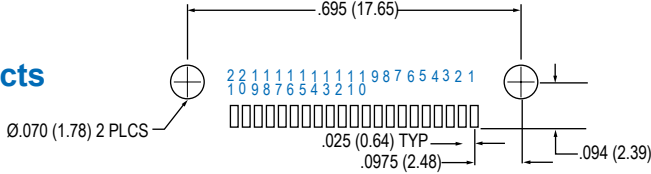

25 Contacts

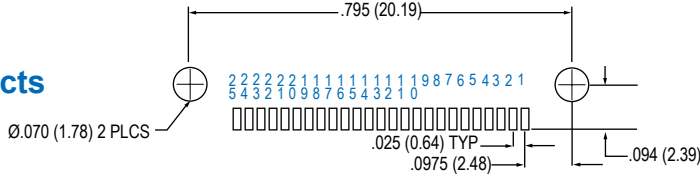

31 Contacts

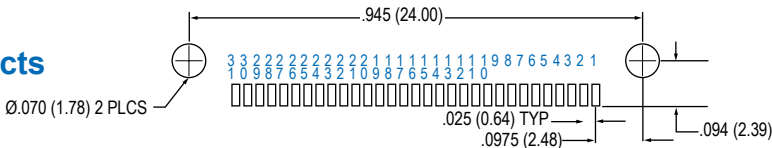

37 Contacts

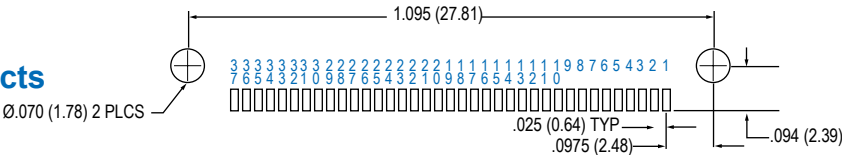

51 Contacts

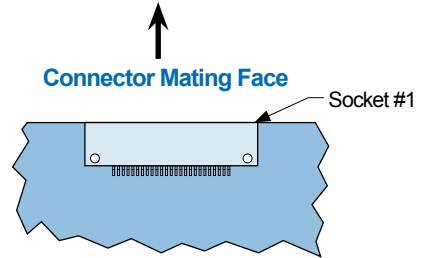
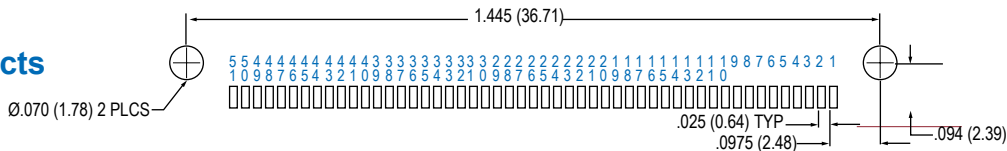

Component Mounting Side of PCB (25S actual size)

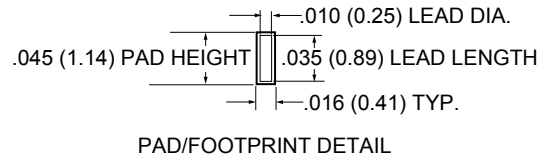

Layouts shown are for connector mounting side of PC Board.

X-ON Electronics

Largest Supplier of Electrical and Electronic Components

Click to view similar products for [D-Sub Standard Connectors](#) category:

Click to view products by [Glenair](#) manufacturer:

Other Similar products are found below :

[DCM37S732N](#) [DAM15P500](#) [DEV09S364GTLF](#) [DEM09P032N](#) [DDM50P732N](#) [DAM15S332N](#) [173109-2218](#) [173109-2466](#) [173109-2436](#)
[173109-2435](#) [56F706-005-LI](#) [56F711-015](#) [015-0341-000](#) [015-0372-008](#) [015-8544-011](#) [017041-0005](#) [020419-0104](#) [012-0515-000](#) [012-9507-](#)
[034](#) [012-9507-114](#) [012-9534-001](#) [020745-0008](#) [609-25P](#) [M24308/2-23Z](#) [M243082310F](#) [M243082410F](#) [M243082411F](#) [M24308/4-21](#)
[CT1A18-11PSA206](#) [CT1N36-5SC](#) [CT2-16S-17PS](#) [CT2-20-15PCAU](#) [CT2-24-12PS](#) [CT2-24-28PSF127A206](#) [CT2-32-9PC](#) [CT6F9767-14-4-](#)
[14S-5PC](#) [CT6FA10SL-4PS](#) [CT7-18-10SC](#) [CT7-18-10SCAU](#) [CT7-18-12SCAU](#) [CT7-18-1PC](#) [CT7-18-1PCAU](#) [CT7-18-21SCAU](#) [M83513/01-](#)
[FC](#) [M83723/76W24619 L/C](#) [M85049/48-3-2F](#) [69001-865](#) [6STD09PCM99B70X](#) [6STD09SCM99B30X](#) [6STD09SCT99S40X](#)