

890-008 and 890-009
Right Angle Mount PCB, Single Row Nano Connector
Thru Hole Type

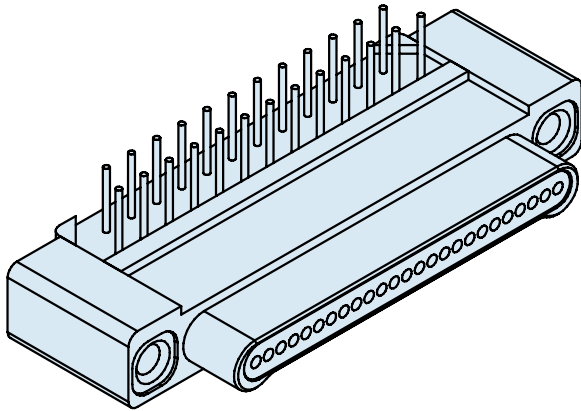

Right Angle Thru Hole PCB Nano Connectors feature gold alloy TwistPin contacts. These nanominiature connectors offer premium performance and reliability for demanding applications. Available with #0-80 female threads, or with jackscrews for use with flexible circuits.

Pre-Tinned PC Tails are coated with Sn63Pb37 tin-lead for excellent solderability.

Choose Aluminum, Titanium or Stainless Steel Shells in eight layouts from 5 to 51 contacts. Complies to the requirements of MIL-DTL-32139. These connectors are interchangeable with any corresponding Glenair Series 890 single row metal shell nanominiature connector.

How To Order Right Angle PCB Connectors						
Sample Part Number	890-008	-51P	A2	-BRT	1	T
Series	890-008 Plug, Pin Contacts, Single Row, Right Angle Thru-Hole PCB Nanominiature 890-009 Receptacle, Socket Contacts, Single Row, Right Angle Thru-Hole PCB Nanominiature					
Insert Arrangement/ Contact Type	Plugs (890-008): 5P, 9P, 15P, 21P, 25P, 31P, 37P, 51P Receptacles (890-009): 5S, 9S, 15S, 21S, 25S, 31S, 37S, 51S					
Shell Material and Finish	A1 - Aluminum Shell, Cadmium Plating T - Titanium Shell, Unplated A2 - Aluminum Shell, Electroless Nickel Plating S - Stainless Steel Shell, Passivated					
Termination Type	BRT - Board Right Angle Thru-Hole					
PC Tail Length	1 - .110 (2.79) 3 - .140 (3.55) 2 - .172 (4.37)					
Hardware	J - Jackscrew, #0-80 T - Female Thread, #0-80					

Dimensions in inches (millimeters) and are subject to change without notice.

890-008 and 890-009 Right Angle Mount PCB, Single Row Nano Connector Thru Hole Type

Single Row Nano Right Angle PCB Dimensions

890-008 Plug (Pin) Connectors

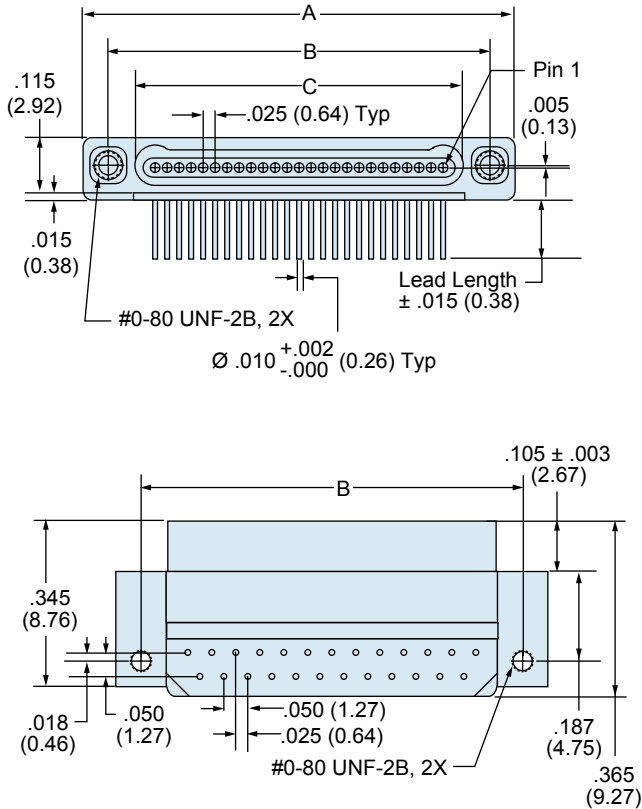

890-009 Receptacle (Socket) Connectors

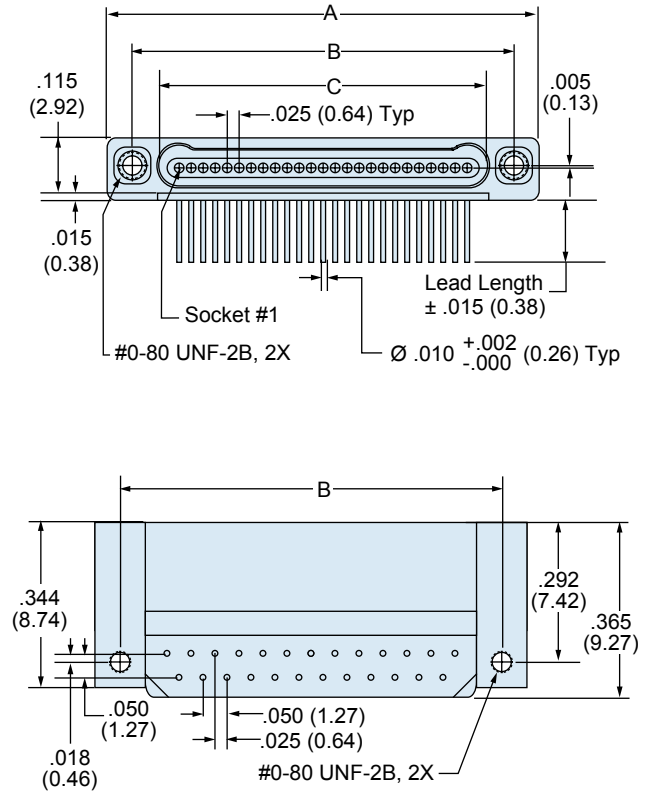

Layout	A		B BSC.		C BSC.	
	In. $\pm .005$	mm. ± 0.13	In.	mm.	In.	mm.
5P	.400	10.16	.295	7.49	.184	4.67
5S	.400	10.16	.295	7.49	.185	4.70
9P	.500	12.70	.395	10.03	.284	7.21
9S	.500	12.70	.395	10.03	.285	7.24
15P	.650	16.51	.545	13.84	.434	11.02
15S	.650	16.51	.545	13.84	.435	11.05
21P	.800	20.32	.695	17.65	.584	14.83
21S	.800	20.32	.695	17.65	.585	14.86
25P	.900	22.86	.795	20.19	.684	17.37
25S	.900	22.86	.795	20.19	.685	17.40
31P	1.050	26.67	.945	24.00	.834	21.18
31S	1.050	26.67	.945	24.00	.835	21.21
37P	1.200	30.48	1.095	27.81	.984	24.99
37S	1.200	30.48	1.095	27.81	.985	24.02
51P	1.550	39.37	1.445	36.70	1.334	33.88
51S	1.550	39.37	1.445	36.70	1.335	33.91

Dimensions in inches (millimeters) and are subject to change without notice.

890-008 and 890-009 Right Angle Mount PCB, Single Row Nano Connector Thru Hole Type



Single Row
Connectors

Right Angle PCB Plug (Pin) Connector Layout 890-008

5 Contacts

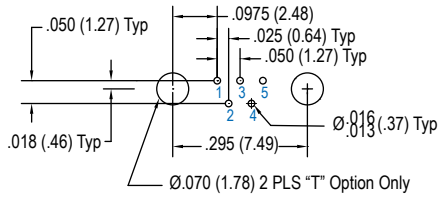

9 Contacts

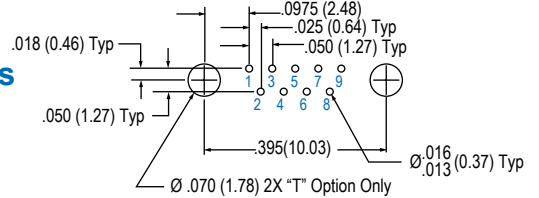

15 Contacts

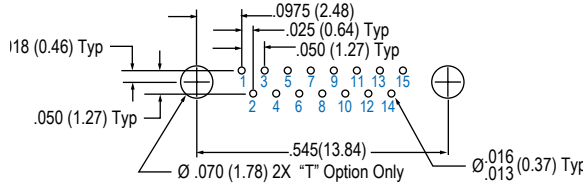

21 Contacts

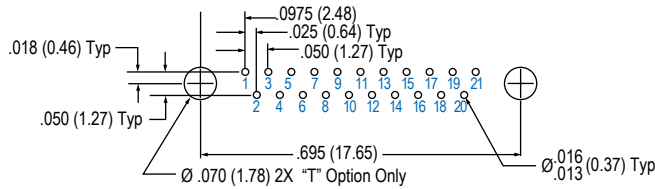

25 Contacts

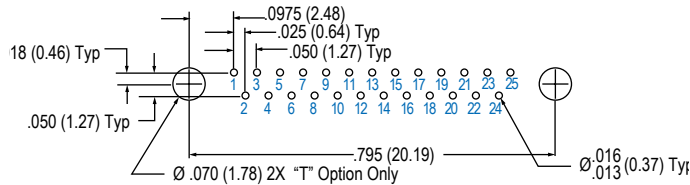

31 Contacts

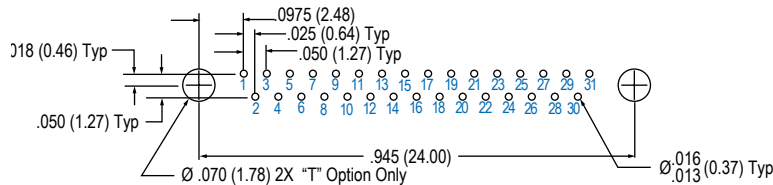

37 Contacts

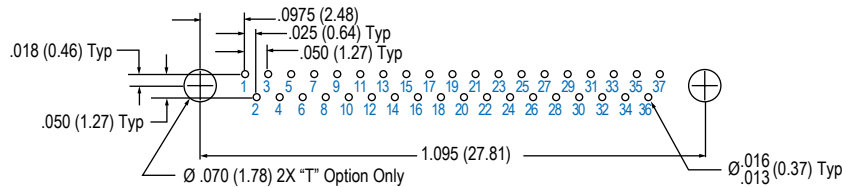

51 Contacts

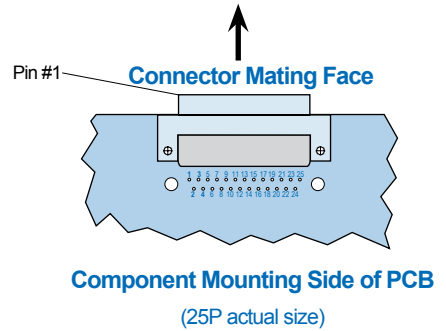
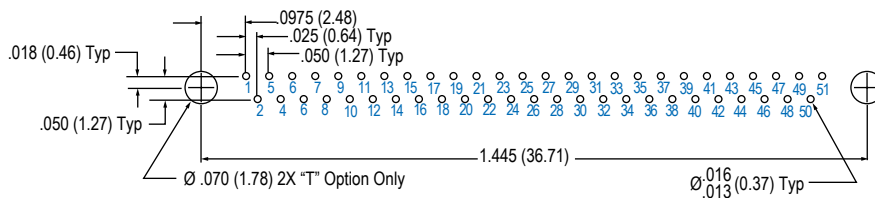

Layouts shown are for connector mounting side of PC Board.



Right Angle PCB Receptacle (Socket) Connector Layout 890-009

5 Contacts

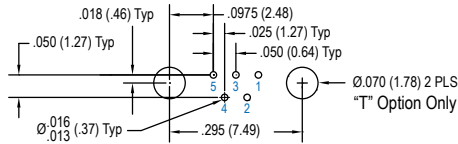

9 Contacts

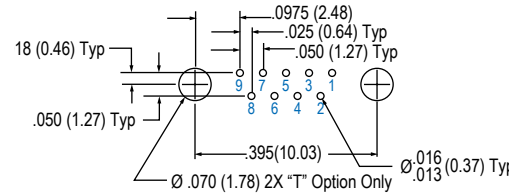

15 Contacts

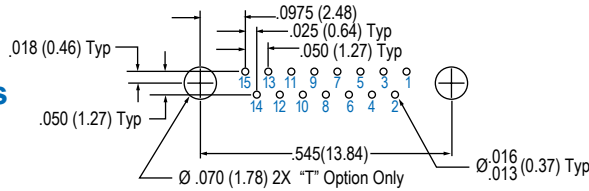

21 Contacts

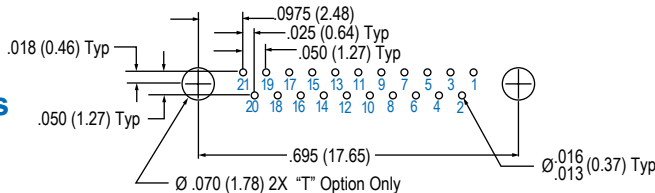

25 Contacts

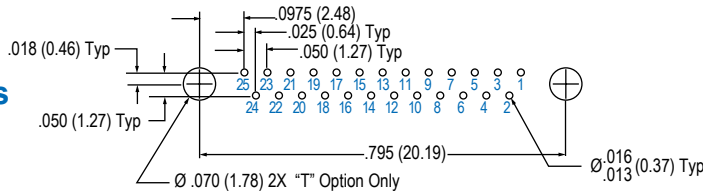

31 Contacts

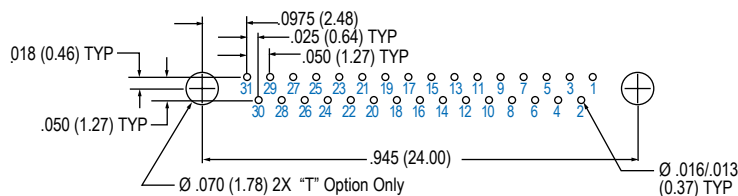

37 Contacts

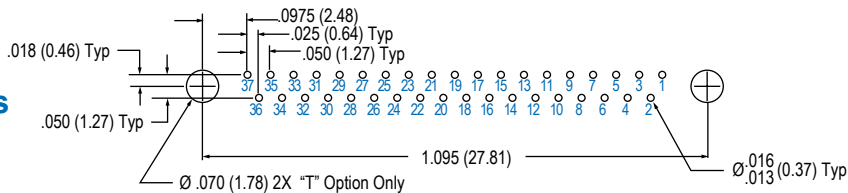

51 Contacts

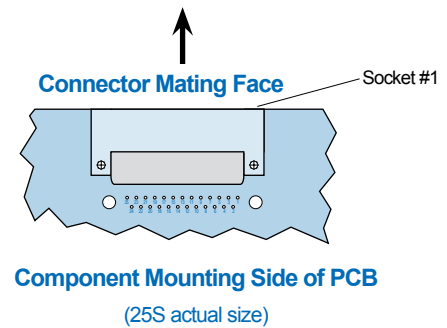
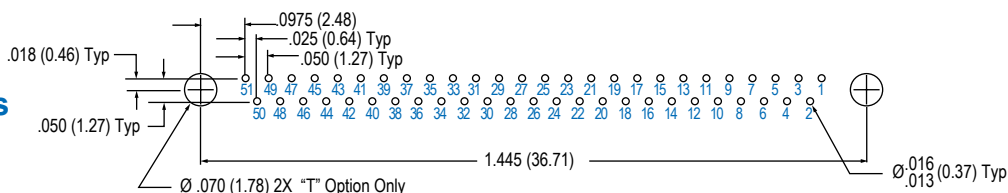

Layouts shown are for connector mounting side of PC Board.

X-ON Electronics

Largest Supplier of Electrical and Electronic Components

Click to view similar products for [Circular DIN Connectors](#) category:

Click to view products by [Glenair](#) manufacturer:

Other Similar products are found below :

[CTV06RQF-25-8SA-LC](#) [CTV06RQF-25-8S-LC](#) [CTV06RQW-25-8SB-LC](#) [CTV06RW-25-20P](#) [CTV06RW-25-20PA](#) [CTV06RW-25-20PB](#)
[CTV06RW-25-20PE-LC](#) [CTV06RW-25-20SB](#) [CTV06RW-25-20SE](#) [CTV07RW-17-8S\(506\)](#) [CTVP00RW-19-32S\(506\)](#) [CTVP00RW-9-35S\(506\)](#) [M83723/71R20416](#) [M83723/71R22196](#) [M83723/71W2039N](#) [M83723/71W24196](#) [M83723/71W2419N](#) [M83723/72A1404N-LC](#)
[M83723/72R1203N](#) [M83723/72W20418](#) [M83723/72W22126](#) [M83723/72W22556](#) [M83723/72W2419N](#) [M83723/72W2461N](#)
[M83723/73R2028N](#) [M83723/73R2039N](#) [M83723/73W1412N](#) [M83723/73W2039N](#) [M83723/74R1624N](#) [M83723/74R1808N](#)
[M83723/74R2212N](#) [M83723/74W1203N](#) [M83723/74W1412N](#) [M83723/74W20416](#) [M83723/74W2041N](#) [M83723/75R10058](#)
[M83723/75W2232N](#) [M83723/76R14157](#) [M83723/76R20256](#) [M83723/76W1808N](#) [M83723/76W2016N](#) [M83723/76W2461N](#)
[M83723/77W2016N](#) [M83723/78R22327](#) [M83723/78W2212N](#) [M83723/78W22556](#) [M85049/50-5F](#) [D38999/20FF11AC](#) [D38999/20FJ20BB](#)
[D38999/20FJ20SC](#)