

finger guards:metal



Description

These finger guards are made from plated steel. The selection chart indicates the suitability of each finger guard for PAPST fans.

Selection Chart

Note: Shaded areas indicate a choice of finger guards for those fans.

Note

Although the guards are designed to meet safety requirements, the equipment manufacturer is responsible for ensuring that their use complies with relevant safety standards.

Fan Size

Fan Series	40 mm	60 mm	80 mm	92 mm	120 mm	127 mm	135 mm	150 mm	171 mm	200 mm
400	LZ29-1									
600		LZ28-1								
2200										LZ21
3300				LZ23						
3400				LZ23-1						
3600				LZ23K						
3800										
3900										
4100					LZ30					
4200					LZ30-4					
4300					LZ30K					
4400					LZ30GB					
4500										
4600										
4800										
5100							LZ25			
5200						LZ35				
5600							LZ25			
5900						LZ35				
6000									LZ26K	
6200									LZ26K	
6400									LZ37	
7000										
7100								LZ24		
7200								LZ27		
7400								LZ27K		
7800										
8300			LZ22N							
8400			LZ32-4							
8500			LZ22K							
8800										
9900					AS 4000					

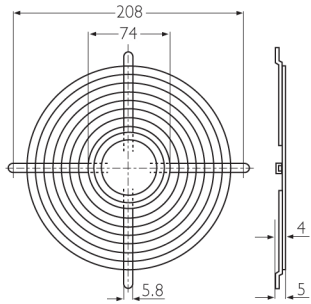

LZ21 Rust resistant steel wire.
2xxx series fans

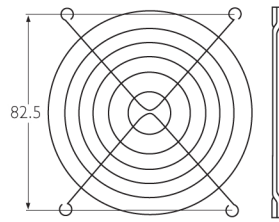

LZ23K Welded steel guard, bright zinc.
3xxx series fans

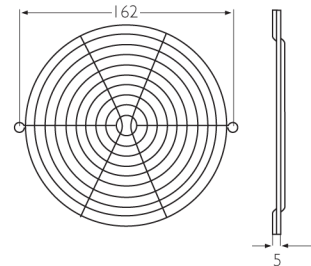

LZ26K Welded steel guard, chromium.
6xxx series fans

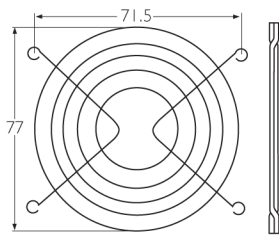

LZ22K Welded steel guard, bright nickel.
8xxx series fans

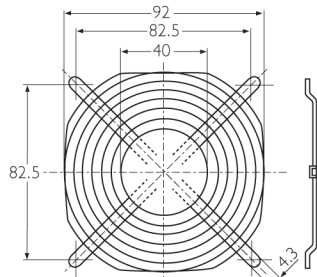

LZ23-I Rust resistant steel wire.
3xxx series fans

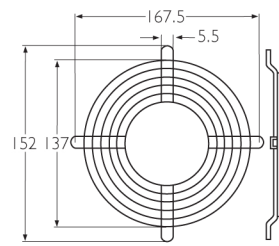

LZ27 Welded steel guard, bright zinc.
7xxx series fans

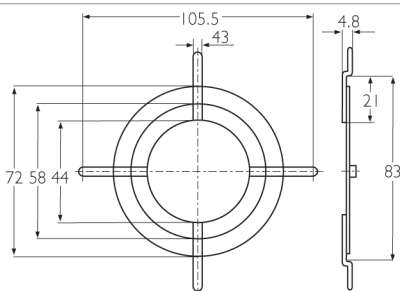

LZ22N Welded steel guard, bright zinc.
8xxx series fans

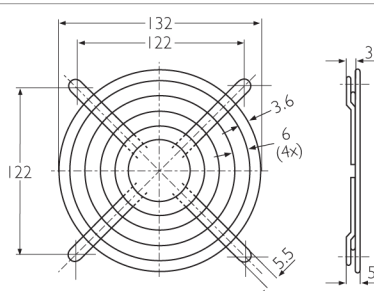

LZ25 Rust resistant steel wire.
5xxx series fans

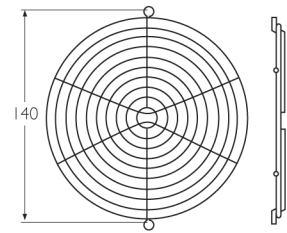

LZ27K Welded steel guard, bright zinc.
7xxx series fans

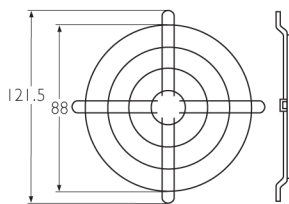

LZ23 Welded steel guard, bright zinc.
3xxx series fans

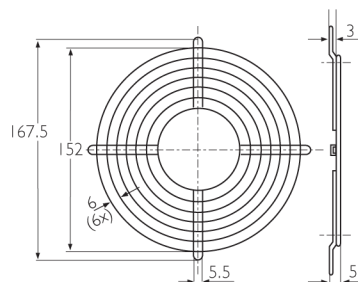

LZ26 Welded steel guard, bright zinc.
6xxx series fans

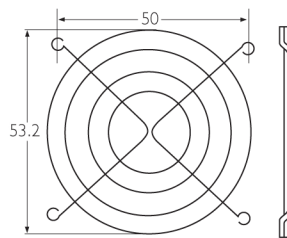

LZ28CP Welded steel guard, chromium.
6xx series fans

finger guards:metal

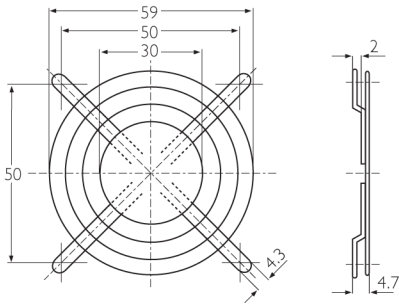

LZ28-1 Rust resistant steel wire.
6xxx series fans

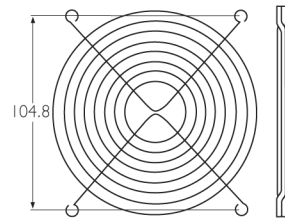

LZ30K Welded steel guard, bright nickel.
4xxx and 9xxx series fans

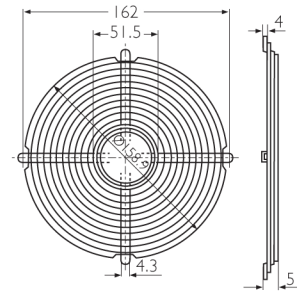

LZ37 Rust resistant steel wire.
6xxx series fans

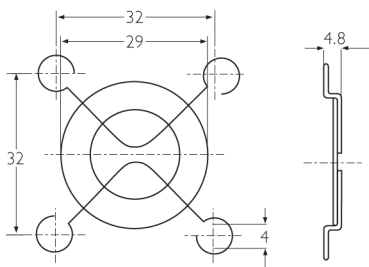

LZ29-1 Rust resistant steel wire.
4xxx series fans

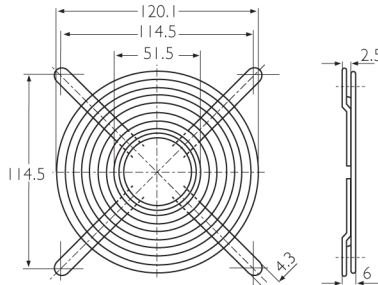

LZ35 Rust resistant steel wire.
5xxx series fans

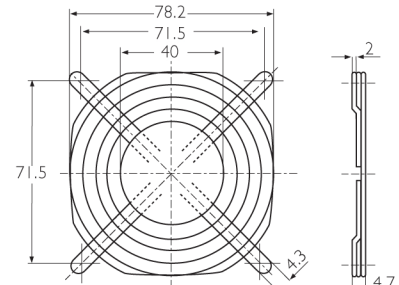

LZ32-4 Rust resistant steel wire.
8xxx series fans

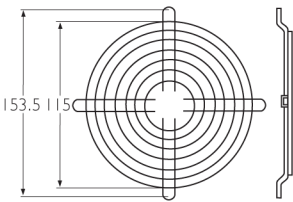

LZ30 Welded steel guard, chromium.
4xxx and 9xxx series fans

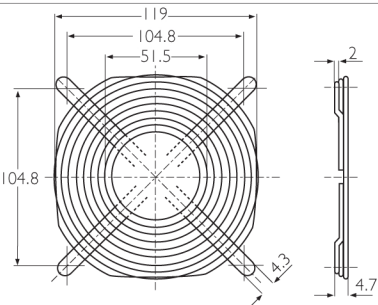

LZ30-4 Rust resistant steel wire.
4xxx and 9xxx series fans

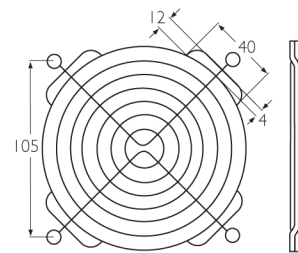

LZ30GB Welded steel guard, chromium.
4xxx and 9xxx series fans

All measurements in mm.

X-ON Electronics

Largest Supplier of Electrical and Electronic Components

Click to view similar products for [Fan Accessories](#) category:

Click to view products by [ebm papst](#) manufacturer:

Other Similar products are found below :

[LZ31](#) [LZ32P-1](#) [63070-2-4013](#) [71882-2-4053](#) [73770-2-3634](#) [73806-2-3634](#) [73816-2-3634](#) [854589-1](#) [99485901](#) [99485904](#) [1-21002-3](#) [1247-4-6254](#) [RF119](#) [1434-4-6711-80](#) [1434-4-6711-1](#) [169-002](#) [KM36](#) [27453.32193](#) [27453.32262](#) [99485906](#) [99485912](#) [F92-B](#) [FG92-W2](#) [FK120-30](#) [FK40-30](#) [FK80-45](#) [27453.32241](#) [27453.32298](#) [R88ACPU001M1](#) [R88ACPU001M2](#) [LZ215](#) [LZ22-2](#) [LZ24B](#) [LZ37-2](#) [525-00-0009](#) [KM38](#) [420-05-0276](#) [50824-4-1040](#) [04.846.1353.0](#) [04.846.1453.0](#) [055032](#) [07100-40](#) [07190-50](#) [08195](#) [08245](#) [09325-M/60](#) [09494-2-4039](#) [09576-2-4013](#) [109-1102](#) [109-019H](#)