

Surface Mount Specialty Polymer Solid Aluminum Electrolytic Capacitors

NSP Series

FEATURES

- NEW "X", "Y", "Z", "U" & "V" TYPE HIGH RIPPLE CURRENT/VERY LOW ESR
- REPLACES MULTIPLE TANTALUM CHIPS IN HIGH CURRENT POWER SUPPLIES AND VOLTAGE REGULATORS
- FITS EIA (7343) "D" AND "E" TANTALUM CHIP LAND PATTERNS
- Pb-FREE AND COMPATIBLE WITH REFLOW SOLDERING

**EXTENDED LOAD LIFE
HIGH RIPPLE CURRENT
ULTRA LOW ESR**

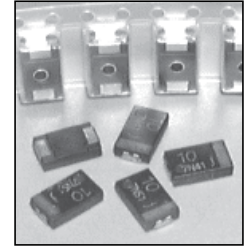

CHARACTERISTICS (Note 1)

Rated Working Range	2.0 ~ 6.3VDC	LOW ESR COMPONENT SOLID POLYMER ELECTROLYTE For Performance Data see www.LowESR.com	
Rated Capacitance Range	82 ~ 560 μ F		
Operating Temperature Range	-55 ~ +105°C		
Capacitance Tolerance	\pm 20% (M)		
Max. Leakage Current (μ A) After 2 Minutes (+20°C)	All Case Sizes	See Standard Products and Specifications Tables	
Max. Tan δ , 120Hz, +20°C			
High Temperature Load Life 2,000 Hours @ 105°C at Rated Working Voltage	Capacitance Change	Within \pm 20% of initial measured value	
	Tan δ	Less than 200% specified max. value	
	Leakage Current	Less than 300% specified max. value	
Damp Heat Test 500 Hours @ +60°C at 90 ~ 95% RH and Rated Working Voltage	Capacitance Change	6.3V	Within -20%/+50% of initial measured value
		4V	Within -20%/+60% of initial measured value
		2V, 2.5V	Within -20%/+70% of initial measured value
	Tan δ	Less than 200% of specified max. value	
	Leakage Current	Less than specified max. value	

Note 1: Specifications that apply to "Not Recommended" parts begin on page 5.

STANDARD PRODUCTS AND SPECIFICATIONS

NIC Part Number	WV (Vdc)	Cap. (μ F)	Max. LC (μ A)	Tan δ	Max. Ripple Current +45°C & 100KHz (mArms)	Max. ESR +20°C & 100KHz (Ω)	Height H
NSP181M2D6ZATRF	2.0	180	36.0	0.06	6,300	0.009	1.9 \pm 0.1
NSP221M2D6ATRF		220	44.0	0.06	5,100	0.015	1.9 \pm 0.1
NSP221M2D6ZATRF		220	44.0	0.06	6,300	0.009	1.9 \pm 0.1
NSP271M2D6XATRF		270	54.0	0.06	5,600	0.012	1.9 \pm 0.1
NSP271M2D6ZATRF		270	54.0	0.06	6,300	0.009	1.9 \pm 0.1
NSP271M2D6YATRF		270	54.0	0.06	7,500	0.006	1.9 \pm 0.1
NSP271M2D6UATRF		270	54.0	0.06	8,500	0.0045	1.9 \pm 0.1
NSP331M2D6ATRF		330	66.0	0.06	5,100	0.015	1.9 \pm 0.1
NSP331M2D6XATRF		330	66.0	0.06	5,600	0.012	1.9 \pm 0.1
NSP331M2D6ZATRF		330	66.0	0.06	6,300	0.009	1.9 \pm 0.1
NSP331M2D6YATRF		330	66.0	0.06	7,500	0.006	1.9 \pm 0.1
NSP331M2D6UATRF		330	66.0	0.06	8,500	0.0045	1.9 \pm 0.1
NSP331M2D6VATRF		330	66.0	0.06	10,200	0.003	1.9 \pm 0.1
NSP391M2D6ATRF		390	78.0	0.06	5,100	0.015	1.9 \pm 0.1
NSP391M2D6ZATRF		390	78.0	0.06	6,300	0.009	1.9 \pm 0.1
NSP391M2D6YATRF		390	78.0	0.06	7,500	0.006	1.9 \pm 0.1
NSP391M2D6UATRF		390	78.0	0.06	8,500	0.0045	1.9 \pm 0.1
NSP471M2D6ATRF		470	94.0	0.06	5,100	0.015	1.9 \pm 0.1
NSP471M2D6ZATRF		470	94.0	0.06	6,300	0.009	1.9 \pm 0.1
NSP471M2D6YATRF		470	94.0	0.06	7,500	0.006	1.9 \pm 0.1
NSP471M2D6UATRF		470	94.0	0.06	8,500	0.0045	1.9 \pm 0.1
NSP471M2D6VATRF		470	94.0	0.06	10,200	0.003	1.9 \pm 0.1
NSP561M2D6ATRF		560	112.0	0.06	5,100	0.015	1.9 \pm 0.1
NSP561M2D6UATRF		560	112.0	0.06	8,500	0.0045	1.9 \pm 0.1
NSP561M2D6VATRF	560	112.0	0.06	10,200	0.003	1.9 \pm 0.1	
NSP151M2.5D6ZATRF	2.5	150	37.5	0.06	6,300	0.009	1.9 \pm 0.1
NSP181M2.5D6ZATRF		180	45.0	0.06	6,300	0.009	1.9 \pm 0.1
NSP221M2.5D6ATRF		220	55.0	0.06	5,100	0.015	1.9 \pm 0.1
NSP221M2.5D6ZATRF		220	55.0	0.06	6,300	0.009	1.9 \pm 0.1
NSP221M2.5D6YATRF		220	55.0	0.06	7,000	0.007	1.9 \pm 0.1
NSP271M2.5D6YATRF		270	67.5	0.06	7,000	0.007	1.9 \pm 0.1
NSP331M2.5D6ATRF		330	82.5	0.06	5,100	0.015	1.9 \pm 0.1
NSP331M2.5D6ZATRF		330	82.5	0.06	6,300	0.009	1.9 \pm 0.1
NSP331M2.5D6YATRF		330	82.5	0.06	7,500	0.006	1.9 \pm 0.1
NSP331M2.5D6UATRF		330	82.5	0.06	8,500	0.0045	1.9 \pm 0.1



Surface Mount Specialty Polymer Solid Aluminum Electrolytic Capacitors

NSP Series

STANDARD PRODUCTS AND SPECIFICATIONS

NIC Part Number	WV	Cap.	Max. LC	Tan δ	Max. Ripple Current +45°C & 100KHz (mA _{rms})	Max. ESR +20°C & 100KHz (Ω)	Height H	
	(Vdc)	(μ F)	(μ A)					
NSP391M2.5D6ATRF	2.5	390	97.5	0.06	5,100	0.015	1.9±0.1	
NSP391M2.5D6ZATRF		390	97.5	0.06	6,300	0.009	1.9±0.1	
NSP391M2.5D6YATRF		390	97.5	0.06	7,500	0.006	1.9±0.1	
NSP391M2.5D6UATRF		390	97.5	0.06	8,500	0.0045	1.9±0.1	
NSP471M2.5D6ATRF		470	117.5	0.06	5,100	0.015	1.9±0.1	
NSP471M2.5D6ZATRF		470	117.5	0.06	6,300	0.009	1.9±0.1	
NSP471M2.5D6YATRF		470	117.5	0.06	7,500	0.006	1.9±0.1	
NSP471M2.5D6UATRF		470	117.5	0.06	8,500	0.0045	1.9±0.1	
NSP471M2.5D6VATRF	470	117.5	0.06	10,200	0.003	1.9±0.1		
NSP820M4D6ZATRF	4.0	82	32.8	0.06	6,300	0.009	1.9±0.1	
NSP101M4D6ZATRF		100	40.0	0.06	6,300	0.009	1.9±0.1	
NSP151M4D6ATRF		150	60.0	0.06	5,100	0.015	1.9±0.1	
NSP151M4D6ZATRF		150	60.0	0.06	6,300	0.009	1.9±0.1	
NSP151M4D6YATRF		150	60.0	0.06	7,000	0.007	1.9±0.1	
NSP181M4D6ATRF		180	72.0	0.06	5,100	0.015	1.9±0.1	
NSP181M4D6XATRF		180	72.0	0.06	5,600	0.012	1.9±0.1	
NSP181M4D6ZATRF		180	72.0	0.06	6,300	0.009	1.9±0.1	
NSP221M4D6ATRF		220	88.0	0.06	5,100	0.015	1.9±0.1	
NSP221M4D6XATRF		220	88.0	0.06	5,600	0.012	1.9±0.1	
NSP221M4D6ZATRF		220	88.0	0.06	6,300	0.009	1.9±0.1	
NSP271M4D6ATRF		270	108.0	0.06	5,100	0.015	1.9±0.1	
NSP271M4D6ZATRF		270	108.0	0.06	6,300	0.009	1.9±0.1	
NSP331M4D6ATRF		330	132.0	0.06	5,100	0.015	1.9±0.1	
NSP101M6.3D6ATRF		6.3	100	63.0	0.06	5,100	0.015	1.9±0.1
NSP121M6.3D6ATRF			120	75.6	0.06	5,100	0.015	1.9±0.1
NSP121M6.3D6ZATRF	120		75.6	0.06	7,000	0.007	1.9±0.1	
NSP151M6.3D6ATRF	150		94.5	0.06	5,100	0.015	1.9±0.1	
NSP151M6.3D6XATRF	150		94.5	0.06	5,600	0.012	1.9±0.1	
NSP151M6.3D6ZATRF	150		94.5	0.06	6,300	0.009	1.9±0.1	
NSP181M6.3D6ATRF	180		113.4	0.06	5,100	0.015	1.9±0.1	
NSP181M6.3D6ZATRF	180		113.4	0.06	6,300	0.009	1.9±0.1	
NSP221M6.3D6ATRF	220	138.0	0.06	5,100	0.015	1.9±0.1		

RIPPLE CURRENT TEMPERATURE CORRECTION FACTORS

Case Code	≤ +45°C	>+45°C ~ ≤+85°C	>+85°C ~ +105°C
All	1.0	0.7	0.25

PART NUMBERING SYSTEM

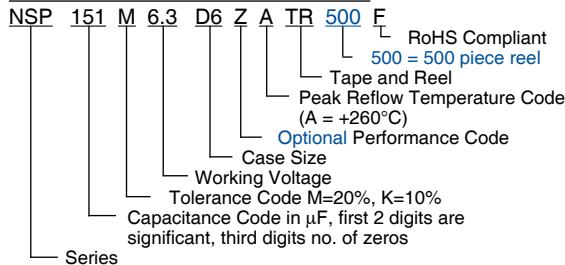

PRECAUTIONS

Please review the notes on correct use, safety and precautions found on pages T10 & T11 of NIC's Electrolytic Capacitor catalog.
 Also found at www.niccomp.com/precautions
 If in doubt or uncertainty, please review your specific application - process details with NIC's technical support personnel: tpmg@niccomp.com



Surface Mount Specialty Polymer Solid Aluminum Electrolytic Capacitors

NSP Series

RECOMMENDED 260°C REFLOW SOLDERING PROFILE

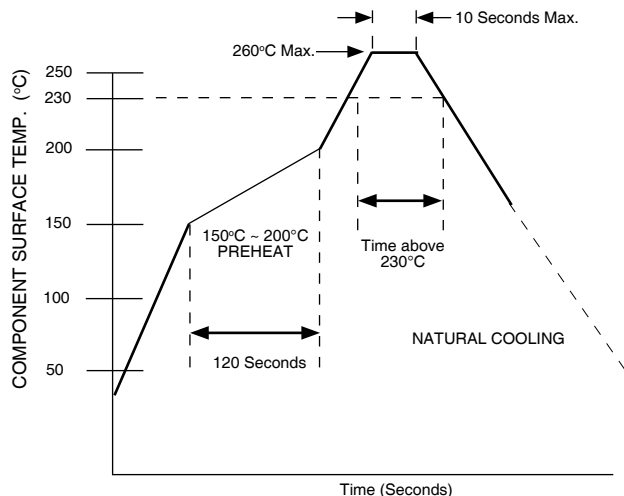

RECOMMENDED LAND PATTERNS (mm)

Case Code	A	B	C
D6	2.8	4.0	8.8

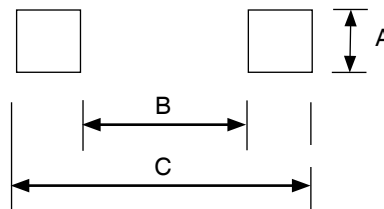

Please note the NSP series will fit on standard "D" and "E" size (7343) tantalum chip capacitor land patterns

DURATION ABOVE 230°C (FOR 260°C REFLOW PARTS)

If Peak Soldering Temperature is	Maximum Time Above +230°C is
260°C, 10 seconds max.	40 seconds
255°C, 10 seconds max.	50 seconds
250°C, 10 seconds max.	60 seconds

Notes:

1. SAC alloy (+217°C) reflow soldering compatible
2. Soldering heat limits apply to the top surface of component
3. If you have concerns about your reflow soldering profile review them with NIC to insure compatible [tpmg@niccomp.com]
4. Two passes through the reflow process are allowed (cooling down period between process).

DIMENSIONS (mm)

Case Code	L ± 0.2	W ± 0.2	H	W1 ± 0.1	S ± 0.3
D6	7.3	4.3	see values table	2.4	1.3

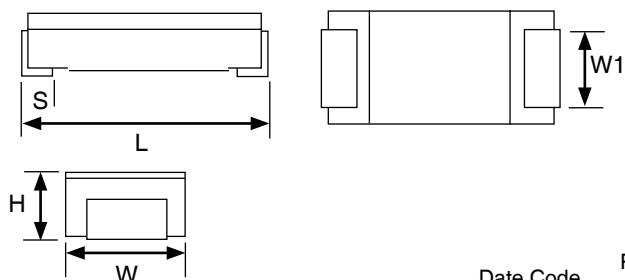

VOLTAGE CODES

Voltage	Code
2.0Vdc	D
2.5Vdc	E
4.0Vdc	G
6.3Vdc	J

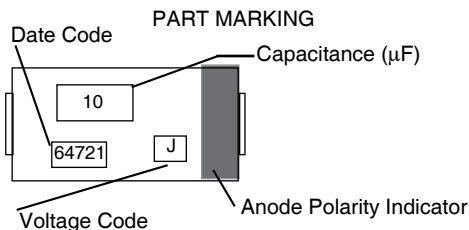

Surface Mount Specialty Polymer Solid Aluminum Electrolytic Capacitors

NSP Series

CARRIER TAPE DIMENSIONS (mm)

Case Code	A±0.2	B±0.2	Dφ	E±0.1	F±0.1	P ₀ ±0.1	P ₁ ±0.1	t±0.2	W±0.3
D6	7.7	4.6	1.5 ^{+0.1}	5.50	1.75	4.0	8.0	2.4	12.0

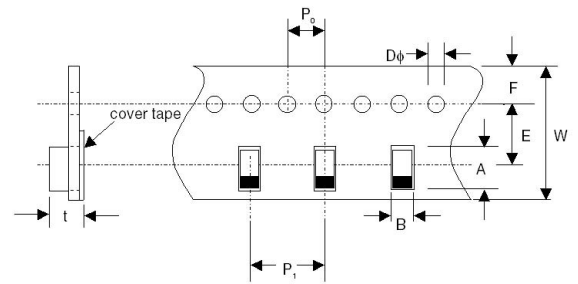

REEL DIMENSIONS (mm)

A±2.0	B min.	C±0.5	D±0.8	E±0.5	T±1.0	t	W±1.0
330	80	13.0	21.0	2.0	20.0	3.0	14

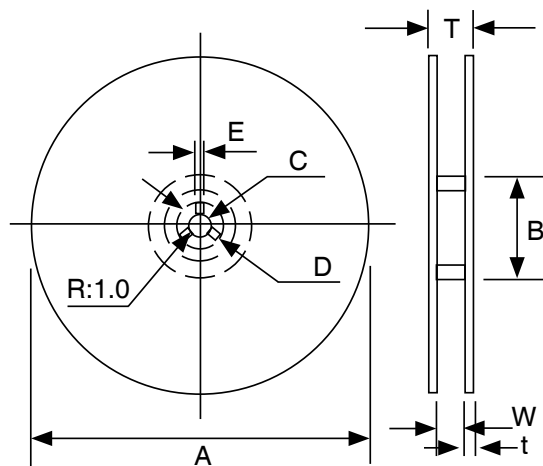

Case Code	Reel Quantity
D6	3,500



Surface Mount Specialty Polymer Solid Aluminum Electrolytic Capacitors

NSP Series

Not Recommended for New Designs

Note: The following parts are supported but not recommended for new designs

FEATURES

- PERFORMANCE CODES "X", "Y" & "Z" (HIGH RIPPLE CURRENT/LOW ESR)
- REPLACES MULTIPLE TANTALUM CHIPS IN HIGH CURRENT POWER SUPPLIES AND VOLTAGE REGULATORS
- FITS EIA (7343) "D" AND "E" TANTALUM CHIP LAND PATTERNS
- Pb-FREE AND COMPATIBLE WITH REFLOW SOLDERING

EXTENDED LOAD LIFE
HIGH RIPPLE CURRENT
ULTRA LOW ESR

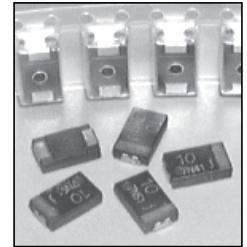

CHARACTERISTICS

Rated Working Range	2.0 ~ 16VDC	LOW ESR COMPONENT SOLID POLYMER ELECTROLYTE For Performance Data see www.LowESR.com	
Rated Capacitance Range	2.2 ~ 560 μ F		
Operating Temperature Range	-40 ~ +105°C		
Capacitance Tolerance	\pm 20% (M)		
Max. Leakage Current (μ A) After 2 Minutes (+20°C)	All Case Sizes	See Standard Products and Specifications Tables	
Max. Tan δ , 120Hz, +20°C			
High Temperature Load Life 1,000 Hours @ 105°C at Rated Working Voltage	Capacitance Change	Within \pm 10% of initial measured value	
	Tan δ	Less than specified max. value	
	Leakage Current	Less than specified max. value	
Damp Heat Test 500 Hours @ +60°C at 90 ~ 95% RH and Rated Working Voltage	Capacitance Change	8V ~ 16V	Within -20%/+40% of initial measured value
		6.3V	Within -20%/+50% of initial measured value
		4V	Within -20%/+60% of initial measured value
		2V, 2.5V	Within -20%/+70% of initial measured value
	Tan δ	Less than 200% of specified max. value	
Leakage Current	Less than specified max. value		

PART NUMBERING SYSTEM

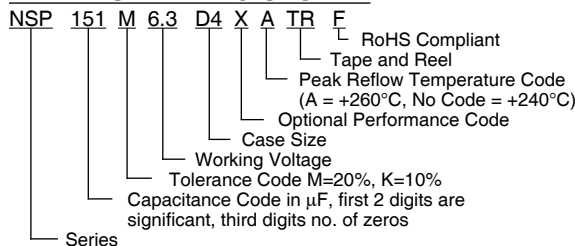

TERMINATION MATERIAL:

- D2 - D5, D3X, D4X Sizes
 - Base: Fe (~ 100 μ m)
 - Under Plating: Cu (~ 5 μ m)
 - Finish Plating: Sn (5 ~ 9 μ m)
- D4Z Sizes
 - Base: Cu (~ 105 μ m)
 - Finish Plating: Sn (5 ~ 9 μ m)



Surface Mount Specialty Polymer Solid Aluminum Electrolytic Capacitors

NSP Series

Not Recommended for New Designs
 Note: The following parts are supported but not recommended for new designs

NIC Part Number (Reflow 240°C)	NIC Part Number (Reflow 260°C)	VV (Vdc)	Cap. (µF)	Max. LC (µA)		Tan δ	Max. Ripple Current +105°C & 100KHz (mArms)	Max. ESR +20°C & 100KHz (Ω)	Height H	
				240°C	260°C					
NSP680M2D5TRF	N/A	2.0	68	8.1	-	0.06	2,000	0.028	1.1±0.1	
N/A	NSP101M2D2ATRF		100	-	20.0	0.06	2,500	0.018	1.8±0.1	
N/A	NSP101M2D2XATRF		100	-	20.0	0.06	2,700	0.015	1.8±0.1	
N/A	NSP101M2D2ZATRF		100	-	20.0	0.06	3,000	0.009	1.8±0.1	
N/A	NSP121M2D2ATRF		120	-	24.0	0.06	2,500	0.018	1.8±0.1	
N/A	NSP121M2D2XATRF		120	-	24.0	0.06	2,700	0.015	1.8±0.1	
N/A	NSP121M2D2ZATRF		120	-	24.0	0.06	3,000	0.009	1.8±0.1	
N/A	NSP151M2D2ATRF		150	-	30.0	0.06	2,500	0.018	1.8±0.1	
N/A	NSP151M2D2ZATRF		150	-	30.0	0.06	3,000	0.009	1.8±0.1	
N/A	NSP181M2D2ATRF		180	-	36.0	0.06	2,500	0.018	1.8±0.1	
N/A	NSP221M2D2ATRF		220	-	26.4	0.06	2,500	0.018	1.8±0.1	
N/A	NSP221M2D2ZATRF		220	-	44.0	0.06	3,000	0.009	1.8±0.1	
N/A	NSP271M2D4ATRF		270	-	54.0	0.10	3,300	0.012	4.2±0.1	
N/A	NSP271M2D4XATRF		270	-	54.0	0.10	3,500	0.010	4.2±0.1	
N/A	NSP331M2D3ATRF		330	-	66.0	0.10	3,000	0.015	2.8±0.2	
N/A	NSP331M2D3XATRF		330	-	66.0	0.10	3,300	0.012	2.8±0.2	
N/A	NSP331M2D3YATRF		330	-	66.0	0.10	3,400	0.009	2.8±0.2	
N/A	NSP331M2D4ATRF		330	-	66.0	0.10	3,300	0.012	4.2±0.1	
N/A	NSP331M2D4XATRF		330	-	66.0	0.10	3,500	0.010	4.2±0.1	
N/A	NSP391M2D3ATRF		390	-	78.0	0.10	3,000	0.015	2.8±0.2	
N/A	NSP391M2D3YATRF		390	-	78.0	0.10	3,400	0.009	2.8±0.2	
N/A	NSP391M2D4ATRF		390	-	78.0	0.10	3,300	0.012	4.2±0.1	
N/A	NSP391M2D4XATRF		390	-	78.0	0.10	3,500	0.010	4.2±0.1	
N/A	NSP391M2D4YATRF		390	-	78.0	0.10	3,700	0.007	4.2±0.1	
N/A	NSP471M2D4ATRF		470	-	94.0	0.10	3,300	0.012	4.2±0.1	
N/A	NSP471M2D3YATRF		470	-	94.0	0.10	3,400	0.009	2.8±0.1	
N/A	NSP471M2D4XATRF		470	-	94.0	0.10	3,500	0.010	4.2±0.1	
N/A	NSP471M2D4YATRF		470	-	94.0	0.10	3,700	0.007	4.2±0.1	
N/A	NSP561M2D4ATRF		560	-	112.0	0.10	3,300	0.012	4.2±0.1	
N/A	NSP561M2D4YATRF		560	-	112.0	0.10	3,700	0.007	4.2±0.1	
NSP560M2.5D5TRF	N/A	2.5	56	8.4	-	0.06	2,000	0.028	1.1±0.1	
N/A	NSP820M2.5D2ATRF		82	-	20.5	0.06	2,500	0.018	1.8±0.1	
N/A	NSP820M2.5D2XATRF		82	-	20.5	0.06	2,700	0.015	1.8±0.1	
N/A	NSP101M2.5D2ATRF		100	-	25.0	0.06	2,500	0.018	1.8±0.1	
N/A	NSP101M2.5D2XATRF		100	-	25.0	0.06	2,700	0.015	1.8±0.1	
N/A	NSP101M2.5D2ZATRF		100	-	25.0	0.06	3,000	0.009	1.8±0.1	
N/A	NSP121M2.5D2ATRF		120	-	30.0	0.06	2,500	0.018	1.8±0.1	
N/A	NSP121M2.5D2ZATRF		120	-	30.0	0.06	3,000	0.009	1.8±0.1	
N/A	NSP151M2.5D2ATRF		150	-	37.5	0.06	2,500	0.018	1.8±0.1	
N/A	NSP151M2.5D2ZATRF		150	-	37.5	0.06	3,000	0.009	1.8±0.1	
N/A	NSP221M2.5D3ATRF		220	-	55.0	0.10	3,000	0.015	2.8±0.2	
N/A	NSP221M2.5D3XATRF		220	-	55.0	0.10	3,300	0.012	2.8±0.2	
N/A	NSP221M2.5D3YATRF		220	-	78.0	0.10	3,400	0.009	2.8±0.2	
N/A	NSP221M2.5D4ATRF		220	-	55.0	0.10	3,300	0.012	4.2±0.1	
N/A	NSP221M2.5D4XATRF		220	-	55.0	0.10	3,500	0.010	4.2±0.1	
N/A	NSP271M2.5D3ATRF		270	-	67.5	0.10	3,000	0.015	2.8±0.2	
N/A	NSP271M2.5D3YATRF		270	-	78.0	0.10	3,400	0.009	2.8±0.2	
N/A	NSP271M2.5D4ATRF		270	-	67.5	0.10	3,300	0.012	4.2±0.1	
N/A	NSP271M2.5D4XATRF		270	-	67.5	0.10	3,500	0.010	4.2±0.1	
N/A	NSP331M2.5D4ATRF		330	-	82.5	0.10	3,300	0.012	4.2±0.1	
N/A	NSP331M2.5D4XATRF		330	-	82.5	0.10	3,500	0.010	4.2±0.1	
N/A	NSP331M2.5D4YATRF		330	-	82.5	0.10	3,700	0.007	4.2±0.1	
N/A	NSP391M2.5D4ATRF		390	-	97.5	0.10	3,300	0.012	4.2±0.1	
N/A	NSP391M2.5D4YATRF		390	-	97.5	0.10	3,700	0.007	4.2±0.1	
N/A	NSP471M2.5D4ATRF		470	-	117.5	0.10	3,300	0.012	4.2±0.1	
N/A	NSP471M2.5D4YATRF		470	-	117.5	0.10	3,700	0.007	4.2±0.1	
NSP390M4D5TRF	N/A		4	39	9.3	-	0.06	2,000	0.028	1.1±0.1
NSP470M4D5TRF	N/A			47	11.3	-	0.06	2,000	0.028	1.1±0.1
N/A	NSP560M4D2ATRF			56	-	22.4	0.06	2,500	0.018	1.8±0.1
N/A	NSP560M4D2XATRF			56	-	22.4	0.06	2,700	0.015	1.8±0.1
N/A	NSP680M4D2ATRF	68		-	27.2	0.06	2,500	0.018	1.8±0.1	

Continue on next page



Surface Mount Specialty Polymer Solid Aluminum Electrolytic Capacitors

NSP Series

Not Recommended for New Designs
 Note: The following parts are supported but not recommended for new designs

NIC Part Number (Reflow 240°C)	NIC Part Number (Reflow 260°C)	WV (Vdc)	Cap. (µF)	Max. LC (µA) 240°C	260°C	Tan δ	Max. Ripple Current +105°C & 100KHz (mArms)	Max. ESR +20°C & 100KHz (Ω)	Height H
N/A	NSP680M4D2XATRF	4.0	68		27.2	0.06	2,700	0.015	1.8±0.1
N/A	NSP820M4D2ATRF		82		32.8	0.06	2,500	0.018	1.8±0.1
N/A	NSP820M4D2XATRF		82		32.8	0.06	2,700	0.015	1.8±0.1
N/A	NSP820M4D2ZATRF		82		32.8	0.06	3,000	0.009	1.8±0.1
N/A	NSP101M4D2ATRF		100		40.0	0.06	1,800	0.018	1.8±0.1
N/A	NSP121M4D3ATRF		120	-	48.0	0.10	3,000	0.015	2.8±0.2
N/A	NSP121M4D3XATRF		120	-	48.0	0.10	3,300	0.012	2.8±0.2
N/A	NSP151M4D3ATRF		150	-	60.0	0.10	3,000	0.015	2.8±0.2
N/A	NSP151M4D3XATRF		150	-	60.0	0.10	3,300	0.012	2.8±0.2
N/A	NSP151M4D3YATRF		150	-	60.0	0.10	3,400	0.009	2.8±0.2
N/A	NSP181M4D3ATRF		180	-	72.0	0.10	2,500	0.018	2.8±0.2
N/A	NSP181M4D4ATRF		180	-	72.0	0.10	3,300	0.012	4.2±0.1
N/A	NSP181M4D3YATRF		180	-	72.0	0.10	3,400	0.009	2.8±0.2
N/A	NSP181M4D4XATRF		180	-	72.0	0.10	3,500	0.010	4.2±0.1
N/A	NSP221M4D4ATRF		220	-	88.0	0.10	3,300	0.012	4.2±0.1
N/A	NSP221M4D4XATRF		220	-	88.0	0.10	3,500	0.010	4.2±0.1
N/A	NSP221M4D4YATRF		220	-	88.0	0.10	3,700	0.007	4.2±0.1
N/A	NSP271M4D4ATRF		270	-	108.0	0.10	3,300	0.012	4.2±0.1
N/A	NSP271M4D4YATRF		270	-	108.0	0.10	3,700	0.007	4.2±0.1
N/A	NSP331M4D4ATRF		330	-	132.0	0.10	3,700	0.012	4.2±0.1
N/A	NSP100M6.3D2ATRF		10		6.3	0.06	1,400	0.055	1.8±0.1
N/A	NSP220M6.3D2ATRF		22		13.9	0.06	1,600	0.040	1.8±0.1
N/A	NSP330M6.3D2ATRF		33		20.8	0.06	2,000	0.028	1.8±0.1
NSP330M6.3D5TRF	N/A		33	8.3	-	0.06	2,000	0.028	1.1±0.1
N/A	NSP470M6.3D2ATRF	47		29.6	0.06	2,500	0.018	1.8±0.1	
N/A	NSP470M6.3D2XATRF	47		29.6	0.06	2,700	0.015	1.8±0.1	
NSP560M6.3D2ZTRF	N/A	56	14.1	-	0.06	3,000	0.009	1.8±0.1	
N/A	NSP680M6.3D2ATRF	68	-	42.8	0.06	2,500	0.018	1.8±0.1	
N/A	NSP680M6.3D2XATRF	68	-	42.8	0.06	2,700	0.015	1.8±0.1	
N/A	NSP101M6.3D3ATRF	100	-	63.0	0.10	3,000	0.015	2.8±0.2	
N/A	NSP101M6.3D3XATRF	100	-	63.0	0.10	3,300	0.012	2.8±0.2	
N/A	NSP121M6.3D3ATRF	120	-	75.6	0.10	3,000	0.015	2.8±0.2	
N/A	NSP121M6.3D3XATRF	120	-	75.6	0.10	3,300	0.012	2.8±0.2	
N/A	NSP151M6.3D3ATRF	150	-	94.5	0.10	2,500	0.018	2.8±0.2	
N/A	NSP151M6.3D4ATRF	150	-	94.5	0.10	3,300	0.012	4.2±0.1	
N/A	NSP151M6.3D4XATRF	150	-	94.5	0.10	3,500	0.010	4.2±0.1	
N/A	NSP181M6.3D4ATRF	180	-	113.4	0.10	3,300	0.012	4.2±0.1	
N/A	NSP181M6.3D4XATRF	180	-	113.4	0.10	3,500	0.010	4.2±0.1	
NSP181M6.3D4YTRF	N/A	180	45.4	-	0.10	3,700	0.007	4.2±0.1	
NSP181M6.3D4ZTRF	N/A	180	45.4	-	0.10	4,000	0.005	4.2±0.1	
N/A	NSP221M6.3D4ATRF	220	-	138.6	0.10	3,000	0.015	4.2±0.1	
N/A	NSP8R2M8D2ATRF	8.2	-	6.3	0.06	1,400	0.055	1.8±0.1	
N/A	NSP150M8D2ATRF	15	-	12.0	0.06	1,600	0.040	1.8±0.1	
N/A	NSP220M8D2ATRF	22	-	17.6	0.06	2,000	0.028	1.8±0.1	
NSP220M8D5TRF	N/A	22	7.0	-	0.06	2,000	0.028	1.1±0.1	
N/A	NSP330M8D2ATRF	33	-	26.4	0.06	2,500	0.018	1.8±0.1	
N/A	NSP470M8D2ATRF	47	-	37.6	0.06	1,800	0.025	1.8±0.1	
N/A	NSP680M8D3ATRF	68	-	54.4	0.10	3,000	0.015	2.8±0.2	
N/A	NSP101M8D3ATRF	100	-	80.0	0.10	2,500	0.018	2.8±0.2	
NSP101M8D4TRF	NSP101M8D4ATRF	100	32.0	80.0	0.10	3,300	0.012	4.2±0.1	
N/A	NSP151M8D4ATRF	150	-	120.0	0.10	3,000	0.015	4.2±0.1	
N/A	NSP220M10D2ATRF	22	-	22.0	0.06	1,600	0.030	1.8±0.1	
N/A	NSP330M10D2ATRF	33	-	33.0	0.06	1,800	0.025	1.8±0.1	
N/A	NSP390M10D2ATRF	39	-	39.0	0.06	1,800	0.025	1.8±0.1	
NSP4R7M12.5D2TRF	N/A	4.7	3.0	-	0.06	1,000	0.080	1.8±0.1	
NSP100M12.5D2TRF	N/A	10	5.0	-	0.06	1,000	0.060	1.8±0.1	
NSP150M12.5D5TRF	N/A	15	7.5	-	0.06	1,400	0.040	1.1±0.1	
NSP150M12.5D2TRF	N/A	15	7.5	-	0.06	1,300	0.050	1.8±0.1	
NSP220M12.5D2TRF	N/A	22	11.0	-	0.06	1,600	0.030	1.8±0.1	
NSP2R2M16D2TRF	N/A	2.2	3.0	-	0.06	1,000	0.110	1.8±0.1	
NSP4R7M16D2TRF	N/A	4.7	3.0	-	0.06	1,000	0.080	1.8±0.1	

Continue on next page



Surface Mount Specialty Polymer Solid Aluminum Electrolytic Capacitors

NSP Series

Not Recommended for New Designs
Note: The following parts are supported but not recommended for new designs

NIC Part Number (Reflow 240°C)	NIC Part Number (Reflow 260°C)	WV (Vdc)	Cap. (μ F)		Max. LC (μ A) 240°C	260°C	Tan δ	Max. Ripple Current +105°C & 100KHz (mA _{rms})	Max. ESR +20°C & 100KHz (Ω)	Height H
			240°C	260°C						
NSP6R8M16D2TRF	N/A	16	6.8	4.4	-	0.06	1,000	0.070	1.8±0.1	
NSP8R2M16D2TRF	N/A		8.2	5.2	-	0.06	1,300	0.045	1.8±0.1	

RECOMMENDED 240°C REFLOW SOLDERING PROFILE

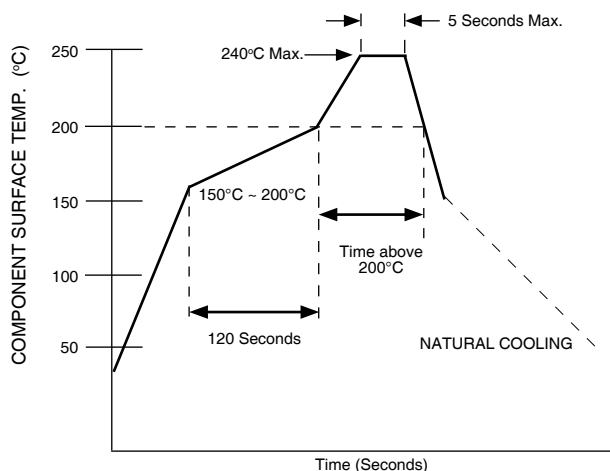

RECOMMENDED 260°C REFLOW SOLDERING PROFILE

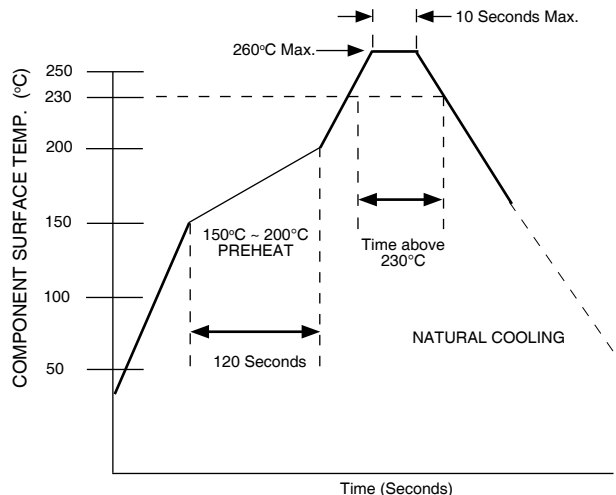

DURATION ABOVE 200°C (FOR 240°C REFLOW PARTS)

If Peak Soldering Temperature is	Maximum Time Above +200°C is
240°C, 5 seconds max.	30 seconds
230°C, 5 seconds max.	40 seconds

DURATION ABOVE 230°C (FOR 260°C REFLOW PARTS)

If Peak Soldering Temperature is	Maximum Time Above +230°C is
260°C, 10 seconds max.	40 seconds
255°C, 10 seconds max.	50 seconds
250°C, 10 seconds max.	60 seconds

Notes:

1. SAC alloy (+217°C) reflow soldering compatible
2. Soldering heat limits apply to the top surface of component
3. If you have concerns about your reflow soldering profile review them with NIC to insure compatible [tpmg@niccomp.com]
4. Two passes through the reflow process are allowed (cooling down period between process).



Surface Mount Specialty Polymer Solid Aluminum Electrolytic Capacitors

NSP Series

DIMENSIONS (mm)

Case Code	L ±0.4	W ±0.3	H	W1 ±0.2	S ±0.3
D2 ~ D6	7.3	4.3	see values table	2.4	1.3

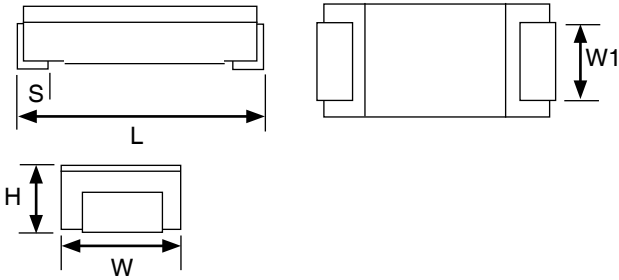

VOLTAGE CODES

Voltage	Code
2.0Vdc	D
2.5Vdc	E
4.0Vdc	G
6.3Vdc	J
8Vdc	K
10Vdc	A
12.5Vdc	B
16Vdc	C

RECOMMENDED LAND PATTERNS (mm)

Case Code	A	B	C
D2 ~ D6	2.8	4.0	8.8

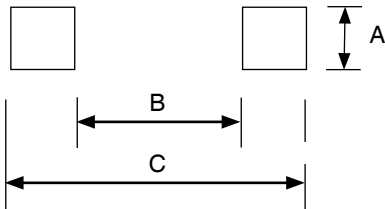

Please note the NSP series will fit on standard "D" and "E" size (7343) tantalum chip capacitor land patterns

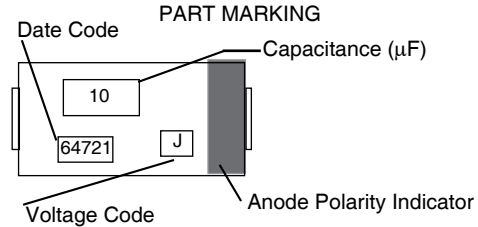

CARRIER TAPE DIMENSIONS (mm)

Case Code	A±0.2	B±0.2	Dφ	E±0.1	F±0.1	P _o ±0.1	P _i ±0.1	t±0.2	W±0.3
D5	7.7	4.6	1.5 ^{+0.1}	5.50	1.75	4.0	8.0	1.5	12.0
D2, D6								2.4	
D3								3.5	
D4								4.3	

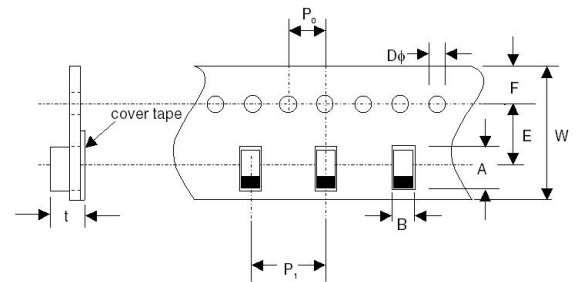

REEL DIMENSIONS (mm)

A±2.0	B min.	C±0.5	D±0.8	E±0.5	T±1.0	t	W±1.0
330	80	13.0	21.0	2.0	20.0	3.0	14

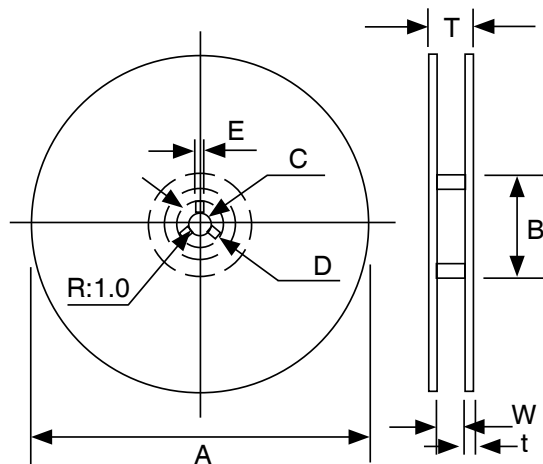

Case Code	Reel Quantity
D5, D6, D2	3,500
D3, D4	2,000



X-ON Electronics

Largest Supplier of Electrical and Electronic Components

Click to view similar products for [Aluminum Organic Polymer Capacitors](#) category:

Click to view products by [NIC](#) manufacturer:

Other Similar products are found below :

[D38999/20WJ43SN-LC](#) [750-1809](#) [MS27467T25F24P](#) [176P12](#) [SEAU0A0102G](#) [BTM-16-513](#) [MS3470W8-33P L/C](#) [MAL218497702E3](#)
[MAL218497801E3](#) [MAL218397005E3](#) [MAL218297003E3](#) [MAL218397603E3](#) [MAL218297802E3](#) [MAL218497701E3](#) [MAL218697502E3](#)
[MAL218397102E3](#) [MAL218297804E3](#) [MAL218497902E3](#) [MAL218497804E3](#) [MAL218297001E3](#) [MAL218697005E3](#) [MAL218697509E3](#)
[MAL218397806E3](#) [MAL218297603E3](#) [MAL218397604E3](#) [MAL218697106E3](#) [MAL218297005E3](#) [MAL218397106E3](#) [MAL218297103E3](#)
[MAL218697108E3](#) [MAL218497903E3](#) [MAL218497703E3](#) [MAL218297701E3](#) [MAL218297101E3](#) [MAL218397104E3](#) [MAL218397801E3](#)
[MAL218297604E3](#) [MAL218397803E3](#) [MAL218697601E3](#) [MAL218697554E3](#) [MAL218697607E3](#) [MAL218397805E3](#) [MAL218297105E3](#)
[MAL218397702E3](#) [MAL218697104E3](#) [MAL218297702E3](#) [MAL218497901E3](#) [MAL218497806E3](#) [MAL218697001E3](#) [EEF-CX0J221YR](#)