

# OLED DISPLAY MODULE

## Product Specification

|                          |                      |             |
|--------------------------|----------------------|-------------|
| <b>CUSTOMER</b>          | <b>Standard</b>      |             |
| <b>PRODUCT NUMBER</b>    | <b>DD-12864YO-5A</b> |             |
| <b>CUSTOMER APPROVAL</b> |                      | <b>Date</b> |

| INTERNAL APPROVALS |                        |                     |
|--------------------|------------------------|---------------------|
| Product Mgr        | Doc. Control           | Electr. Eng         |
| <b>Elijah Ebo</b>  | <b>Anthony Perkins</b> | <b>Bazile Peter</b> |
| Date: 03 Dec 07    | Date: 03 Dec 07        | Date: 03 Dec 07     |

## TABLE OF CONTENTS

|          |   |           |
|----------|---|-----------|
| <b>1</b> | <b>MAIN FEATURES .....</b>                        | <b>4</b>  |
| <b>2</b> | <b>MECHANICAL SPECIFICATION .....</b>             | <b>5</b>  |
| 2.1      | MECHANICAL CHARACTERISTICS .....                  | 5         |
| 2.2      | MECHANICAL DRAWING .....                          | 6         |
| <b>3</b> | <b>ELECTRICAL SPECIFICATION.....</b>              | <b>7</b>  |
| 3.1      | ABSOLUTE MAXIMUM RATINGS .....                    | 7         |
| 3.2      | ELECTRICAL CHARACTERISTICS .....                  | 8         |
| 3.3      | INTERFACE PIN ASSIGNMENT .....                    | 9         |
| 3.4      | TIMING CHARACTERISTICS .....                      | 12        |
| <b>4</b> | <b>OPTICAL SPECIFICATION.....</b>                 | <b>15</b> |
| 4.1      | OPTICAL CHARACTERISTICS.....                      | 15        |
| <b>5</b> | <b>FUNCTIONAL SPECIFICATION .....</b>             | <b>16</b> |
| 5.1      | COMMANDS .....                                    | 16        |
| 5.2      | POWER UP/DOWN SEQUENCE.....                       | 16        |
| 5.3      | RESET CIRCUIT .....                               | 16        |
| 5.4      | ACTUAL APPLICATION EXAMPLE.....                   | 17        |
| <b>6</b> | <b>PACKAGING AND LABELLING SPECIFICATION.....</b> | <b>18</b> |
| <b>7</b> | <b>QUALITY ASSURANCE SPECIFICATION .....</b>      | <b>19</b> |
| 7.1      | CONFORMITY .....                                  | 19        |
| 7.2      | DELIVERY ASSURANCE .....                          | 19        |
| 7.3      | DEALING WITH CUSTOMER COMPLAINTS .....            | 23        |
| <b>8</b> | <b>RELIABILITY SPECIFICATION .....</b>            | <b>24</b> |
| 8.1      | RELIABILITY TESTS .....                           | 24        |
| 8.2      | LIFE TIME.....                                    | 24        |
| <b>9</b> | <b>HANDLING PRECAUTIONS.....</b>                  | <b>25</b> |

|             |               |        |
|-------------|---------------|--------|
| Product No. | DD-12864YO-5A | REV. A |
|             |               |        |

|      |        |
|------|--------|
| Page | 2 / 25 |
|------|--------|

REVISION RECORD

| <b>Rev.</b> | <b>Date</b> | <b>Page</b> | <b>Chapt.</b> | <b>Comment</b> | <b>ECR no.</b> |
|-------------|-------------|-------------|---------------|----------------|----------------|
| A           | 03 Dec 07   |             |               | First Issue    |                |
|             |             |             |               |                |                |
|             |             |             |               |                |                |
|             |             |             |               |                |                |
|             |             |             |               |                |                |
|             |             |             |               |                |                |
|             |             |             |               |                |                |
|             |             |             |               |                |                |

|             |               |        |
|-------------|---------------|--------|
| Product No. | DD-12864YO-5A | REV. A |
|             |               |        |

|      |        |
|------|--------|
| Page | 3 / 25 |
|------|--------|

# 1 MAIN FEATURES

| ITEM                  | CONTENTS                |
|-----------------------|-------------------------|
| Display Format        | 128 x 64 Dots           |
| Overall Dimensions    | 73.00 x 41.86 x 2.00 mm |
| Colour                | Monochrome Yellow       |
| Active Area           | 61.41 x 30.69 mm        |
| Viewing Area          | 63.41 x 32.69mm         |
| Display Mode          | Passive Matrix (2.70")  |
| Driving Method        | 1/64 duty               |
| Driver IC             | SSD1325                 |
| Operating temperature | -30 ~ +70               |
| Storage temperature   | -40 ~ +80               |

|             |               |        |
|-------------|---------------|--------|
| Product No. | DD-12864YO-5A | REV. A |
|             |               |        |

|      |        |
|------|--------|
| Page | 4 / 25 |
|------|--------|

## 2 MECHANICAL SPECIFICATION

### 2.1 MECHANICAL CHARACTERISTICS

---

| ITEM                 | CHARACTERISTIC       | UNIT |
|----------------------|----------------------|------|
| Display Format       | 128 x 64 Dots        | Dots |
| Overall Dimensions   | 73.00 x 41.86 x 2.00 | mm   |
| Viewing Area         | 63.41 x 32.69        | mm   |
| Active Area          | 61.41 x 30.69        | mm   |
| Dot Size             | 0.45 x 0.45          | mm   |
| Dot Pitch            | 0.48 x 0.48          | mm   |
| Weight               | 21                   | g    |
| IC Controller/Driver | SSD1325              |      |

|             |               |        |
|-------------|---------------|--------|
| Product No. | DD-12864YO-5A | REV. A |
|             |               |        |

|      |        |
|------|--------|
| Page | 5 / 25 |
|------|--------|

## 2.2 MECHANICAL DRAWING

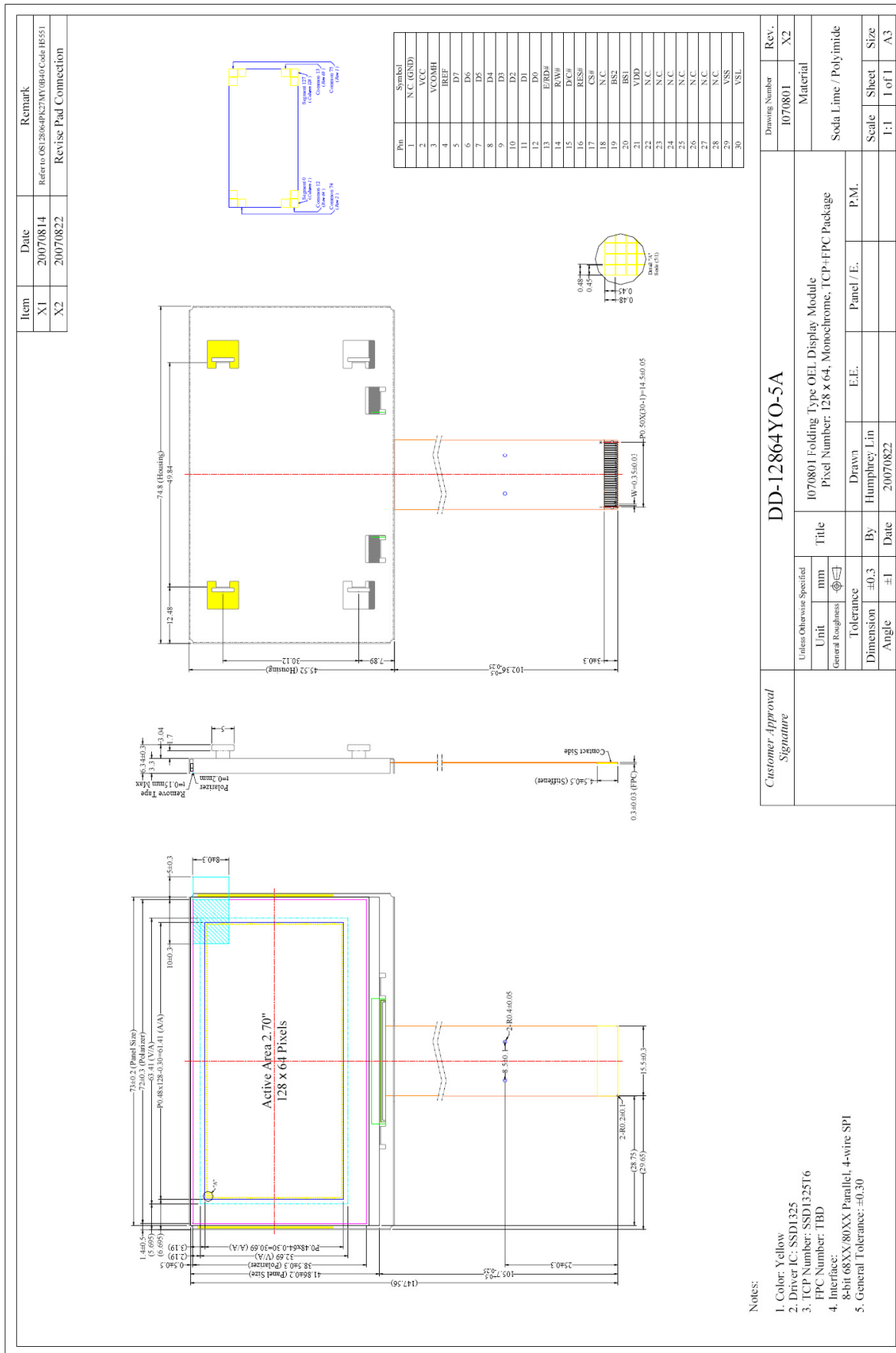

|                    |               |        |
|--------------------|---------------|--------|
| <b>Product No.</b> | DD-12864YO-5A | REV. A |
|--------------------|---------------|--------|

|             |        |
|-------------|--------|
| <b>Page</b> | 6 / 25 |
|-------------|--------|

### 3 ELECTRICAL SPECIFICATION

#### 3.1 ABSOLUTE MAXIMUM RATINGS

VSS = 0 V, Ta = 25 °C

| Item                       | Symbol  | Min  | Max | Unit | Note      |
|----------------------------|---|------|-----|------|-----------|
| Supply Voltage for logic   | V <sub>DD</sub>                                       | -0.3 | 4.0 | V    | Note 1, 2 |
| Supply voltage for Display | V <sub>CC</sub>                                       | 0    | 16  | V    |           |
| Operating Temperature      | Top   | -30  | 70  | °C   |           |
| Storage Temperature        | Tst   | -40  | 80  | °C   |           |
| Static Electricity         | Be sure that you are grounded when handling displays. |      |     |      |           |

Note 1: All the above voltages are on the basis of “GND=0V”.

Note 2: When this module is used beyond the above absolute maximum ratings, permanent damage to the module may occur. Also for normal operations it's desirable to use this module under the conditions according to Section 3.2 “Electrical Characteristics”. If this module is used beyond these conditions the module may malfunction and the reliability could deteriorate.

### 3.2 ELECTRICAL CHARACTERISTICS

| Characteristics                        | Symbol                | Conditions                         | Min                   | Typ | Max                   | Unit |
|--|-----------------------|------------------------------------|-----------------------|-----|-----------------------|------|
| Supply Voltage                         | V <sub>DD</sub>       |                                    | 2.4                   | 2.8 | 3.5                   | V    |
| Supply Voltage for Display             | V <sub>CC</sub>       | Note 3                             | 14.25                 | 15  | 15.75                 | V    |
| High Level Input                       | V <sub>IH</sub>       | I <sub>OUT</sub> =0.1mA,<br>3.3MHz | 0.8xV <sub>DD</sub>   | -   | V <sub>DD</sub>       | V    |
| Low Level Input                        | V <sub>IL</sub>       |                                    | 0                     | -   | 0.2 x V <sub>DD</sub> | V    |
| High Level Output                      | V <sub>OH</sub>       |                                    | 0.9 x V <sub>DD</sub> | -   | V <sub>DD</sub>       | V    |
| Low Level Output                       | V <sub>OL</sub>       |                                    | 0                     | -   | 0.1 x V <sub>DD</sub> | V    |
| Operating current for V <sub>DD</sub>  | I <sub>DD</sub>       | Note 4                             | -                     | 250 | 400                   | μA   |
|  |                       | Note 5                             | -                     | 250 | 400                   |      |
| Operating current for V <sub>CC</sub>  | I <sub>CC</sub>       | Note 4                             | -                     | 31  | 39                    | mA   |
|  |                       | Note 5                             | -                     | 53  | 66                    |      |
| Sleep mode current for V <sub>DD</sub> | I <sub>DD SLEEP</sub> |                                    | -                     | 1   | 2                     | μA   |
| Sleep mode current for V <sub>CC</sub> | I <sub>CC SLEEP</sub> |                                    | -                     | 1   | 2                     | μA   |

Note 3 Brightness (L<sub>br</sub>) and Supply Voltage for Display (V<sub>CC</sub>) are subject to the change of the panel characteristics and the customers request

Note 4 V<sub>DD</sub> = 2.8V, V<sub>CC</sub> = 15V, 50% display area turned on.

Note 5 V<sub>DD</sub> = 2.8V, V<sub>CC</sub> = 15V, 100% display area turned on.

|             |               |        |
|-------------|---------------|--------|
| Product No. | DD-12864YO-5A | REV. A |
|             |               |        |

|      |        |
|------|--------|
| Page | 8 / 25 |
|------|--------|



### 3.3 INTERFACE PIN ASSIGNMENT

| No.  | Symbol    | Function  |
|------|-----------|---|
| 1    | N.C.(GND) | <b>Reserved Pin (Supporting Pin)</b><br>The supporting pins can reduce the influences from stresses on the function pins. These pins must be connected to external ground.  |
| 2    | VCC       | <b>Power Supply for OEL Panel</b><br>This is the most positive voltage supply pin of the chip. It can be supplied externally or generated internally by using internal DC/DC voltage converter.   |
| 3    | VCOMH     | <b>Voltage Output High Level for COM Signal</b><br>This pin is the input pin for the voltage output high level for COM signals. It can be supplied externally or internally. When VCOMH is generated internally, a capacitor should be connected between this pin and VSS.  |
| 4    | IREF      | <b>Current Reference for Brightness Adjustment</b><br>This pin is segment current reference pin. A resistor should be connected between this pin and VSS. Set the current at 10 $\mu$ A.  |
| 5~12 | D7~D0     | <b>Host Data Input/Output Bus</b><br>These pins are 8-bit bi-directional data bus to be connected to the microprocessor's data bus. When serial mode is selected, D1 will be the serial data input SDIN and D0 will be the serial clock input SCLK.   |
| 13   | E/RD#     | <b>Read/Write Enable or Read</b><br>This pin is MCU interface input. When interfacing to a 68XX-series microprocessor, this pin will be used as the Enable (E) signal. Read/write operation is initiated when the pin is pulled high and the CS# is pulled low.<br>When connecting to an 80XX-microprocessor, this pin receives the Read (RD#) signal. Data read operation is initiated when this pin is pulled low and CS# is pulled low.  |
| 14   | R/W#      | <b>Read/Write Select or Write</b><br>This pin is MCU interface input. When interfacing to a 68XX-series microprocessor, this pin will be used as Read/Write (R/W#) selection input. Pull this pin to "High" for read mode and pull it "Low" for write mode.<br>When 80XX interface mode is selected, this pin will be the Write (WR#) input. Data write operation is initiated when this pin is pulled low and the CS# is pulled low.   |
| 15   | D/C#      | <b>Data/Command Control</b><br>This pin is Data/Command control pin. When the pin is pulled high, the input at D7~D0 is treated as display data. When the pin is pulled low, the input at D7~D0 will be transferred to the command register. For detail relationship to MCU interface signals, please refer to the Timing Characteristics Diagrams.<br>When the pin is pulled high and serial interface mode is selected, the data at SDIN is treated as data. When it is pulled low, the data at SDIN will be transferred to the command register. |
| 16   | RES#      | <b>Power Reset for Controller and Driver</b><br>This pin is reset signal input. When the pin is low, initialization of the chip is executed.  |
| 17   | CS#       | <b>Chip Select</b><br>This pin is the chip select input. The chip is enabled for MCU communication only when CS# is pulled low.   |
| 18   | N.C.      | No Connection   |

|             |               |        |      |        |
|-------------|---------------|--------|------|--------|
| Product No. | DD-12864YO-5A | REV. A | Page | 9 / 25 |
|             |               |        |      |        |

|       |      |  |               |               |        |
|-------|------|--|---------------|---------------|--------|
| 19    | BS1  | <b>Communicating Protocol Select</b><br>These pins are MCU interface selection input. See the following table:   |               |               |        |
| 20    | BS2  |  | 68XX-parallel | 80XX-parallel | Serial |
|       |      | BS1  | 0             | 1             | 0      |
|       |      | BS2  | 1             | 1             | 0      |
| 21    | VDD  | <b>Power Supply for Logic Circuit</b><br>This is a voltage supply pin. It must be connected to external source.  |               |               |        |
| 22~28 | N.C. | <b>Reserved Pin</b><br>The supporting pins can reduce the influences from stresses on the function pins. These pins must be connected to external ground.  |               |               |        |
| 29    | VSS  | <b>Ground of OEL System</b><br>This is a ground pin. It also acts as a reference for the logic pins, the OEL driving voltages, and the analog circuits. It must be connected to external ground. |               |               |        |
| 30    | VSL  | <b>Voltage Output Low Level for SEG Signal</b><br>This pin is the output for the voltage output low level for SEG signals. A capacitor should be connected between this pin and VSS.             |               |               |        |

|             |               |        |
|-------------|---------------|--------|
| Product No. | DD-12864YO-5A | REV. A |
|             |               |        |

|      |         |
|------|---------|
| Page | 10 / 25 |
|------|---------|

BLOCK DIAGRAM

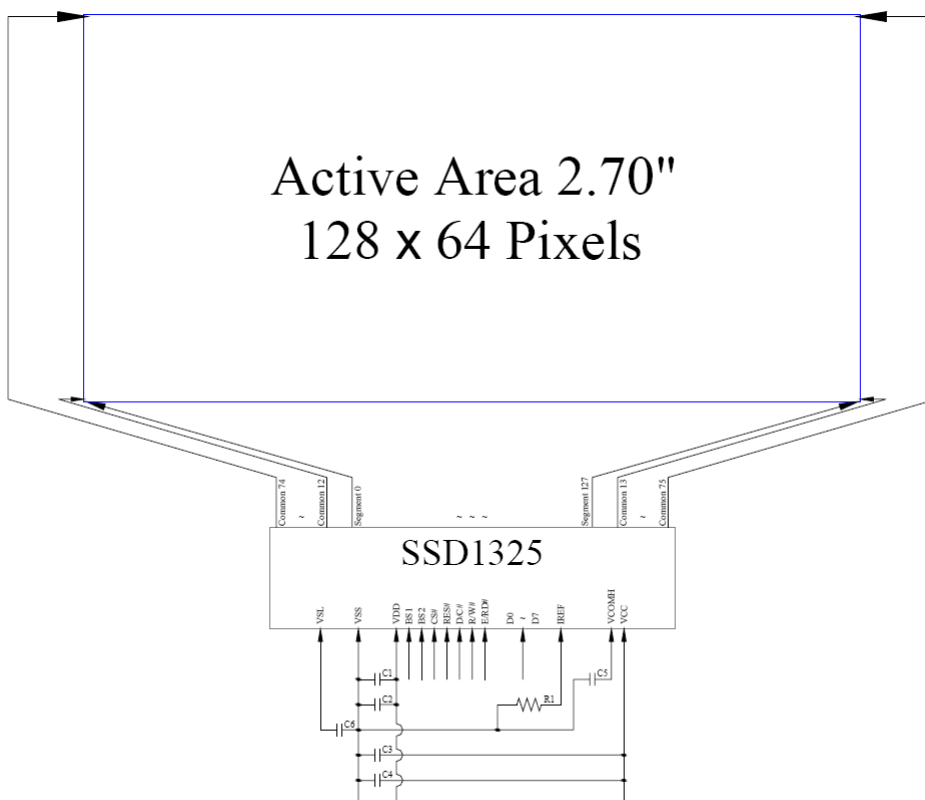

MCU Interface Selection: BS1 and BS2

Pins connected to MCU interface: D7~D0, E/RD#, R/W#, D/C#, RES# and CS#.

C1, C3: 0.1µF

C2, C6: 4.7µF

C4: 10µF

C5: 4.7µF/25V Tantalum Capacitor

R1: 820 kΩ,  $R1 = (\text{Voltage at IREF} - \text{BGGND}) / \text{IREF}$

|             |               |        |
|-------------|---------------|--------|
| Product No. | DD-12864YO-5A | REV. A |
|             |               |        |

|      |         |
|------|---------|
| Page | 11 / 25 |
|------|---------|

### 3.4 TIMING CHARACTERISTICS

#### 3.4.1 AC CHARACTERISTICS

##### 3.4.1.1 68XX-Series MPU Parallel Interface Timing Characteristics

VDD = 2.8V, Ta = 25°C

| Symbol             | Description                                     | Min | Max | Unit |
|--------------------|---|-----|-----|------|
| t <sub>cycle</sub> | System Cycle Time                               | 300 | -   | ns   |
| t <sub>AS</sub>    | Address Setup Time                              | 0   | -   | ns   |
| t <sub>AH</sub>    | Address Hold Time                               | 0   | -   | ns   |
| t <sub>DSW</sub>   | Write Data Setup Time                           | 40  | -   | ns   |
| t <sub>DHW</sub>   | Write Data Hold Time                            | 15  | -   | ns   |
| t <sub>DHR</sub>   | Read Data Hold Time                             | 20  | -   | ns   |
| t <sub>OH</sub>    | Output Disable Time                             | -   | 70  | ns   |
| t <sub>ACC</sub>   | Access Time                                     | -   | 140 | ns   |
| PW <sub>CSL</sub>  | Chip Select Low Pulse Width (Read) Chip Select  | 120 | -   | ns   |
|                    | Low Pulse width (Write)                         | 60  |     |      |
| PW <sub>CSH</sub>  | Chip Select High Pulse Width (Read) Chip Select | 60  | -   | ns   |
|                    | High Pulse Width (Write)                        | 60  |     |      |
| t <sub>R</sub>     | Rise Time                                       | -   | 15  | ns   |
| t <sub>F</sub>     | Fall Time                                       | -   | 15  | ns   |

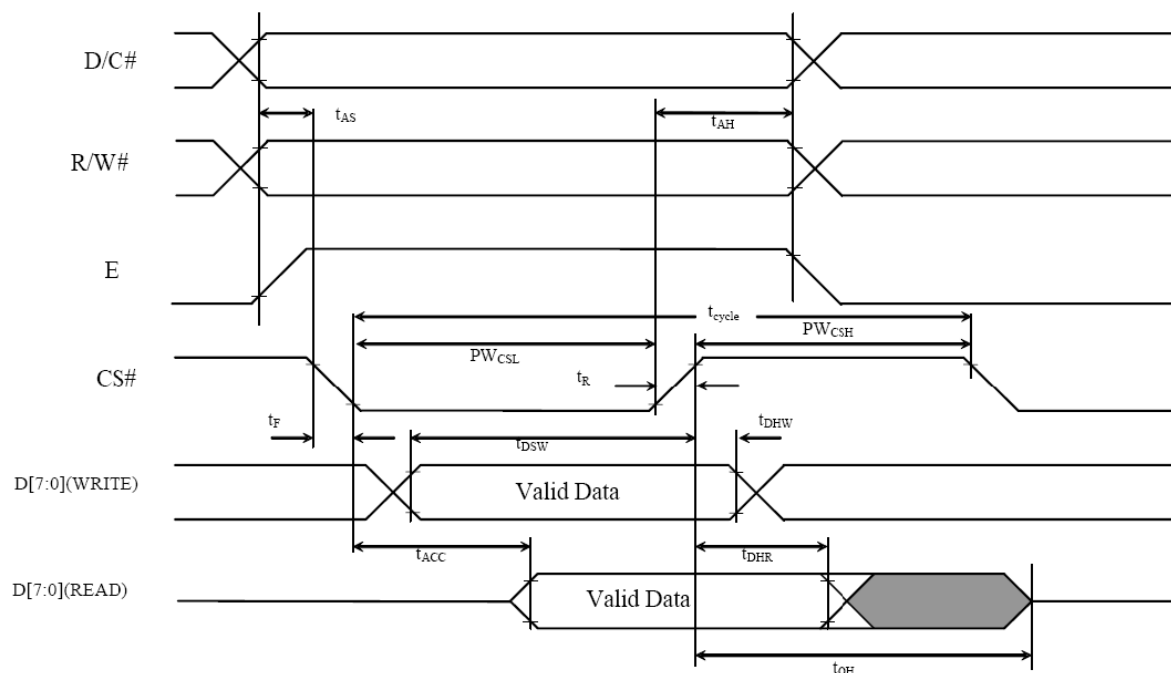

### 3.4.1.2 80XX-Series MPU Parallel Interface Timing Characteristics

| Symbol             | Description                                | Min | Max | Unit |
|--------------------|--|-----|-----|------|
| t <sub>cycle</sub> | Clock Cycle Time                           | 300 | -   | ns   |
| t <sub>AS</sub>    | Address Setup Time                         | 0   | -   | ns   |
| t <sub>AH</sub>    | Address Hold Time                          | 0   | -   | ns   |
| t <sub>DSW</sub>   | Write Data Setup Time                      | 40  | -   | ns   |
| t <sub>DHW</sub>   | Write Data Hold Time                       | 15  | -   | ns   |
| t <sub>DHR</sub>   | Read Data Hold Time                        | 20  | -   | ns   |
| t <sub>OH</sub>    | Output Disable Time                        | -   | 70  | ns   |
| t <sub>ACC</sub>   | Access Time                                | -   | 140 | ns   |
| PW <sub>CSL</sub>  | Chip Select Low Pulse Width (Read)         | 120 | -   | ns   |
|                    | Chip Select Low Pulse Width (Write)        | 60  | -   | ns   |
| PW <sub>CSH</sub>  | Chip Select Setup High Pulse Width (Read)  | 60  | -   | ns   |
|                    | Chip Select Setup High Pulse Width (Write) | 60  | -   | ns   |
| t <sub>R</sub>     | Rise Time                                  | -   | 15  | ns   |
| t <sub>F</sub>     | Fall Time                                  | -   | 15  | ns   |

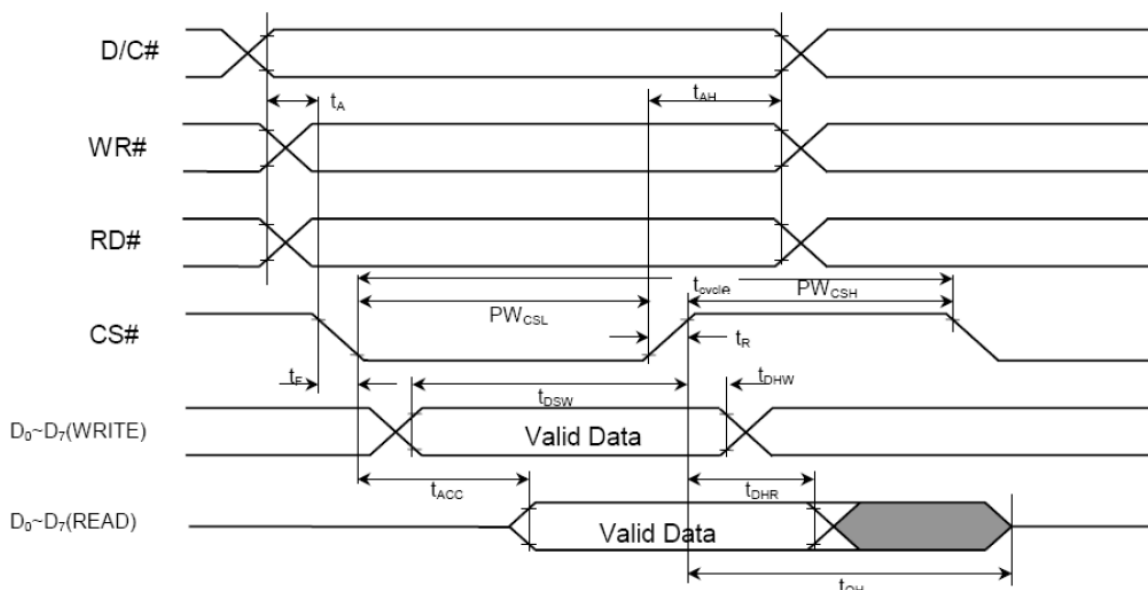

### 3.4.1.3 Serial Interface Timing Characteristics

VDD = 2.8V , Ta = 25°C

| Symbol             | Description            | Min | Max | Unit |
|--------------------|------------------------|-----|-----|------|
| t <sub>cycle</sub> | Clock Cycle Time       | 250 | -   | ns   |
| t <sub>AS</sub>    | Address Setup Time     | 150 | -   | ns   |
| t <sub>AH</sub>    | Address Hold Time      | 150 | -   | ns   |
| t <sub>CSS</sub>   | Chip Select Setup Time | 120 | -   | ns   |
| t <sub>CSH</sub>   | Chip Select Hold Time  | 60  | -   | ns   |
| t <sub>DSW</sub>   | Write Data Setup Time  | 100 | -   | ns   |
| t <sub>DHW</sub>   | Write Data Hold Time   | 100 | -   | ns   |
| t <sub>CLKL</sub>  | Serial Clock Low Time  | 100 | -   | ns   |
| t <sub>CLKH</sub>  | Serial Clock High Time | 100 | -   | ns   |
| t <sub>R</sub>     | Rise Time              | -   | 15  | ns   |
| t <sub>F</sub>     | Fall Time              | -   | 15  | ns   |

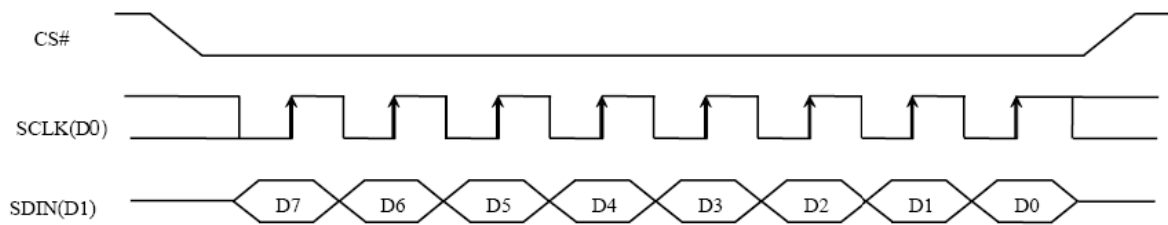
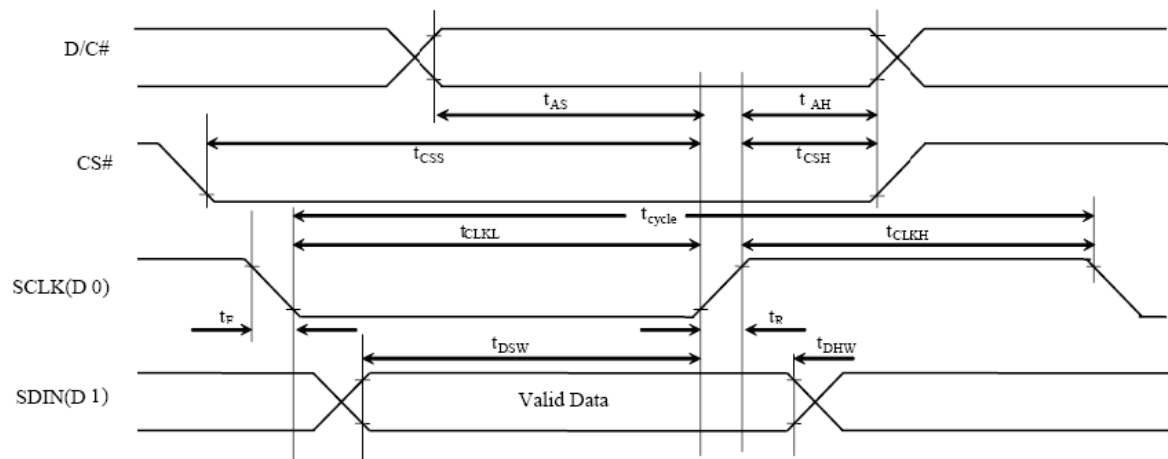

## 4 OPTICAL SPECIFICATION

### 4.1 OPTICAL CHARACTERISTICS

| Characteristics    | Symbol          | Condition                  | Min  | Typ     | Max  | Unit              |
|--------------------|-----------------|----------------------------|------|---------|------|-------------------|
| Brightness(White)  | L <sub>br</sub> | With Polarizer<br>(Note 3) | 70   | 100     | -    | cd/m <sup>2</sup> |
| C.I.E.(White)      | (X)             | Without Polarizer          | 0.44 | 0.48    | 0.52 | -                 |
|                    | (Y)             |                            | 0.47 | 0.51    | 0.55 |                   |
| Dark Room Contrast | CR              |                            | -    | >1000:1 | -    | -                 |
| Viewing Angle      |                 |                            | >160 | -       | -    | degree            |

Optical measurement taken at V<sub>DD</sub> = 2.8V, V<sub>CC</sub> = 15V.  
Software configuration follows Section 4.4 Initialization

|             |               |        |
|-------------|---------------|--------|
| Product No. | DD-12864YO-5A | REV. A |
|             |               |        |

|      |         |
|------|---------|
| Page | 15 / 25 |
|------|---------|

## 5 FUNCTIONAL SPECIFICATION

### 5.1 COMMANDS

Please refer to the Technical Manual for the SSD1325

### 5.2 POWER UP/DOWN SEQUENCE

To protect panel and extend the panel lifetime, the driver IC power up/down routine should include a delay period between high voltage and low voltage power sources during turn on/off. It gives the panel enough time to complete the action of charge and discharge before/after the operation.

#### 5.2.1 POWER UP SEQUENCE

1. Power up  $V_{DD}$
2. Send Display off command
3. Initialization
4. Clear Screen
5. Power up  $V_{CC}$
6. Delay 100ms  
(when  $V_{DD}$  is stable)
7. Send Display on command

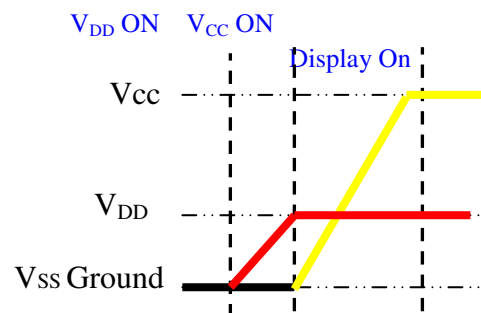

#### 5.2.2 POWER DOWN SEQUENCE

1. Send Display off command
2. Power down  $V_{CC}$
3. Delay 100ms  
(When  $V_{PP}$  reach 0 and panel is completely discharges)
4. Power down  $V_{DD}$

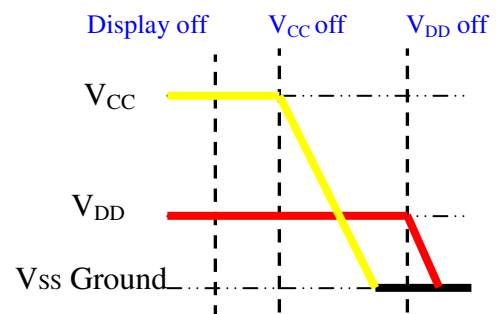

### 5.3 RESET CIRCUIT

When RES# input is low, the chip is initialized with the following status:

1. Display is OFF
2. 128x80 Display mode
3. Normal segment and display data column and row address mapping (SEG0 mapped to column address 00H and COM0 mapped to row address 00H)
4. Shift register data clear in serial interface
5. Display start line is set at display RAM address 0
6. Column address counter is set at 0
7. Normal scan direction of the COM outputs
8. Contrast control register is set at 80H
9. Normal display mode (Equivalent to A4h command)

|             |               |        |
|-------------|---------------|--------|
| Product No. | DD-12864YO-5A | REV. A |
|             |               |        |

|      |         |
|------|---------|
| Page | 16 / 25 |
|------|---------|



## 5.4 ACTUAL APPLICATION EXAMPLE

Command usage and explanation of an actual example

<Initialisation Setting>

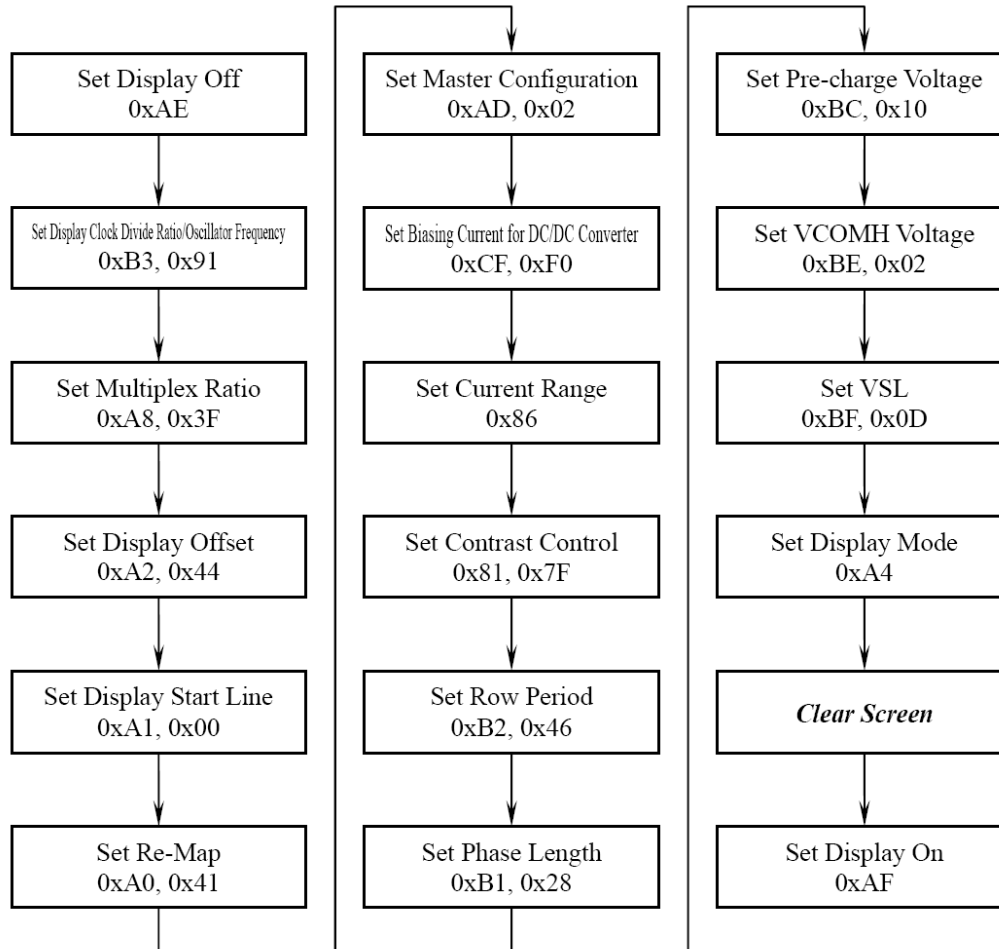

If the noise is accidentally occurred at the displaying window during the operation, please reset the display in order to recover the display function.

|             |               |        |
|-------------|---------------|--------|
| Product No. | DD-12864YO-5A | REV. A |
|             |               |        |

|      |         |
|------|---------|
| Page | 17 / 25 |
|------|---------|

## 6 PACKAGING AND LABELLING SPECIFICATION

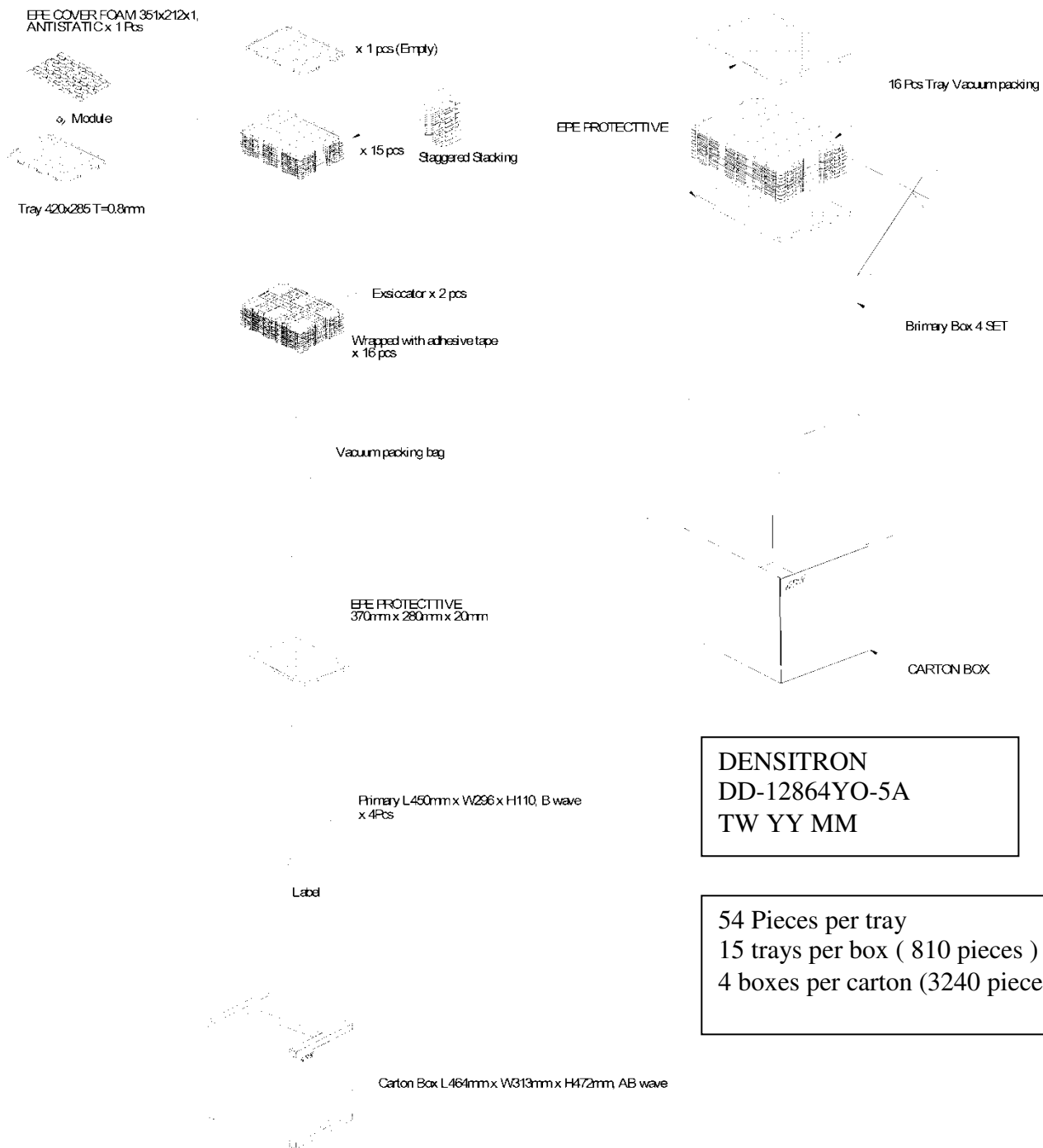

DENSITRON  
DD-12864YO-5A  
TW YY MM

54 Pieces per tray  
15 trays per box ( 810 pieces )  
4 boxes per carton (3240 pieces )

|             |               |        |
|-------------|---------------|--------|
| Product No. | DD-12864YO-5A | REV. A |
|             |               |        |

|      |         |
|------|---------|
| Page | 18 / 25 |
|------|---------|

## 7 QUALITY ASSURANCE SPECIFICATION

### 7.1 CONFORMITY

---

The performance, function and reliability of the shipped products conform to the Product Specification.

### 7.2 DELIVERY ASSURANCE

---

#### 7.2.1 DELIVERY INSPECTION STANDARDS

IPC-AA610, class 2 electronic assemblies standard

#### 7.2.2 Zone definition

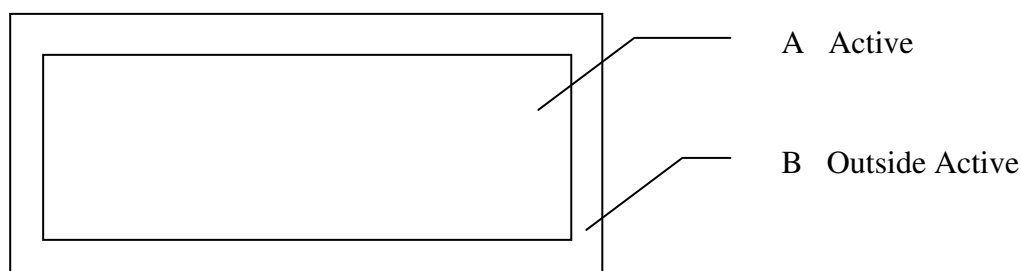

#### 7.2.3 Visual inspection

Test and measurement to be conducted under following conditions :

|   |          |
|---|----------|
| Temperature:  | 23±5°C   |
| Humidity:   | 55±15%RH |
| Fluorescent lamp:                                   | 30 W     |
| Distance between the Panel & Eyes of the Inspector: | ≥30cm    |
| Distance between the Panel & the lamp:              | ≥50cm    |

|             |               |        |
|-------------|---------------|--------|
| Product No. | DD-12864YO-5A | REV. A |
|             |               |        |

|      |         |
|------|---------|
| Page | 19 / 25 |
|------|---------|

### 7.2.4 Standard of appearance inspection

Units: mm

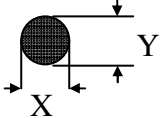
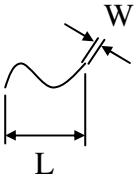
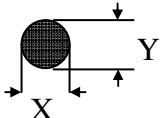
| Class                      | Item                         | Criteria   |                     |  |  |      |        |        |                     |            |            |                           |   |                            |   |                      |   |                     |  |  |  |        |       |        |        |    |               |            |            |           |              |   |           |  |   |
|----------------------------|------------------------------|--|---------------------|--|--|------|--------|--------|---------------------|------------|------------|---------------------------|---|----------------------------|---|----------------------|---|---------------------|--|--|--|--------|-------|--------|--------|----|---------------|------------|------------|-----------|--------------|---|-----------|--|---|
| Minor                      | Packing & Label              | Outside & inside package   Presence of product no., lot no., quantity  |                     |  |  |      |        |        |                     |            |            |                           |   |                            |   |                      |   |                     |  |  |  |        |       |        |        |    |               |            |            |           |              |   |           |  |   |
| Critical                   |                              | Product must not be mixed with others and quantity must not be different from that indicated on the label  |                     |  |  |      |        |        |                     |            |            |                           |   |                            |   |                      |   |                     |  |  |  |        |       |        |        |    |               |            |            |           |              |   |           |  |   |
| Major                      | Dimension                    | Product dimensions must be according to specification and drawing  |                     |  |  |      |        |        |                     |            |            |                           |   |                            |   |                      |   |                     |  |  |  |        |       |        |        |    |               |            |            |           |              |   |           |  |   |
| Major                      | Electrical                   | Product electrical characteristics must be according to specification  |                     |  |  |      |        |        |                     |            |            |                           |   |                            |   |                      |   |                     |  |  |  |        |       |        |        |    |               |            |            |           |              |   |           |  |   |
| Critical                   | OLED Display                 | Missing lines, short circuits or wrong patterns on OLED display are not allowed  |                     |  |  |      |        |        |                     |            |            |                           |   |                            |   |                      |   |                     |  |  |  |        |       |        |        |    |               |            |            |           |              |   |           |  |   |
| Minor                      | Black spot, white spot, dust | <p>Round type: as per following drawing<br/> <math>\varnothing = (X+Y)/2</math></p>  <table border="1" style="margin-left: auto; margin-right: auto;"> <thead> <tr> <th colspan="3">Acceptable quantity</th> </tr> <tr> <th>Size</th> <th>Zone A</th> <th>Zone B</th> </tr> </thead> <tbody> <tr> <td><math>\varnothing &lt; 0.1</math></td> <td>Any number</td> <td rowspan="4">Any number</td> </tr> <tr> <td><math>0.1 &lt; \varnothing &lt; 0.2</math></td> <td>3</td> </tr> <tr> <td><math>0.2 &lt; \varnothing &lt; 0.25</math></td> <td>1</td> </tr> <tr> <td><math>0.25 &lt; \varnothing</math></td> <td>0</td> </tr> </tbody> </table> <p>Line type: as per following drawing</p>  <table border="1" style="margin-left: auto; margin-right: auto;"> <thead> <tr> <th colspan="4">Acceptable quantity</th> </tr> <tr> <th>Length</th> <th>Width</th> <th>Zone A</th> <th>Zone B</th> </tr> </thead> <tbody> <tr> <td>--</td> <td><math>W \leq 0.05</math></td> <td>Any number</td> <td rowspan="3">Any number</td> </tr> <tr> <td><math>L &lt; 2.0</math></td> <td><math>W \leq 0.1</math></td> <td>3</td> </tr> <tr> <td><math>L &gt; 2.0</math></td> <td></td> <td>0</td> </tr> </tbody> </table> <p style="text-align: center;">Total acceptable quantity: 3</p> | Acceptable quantity |  |  | Size | Zone A | Zone B | $\varnothing < 0.1$ | Any number | Any number | $0.1 < \varnothing < 0.2$ | 3 | $0.2 < \varnothing < 0.25$ | 1 | $0.25 < \varnothing$ | 0 | Acceptable quantity |  |  |  | Length | Width | Zone A | Zone B | -- | $W \leq 0.05$ | Any number | Any number | $L < 2.0$ | $W \leq 0.1$ | 3 | $L > 2.0$ |  | 0 |
| Acceptable quantity        |                              |  |                     |  |  |      |        |        |                     |            |            |                           |   |                            |   |                      |   |                     |  |  |  |        |       |        |        |    |               |            |            |           |              |   |           |  |   |
| Size                       | Zone A                       | Zone B   |                     |  |  |      |        |        |                     |            |            |                           |   |                            |   |                      |   |                     |  |  |  |        |       |        |        |    |               |            |            |           |              |   |           |  |   |
| $\varnothing < 0.1$        | Any number                   | Any number   |                     |  |  |      |        |        |                     |            |            |                           |   |                            |   |                      |   |                     |  |  |  |        |       |        |        |    |               |            |            |           |              |   |           |  |   |
| $0.1 < \varnothing < 0.2$  | 3                            |  |                     |  |  |      |        |        |                     |            |            |                           |   |                            |   |                      |   |                     |  |  |  |        |       |        |        |    |               |            |            |           |              |   |           |  |   |
| $0.2 < \varnothing < 0.25$ | 1                            |  |                     |  |  |      |        |        |                     |            |            |                           |   |                            |   |                      |   |                     |  |  |  |        |       |        |        |    |               |            |            |           |              |   |           |  |   |
| $0.25 < \varnothing$       | 0                            |  |                     |  |  |      |        |        |                     |            |            |                           |   |                            |   |                      |   |                     |  |  |  |        |       |        |        |    |               |            |            |           |              |   |           |  |   |
| Acceptable quantity        |                              |  |                     |  |  |      |        |        |                     |            |            |                           |   |                            |   |                      |   |                     |  |  |  |        |       |        |        |    |               |            |            |           |              |   |           |  |   |
| Length                     | Width                        | Zone A   | Zone B              |  |  |      |        |        |                     |            |            |                           |   |                            |   |                      |   |                     |  |  |  |        |       |        |        |    |               |            |            |           |              |   |           |  |   |
| --                         | $W \leq 0.05$                | Any number   | Any number          |  |  |      |        |        |                     |            |            |                           |   |                            |   |                      |   |                     |  |  |  |        |       |        |        |    |               |            |            |           |              |   |           |  |   |
| $L < 2.0$                  | $W \leq 0.1$                 | 3  |                     |  |  |      |        |        |                     |            |            |                           |   |                            |   |                      |   |                     |  |  |  |        |       |        |        |    |               |            |            |           |              |   |           |  |   |
| $L > 2.0$                  |                              | 0  |                     |  |  |      |        |        |                     |            |            |                           |   |                            |   |                      |   |                     |  |  |  |        |       |        |        |    |               |            |            |           |              |   |           |  |   |
| Minor                      | Polariser scratch            | Scratch on protective film is permitted<br>Scratch on polariser: same as No. 1   |                     |  |  |      |        |        |                     |            |            |                           |   |                            |   |                      |   |                     |  |  |  |        |       |        |        |    |               |            |            |           |              |   |           |  |   |
| Minor                      | Polariser bubble             | <p><math>\varnothing = (X+Y)/2</math></p>  <table border="1" style="margin-left: auto; margin-right: auto;"> <thead> <tr> <th colspan="3">Acceptable quantity</th> </tr> <tr> <th>Size</th> <th>Zone A</th> <th>Zone B</th> </tr> </thead> <tbody> <tr> <td><math>\varnothing &lt; 0.5</math></td> <td>Any number</td> <td rowspan="2">Any number</td> </tr> <tr> <td><math>\varnothing &gt; 0.5</math></td> <td>0</td> </tr> </tbody> </table>   | Acceptable quantity |  |  | Size | Zone A | Zone B | $\varnothing < 0.5$ | Any number | Any number | $\varnothing > 0.5$       | 0 |                            |   |                      |   |                     |  |  |  |        |       |        |        |    |               |            |            |           |              |   |           |  |   |
| Acceptable quantity        |                              |  |                     |  |  |      |        |        |                     |            |            |                           |   |                            |   |                      |   |                     |  |  |  |        |       |        |        |    |               |            |            |           |              |   |           |  |   |
| Size                       | Zone A                       | Zone B   |                     |  |  |      |        |        |                     |            |            |                           |   |                            |   |                      |   |                     |  |  |  |        |       |        |        |    |               |            |            |           |              |   |           |  |   |
| $\varnothing < 0.5$        | Any number                   | Any number   |                     |  |  |      |        |        |                     |            |            |                           |   |                            |   |                      |   |                     |  |  |  |        |       |        |        |    |               |            |            |           |              |   |           |  |   |
| $\varnothing > 0.5$        | 0                            |  |                     |  |  |      |        |        |                     |            |            |                           |   |                            |   |                      |   |                     |  |  |  |        |       |        |        |    |               |            |            |           |              |   |           |  |   |

|             |               |        |
|-------------|---------------|--------|
| Product No. | DD-12864YO-5A | REV. A |
|             |               |        |

|      |         |
|------|---------|
| Page | 20 / 25 |
|------|---------|

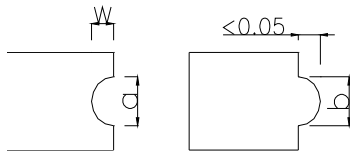
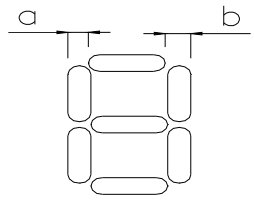
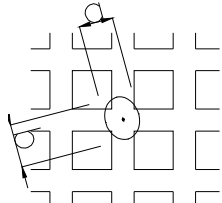
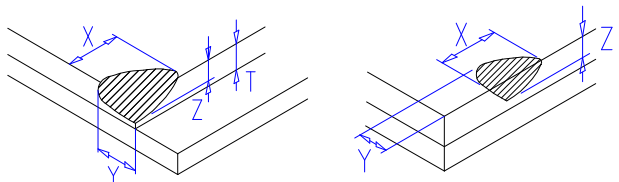
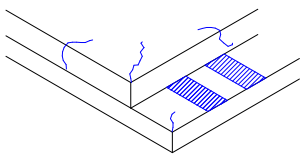
| Class                        | Item                         | Criteria   |                     |  |      |  |              |            |                   |            |                           |   |            |  |            |                |         |             |                     |  |      |  |                        |            |                              |   |                              |   |                              |   |
|------------------------------|------------------------------|--|---------------------|--|------|--|--------------|------------|-------------------|------------|---------------------------|---|------------|--|------------|----------------|---------|-------------|---------------------|--|------|--|------------------------|------------|------------------------------|---|------------------------------|---|------------------------------|---|
| Minor                        | Segment deformation          | <p>1b. Pin hole on dot matrix display</p>  <table border="1" data-bbox="1005 336 1404 526"> <thead> <tr> <th colspan="2">Acceptable quantity</th> </tr> <tr> <th>Size</th> <th></th> </tr> </thead> <tbody> <tr> <td><math>a, b &lt; 0.1</math></td> <td>Any number</td> </tr> <tr> <td><math>(a+b)/2 \le 0.1</math></td> <td>Any number</td> </tr> <tr> <td><math>0.5 &lt; \varnothing &lt; 1.0</math></td> <td>3</td> </tr> </tbody> </table> <p>Total acceptable quantity: 7</p> <p>2. Segments / dots with different width</p>  <table border="1" data-bbox="1005 728 1404 840"> <thead> <tr> <th colspan="2">Acceptable</th> </tr> </thead> <tbody> <tr> <td><math>a \geq b</math></td> <td><math>a/b \leq 4/3</math></td> </tr> <tr> <td><math>a &lt; b</math></td> <td><math>a/b &gt; 4/3</math></td> </tr> </tbody> </table> <p>3. Alignment layer defect</p> <p><math>\varnothing = (a+b)/2</math></p>  <table border="1" data-bbox="1005 907 1404 1131"> <thead> <tr> <th colspan="2">Acceptable quantity</th> </tr> <tr> <th>Size</th> <th></th> </tr> </thead> <tbody> <tr> <td><math>\varnothing \leq 0.4</math></td> <td>Any number</td> </tr> <tr> <td><math>0.4 &lt; \varnothing \leq 1.0</math></td> <td>5</td> </tr> <tr> <td><math>1.0 &lt; \varnothing \leq 1.5</math></td> <td>3</td> </tr> <tr> <td><math>1.5 &lt; \varnothing \leq 2.0</math></td> <td>2</td> </tr> </tbody> </table> <p>Total acceptable quantity: 7</p> | Acceptable quantity |  | Size |  | $a, b < 0.1$ | Any number | $(a+b)/2 \le 0.1$ | Any number | $0.5 < \varnothing < 1.0$ | 3 | Acceptable |  | $a \geq b$ | $a/b \leq 4/3$ | $a < b$ | $a/b > 4/3$ | Acceptable quantity |  | Size |  | $\varnothing \leq 0.4$ | Any number | $0.4 < \varnothing \leq 1.0$ | 5 | $1.0 < \varnothing \leq 1.5$ | 3 | $1.5 < \varnothing \leq 2.0$ | 2 |
| Acceptable quantity          |                              |  |                     |  |      |  |              |            |                   |            |                           |   |            |  |            |                |         |             |                     |  |      |  |                        |            |                              |   |                              |   |                              |   |
| Size                         |                              |  |                     |  |      |  |              |            |                   |            |                           |   |            |  |            |                |         |             |                     |  |      |  |                        |            |                              |   |                              |   |                              |   |
| $a, b < 0.1$                 | Any number                   |  |                     |  |      |  |              |            |                   |            |                           |   |            |  |            |                |         |             |                     |  |      |  |                        |            |                              |   |                              |   |                              |   |
| $(a+b)/2 \le 0.1$            | Any number                   |  |                     |  |      |  |              |            |                   |            |                           |   |            |  |            |                |         |             |                     |  |      |  |                        |            |                              |   |                              |   |                              |   |
| $0.5 < \varnothing < 1.0$    | 3                            |  |                     |  |      |  |              |            |                   |            |                           |   |            |  |            |                |         |             |                     |  |      |  |                        |            |                              |   |                              |   |                              |   |
| Acceptable                   |                              |  |                     |  |      |  |              |            |                   |            |                           |   |            |  |            |                |         |             |                     |  |      |  |                        |            |                              |   |                              |   |                              |   |
| $a \geq b$                   | $a/b \leq 4/3$               |  |                     |  |      |  |              |            |                   |            |                           |   |            |  |            |                |         |             |                     |  |      |  |                        |            |                              |   |                              |   |                              |   |
| $a < b$                      | $a/b > 4/3$                  |  |                     |  |      |  |              |            |                   |            |                           |   |            |  |            |                |         |             |                     |  |      |  |                        |            |                              |   |                              |   |                              |   |
| Acceptable quantity          |                              |  |                     |  |      |  |              |            |                   |            |                           |   |            |  |            |                |         |             |                     |  |      |  |                        |            |                              |   |                              |   |                              |   |
| Size                         |                              |  |                     |  |      |  |              |            |                   |            |                           |   |            |  |            |                |         |             |                     |  |      |  |                        |            |                              |   |                              |   |                              |   |
| $\varnothing \leq 0.4$       | Any number                   |  |                     |  |      |  |              |            |                   |            |                           |   |            |  |            |                |         |             |                     |  |      |  |                        |            |                              |   |                              |   |                              |   |
| $0.4 < \varnothing \leq 1.0$ | 5                            |  |                     |  |      |  |              |            |                   |            |                           |   |            |  |            |                |         |             |                     |  |      |  |                        |            |                              |   |                              |   |                              |   |
| $1.0 < \varnothing \leq 1.5$ | 3                            |  |                     |  |      |  |              |            |                   |            |                           |   |            |  |            |                |         |             |                     |  |      |  |                        |            |                              |   |                              |   |                              |   |
| $1.5 < \varnothing \leq 2.0$ | 2                            |  |                     |  |      |  |              |            |                   |            |                           |   |            |  |            |                |         |             |                     |  |      |  |                        |            |                              |   |                              |   |                              |   |
| Minor                        | Panel Chipping               | <p><math>X \leq 1/6</math> Panel length<br/><math>Y \leq 1</math><br/><math>Z \leq T</math></p>    |                     |  |      |  |              |            |                   |            |                           |   |            |  |            |                |         |             |                     |  |      |  |                        |            |                              |   |                              |   |                              |   |
| Minor                        | Panel Cracking               | <p>Cracks not allowed</p>    |                     |  |      |  |              |            |                   |            |                           |   |            |  |            |                |         |             |                     |  |      |  |                        |            |                              |   |                              |   |                              |   |
| Minor                        | Copper exposed (pin or film) | Not allowed if visible by eye inspection   |                     |  |      |  |              |            |                   |            |                           |   |            |  |            |                |         |             |                     |  |      |  |                        |            |                              |   |                              |   |                              |   |
| Minor                        | Film or Trace Damage         | Not allowed if affect electrical function  |                     |  |      |  |              |            |                   |            |                           |   |            |  |            |                |         |             |                     |  |      |  |                        |            |                              |   |                              |   |                              |   |

|             |               |        |
|-------------|---------------|--------|
| Product No. | DD-12864YO-5A | REV. A |
|             |               |        |

|      |         |
|------|---------|
| Page | 21 / 25 |
|------|---------|

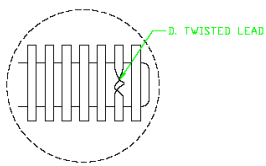
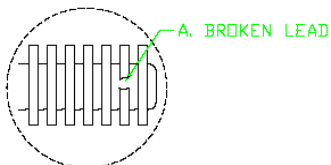
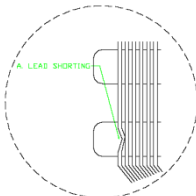
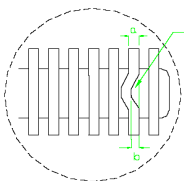
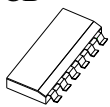
| Class    | Item  | Criteria  |                         |            |
|----------|---|---|-------------------------|------------|
| Minor    | Contact Lead Twist  | Not allowed<br>   |                         |            |
| Minor    | Contact Lead Broken   | Not allowed<br>   |                         |            |
| Minor    | Contact Lead Bent   | Not allowed if bent lead causes short circuit<br>                             |                         |            |
|          |   | Not allowed if bent lead extends horizontally more than 50% of its width<br> |                         |            |
| Minor    | Colour uniformity   | Level of sample for approval set as limit sample  |                         |            |
| Major    |  | No unmelted solder paste should be present on PCB   |                         |            |
| Critical |   | Cold solder joints, missing solder connections, or oxidation are not allowed  |                         |            |
| Minor    |   | No residue or solder balls on PCB are allowed   |                         |            |
| Critical |   | Short circuits on components are not allowed  |                         |            |
| Minor    | Tray particles  |   | Size                    | Quantity   |
|          |   | On tray   | $\varnothing < 0.2$     | Any number |
|          |   |   | $\varnothing > 0.25$    | 4          |
|          |   | On display  | $\varnothing \geq 0.25$ | 2          |
| L = 3    | 1   |   |                         |            |

|             |               |        |
|-------------|---------------|--------|
| Product No. | DD-12864YO-5A | REV. A |
|             |               |        |

|      |         |
|------|---------|
| Page | 22 / 25 |
|------|---------|

## **7.3 DEALING WITH CUSTOMER COMPLAINTS**

---

### **7.3.1 Non-conforming analysis**

Purchaser should supply Densitron with detailed data of non-conforming sample.  
 After accepting it, Densitron should complete the analysis in two weeks from receiving the sample.  
 If the analysis cannot be completed on time, Densitron must inform the purchaser.

### **7.3.2 Handling of non-conforming displays**

If any non-conforming displays are found during customer acceptance inspection which Densitron is clearly responsible for, return them to Densitron.  
 Both Densitron and customer should analyse the reason and discuss the handling of non-conforming displays when the reason is not clear.  
 Equally, both sides should discuss and come to agreement for issues pertaining to modification of Densitron quality assurance standard.

|             |               |        |
|-------------|---------------|--------|
| Product No. | DD-12864YO-5A | REV. A |
|             |               |        |

|      |         |
|------|---------|
| Page | 23 / 25 |
|------|---------|

## 8 RELIABILITY SPECIFICATION

### 8.1 RELIABILITY TESTS

| Test Item   | Test Condition   | Evaluation and assessment                   |
|---|--|---|
| High Temperature Operation                          | 70°C, 240 hours  | No abnormalities in function and appearance |
| Low Temperature Operation                           | -30°C, 240 hours   | No abnormalities in function and appearance |
| High Temperature Storage                            | 80°C, 240 hours  | No abnormalities in function and appearance |
| Low Temperature Storage                             | -40°C, 240 hours   | No abnormalities in function and appearance |
| High Temperature & High Humidity Storage(Operation) | 60°C, 90%RH, 240 hours                                     | No abnormalities in function and appearance |
| Thermal Shock                                       | 24 cycle of<br>-40°C 1 Hour,<br>85°C 1 Hour. 60 Mins dwell | No abnormalities in function and appearance |

- The samples used for above tests do not include polarizer.
- No moisture condensation is observed during tests.

#### 8.1.1 FAILURE CHECK STANDARD

After the completion of the described reliability test, the samples were left at room temperature for 2 hrs prior to conducting the failure test at 23±5 °C; 55±15% RH

### 8.2 LIFE TIME

| Item | Description  |
|------|--|
| 1    | Function, performance, appearance, etc. shall be free from remarkable deterioration more than 40,000 hours under 100 cd/m <sup>2</sup> brightness and 50% Checkerboard, humidity (50% RH), and in area not exposed to direct sunlight. |
| 2    | End of lifetime is specified as 50% of initial brightness.   |

|             |               |        |
|-------------|---------------|--------|
| Product No. | DD-12864YO-5A | REV. A |
|             |               |        |

|      |         |
|------|---------|
| Page | 24 / 25 |
|------|---------|



## 9 HANDLING PRECAUTIONS

### *Safety*

If the panel breaks, be careful not to get the organic substance in your mouth or in your eyes.

If the organic substance touches your skin or clothes, wash it off immediately using soap and plenty of water.

### *Mounting and Design*

Place a transparent plate (e.g. acrylic, polycarbonate or glass) on the display surface to protect the display from external pressure. Leave a small gap between the transparent plate and the display surface.

Design the system so that no input signal is given unless the power supply voltage is applied.

### *Caution during OLED cleaning*

Lightly wipe the display surface with a soft cloth soaked with Isopropyl alcohol, Ethyl alcohol or Trichlorotrifluoroethane.

Do not wipe the display surface with dry or hard materials that will damage the polariser surface.

Do not use aromatic solvents (toluene and xylene), or ketonic solvents (ketone and acetone).

### *Caution against static charge*

As the display uses C-MOS LSI drivers, connect any unused input terminal to  $V_{DD}$  or  $V_{SS}$ . Do not input any signals before power is turned on.

Also, ground your body, work/assembly table and assembly equipment to protect against static electricity.

### *Packaging*

Displays use OLED elements, and must be treated as such. Avoid strong shock and drop from a height.

To prevent displays from degradation, do not operate or store them exposed directly to sunshine or high temperature/humidity.

### *Caution during operation*

It is indispensable to drive the display within the specified voltage limit since excessive voltage shortens its life.

### *Other Precautions*

When a display module is operated for a long of time with fixed pattern may remain as an after image or slight contrast deviation may occur.

Nonetheless, if the operation is interrupted and left unused for a while, normal state can be restored.

Also, there will be no problem in the reliability of the module.

### *Storage*

Store the display in a dark place where the temperature is  $25^{\circ}\text{C} \pm 10^{\circ}\text{C}$  and the humidity below 50%RH.

Store the display in a clean environment, free from dust, organic solvents and corrosive gases.

Do not crash, shake or jolt the display (including accessories).

|             |               |        |
|-------------|---------------|--------|
| Product No. | DD-12864YO-5A | REV. A |
|             |               |        |

|      |         |
|------|---------|
| Page | 25 / 25 |
|------|---------|

## **X-ON Electronics**

Largest Supplier of Electrical and Electronic Components

*Click to view similar products for [densitron](#) manufacturer:*

Other Similar products are found below :

[DMT024QVNUNT0-2C](#) [DMT028QVNTNT0S-1A](#) [DMT028QVHXCMI-1A](#) [DMT024QVNUCMI-2A](#) [LMR4048BG2C16HNG/5V](#)