

**RoHS Compliant
Pb - Lead Free**

Ltr	Revisions	Date	Appr

Electrical Specifications:

Nominal Frequency	18.432	MHz
Mode of Oscillation	Fundamental	-
Frequency Tolerance at 25°C	±30	PPM Max
Frequency Stability over Temperature Range	±50	
Operating Temperature Range (Extended)	-40 to +85	° C
Storage Temperature Range	-55 to +125	
Aging per Year	±3	PPM Max
Load Capacitance	18	pF
Shunt Capacitance (Maximum)	7	
Equivalent Series Resistance (ESR)	40	Ohms Max
Drive Level	100 Typ - 500 Max	uW
Solder Reflow Characteristics	+260 for 10 s Max	° C

Mechanical Specifications:

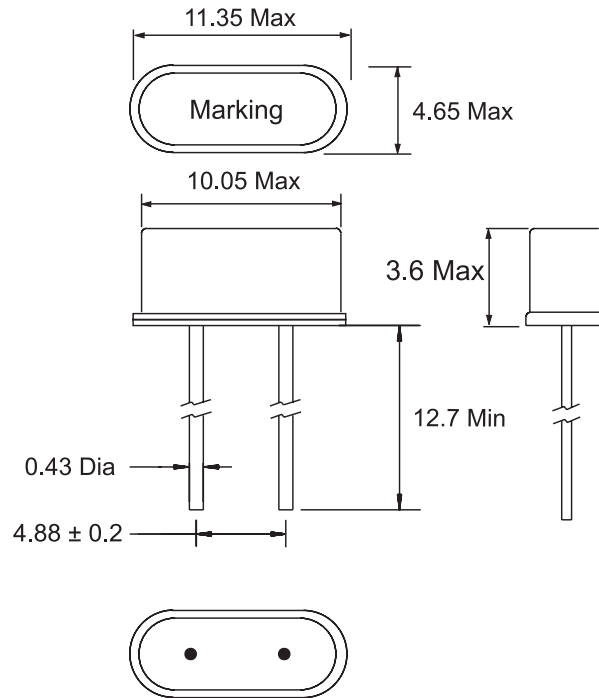

11-3 Chien-Kuo Rd T.E.P.Z. 4027 Taiwan, ROC

All dimensions are millimeters.

CAD: TR

Review: SL

Appr: AL

Page: 1/1 | Date: Jan. 16, 2008

Specification Title:

**Quartz Crystal Unit
HC-49/U-S - Through Hole
Product Specification
Farnell Order Code: 1538748**

Part Number: **CA-18.432-18-3050-X**

X-ON Electronics

Largest Supplier of Electrical and Electronic Components

Click to view similar products for [aker manufacturer](#):

Other Similar products are found below :

[SMA-027000-3BL4TD](#) [CXA-012000-3F4D40](#) [CXA-016384-3D4X20](#) [CXA-026000-3F7F20](#) [C-3.579545-18-3050-X](#) [SMF-020000-5BC6T0](#)
[SMA-040000-5CL4T5](#) [CXAN-025000-3F12D40](#) [C-8.000-18-3050-X](#) [CXAN-040000-3F15D41](#) [SMBN-033333-7BL4T00](#) [CXA-026000-3FCF20](#) [CA-18.432-18-3050-X](#) [C-4.194304-18-3050-X](#) [CXA-039000-7F1X40](#) [S33305-50.000-X](#) [C3E-14.31818-12-3030-X](#) [S53305-50.000-X](#) [S73305-10.000-X-15](#) [C6S-18.432-12-3030-X](#) [C7S-8.000-12-50100-X1](#) [C-24.576-18-3050-X](#) [C3E-14.7456-12-3030-X](#) [C7S-6.000-12-50100-X1](#) [CAA-4.194304-18-3050-X](#) [C3E-14.7456-12-50100-X1](#) [C6S-16.000-12-3030-X](#) [S73305T-24.000-X-15-R](#) [CA-8.000-18-3050-X](#) [C3E-16.000-12-50100-X1](#) [S73305-12.000-X-15](#) [49S-008000-FDRD10](#) [S73305-14.7456-X-15](#) [C3E-18.432-12-3030-X](#) [C3E-20.000-12-50100-X1](#) [CAA-3.579545-18-3050-X](#) [C7S-20.000-12-3030-X](#) [C6S-24.000-12-3030-X](#) [CA-25.000-18-3050-X](#) [CAA-16.000-18-3050-X](#) [49SN-011059-FX16X10](#) [C7S-24.000-12-50100-X1](#) [CA4-8.000-18-3050-X](#) [C3E-12.000-12-3030-X](#) [C5S-20.000-12-3030-X](#) [S7A33025-156.250-L-X-R](#) [S7A33025-100.000-L-X-R](#) [S3A25025-125.000-L-X-R](#) [S3A25025-100.000-L-X-R](#) [S3A25025-50.000-L-X-R](#)