

6A Monolithic Synchronous DC/DC Step-Down Converter with Digital Power System Management

FEATURES

- 2.25V to 5.5V Input Voltage Range
- ±1% Total Output Voltage Accuracy Over Temperature at $V_{IN} = 3.3V$ or 5V
- Single Resistor-Programmable Output Voltage
- PMBus Compliant Serial Interface:
 - Programmable Output Voltage Margining: Up to ±25% V_{OUT} Range with 0.1% Resolution
 - Read back of Average and Peak Temperature, Current, and Voltage (25Hz Refresh Rate)
 - Fault Status
- Phase-Lockable Fixed Frequency Up to 3MHz
- Less Than 1ms Power-Up Time
- Integrated 13-Bit ADC
- Optional External Reference Input
- Pin Selectable Fast-Margining of the Output Voltage
- Power Good Flag with Pin Programmable Thresholds and Filter Delay
- Differential Remote Output Voltage Sensing
- Master Shutdown Mode: $1\mu A$ Supply Current
- Clock Out for 2-Phase Operation (12A Output Current)
- Available in a Thermally-Enhanced 38-Lead 4mm × 6mm QFN Package

APPLICATIONS

- Intelligent Energy Efficient Power Conversion
- ASIC/FPGA/Processor Power
- Distributed Power Systems
- Point of Load Power Conversion

DESCRIPTION

The **LTC®3815** is a high efficiency, 6A monolithic synchronous buck regulator using a phase lockable controlled on-time, current mode architecture. The output voltage is programmable from 0.4V to 72% of V_{IN} with a single external resistor or an external voltage reference through the reference input (REF) pin. The output voltage can be margined up or down up to ±25% with 0.1% resolution via a PMBus-compliant serial interface. The serial interface can also be used to read back fault status and both time-averaged (~4ms) and peak input/output current, input/output voltage and temperature. System configuration and monitoring is supported by the **LTPowerPlay™** development system.

The architecture provides extremely fast transient response and allows operation at the very low on-times required to regulate low output voltages at high switching frequencies. The operating frequency is programmable from 400kHz to 3MHz with an external resistor or for noise sensitive applications, it can be synchronized to an external clock over the same range. The operating supply voltage range is from 2.25V to 5.5V making it suitable for operation from 2.5V, 3.3V or 5V rails or Lithium-Ion batteries.

LT, LT, LTC, LTM, Linear Technology and the Linear logo are registered trademarks and Hot Swap and LTPowerPlay are trademarks of Linear Technology Corporation. All other trademarks are the property of their respective owners. Protected by U.S. Patents including 5481178, 5705919, 5929620, 6144194, 6177787, 6580258, 5408150, 7420359. Licensed under U.S. Patent 7000125 and other related patents worldwide.

TYPICAL APPLICATION

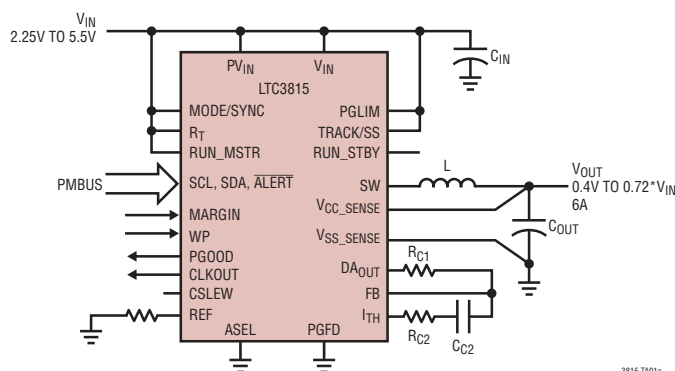

Efficiency and Power Loss vs Load Current

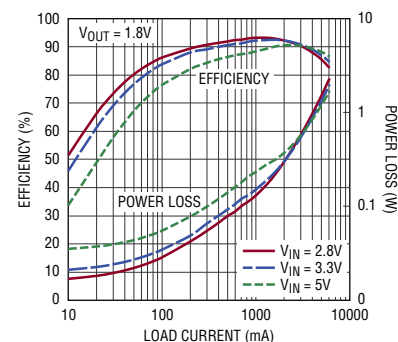

LTC3815

ABSOLUTE MAXIMUM RATINGS

(Notes 1, 7)

V_{IN} , P_{VIN}	-0.3V to 6V
V_{CC_SENSE} , V_{SS_SENSE} , C_{SLEW} , R_T , I_{TH} , MODE/SYNC, REF, TRACK/SS, PGFD, PGLIM, ASEL, DA_{OUT} , MARGIN, RUN_STBY, FB.....	-0.3V to ($V_{IN} + 0.3V$)
RUN_MSTR, PGOOD, \overline{ALERT} , SCL, SDA Voltage.....	-0.3V to 6V
WP.....	-0.3V to 2.5V
Operating Junction Temperature Range (Notes 2, 3).....	-40°C to 125°C
Storage Temperature Range.....	-65°C to 125°C

PIN CONFIGURATION

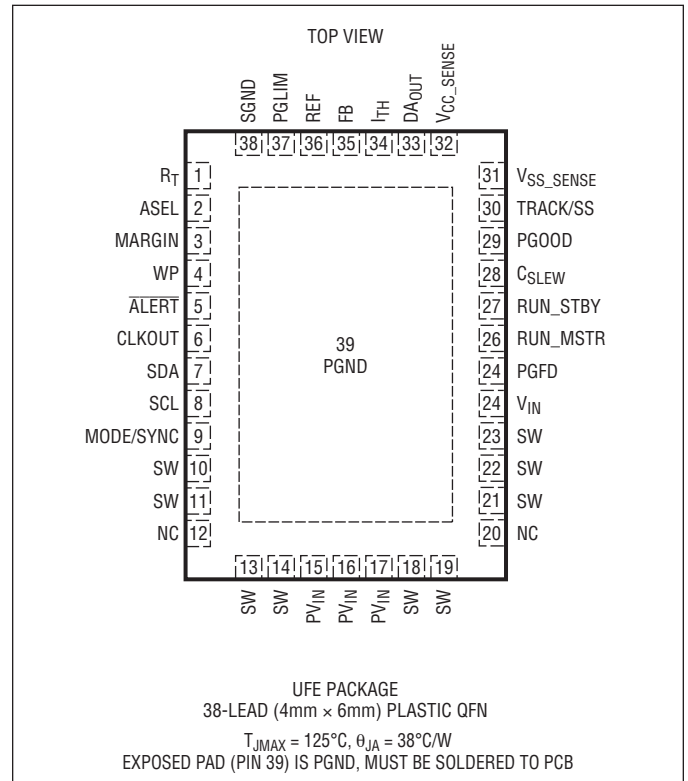

ORDER INFORMATION

LEAD FREE FINISH	TAPE AND REEL	PART MARKING*	PACKAGE DESCRIPTION	TEMPERATURE RANGE
LTC3815EUFE#PBF	LTC3815EUFE#TRPBF	3815	38-Lead (4mm × 6mm) Plastic QFN	-40°C to 125°C
LTC3815IUFE#PBF	LTC3815IUFE#TRPBF	3815	38-Lead (4mm × 6mm) Plastic QFN	-40°C to 125°C

Consult LTC Marketing for parts specified with wider operating temperature ranges. *The temperature grade is identified by a label on the shipping container.

For more information on lead free part marking, go to: <http://www.linear.com/leadfree/>

For more information on tape and reel specifications, go to: <http://www.linear.com/tapeandreeel/>

ELECTRICAL CHARACTERISTICS

The ● denotes the specifications which apply over the specified operating junction temperature range, $V_{IN} = 3.3V$ unless otherwise noted. (Note 2)

SYMBOL	PARAMETER	CONDITIONS		MIN	TYP	MAX	UNITS
V_{IN}	Input Supply Range		●	2.25		5.5	V
V_{OUT}	Output Voltage Programming Range		●	0.4		72% of V_{IN}	V
I_Q	V_{IN} Supply Current Normal Mode Standby Shutdown	$V_{RUN_MSTR} > 1V$ (Note 4) $V_{RUN_STBY} = 0V$, $V_{RUN_MSIR} > 1V$ $V_{RUN_MSTR} = 0V$, $V_{SDA} = V_{SCL} \geq V_{IN}$			5 120 1	8 200	mA μA μA
V_{UVLO}	V_{IN} Undervoltage Reset Hysteresis	V_{IN} Rising V_{IN} Falling		2.05	2.15 0.2	2.25	V V
I_{REF}	Reference Current	(Note 10)	●	99.2 99.5	100 100	100.8 100.5	μA μA
$\Delta I_{REF,LINE}$	Reference Current Line Regulation	$V_{IN} = 2.5V$ to $5.5V$ (Note 10)	●		0.05	0.2	%/V
$\Delta V_{OUT,OFFSET}$	Regulation Accuracy $\Delta V_{OUT,OFFSET} = (V_{CC_SEN} - V_{SS_SEN}) - V_{REF}$	$V_{REF} = 1.5V$ (Notes 5, 10)	●	-0.5		0.5	%
$\Delta V_{OUT,MARGIN}$	Maximum Margining Range Set Point Accuracy Resolution LSD Step Size	MFR_VOUT_COMMAND = -25% to 25%, $V_{REF} = 1.5V$ (Note 5)	●	-25 -0.5		25 0.5	% % Bits %
NL_VOUT	DAC Nonlinearity					± 1	LSB
A_{EA}	Error Amplifier Open Loop Gain	$I_{TH} = 1V$ (Note 5)			80		dB
f_{BW}	Error Amp Gain Bandwidth Product	(Note 6)			20		MHz
R_{IN}	Differential Amplifier Input Resistance	Measured at V_{CC_SEN} Pin			160		k Ω
t_{SS}	Internal Soft-Start Time/ V_{REF}	External $C_{SS} = \text{Float}$			1		ms/V
I_{CSLEW}	C_{SLEW} Pull-Up Current	$V_{CSLEW} = 0V$			-10		μA
I_{LIM}	SW Valley Current Limit	Sourcing (Note 8) Sinking	●	5.5	6.5 -6	7.5	A A
I_{RUN_STBY}	Regulator On Source Current	$V_{RUN_STBY} = 0V$			-2.5		μA
V_{RUN_MSTR}	Regulator On Threshold (Master Shutdown) Regulator On Hysteresis Regulator Power-Down Threshold	Rising Edge Falling Edge $I_Q < 10\mu A$		0.9	1 0.1 0.65	1.1	V V V
V_{RUN_STBY}	Regulator On Threshold (Standby Mode)			0.7	1	1.2	V
I_{ASEL}	ASEL Programming Current				10		μA
I_{PGFD}	PGFD Programming Current				10		μA
I_{SS}	SS Current	$V_{SS} = 0V$		4	5	6	μA
$V_{IH,MARGIN}$ $V_{IL,MARGIN}$	MARGIN High Voltage MARGIN Low Voltage			1.2		0.4	V V
I_{WP}	WP Pin Pull-Up Current	WP = 0V			10		μA
SR_{MARGIN}	Reference Slew Rate During Margin Change	$C_{SLEW} = 1nF$ $C_{SLEW} = \text{OPEN}$ $C_{SLEW} = SV_{IN}$			0.1 23 10		%/ms %/ms %/ μs
t_{INIT}	Initialization Time	Delay from Power Applied Until V_{OUT} Ramp Up			1	2	ms

Oscillator and Power Switch

f_{OSC}	Oscillator Frequency	$R_T = 25.5k$ $R_T = SV_{IN}$	●	0.85 0.85	1.0 1.0	1.15 1.15	MHz MHz
V_{SYNC}	SYNC Level High SYNC Level Low			1.2		0.3	V V

ELECTRICAL CHARACTERISTICS

The ● denotes the specifications which apply over the specified operating junction temperature range, $V_{IN} = 3.3V$ unless otherwise noted. (Note 2)

SYMBOL	PARAMETER	CONDITIONS	MIN	TYP	MAX	UNITS
V_{MODE}	Discontinuous Mode Threshold			1		V
$t_{ON(MIN)}$	Minimum On-Time			75		ns
$t_{OFF(MIN)}$	Minimum Off-Time			100		ns
R_{TOP}	Top Power PMOS On Resistance			35		m Ω
R_{BOTTOM}	Bottom Power NMOS On Resistance			20		m Ω
θ_{CLKOUT}	Relative Phase of CLKOUT	MODE/SYNC = 0V		180		Deg

PGOOD

$V_{PGOOD,DEFAULT}$	Default PGOOD Threshold	$V_{PGLIM} = V_{IN}, V_{OUT} > 1V$	± 8	± 10	± 12	%
$V_{PGOOD,PROGRAM}$	Program PGOOD Threshold	$V_{PGLIM}/V_{REF} = 0.19, V_{OUT} \geq 1V$ $V_{PGLIM}/V_{REF} = 0.38$	± 6 ± 13	± 10 ± 30	± 9 ± 17	% %
I_{LEAK}	PGOOD Leakage Current				± 5	μA
V_{OL}	PGOOD Output Low Voltage	$I_{OUT} = 3mA$		0.1	0.3	V
t_{PGFD}	PGOOD Filter Delay	PGFD = 0V PGFD = 0.65V PGFD = V_{IN}	150 1.0 17	190 1.6 24	250 2.2 32.5	μs ms ms

Output Voltage Readback

N	Resolution LSB Step Size			13 0.5		Bits mV
$V_{F/S}$	Full Scale Output Voltage	(Note 9)		16.4		V
V_{OUT_TUE}	Total Unadjusted Error		●		± 0.75 ± 0.5	% %
$t_{CONVERT}$	Conversion Time			40		ms

Input Voltage Readback

N	Resolution LSB Step Size			13 4		Bits mV
$V_{F/S}$	Full Scale Input Voltage	(Note 9)		131		V
V_{IN_TUE}	Total Unadjusted Error		●		± 1	%
$t_{CONVERT}$	Conversion Time			40		ms

Output Current Readback

N	Resolution LSB Step Size			13 10		Bits mA
$V_{F/S}$	Full Scale Output Current			± 82		A
I_{OUT_TUE}	Total Unadjusted Error				± 3	%
$t_{CONVERT}$	Conversion Time			40		ms

Input Current Readback

N	Resolution LSB Step Size			13 10		Bits mA
$V_{F/S}$	Full Scale Input Current			± 82		A
I_{IN_TUE}	Total Unadjusted Error				± 3	%
$t_{CONVERT}$	Conversion Time			40		ms

ELECTRICAL CHARACTERISTICS

The ● denotes the specifications which apply over the specified operating junction temperature range, $V_{IN} = 3.3V$ unless otherwise noted. (Note 2)

SYMBOL	PARAMETER	CONDITIONS	MIN	TYP	MAX	UNITS
Temperature Readback						
N	Resolution LSB Step Size			9 1		Bits °C
$V_{F/S}$	Full Scale Temperature			±256		°C
T_{TUE}	Total Unadjusted Error			±3		°C
$t_{CONVERT}$	Conversion Time			40		ms
PMBus Interface Parameters						
$V_{IH, SDA, SCL}$	Input High Voltage		2.1			V
$V_{IL, SDA, SCL}$	Input Low Voltage				0.8	V
$I_{IH, SDA, SCL}$	Input Leakage Current	$0V \leq V_{PIN} \leq 5.5V$	-5		5	μA
$V_{OL, SDA}$	Output Low Voltage (SDA)	$I_{SDA} = 3mA$			0.4	V
$V_{OL, ALERT}$	Output Low Voltage (\overline{ALERT})	$I_{ALERT} = 1mA$			0.4	V
f_{SCL}	Serial Bus Operating Frequency		10		400	kHz
t_{BUF}	Bus Free Time Between Stop and Start Condition		1.3			μs
t_{HD_SDA}	Hold Time After (Repeated) Start Condition		0.6			μs
t_{SU_SDA}	Repeated Start Condition Setup Time		0.6			μs
t_{SU_STO}	Stop Condition Setup Time		0.6			μs
$t_{HD_DAT(OUT)}$	Data Hold Time		300		900	ns
$t_{HD_DAT(IN)}$	Input Data Hold Time		0			ns
t_{SU_DAT}	Data Set-Up Time		100			ns
t_{LOW}	Clock Low Period		1.3		10000	μs
t_{HIGH}	Clock High Period		0.6			μs
$t_{TIMEOUT_SMB}$	Stuck PMBus Timer	Measured from last PMBus start event		30		ms

Note 1: Stresses beyond those listed under Absolute Maximum Ratings may cause permanent damage to the device. Exposure to any Absolute Maximum Rating condition for extended periods may affect device reliability and lifetime.

Note 2: The LTC3815 is tested under pulsed load conditions such that $T_J \approx T_A$. The LTC3815E is guaranteed to meet specifications from 0°C to 85°C junction temperature. Specifications over the -40°C to 125°C operating junction temperature range are assured by design, characterization and correlation with statistical process controls. The LTC3815I is guaranteed over the -40°C to 125°C operating junction temperature range. Note that the maximum ambient temperature consistent with these specifications is determined by specific operating conditions in conjunction with board layout, the rated package thermal impedance and other environmental factors.

Note 3: The junction temperature (T_J , in °C) is calculated from the ambient temperature (T_A , in °C) and power dissipation (PD, in Watts) according to the formula:

$$T_J = T_A + (PD \cdot \theta_{JA})$$

where θ_{JA} (in °C/W) is the package thermal impedance.

Note 4: The dynamic input supply current is higher due to power MOSFET gate charging ($Q_G \times f_{OSC}$). See applications Information for more information.

Note 5: The LTC3815 is tested in a feedback loop that servos V_{FB} to a referenced voltage with the I_{TH} pin forced to a voltage between 0.6V and 1V.

Note 6: Guaranteed by design, not subject to test.

Note 7: This IC includes overtemperature protection that is intended to protect the device during momentary overload conditions. Junction temperature will exceed 125°C when overtemperature protection is active. Continuous operation above the specified maximum junction temperature may impair device reliability or permanently damage the device.

Note 8: The LTC3815 uses valley current mode control so the current limits specified correspond to the valley of the inductor current waveform. Maximum load current is higher and equals the valley current limit I_{LIM} plus one half of the inductor ripple current.

Note 9: The maximum input and output voltage is 5.5V.

Note 10: Total output accuracy is the sum of the tolerances of I_{REF} , $R_{REF(EXTERNAL)}$, $\Delta V_{OUT,OFFSET}$, and $\Delta I_{REF,LIN} \cdot \Delta V_{IN}$.

TYPICAL PERFORMANCE CHARACTERISTICS

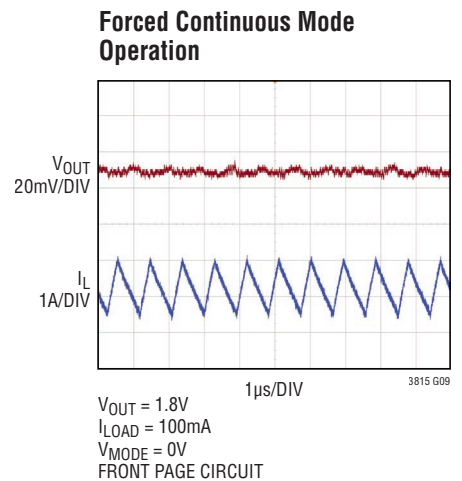
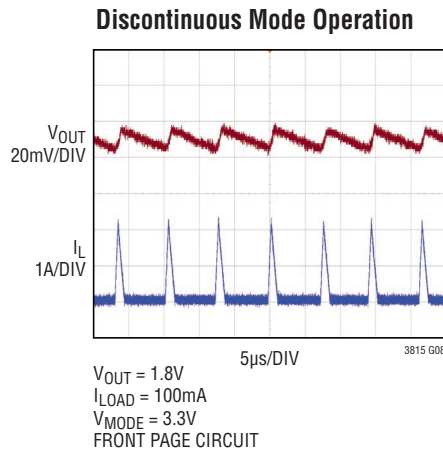
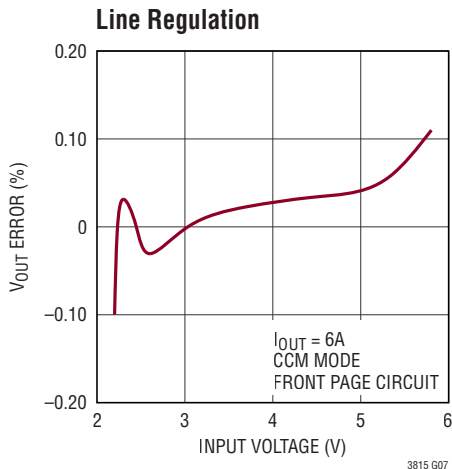
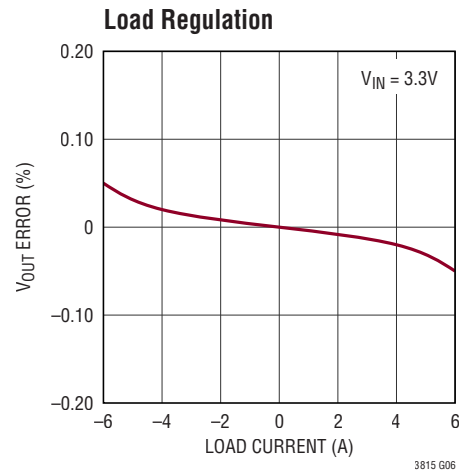
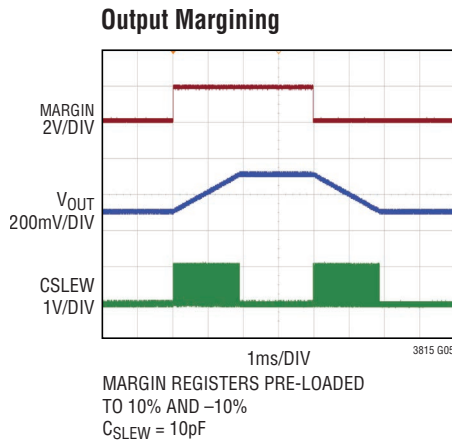
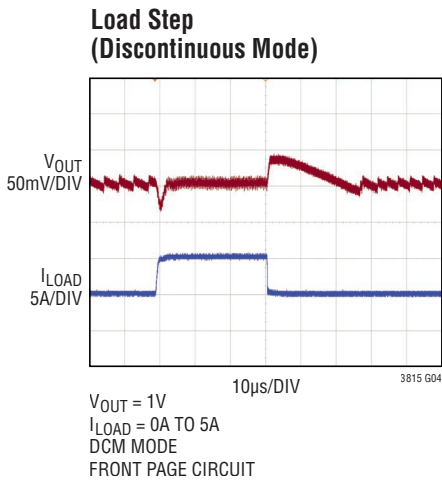
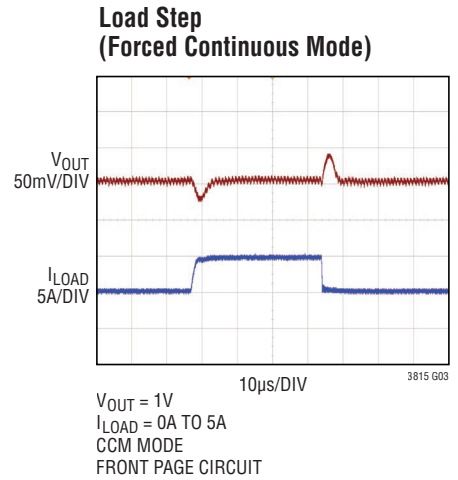
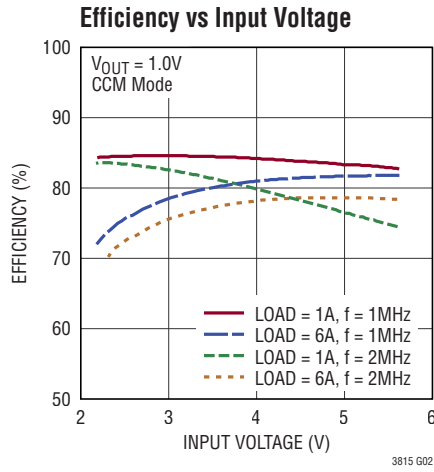
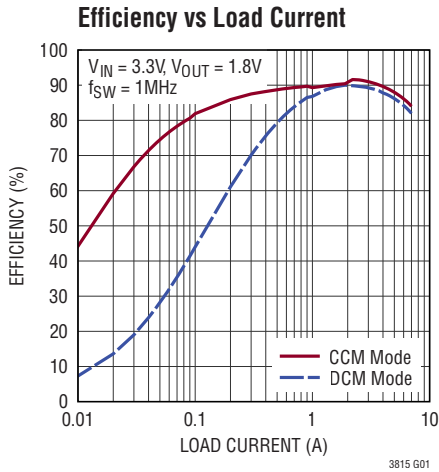

TYPICAL PERFORMANCE CHARACTERISTICS

Valley Current Limit vs Input Voltage

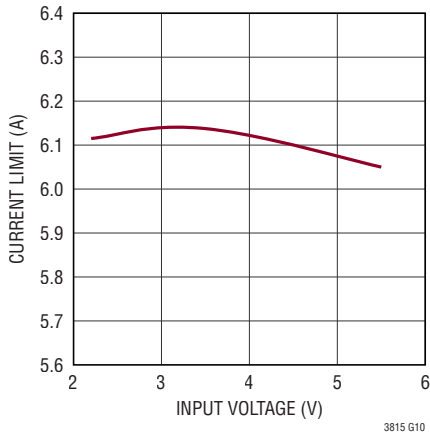

Current Sense Threshold vs ITH Voltage

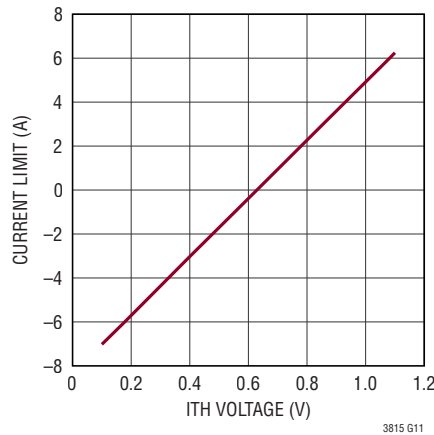

Valley Current Limit vs Temperature

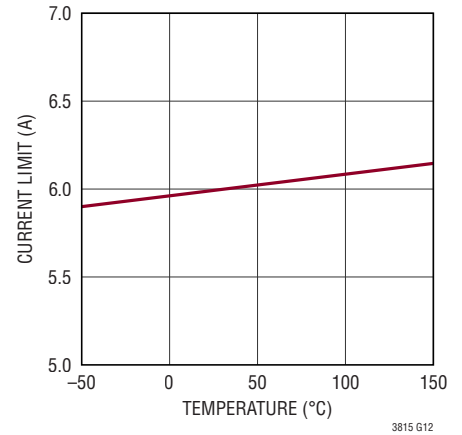

Oscillator Frequency vs Temperature

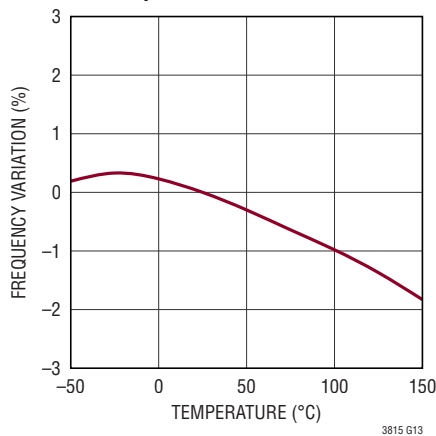

Oscillator Frequency vs Input Voltage

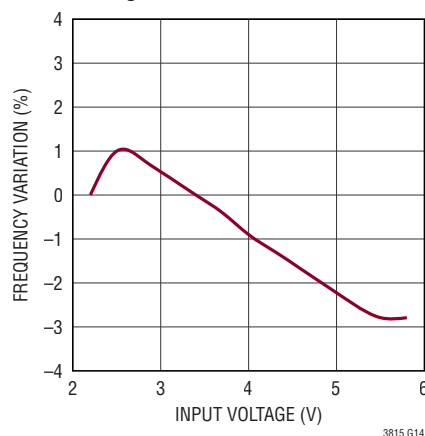

Quiescent Current vs Input Voltage

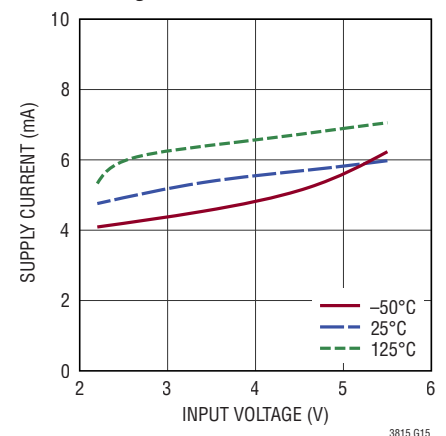

Shutdown Current vs Input Voltage

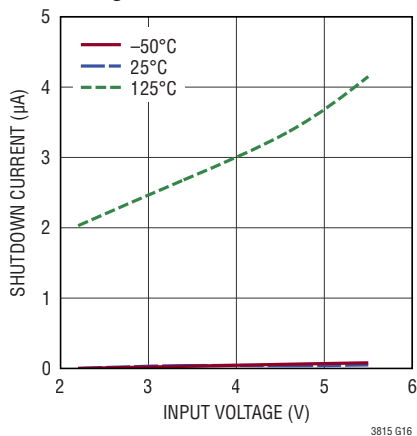

Standby Current vs Input Voltage

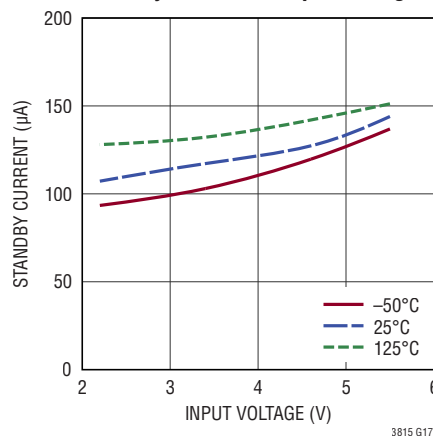

Oscillator Frequency vs RT

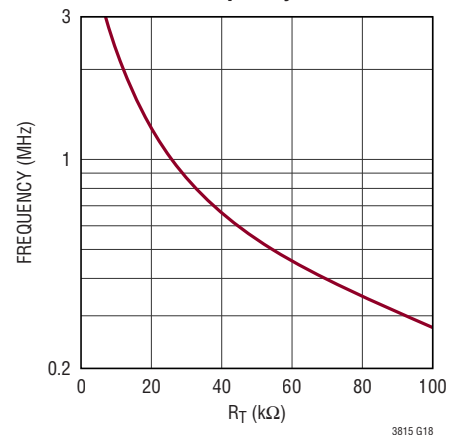

TYPICAL PERFORMANCE CHARACTERISTICS

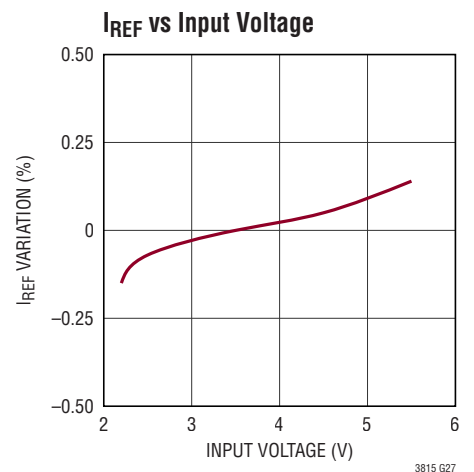
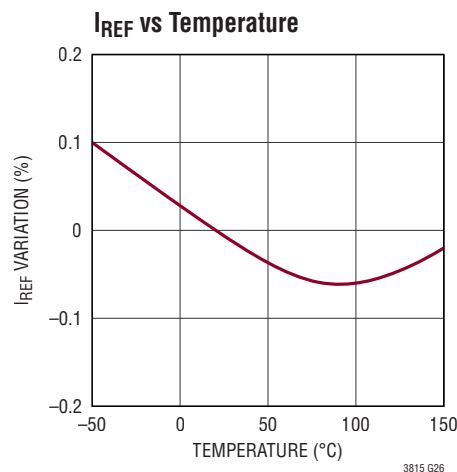
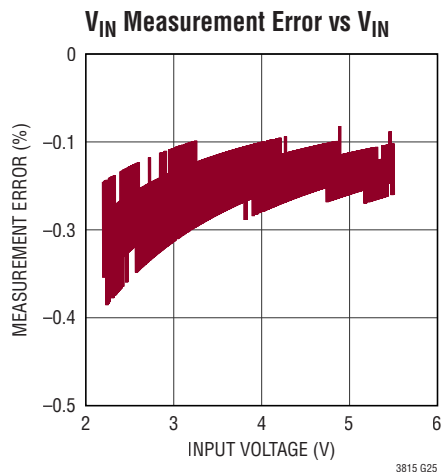
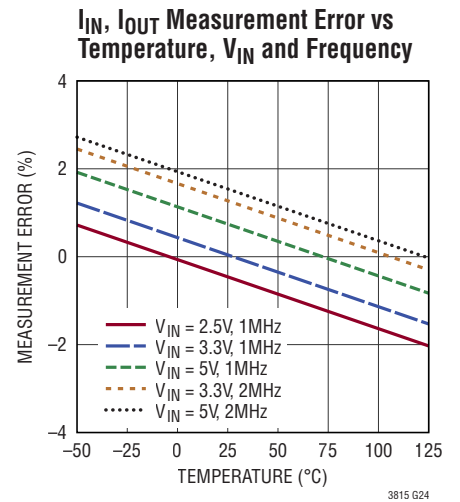
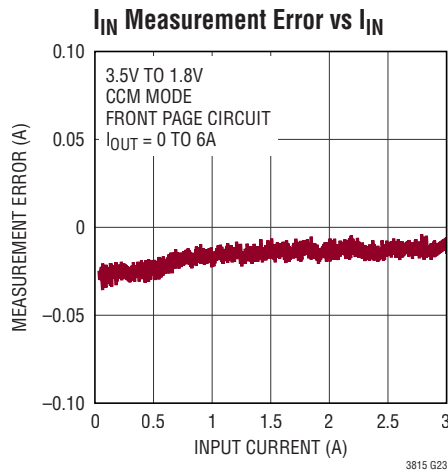
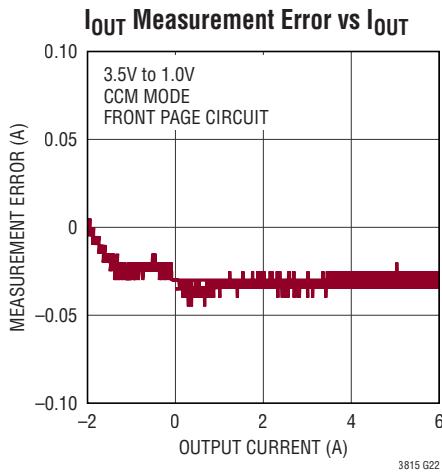
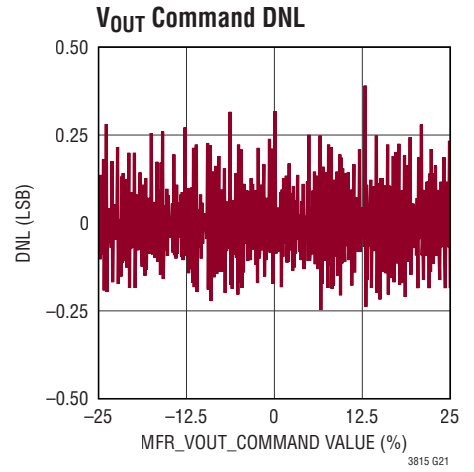
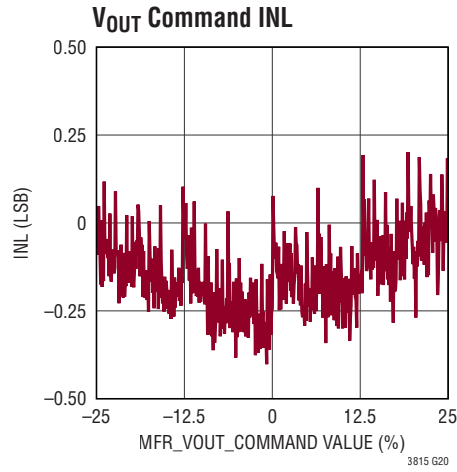
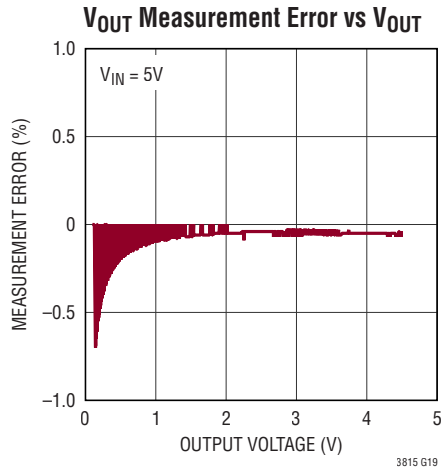

TYPICAL PERFORMANCE CHARACTERISTICS

Normal Start-Up

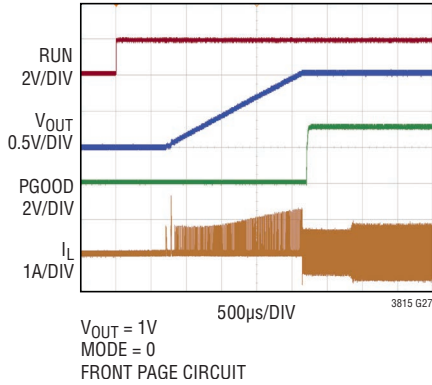

Start-Up Into Pre-Biased Output

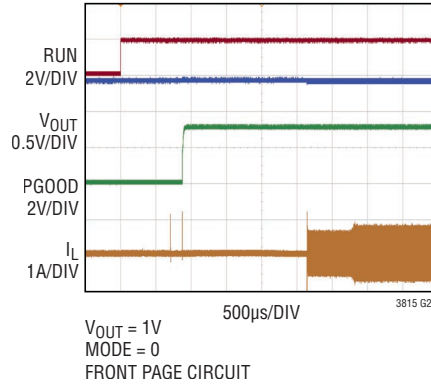

V_{OUT} Short and Recovery

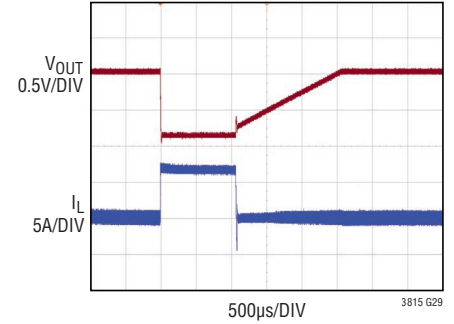

Switch On-Resistance vs Input Voltage

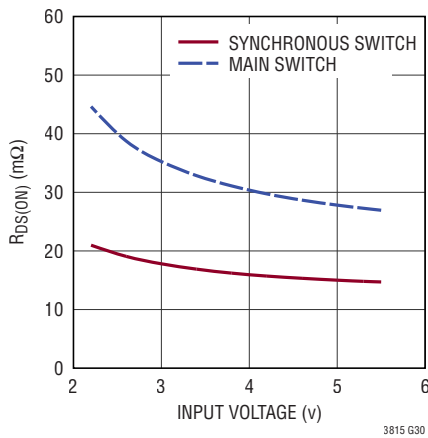

Switch On-Resistance vs Temperature

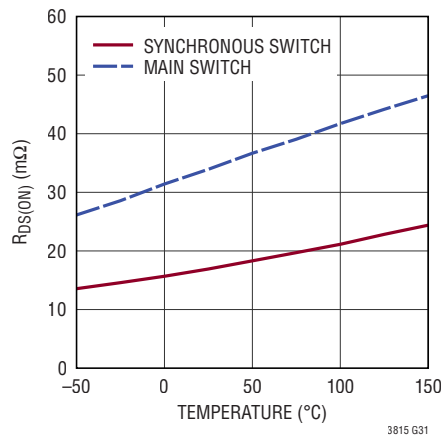

Switch Leakage vs Temperature, Main Switch

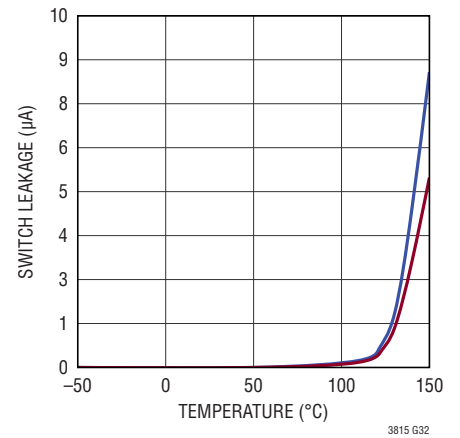

Switch Leakage vs Temperature, Synchronous Switch

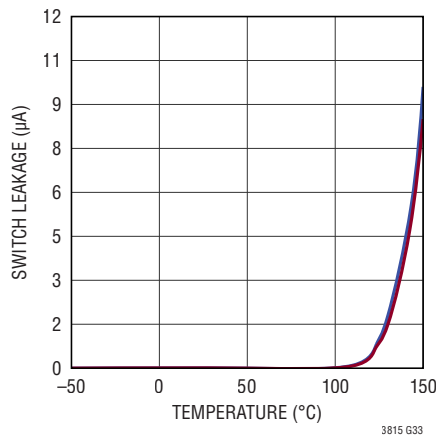

Dynamic Supply Current vs Input Voltage

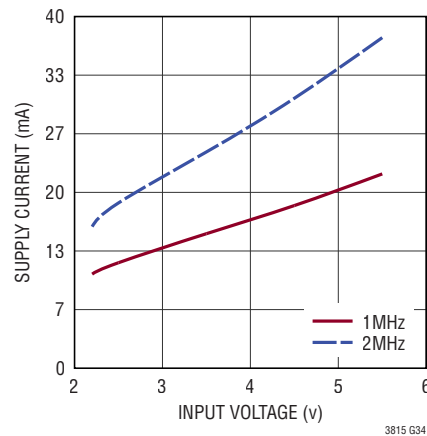

Minimum V_{IN} vs Load, V_{OUT} and Frequency

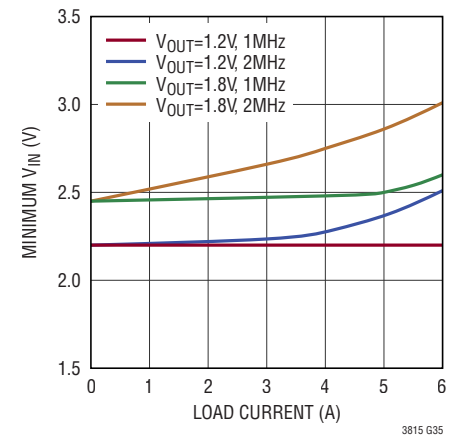

PIN FUNCTIONS

R_T (Pin 1): Oscillator Frequency. This pin provides two modes of setting the constant switching frequency. Connect a resistor from R_T pin to ground to program the switching frequency from 400kHz to 3MHz. Tying this pin to V_{IN} enables the internal 1MHz oscillator frequency.

ASEL (Pin 2): Serial Bus Address Configuration Input. Connect a ±1% resistor from this pin to ground in order to select the 3 LSBs of the serial bus interface address. (see Table 5).

MARGIN (Pin 3): Fast Margining Select. In the default mode when this pin is floating, the reference voltage margin offset is changed with MFR_VOUT_COMMAND through the serial interface. If this pin is pulled high, the reference voltage margin offset is immediately ramped to the value pre-stored in the MFR_VOUT_MARGIN_HIGH register. If this pin is pulled low, the reference voltage margin offset is immediately ramped to the value pre-stored in MFR_VOUT_MARGIN_LOW register.

WP (Pin 4): Write Protect Pin. Pulling this pin high disables writes to MFR_VOUT_COMMAND, MFR_VOUT_MARGIN_HIGH, and MFR_VOUT_MARGIN_LOW. When this pin is grounded, there are no write restrictions.

ALERT (Pin 5): Open Drain Digital Output. Connect the system SMBALERT interrupt signal to this pin. A pull-up resistor is required in the application.

CLKOUT (Pin 6): Clock Out Signal for 2-Phase Operation. The phase of this clock is 180° with respect to the internal clock. Signal swing is from V_{IN} to GND.

SDA (Pin 7): Serial Bus Data Input and Output. A pull-up resistor is required in the application.

SCL (Pin 8): Serial Bus Clock Input. A pull-up resistor is required in the application.

MODE/SYNC (Pin 9): Mode Selection and External Clock Input. If this pin is tied to V_{IN}, discontinuous mode is enabled at light loads. If this pin is connected to ground, forced continuous mode is selected. Driving the MODE/SYNC pin with an external clock signal will synchronize the switching frequency to the applied frequency. There is an internal 20k resistor to ground on this pin.

SW (Pins 10, 11, 13, 14, 18, 19, 21, 22, 23): Switching Node. This pin connects to the drains of the internal main and synchronous power MOSFET switches.

NC (Pins 12, 20): No Connection. Can be connected to ground or left open. This pin does not connect to any internal circuitry.

PV_{IN} (Pins 15-17): Power Input Supply. PV_{IN} connects to the source of the internal P-channel power MOSFET. This pin is independent of V_{IN} and may be connected to the same voltage or to a **lower** voltage supply.

PGOOD (Pin 29): Power Good. This open-drain output is pulled down to SGND on start-up and while the output voltage is outside the power good window set by the PGLIM pin. If the output voltage increases and stays inside the power good window for more than the delay programmed at the PGFD pin, the PGOOD pin is released. If the output voltage leaves the power good window for more than 16 switching cycles the PGOOD pin is pulled down.

V_{IN} (Pin 24): Signal Input Supply. Decouple this pin to SGND with a capacitor. This pin powers the internal control circuitry. This pin is independent of PV_{IN} and may be connected to the same voltage or to a **higher** supply voltage.

PGFD (Pin 25): PGOOD Deglitch Filter Delay Select. The voltage at this pin sets the delay that the output must be in regulation before the PGOOD flag is asserted. The delay can be programmed to one of seven discrete values where $t_{\text{DELAY}} = 200\mu\text{s} \cdot 2^N$ (N = 0 to 5, 7).

RUN_MSTR (Pin 26): Master Run. The power up threshold is set at 1V. When forced below 0.4V, all circuitry is shut off and the IC is put into a low current shutdown mode ($I_Q < 1\mu\text{A}$).

RUN_STBY (Pin 27): Standby Mode Off. The regulator power up threshold is set at 1V. When forced below 0.4V, only the voltage regulator is shut off while the ADC and PMBus interface are still active. When shut off, the ADC refresh rate is reduced to 1Hz and the IC quiescent current is reduced to 120μA. This pin sources 2.5μA. Do not pull up with a low impedance (<10kΩ).

PIN FUNCTIONS

C_{SLEW} (Pin 28): Slew Rate Control. Add a capacitor to program the V_{OUT} transition slew rate during margining. The slew rate is equal to 0.1% per ms per nF slew rate capacitance. With a 1nF capacitor, the slew rate is 0.1%/ms. Two default slew rates are also available when this pin is open or shorted to V_{IN}.

TRACK/SS (Pin 30): Tracking/Soft-Start Input. For soft-start, a capacitor to ground at this pin sets the ramp rate of the output voltage (approximately 5V/sec/μF). For coincident tracking, connect this pin to a resistive divider between the voltage to be tracked and ground.

V_{SS_SENSE} (Pin 31): V_{OUT} Negative Terminal Voltage Sense. The internal unity gain differential gain amplifier connects to the V_{OUT} negative terminal through this pin. Tying this pin to the V_{IN} pin forces the IC to operate as a slave in a two-phase configuration.

V_{CC_SENSE} (Pin 32): V_{OUT} Positive Terminal Voltage Sense. The internal unity gain differential gain amplifier connects to the V_{OUT} positive terminal through this pin.

DA_{OUT} (Pin 33): Differential Amplifier Output.

I_{TH} (Pin 34): Error Amplifier Output and Switching Regulator Compensation Point. The current comparator's trip threshold is linearly proportional to this voltage. Use an RC network between the I_{TH} pin and the V_{FB} pin to compensate the feedback loop for optimum transient response.

FB (Pin 35): Error Amplifier Input. FB will be servoed to the REF pin voltage plus or minus any margining offset set through the serial interface.

REF (Pin 36): Reference Input and Programming Pin. The voltage at this pin is the default reference that the output is regulated to. The PMBus interface allows margining around this default voltage by up to ±25%. This pin can be driven by an external voltage or can be programmed with a resistor to ground. An internal accurate low drift 100μA current source times the external resistor sets the reference voltage.

PGLIM (Pin 37): PGOOD Threshold Programming Pin. The voltage difference ΔV between this pin and SGND sets the V_{OUT} overvoltage threshold to V_{REF} + 0.4 • ΔV and the undervoltage threshold to V_{REF} - 0.4 • ΔV. Tying this pin to V_{IN} sets the threshold to its default value of ±10%.

SGND (Pin 38): Signal Ground. Reference setting resistor, slew rate control capacitor, and frequency setting resistor connections should return to SGND. For optimum load regulation, the SGND pin should be kelvin-connected to the PCB location between the negative terminals of the output capacitors and should not be connected through the PGND plane.

PGND (Exposed Pad Pin 39): Power Ground. Must be soldered to PCB for electrical connection and rated thermal performance.

BLOCK DIAGRAM

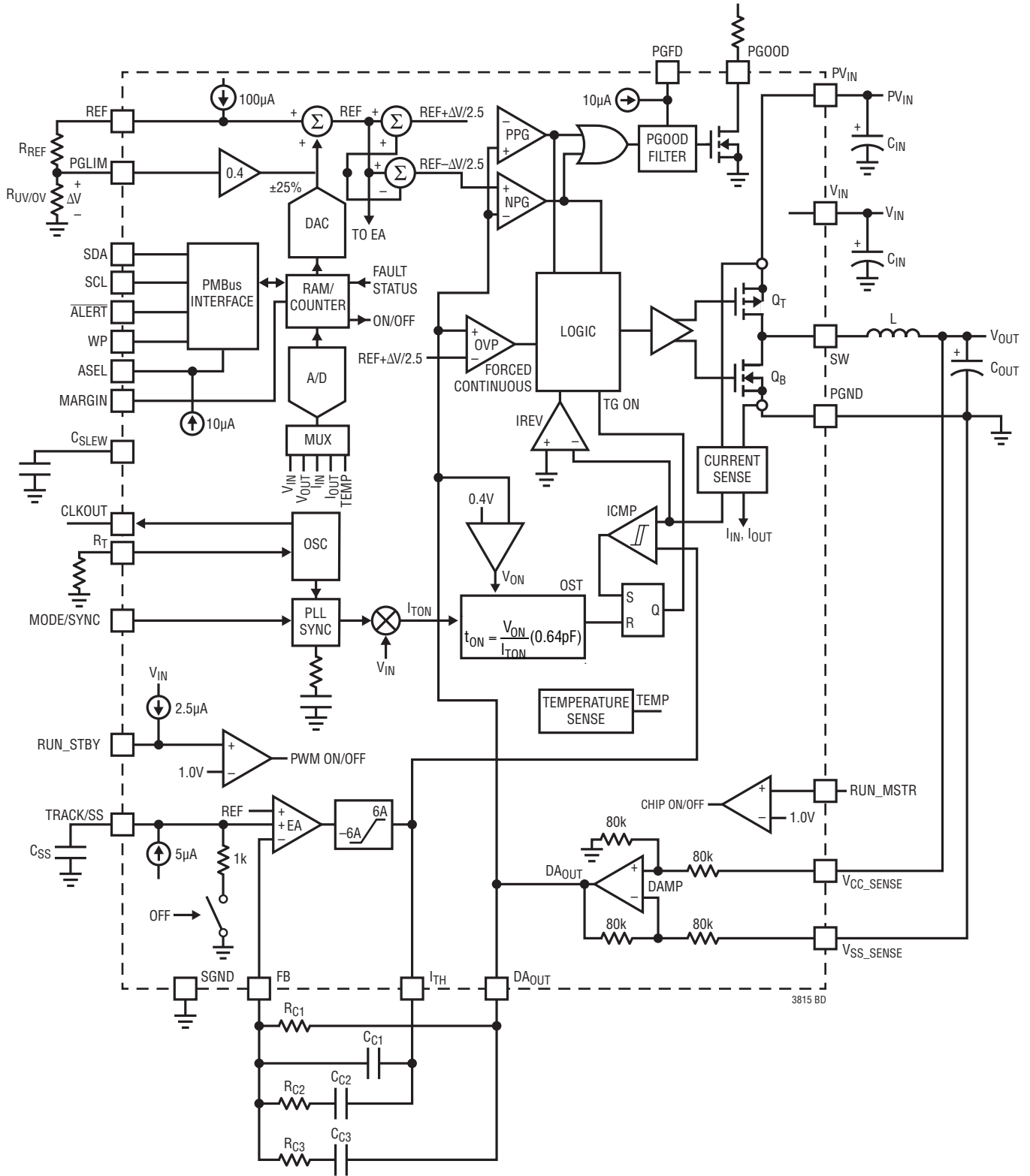

OPERATION

Table 1. LTC3815 Supported PMBus Commands

PMBUS COMMAND CODE	COMMAND NAME	PMBUS-DEFINED SMBUS TRANSACTION TYPE	SCALING	DATA BYTES	DESCRIPTION
0x01	OPERATION	R/W Byte		1	On/Off Command and Set Output to MFR_VOUT_MARGIN_HIGH or MFR_VOUT_MARGIN_LOW value
0x20	VOUT_MODE	Read Byte		1 or 2	Read Data Format for MFR_VOUT_COMMAND Hard-wired to VID format (0x3E), not writable
0x79	STATUS_WORD	R/W Word		2	Read Fault Status: Communication fault, PGOOD, V _{IN} UV, V _{OUT} OV, overtemperature, V _{IN} fault, V _{OUT} fault Individual faults are reset by writing a '1' to the bit position of the fault to be reset
0x88	READ_VIN	R Word	4mV/Bit	2	Read V _{IN}
0x89	READ_IIN	R Word	10mA/Bit	2	Read I _{IN}
0x8B	READ_VOUT	R Word	0.5mV/Bit	2	Read V _{OUT}
0x8C	READ_IOUT	R Word	10mA/Bit	2	Read I _{OUT}
0x8D	READ_TEMPERATURE_1	R Word	1°C/Bit	2	Read Die Temperature (°C)
0x98	PMBUS_REVISION	Read Byte		1 or 2	Read PMBus Revision = 0x22 for Rev 1.2
0xD7	MFR_IOUT_PEAK	R/W Word	10mA/Bit	2	Read highest output current observed since last restart Write will restart peak monitor routine
0xDD	MFR_VOUT_PEAK	R/W Word	0.5mV/Bit	2	Read highest output voltage observed since last restart Write will restart peak monitor routine
0xDE	MFR_VIN_PEAK	R/W Word	4mV/Bit	2	Read highest input voltage observed since last restart Write will restart peak monitor routine
0xDF	MFR_TEMPERATURE1_PEAK	R/W Word	1°C/Bit	2	Read highest temperature observed since last restart Write will restart peak monitor routine
0xE1	MFR_IIN_PEAK	R/W Word	10mA/Bit	2	Read highest input current observed since last restart Write will restart peak monitor routine
0xE3	MFR_CLEAR_PEAKS	W Byte		0, 1 or 2	Clear all peak values, write data is ignored
0xE5	MFR_VOUT_MARGIN_HIGH	R/W Word	0.1%/Bit	2	Same format as MFR_VOUT_COMMAND
0xE7	MFR_SPECIAL_ID	R Word		2	Read 16-bit value (0x8000) that GUI will recognize as LTC3815
0xE8	MFR_VOUT_COMMAND	R/W Word	0.1%/Bit	2	V _{OUT} Margining Command ±25% range at 0.1%/bit in 2's compliment. Defaults to 0% at power-up
0xED	MFR_VOUT_MARGIN_LOW	R/W Word	0.1%/Bit	2	Same format as MFR_VOUT_COMMAND
0xFA	MFR_RAIL_ADDRESS	R/W Byte		1 or 2	Set Common PMBus Address (B6-B0), Clear B7 to enable. Set B7 to disable. Valid addresses are 0x00 to 0x7F.
0xFD	MFR_RESET	W Byte		0, 1 or 2	Reset PMBus Interface and ADC to Power-On State Write data is ignored

OPERATION

Main Control Loop

The LTC3815 is a 6A current mode monolithic step-down regulator with PMBus Interface. The accurate 100 μ A current source on the REF pin allows the user to use just one external resistor to program the output voltage. In normal operation, the internal top power MOSFET is turned on for a fixed interval determined by a one-shot timer, OST. When the top power MOSFET turns off, the bottom power MOSFET turns on until the current comparator, ICMP, trips, restarting the one-shot timer and initiating the next cycle. Inductor current is determined by sensing the voltage drop across the bottom power MOSFET's V_{DS} . The voltage on the I_{TH} pin sets the comparator threshold corresponding to the inductor valley current. The error amplifier, EA, adjusts this I_{TH} voltage by comparing the feedback signal, V_{FB} , from the output voltage with that of voltage on the REF pin. If the load current increases, it causes a drop in the feedback voltage relative to the internal reference. The I_{TH} voltage then rises until the average inductor current matches that of the load current.

At low load current, the inductor current can drop to zero and become negative. This is detected by current reversal comparator, IREV, which then shuts off the bottom power MOSFET, resulting in discontinuous operation. Both power MOSFETs will remain off with the output capacitor supplying the load current until the I_{TH} voltage rises above the zero current level ($\sim 0.6V$) to initiate another cycle. Discontinuous mode operation is disabled by tying the MODE pin to V_{IN} , which forces continuous synchronous operation regardless of output load.

The operating frequency is determined by the value of the R_T resistor, which programs the current for the internal oscillator. The internal phase-lock loop serves the switching regulator on-time to track the internal oscillator to force constant switching frequency. If an external clock signal is detected on the MODE/SYNC pin, the phase-lock loop will servo the on-time to track the external clock signal instead.

V_{OUT} Margining

The LTC3815 has an internal 9-bit DAC that provides up to $\pm 25\%$ adjustment at 0.1%/bit resolution around the reference voltage set at the REF pin. The digital offset value is changed with the MFR_VOUT_COMMAND command

through the PMBus interface. When a change in the reference is detected, the reference is ramped (0.1%/step) from its current value to the new value at a rate set by the capacitor value connected to the C_{SLEW} pin, thus providing programmable slew rate of the V_{OUT} transition. To eliminate the latency of the PMBus transaction when faster changes are required, the LTC3815 can be pre-loaded with two additional offsets with the MFR_VOUT_MARGIN_HIGH and MFR_VOUT_MARGIN_LOW commands. The reference offset can then be switched between any of these three register values with the 3-state MARGIN pin. When using the MARGIN pin, the latency of the V_{OUT} transition is limited only by the chosen C_{SLEW} capacitor and the loop bandwidth of the power supply. Changes to these registers are prevented by pulling the write protect (WP) pin high.

Telemetry Readback

The LTC3815 has an integrated 13-bit ADC that monitors and performs conversions on the input and output voltage, input and output current, and die temperature. The values are refreshed at a 25Hz rate and are readable through the PMBus interface.

A peak monitor is also available for each of these telemetry measurements to provide that highest value measured since the start of the monitor. The monitor is reset by the MFR_CLEAR_PEAKS command, writing to the individual peak register, or de-asserting RUN_MSTR.

Output Voltage Tracking and Soft-Start

The LTC3815 allows the user to program its output voltage ramp rate by means of the TRACK/SS pin. An internal 5 μ A pulls up the TRACK/SS pin to V_{IN} . Putting an external capacitor on TRACK/SS enables soft starting the output to prevent current surge on the input supply. If no capacitor is connected or TRACK/SS pin is connected to V_{IN} , the ramp rate defaults to 1.1 volts/ms. For output tracking applications, TRACK/SS can be externally driven by another voltage source. For TRACK/SS less than the output voltage reference (set by the I_{REF} resistor and margin register), the TRACK/SS voltage will override the reference input to the error amplifier, thus regulating the feedback voltage to that of TRACK/SS pin. During this start-up time, the LTC3815 will operate in discontinuous mode. When TRACK/SS is

OPERATION

above the reference voltage, tracking is disabled and the feedback voltage will regulate to the reference voltage. Either concurrent or ratiometric tracking can be implemented by connecting the track voltage to either the I_{REF} pin or the TRACK/SS pin as described in the applications section.

Output Power Good

When the LTC3815's output voltage is within its power good window of the regulation point, the output voltage is good and the PGOOD pin is pulled high with an external resistor. Otherwise, an internal open-drain pull-down device (40Ω) will pull the PGOOD pin low. This window is programmed by the PGLIM pin by connecting it to a resistive divider to the REF pin. This allows the PGOOD window to be programmed as a percentage of the output voltage reference. If PGLIM is tied to V_{IN} , the PGOOD window defaults to $\pm 10\%$.

The PGOOD Filter Delay pin provides a user-programmable delay from output voltage good to the rising edge of PGOOD. A wide range of delays from $200\mu s$ to 25ms can be user-programmed by a configuration resistor connected to the PGFD pin. To prevent unwanted PGOOD glitches during transients or dynamic V_{OUT} changes, the LTC3815's PGOOD falling edge includes a blanking delay of approximately 16 switching cycles.

Continuous operation is forced during OV and UV condition except during start-up when the TRACK/SS pin is ramping up to the internal reference voltage.

Master Shutdown and Standby Modes

There are three different ways to shut down the LTC3815: RUN_MSTR pin, RUN_STBY pin, and the ON bit of the OPERATION command.

Pulling the RUN_MSTR pin low forces the LTC3815 into a master shutdown state, turning off both power MOSFETs, the internal control circuitry, the ADC converter, and the PMBus interface. Also, all data written to the internal registers, such as the margin register, will be reset to the power-on state. Supply current in this mode is typically less than $1\mu A$.

Pulling RUN_STBY pin low or clearing the ON bit in the OPERATION register puts the LTC3815 in a standby mode where the regulator is off but the ADC and PMBus are still active. In standby mode the LTC3815 will still respond to the PMBus host but will only refresh the telemetry data at 1Hz rate instead of 25Hz. In standby mode the supply current is $120\mu A$. Exiting standby mode with the rising edge of the ON bit resets all faults and the \overline{ALERT} pin. All data written to the internal registers, such as the margin registers, is not affected by this shutdown mode, so when RUN_STBY is re-asserted, the V_{OUT} will power back up to the last value written prior to shutdown (as long as no change to the margin registers or MARGIN pin was made during shutdown).

For the switcher to run and provide output regulation all three must be asserted, i.e. RUN_MSTR and RUN_STBY pins high and OPERATION ON bit set. At power on or master shutdown, the ON bit is automatically set in the OPERATION register. Pulling RUN_MSTR low overrides the standby controls and puts the LTC3815 in master shutdown.

Table 2. Shutdown Modes

INPUT CONDITIONS			ON/OFF STATES			I_Q
RUN_MSTR	RUN_STBY	ON BIT	V_{OUT}	PMBus	ADC	
High	X	0	OFF	ON	1Hz Refresh (see Note)	$120\mu A$
Low	X	X	OFF	OFF	OFF	$<1\mu A$
High	High	1	ON	ON	25Hz Refresh	5mA
High	Low	X	OFF	ON	1Hz Refresh (see Note)	$120\mu A$

Note: Only V_{IN} , V_{OUT} and temperature telemetry are refreshed.

Short Circuit Protection

The LTC3815 has a precision cycle-by-cycle current limit to prevent inductor saturation in a short circuit condition. The valley of the inductor current is guaranteed to not exceed $6A \pm 10\%$. The maximum cycle-by-cycle inductor current is therefore limited to $6A + 10\% + \Delta I_L$, where ΔI_L depends on the inductor valley and operating frequency but is typically $\sim 2A$. Internal control circuitry also guarantees smooth recovery with no output voltage overshoot once the short is removed.

OPERATION

25MHz Error Amplifier and Remote Sense Differential Amplifier

The LTC3815 utilizes a 25MHz error amplifier and differential amplifier for fast and accurate output voltage regulation. The operational amplifier style error amplifier allows precision tuning of the system poles and zeros for optimal transient response. The remote sense differential amplifier allows output voltage sensing at the point-of-load and thus provides very accurate regulation of the output voltage and telemetry readback regardless of load current. The sensed output voltage is available at the DA_{OUT} pin (referenced to SGND). This pin is typically connected to the FB pin which is the error amplifier “-“ input.

Using Separate VIN/PVIN Supplies

The LTC3815 has two supply pins: V_{IN} that supplies the IC control circuitry and PV_{IN} that supplies the driver and power switches. V_{IN} requires a minimum of 2.25V to guarantee proper operation, while PV_{IN} may be able to supply power to the load at lower voltages if the load demands do not exceed the weaker capability of the power switches at the lower voltage. To maximize the lower operating range of the supply voltage, two separate supplies can be used – a V_{IN} supply that is > 2.25V and rated at 10mA or higher and a PV_{IN} supply, rated for the load, that can be run all the way into dropout. Each supply pin has an individual undervoltage-lockout comparator to shut off the supply when its respective voltage is too low to guarantee proper operation.

Thermal Warning and Thermal Shutdown

The LTC3815 has two levels of thermal thresholds and two levels of responses. When the internal die temperature exceeds 150°C, the overtemperature bit in the STATUS_WORD is set and the $\overline{\text{ALERT}}$ pin pulls low to alert the PMBus master. If the temperature continues to rise and exceeds 170°C, the LTC3815 shuts down all circuitry, including output regulation, and will no longer respond to the PMBus host. Both temperature monitors have about 20°C of hysteresis before the overtemperature condition is cleared. The temperature warning bit in the STATUS_WORD is latched and remains set until the host clears it.

2-Phase Operation

For output loads that demand more than 6A of current, two LTC3815's can be paralleled to run out-of-phase to provide up to 12A output current. To configure a 2-phase system, one LTC3815 will act as a master and the other a slave (see the schematic in the Typical Applications section). Connecting the V_{SS_SENSE} pin to V_{IN} puts the LTC3815 in slave mode by tri-stating its error amplifier and remote sense amplifier. The I_{TH} pins of both IC's are connected together so that both are regulating the inductor current based on the master's I_{TH} voltage. The master's CLKOUT pin is a clock waveform that is 180° out-of-phase to its internal clock. This CLKOUT can be connected to the MODE/SYNC pin of the slave to force the slave's PLL to lock onto this clock input and run out-of-phase with the master. The RUN_STBY pins are also connected together as a handshaking signal between the two so that both will shutoff together in case of a fault in only one of the phases, such as overtemperature condition.

See the Applications Information section for further details regarding 2-phase operation.

Discontinuous/Forced Continuous Operation

The LTC3815 can operate in one of two modes selectable with the MODE/SYNC pin: discontinuous mode or forced continuous mode. Connecting the MODE/SYNC pin to V_{IN} selects discontinuous mode. Discontinuous mode is selected when high efficiency at very light loads is desired. In this mode, when the inductor current reverses, the bottom MOSFET turns off to minimize the efficiency loss due to reverse current flow. This reduces the conduction loss and slightly improves the efficiency. As the load reduces, the driver switching frequency drops in proportion to the load, which further improves efficiency by minimizing gate charge losses.

Forcing the MODE/SYNC pin low enables forced continuous mode operation. In forced continuous mode, the bottom MOSFET is always on when the top MOSFET is off, allowing the inductor current to reverse at low currents. This mode is less efficient due to conduction and switching losses, but has the advantage of better transient response at low currents, constant frequency operation, and the ability to maintain regulation when sinking current.

OPERATION

During soft-start, the LTC3815 forces the controller to operate in discontinuous mode until the soft-start voltage reaches the internal reference to guarantee smooth startup into a precharged output capacitor. During margining transitions and overvoltage conditions, however, the LTC3815 always operates in forced continuous mode to allow the switcher to sink current.

SERIAL INTERFACE

The LTC3815 serial interface is a PMBus compliant slave device and can operate at any frequency between 10kHz and 400kHz. The address is configurable using an external resistor. In addition the LTC3815 always responds to the global broadcast address of 0x5A or 0x5B (7 bit). The serial interface supports the following protocols defined in the PMBus specifications: 1) send command, 2) write byte, 3) write word, 4) group, 5) read byte and 6) read word. The PMBus write operations are not acted upon until a complete valid message is received by the LTC3815 including the STOP bit.

Communication Failure

Attempts to access unsupported commands or writing invalid data to supported commands will result in a CML fault. The CML bit is set in the STATUS_WORD command and the $\overline{\text{ALERT}}$ pin is pulled low.

Device Addressing

The LTC3815 offers four different types of addressing over the PMBus interface, specifically: 1) global, 2) device, 3) rail addressing and 4) alert response address (ARA).

Global addressing provides a means of the PMBus master to address all LTC3815 devices on the bus. The LTC3815 global address is fixed 0x5A or 0x5B (7 bit) or 0xB4 or 0xB6 (8 bit) and cannot be disabled.

Device addressing provides the standard means of the PMBus master communicating with a single instance of an LTC3815. The value of the device address is set by the ASEL configuration pin. Rail addressing provides a means of the PMBus master addressing a set of channels connected to the same output rail, simultaneously. This is similar to

global addressing, however, the PMBus address can be dynamically assigned by using the MFR_RAIL_ADDRESS command. It is recommended that rail addressing should be limited to command write operations.

All four means of PMBus addressing require the user to employ disciplined planning to avoid addressing conflicts.

Fault Status

The STATUS_WORD and $\overline{\text{ALERT}}$ pin provide fault status information of the LTC3815 to the host.

Bus Timeout Failure

The LTC3815 implements a timeout feature to avoid hanging the serial interface. The data packet timer begins at the first START event before the device address write byte. Data packet information must be completed within 25ms or the LTC3815 will tri-state the bus and ignore the given data packet. Data packet information includes the device address byte write, command byte, repeat start event (if a read operation), device address byte read (if a read operation), and all data bytes.

The user is encouraged to use as high a clock rate as possible to maintain efficient data packet transfer between all devices sharing the serial bus interface. The LTC3815 supports the full PMBus frequency range from 10kHz to 400kHz.

Similarity Between PMBus, SMBus and I²C 2-Wire Interface

The PMBus 2-wire interface is an incremental extension of the SMBus. SMBus is built upon I²C with some minor differences in timing, DC parameters and protocol. The PMBus/SMBus protocols are more robust than simple I²C byte commands because PMBus/SMBus provide time-outs to prevent bus hangs and optional packet error checking (PEC) to ensure data integrity. In general, a master device that can be configured for I²C communication can be used for PMBus communication with little or no change to hardware or firmware. Repeat start (restart) is not supported by all I²C controllers but is required for SMBus/PMBus reads. If a general purpose I²C controller is used, check that repeat start is supported.

OPERATION

For a description of the minor extensions and exceptions PMBus makes to SMBus, refer to PMBus Specification Part 1 Revision 1.1: Paragraph 5: Transport.

For a description of the differences between SMBus and I²C, refer to System Management Bus (SMBus) Specification Version 2.0: Appendix B—Differences Between SMBus and I²C.

PMBus Serial Interface

The LTC3815 communicates with a host (master) using the standard PMBus serial bus interface. The Timing Diagram, Figure 1, shows the timing relationship of the signals on the bus. The two bus lines, SDA and SCL, must be high when the bus is not in use. External pull-up resistors or current sources are required on these lines.

The LTC3815 is a slave device. The master can communicate with the LTC3815 using the following formats:

- Master transmitter, slave receiver
- Master receiver, slave transmitter

The following PMBus protocols are supported:

- Write Byte, Write Word, Send Byte
- Read Byte, Read Word
- Alert Response Address

Figures 3 through 6 illustrate the aforementioned PMBus protocols. All transactions support GCP (group command protocol).

Figure 2 is a key to the protocol diagrams in this section.

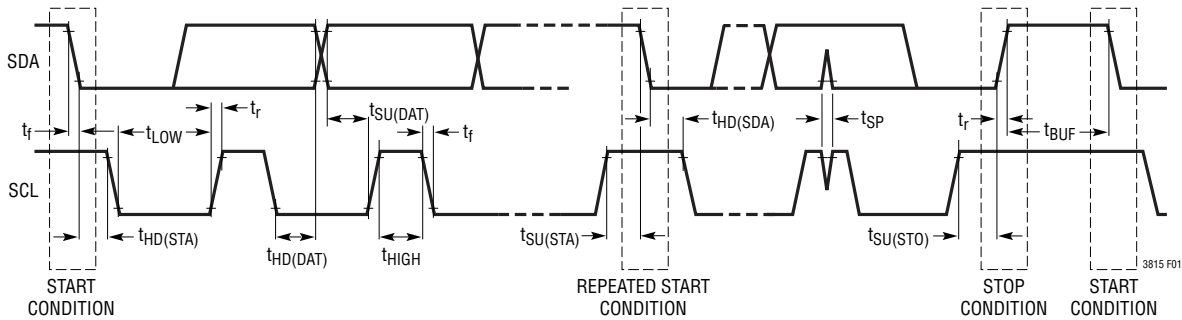

Figure 1. Timing Diagram

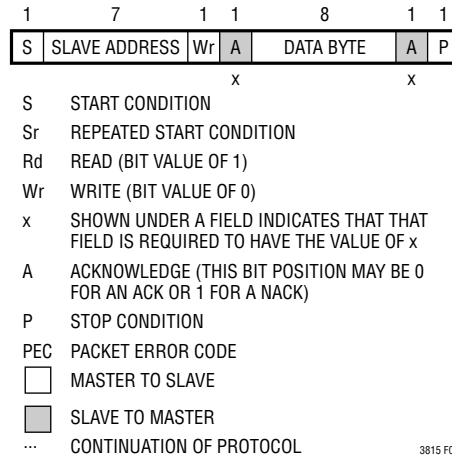

Figure 2. PMBus Packet Protocol Diagram Element Key

OPERATION

A value shown below a field in the following figures is a mandatory value for that field.

The data formats implemented by PMBus are:

- Master transmitter transmits to slave receiver. The transfer direction in this case is not changed.
- Master reads slave immediately after the first byte. At the moment of the first acknowledgment (provided by the slave receiver) the master transmitter becomes a master receiver and the slave receiver becomes a slave transmitter.
- Combined format. During a change of direction within a transfer, the master repeats both a start condition and the slave address but with the R/\overline{W} bit reversed. In this case, the master receiver terminates the transfer by generating a NACK on the last byte of the transfer and a STOP condition.

Examples of these formats are shown in Figures 3 through 7.

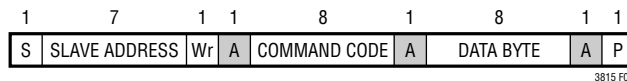

Figure 3. Write Byte Protocol

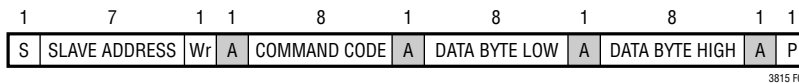

Figure 4. Write Word Protocol

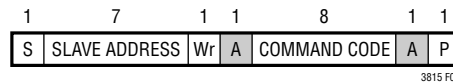

Figure 5. Send Byte Protocol

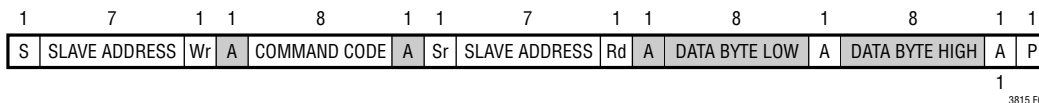

Figure 6. Read Word Protocol

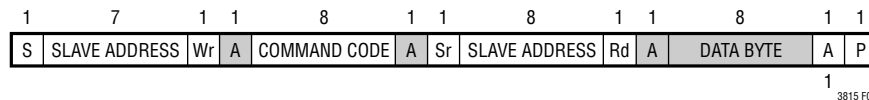

Figure 7. Read Byte Protocol

APPLICATIONS INFORMATION

The basic LTC3815 application circuit is shown in Figure 8.

Operating Frequency

Selection of the operating frequency is a trade-off between efficiency and component size. High frequency operation allows the use of smaller inductor and capacitor values. Operation at lower frequencies improves efficiency by reducing internal gate charge losses but requires larger inductance values and/or capacitance to maintain low output ripple voltage. The operating frequency of the LTC3815 is determined by an external resistor that is connected between the RT pin and ground. The value of the resistor sets the ramp current that is used to charge and discharge an internal timing capacitor within the oscillator and can be calculated by using the following equation:

$$R_T = \frac{1.15 \cdot 10^{11}}{(f_{osc})^{1.11}} \Omega$$

Frequencies as high as 3MHz are possible, as long as the minimum on-time requirement is met (see next section).

Tying the RT pin to V_{IN} sets the default internal operating frequency to 1MHz ±15%.

The LTC3815's internal oscillator can be synchronized to an external frequency by applying a square wave clock signal to the MODE/SYNC pin. During synchronization, the top switch turn-on is locked to the rising edge of the external frequency source. The synchronization frequency range is 300kHz to 3MHz. During synchronization, discontinuous operation is disabled.

The internal PLL has a synchronization range of ±30% around its programmed frequency. Therefore, during external clock synchronization be sure that the external clock frequency is within this ±30% range of the R_T programmed frequency.

When using the RT pin to program the oscillator frequency, a square wave clock that is running 180° out-of-phase with the internal oscillator is available at the CLKOUT pin for connection to a second LTC3815 for 2-phase operation (see the 2-Phase section).

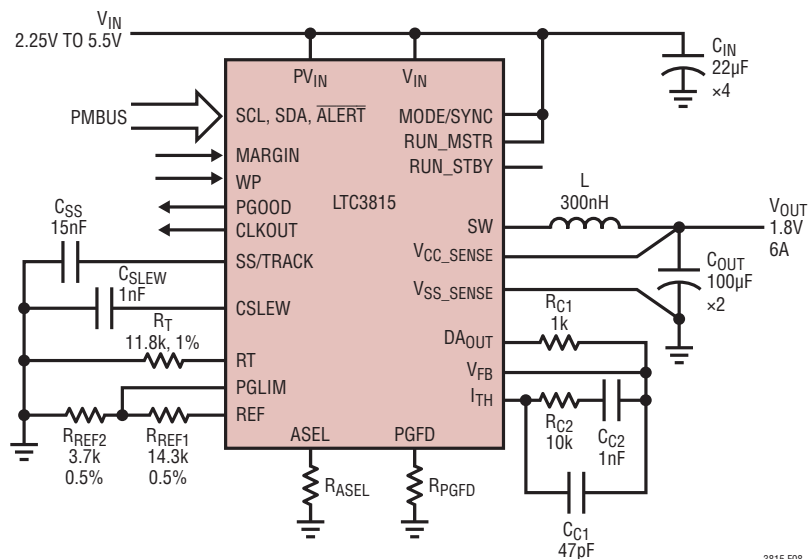

Figure 8. 1.8V, 6A Step-Down Regulator

3815 F08

APPLICATIONS INFORMATION

Minimum Off-Time and Minimum On-Time Considerations

The minimum off-time, $t_{OFF(MIN)}$, is the smallest amount of time that the LTC3815 is capable of turning on the bottom power MOSFET, tripping the current comparator and turning the power MOSFET back off. This time is generally about 100ns. The minimum off-time limit imposes a maximum duty cycle of $t_{ON}/(t_{ON} + t_{OFF(MIN)})$. If the maximum duty cycle is reached, due to a dropping input voltage for example, then the output will drop out of regulation. The minimum input voltage to avoid dropout is:

$$V_{IN(MIN)} = V_{OUT} \cdot \frac{t_{ON} + t_{OFF(MIN)}}{t_{ON}}$$

Conversely, the minimum on-time is the smallest duration of time in which the top power MOSFET can be in its “on” state. This time is typically 75ns. In continuous mode operation, the minimum on-time limit imposes a minimum duty cycle of:

$$DC_{MIN} = f \cdot t_{ON(MIN)}$$

where $t_{ON(MIN)}$ is the minimum on-time. As the equation shows, reducing the operating frequency will alleviate the minimum duty cycle constraint.

In the cases where the minimum duty cycle is surpassed, the output voltage will still remain in regulation, but the switching frequency will decrease from its programmed value. This is an acceptable result in many applications, so this constraint may not be of critical importance in most cases. High switching frequencies may be used in the design without any fear of severe consequences. As the sections on inductor and capacitor selection show, high switching frequencies allow the use of smaller board components, thus reducing the size of the application circuit.

Inductor Selection

Given the desired input and output voltages, the inductor value and operating frequency determine the ripple current:

$$\Delta I_L = \frac{V_{OUT}}{f \cdot L} \cdot \left(1 - \frac{V_{OUT}}{V_{IN}}\right)$$

Lower ripple current reduces core losses in the inductor, ESR losses in the output capacitors and output voltage ripple. Highest efficiency operation is obtained at low frequency with small ripple current. However, achieving this requires a large inductor. There is a trade-off between component size, efficiency and operating frequency.

A reasonable starting point is to choose a ripple current that is about 30-40% of $I_{OUT(MAX)}$. This is especially important at low V_{OUT} operation where V_{OUT} is 1.8V or below. Care must be given to choose an inductance value that will generate a big enough current ripple so that the chip’s valley current comparator has enough signal-to-noise ratio to force constant switching frequency. Meanwhile, also note that the largest ripple current occurs at the highest V_{IN} . To guarantee that ripple current does not exceed a specified maximum, the inductance should be chosen according to:

$$L = \frac{V_{OUT}}{f \cdot \Delta I_L(MAX)} \cdot \left(1 - \frac{V_{OUT}}{V_{IN(MAX)}}\right)$$

Once the value for L is known, the type of inductor must be selected. Actual core loss is independent of core size for a fixed inductor value, but is very dependent on the inductance selected. As the inductance or frequency increases, core losses decrease. Unfortunately, increased inductance requires more turns of wire and therefore copper losses will increase.

Ferrite designs have very low core losses and are preferred at high switching frequencies, so design goals can concentrate on copper loss and preventing saturation. Ferrite core material saturates “hard”, which means that LTC3815 inductance collapses abruptly when the peak design current is exceeded. This results in an abrupt increase in inductor ripple current and consequent output voltage ripple. Do not allow the core to saturate!

Different core materials and shapes will change the size/current and price/current relationship of an inductor. Toroid or shielded pot cores in ferrite or permalloy materials are small and don’t radiate much energy, but generally cost more than powdered iron core inductors with similar characteristics. The choice of which style inductor to use

APPLICATIONS INFORMATION

mainly depends on the price versus size requirements and any radiated field/EMI requirements. New designs for surface mount inductors are available from Toko, Vishay, NEC/Tokin, Cooper, TDK, Würth Elektronik and Coilcraft. Refer to Table 3 for more details.

Table 3. Representative Surface Mount Inductors

INDUCTANCE (μH)	DCR ($\text{m}\Omega$)	MAX CURRENT (A)	DIMENSIONS (mm)	HEIGHT (mm)
Coilcraft XAL6030 Series				
0.18	1.59	39	6.56 × 3.36	3.1
0.33	2.30	30	6.56 × 3.36	3.1
0.56	3.01	29	6.56 × 3.36	3.1
Würth 744316 Series				
0.18	1.25	25	5.5 × 5.2	4
0.33	1.75	20	5.5 × 5.2	4
0.47	2.75	16	5.5 × 5.2	4
0.68	4.00	13.5	5.5 × 5.2	4

C_{IN} and C_{OUT} Selection

The input capacitance, C_{IN} , is needed to filter the trapezoidal wave current at the drain of the top power MOSFET. To prevent large voltage transients from occurring, a low ESR input capacitor sized for the maximum RMS current should be used. The maximum RMS current is given by:

$$I_{\text{RMS}} \cong I_{\text{OUT(MAX)}} \frac{V_{\text{OUT}}}{V_{\text{IN}}} \sqrt{\frac{V_{\text{IN}}}{V_{\text{OUT}}} - 1}$$

This formula has a maximum at $V_{\text{IN}} = 2V_{\text{OUT}}$, where

$$I_{\text{RMS}} \cong I_{\text{OUT}}/2.$$

This simple worst-case condition is commonly used for design because even significant deviations do not offer much relief. Note that ripple current ratings from capacitor manufacturers are often based on only 2000 hours of life which makes it advisable to further derate the capacitor, or choose a capacitor rated at a higher temperature than required.

Several capacitors may also be paralleled to meet size or height requirements in the design. For low input voltage applications, sufficient bulk input capacitance is needed to minimize transient effects during output load changes.

The selection of C_{OUT} is determined by the effective series resistance (ESR) that is required to minimize voltage ripple and load step transients as well as the amount of bulk capacitance that is necessary to ensure that the control loop is stable. Loop stability can be checked by viewing the load transient response. The output ripple, ΔV_{OUT} , is determined by:

$$\Delta V_{\text{OUT}} < \Delta I_{\text{L}} \left(\frac{1}{8 \cdot f \cdot C_{\text{OUT}}} + \text{ESR} \right)$$

The output ripple is highest at maximum input voltage since ΔI_{L} increases with input voltage. Multiple capacitors placed in parallel may be needed to meet the ESR and RMS current handling requirements. Dry tantalum, special polymer, aluminum electrolytic, and ceramic capacitors are all available in surface mount packages. Special polymer capacitors are very low ESR but have lower capacitance density than other types. Tantalum capacitors have the highest capacitance density but it is important to only use types that have been surge tested for use in switching power supplies. Aluminum electrolytic capacitors have significantly higher ESR, but can be used in cost-sensitive applications provided that consideration is given to ripple current ratings and long-term reliability. Ceramic capacitors have excellent low ESR characteristics and small footprints. Their relatively low value of bulk capacitance may require multiples in parallel.

Using Ceramic Input and Output Capacitors

Higher value, lower cost ceramic capacitors are now becoming available in smaller case sizes. Their high ripple current, high voltage rating and low ESR make them ideal for switching regulator applications. However, care must be taken when these capacitors are used at the input and output. When a ceramic capacitor is used at the input and the power is supplied by a wall adapter through long wires, a load step at the output can induce ringing at the V_{IN} input. At best, this ringing can couple to the output and be mistaken as loop instability. At worst, a sudden inrush of current through the long wires can potentially cause a voltage spike at V_{IN} large enough to damage the part.

APPLICATIONS INFORMATION

When choosing the input and output ceramic capacitors, choose the X5R and X7R dielectric formulations. These dielectrics have the best temperature and voltage characteristics of all the ceramics for a given value and size.

Since the ESR of a ceramic capacitor is so low, the input and output capacitor must instead fulfill a charge storage requirement. During a load step, the output capacitor must instantaneously supply the current to support the load until the feedback loop raises the switch current enough to support the load. The time required for the feedback loop to respond is dependent on the compensation and the output capacitor size. Typically, 3 to 4 cycles are required to respond to a load step, but only in the first cycle does the output drop linearly. The output droop, V_{DROOP} , is usually about 2 to 3 times the linear drop of the first cycle. Thus, a good place to start with the output capacitor value is approximately:

$$C_{\text{OUT}} \approx 2.5 \frac{\Delta I_{\text{OUT}}}{f_0 \cdot V_{\text{DROOP}}}$$

More capacitance may be required depending on the duty cycle and load step requirements.

In most applications, the input capacitor is merely required to supply high frequency bypassing, since the impedance to the supply is very low. A 22 μF ceramic capacitor is usually enough for these conditions. Place this input capacitor as close to the PV_{IN} pins as possible.

Checking Transient Response

The regulator loop response can be checked by looking at the load current transient response. Switching regulators take several cycles to respond to a step in load current. When a load step occurs, V_{OUT} immediately shifts by an amount equal to $\Delta I_{\text{LOAD}} \cdot \text{ESR}$, where ESR is the effective series resistance of C_{OUT} . ΔI_{LOAD} also begins to charge or discharge C_{OUT} generating a feedback error signal used by the regulator to return V_{OUT} to its LTC3815 steady-state value. During this recovery time, V_{OUT} can be monitored for overshoot or ringing that would indicate a stability problem.

The OPTI-LOOP compensation allows the transient response to be optimized for a wide range of output capacitors. The availability of the I_{TH} pin not only allows optimization of the control loop behavior but also provides a DC-coupled and AC-filtered closed-loop response test point. The DC step, rise time and settling at this test point truly reflects the closed-loop response. Assuming a predominantly second order system, phase margin and/or damping factor can be estimated using the percentage of overshoot seen at this pin.

The I_{TH} external components (R_{C1} , C_{C1} , C_{C2}) shown in the Figure 8 circuit provides an adequate starting point for most applications. The values can be modified slightly (from 0.5 to 2 times their suggested values) to optimize transient response once the final PC layout is done and the particular output capacitor type and value have been determined. The output capacitors need to be selected because their various types and values determine the loop feedback factor gain and phase. An output current pulse of 20% to 100% of full load current having a rise time of 1 μs to 10 μs will produce output voltage and I_{TH} pin waveforms that will give a sense of the overall loop stability without breaking the feedback loop.

In some applications, a more severe transient can be caused by switching in loads with large (>10 μF) input capacitors. The discharged input capacitors are effectively put in parallel with C_{OUT} , causing a rapid drop in V_{OUT} . No regulator can deliver enough current to prevent this problem, if the switch connecting the load has low resistance and is driven quickly. The solution is to limit the turn-on speed of the load switch driver. A Hot Swap™ controller is designed specifically for this purpose and usually incorporates current limiting, short-circuit protection and soft-starting.

Calculating Compensation Values

If the “trial and error” approach described in the previous section doesn’t result in adequate transient performance, the procedure described in this section can be used to calculate more precise compensation component values to achieve a desired bandwidth and phase margin. This procedure is also helpful if the output capacitor type is

APPLICATIONS INFORMATION

very different than the one specified in the application circuits or if a Type 3 compensation network is required. A Type 3 compensation network includes the additional components R_{C3} and C_{C3} shown in Figure 9.

- 1) Choose the crossover frequency. For best performance, the crossover frequency should be as high as possible but not greater than about 20% of the switching frequency.
- 2) Plot Gain and Phase of the modulator and output filter. The modulator and output filter is the portion of the loop from the error amp output (I_{TH}) to the regulator output (V_{OUT}). To do this, insert a 10Ω to 50Ω resistor between the output capacitor and the V_{CCSEN} pin (this is R7 on the DC2065 demo board). Then use a network analyzer to inject an AC signal across this resistor and plot the Gain and Phase. If a network analyzer is not available, a close approximation can be obtained with a PSPICE simulator using the LTC3815 power supply model shown in Figure 9. The error amplifier EA can

be modeled as an ideal op amp (for crossover frequencies $< 200\text{kHz}$) and the inductor as a voltage controlled current source. The gain/phase plot should look similar to Figure 10.

- 3) Calculate the component values. Once the gain and phase are known, note the gain (GAIN, in dB) and phase (PHASE, in degrees) at the crossover frequency. The compensation components can then be calculated to make the loop gain (V_{CCSEN} to V_{OUT}) equal to 0dB and the phase margin equal to 60° at this frequency. Use the equations below to calculate the component values. Normally the Type 2 network will provide the required phase margin. If not, use the Type 3 equations.
- 4) Add the calculated components to the LTC3815 circuit and check the load step response. If not adequate, the components values may need to be tweaked further or recalculated with a lower crossover frequency until the desired response is obtained.

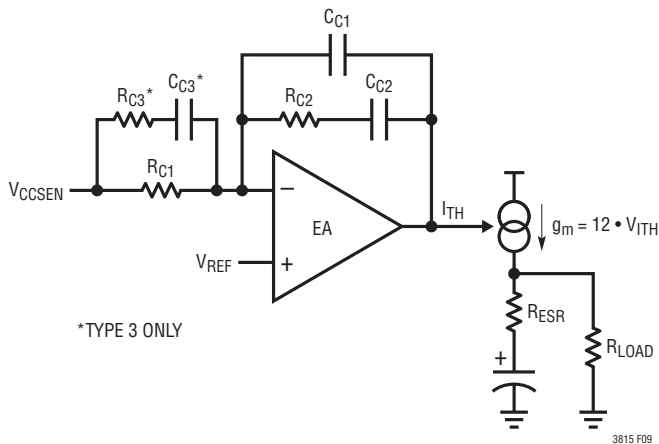

Figure 9. PSPICE Model of a LTC3815 Current Mode Regulator

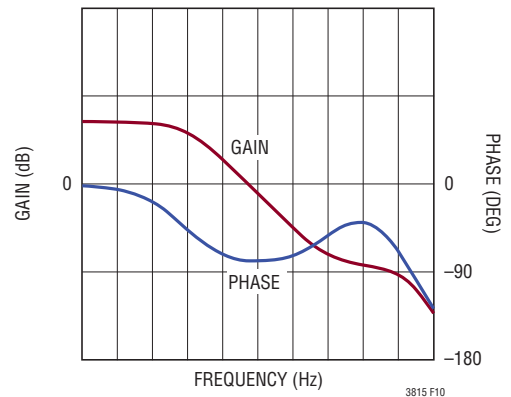

Figure 10. Transfer Function of Buck Modulator

APPLICATIONS INFORMATION

R_{C1} = A convenient resistor value $\sim 1k\Omega$.

f = chosen crossover frequency

$G = 10^{(GAIN/20)}$ (this converts GAIN in dB to G in absolute gain)

Type 2 Loop:

$$k = \tan\left(\frac{BOOST}{2} + 45^\circ\right)$$

$$C_{C1} = \frac{1}{2\pi \cdot f \cdot G \cdot K \cdot R_{C1}}$$

$$C_{C2} = C_{C1}(K^2 - 1)$$

$$R_{C2} = \frac{K}{2\pi \cdot f \cdot C_{C2}}$$

$$R_B = \frac{V_{REF}(R_{C1})}{V_{OUT} - V_{REF}}$$

Type 3 Loop:

$$k = \tan\left(\frac{BOOST}{4} + 45^\circ\right)$$

$$C_{C1} = \frac{1}{2\pi \cdot f \cdot G \cdot RC1}$$

$$C_{C2} = C_{C1}(K - 1)$$

$$R_{C2} = \frac{\sqrt{K}}{2\pi \cdot f \cdot C_{C2}}$$

$$R_{C3} = \frac{R_{C1}}{K - 1}$$

$$C3 = \frac{1}{2\pi f \sqrt{K} \cdot R_{C3}}$$

$$R_B = \frac{V_{REF}(R_{C1})}{V_{OUT} - V_{REF}}$$

Output Voltage Programming

The output voltage is set by an external resistor according to the following equation:

$$V_{OUT} = 100\mu A \cdot R_{REF},$$

where R_{REF} is the total resistance between REF pin and SGND.

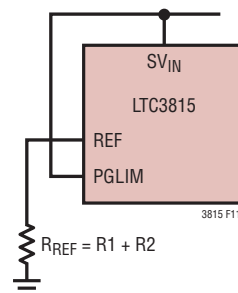

Figure 11a. PGOOD Window Set to $\pm 10\%$ Default

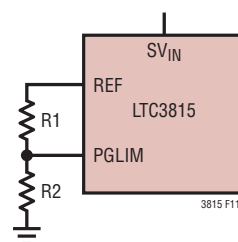

Figure 11b. PGOOD Window Set By R1/R2

Figure 11. PGOOD Window

Programming PGOOD Threshold and Filter Delay

The upper and lower Power Good threshold default to $\pm 10\%$ when the PGLIM pin is tied to V_{IN} (see Figure 11a). However, if a narrower or wider window is desired, these windows can be programmed to any desired value in the range of 5% to 40%.

The PGOOD upper/lower threshold is programmed by replacing the single resistor on the REF pin with a resistor divider as follows (see Figure 11b):

$$\text{Reference Voltage} = 100\mu A \cdot (R1 + R2)$$

$$\text{PGOOD Window} = \pm 40\% \cdot R2 / (R1 + R2)$$

The PGOOD window is always centered on the DAC adjusted reference voltage, thus the center will move to the new reference voltage when margined up or down.

The falling PGOOD (power good to power bad) is filtered and delayed by 16 clock cycles, thus giving the loop 16 switching cycles to recover from the power bad condition before pulling the PGOOD pin low.

The rising PGOOD (power bad to power good) filter delay is user programmable by a configuration resistor at the PGFD pin and is programmable to one of 7 possible delays from

APPLICATIONS INFORMATION

200 μ s to 25.6ms as shown in Table 4. Minimum delay of 200 μ s can be set by grounding the PGLIM pin and maximum delay of 25.6ms can be set by tying PGLIM to SV_{IN}.

The PGFD pin is sampled only at power on and at initialization after the rising edge of RUN_MSTR, RUN_STBY or the OPERATION register ON bit. Changes to PGFD will not take effect until one of these events occur.

Table 4. PGFD Resistor Selection

PGFD RESISTOR	PGOOD DELAY
0 Ω	200 μ s
28k Ω	400 μ s
46.4k Ω	800 μ s
64.9k Ω	1.6ms
84.5k Ω	3.2ms
113k Ω	6.4ms
Open or short to V _{IN}	25.6ms

Address Selection (ASEL pin)

The LTC3815 slave address is selected by the ASEL pin. The upper four bits of the address are hardwired internally to 0100 and the lower three bits are programmed by a resistor connected between the ASEL and SGND (see Table 5). This allows up to 7 different LTC3815's on a single board. The LTC3815 will also respond to the Global Address 0x5A and the 7-bit address stored in the MFR_RAIL_ADDRESS register.

The ASEL pin is sampled only at power on and at initialization after the rising edge of RUN_MSTR, RUN_STBY or OPERATION register ON bit. Changes to ASEL will not take affect until one of these events occur.

Table 5. ASEL Resistor Selection

ASEL RESISTOR	SLAVE ADDRESS
0 Ω	0100000
28k Ω	0100001
46.4k Ω	0100010
64.9k Ω	0100011
84.5k Ω	0100100
102k Ω	0100101
Open or short to V _{IN}	0100111

Margining/C_{SLEW} Selection/Margin Pin

Writing to the MFR_VOUT_COMMAND register via the PMBus allows the adjustment of the V_{OUT} reference up to $\pm 25\%$ around the voltage at the REF pin. This voltage can be adjusted in 0.1% increments by writing the appropriate 9-bit two's complement value to the register. The MFR_VOUT_MARGIN_HIGH and MFR_VOUT_MARGIN_LOW register can also be used to adjust the V_{OUT} reference value by selecting the desired register with the MARGIN pin or the OPERATION command as specified in Table 6.

Table 6. V_{OUT} Margining with the MARGIN Pin and OPERATION Command

MARGIN PIN	OPERATION BITS [5:4]		V _{OUT} REFERENCE
	BIT 5	BIT 4	
<0.4V	X	X	= [1 + MFR_VOUT_MARGIN_LOW(%)] • V _{REF}
>1.2V	X	X	= [1 + MFR_VOUT_MARGIN_HIGH(%)] • V _{REF}
Hi-Z	0	0	= [1 + MFR_VOUT_COMMAND(%)] • V _{REF}
Hi-Z	0	1	= [1 + MFR_VOUT_MARGIN_LOW(%)] • V _{REF}
Hi-Z	1	0	= [1 + MFR_VOUT_MARGIN_HIGH(%)] • V _{REF}
Hi-Z	1*	1*	= [1 + MFR_VOUT_COMMAND(%)] • V _{REF}

* Setting both bits 4 and 5 high at the same time is illegal and will be ignored.

Pre-loading the registers and using the MARGIN pin provides fast margining by eliminating the latency inherent to serial bus communication. Once the registers are loaded the output voltage change is limited only by the loop bandwidth and the slew rate capacitor (C_{SLEW}).

The C_{SLEW} pin provides slew rate limiting during reference voltage changes. When the reference is changed by either the MARGIN pin, OPERATION command, or writing new values to the register, the LTC3815 counts up or down from the current value in the register to the new value at 0.1% per step. The step duration is set by the C_{SLEW} capacitor. The slew rate during the transition is thus:

$$SR = \frac{0.1}{C_{SLEW} (nF) + 0.0043} \% / ms$$

If the C_{SLEW} pin is left open, SR defaults to 23%/ms. The slew rate limit can be disabled if desired by tying the C_{SLEW} pin to V_{IN}. When disabled, the reference is immediately stepped from old value to new value in <100ns.

APPLICATIONS INFORMATION

Soft-Start

After the LTC3815 is turned on or power applied and finishes its ~500 μ s initialization sequence, the chip enters a soft start-up state. The type of soft startup behavior is set by the TRACK/SS pin:

1. Tying TRACK/SS to V_{IN} selects the internal soft-start circuit. This circuit ramps the output voltage to the final value within 1ms.
2. If a longer soft-start period is desired, it can be set externally with a capacitor on the TRACK/SS pin as shown in Figure 10. The TRACK/SS pin reduces the value of the internal reference at FB until TRACK/SS charges above the REF pin voltage. The external soft-start duration can be calculated by using the following formula:

$$t_{SS} = \frac{V_{REF} \cdot C_{SS}}{5\mu A}$$

3. The TRACK/SS pin can be used to track the output voltage of another supply.

Regardless of either internal or external soft-start state, the MODE pin is ignored and soft-start will always be in discontinuous mode until SS voltage reaches the programmed V_{OUT} reference voltage for the first time.

TRACKING

Using the TRACK/SS or the REF pin, two types of tracking/sequencing can be used for the LTC3815 (see Figure 12). For ratiometric tracking, V_{OUT} will always track a ratio of the input tracking voltage. In coincident tracking, V_{OUT} will track a ratio of the input tracking voltage until $V_{OUT} \geq V_{REF}$, then V_{OUT} is regulated to V_{REF} . Also, with ratiometric tracking, the V_{OUT} can be adjusted with the margin commands and MARGIN pin relative to the tracking voltage. With coincident tracking, V_{OUT} can only be adjusted relative to V_{REF} when $V_{MASTER} \geq V_{REF}$.

For coincident tracking, be aware that the PGOOD window is always centered around the DAC adjusted REF pin voltage, not the TRACK/SS pin voltage.

Ratiometric Tracking

To implement ratiometric tracking (Figure 13a and Figure 13b) the controlling voltage, V_{MASTER} is connected to the REF pin. This source must be able to sink the 100 μ A I_{REF} current. Using the REF pin allows V_{OUT} to be adjusted with the margining commands and MARGIN pin. For $V_{MASTER} > V_{SLAVE}$ connect V_{MASTER} to the REF pin thru a resistive divider. The relationship of V_{MASTER} to V_{SLAVE} is:

$$V_{MASTER} = V_{SLAVE} \cdot \left(1 + \frac{R1}{R2}\right) - R1 \cdot 100\mu A$$

Note that the 100 μ A I_{REF} current requires $V_{MASTER} > R1 \cdot 100\mu A$ before V_{SLAVE} starts rising above 0V. Choose a low value for R1 to minimize this offset.

For $V_{MASTER} < V_{SLAVE}$ connect V_{MASTER} directly to REF pin. The ratio of V_{MASTER} to V_{SLAVE} is now:

$$\frac{V_{MASTER}}{V_{SLAVE}} = \frac{R1}{R1 + R2}$$

Coincident Tracking

To implement coincident tracking with $V_{MASTER} \geq V_{SLAVE}$ (Figure 13c) connect V_{MASTER} to the TRACK/SS pin directly or with a resistive divider:

$$\frac{V_{MASTER}}{V_{SLAVE}} = \frac{R1}{R1 + R2}$$

V_{OUT} will follow V_{MASTER} (or a ratio of it as set by R1/R2) until $V_{MASTER} > V_{REF}$ at which time V_{OUT} is regulated to V_{REF} .

DDR Mode

The LTC3815 can both sink and source current if the MODE/SYNC pin is set to forced continuous mode. Current sinking is limited to $-6A + \Delta I_L / 2$. An external reference voltage connected to the REF pin can be used to set the output voltage. The output voltage can be margined by $\pm 25\%$ in the same way as a resistor programmed reference.

APPLICATIONS INFORMATION

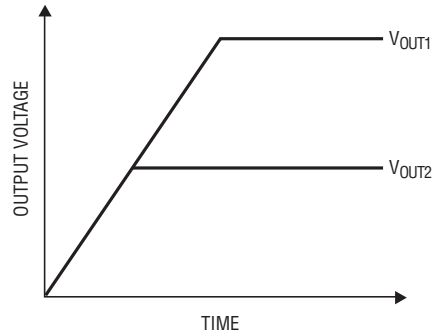

(12a) Coincident Tracking

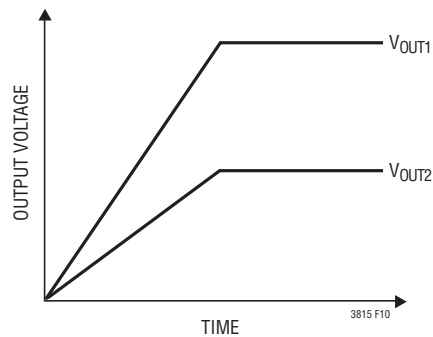

(12b) Ratiometric Tracking

Figure 12. Two Different Modes of Output Voltage Tracking

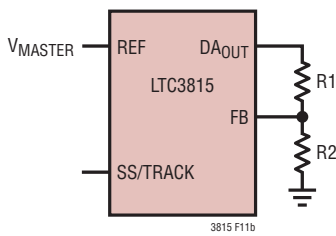

Figure 13a. Slave IC Circuit for Ratiometric Tracking and $V_{MASTER} \leq V_{SLAVE}$

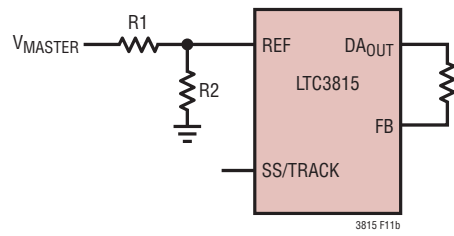

Figure 13b. Slave IC Circuit for Ratiometric Tracking and $V_{MASTER} \geq V_{SLAVE}$

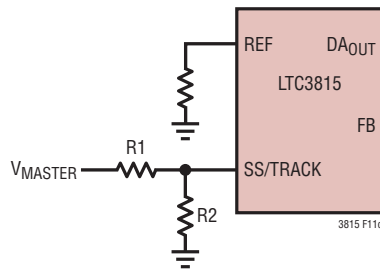

Figure 13c. Slave IC Circuit for Coincident Tracking and $V_{MASTER} \geq V_{SLAVE}$

Figure 13. Slave IC Circuits

APPLICATIONS INFORMATION

Efficiency Considerations

The efficiency of a switching regulator is equal to the output power divided by the input power times 100%. It is often useful to analyze individual losses to determine what is limiting the efficiency and which change would produce the most improvement. Efficiency can be expressed as:

$$\text{Efficiency} = 100\% - (L1 + L2 + L3 + \dots)$$

where L1, L2, etc. are the individual losses as a percentage of input power.

Although all dissipative elements in the circuit produce losses, two main sources usually account for most of the losses: V_{IN} quiescent current and I^2R losses. The V_{IN} quiescent current loss dominates the efficiency loss at very low load currents whereas the I^2R loss dominates the efficiency loss at medium to high load currents. In a typical efficiency plot, the efficiency curve at very low load currents can be misleading since the actual power lost is usually of no consequence.

1. The V_{IN} quiescent current is due to two components: the DC bias current as given in the Electrical Characteristics and the internal main switch and synchronous switch gate charge currents. The gate charge current results from switching the gate capacitance of the internal power MOSFET switches. Each time the gate is switched from low to high to low again, a packet of charge dQ moves from V_{IN} to ground. The resulting dQ/dt is the current out of V_{IN} due to gate charge, and it is typically larger than the DC bias current. Both the DC bias and gate charge losses are proportional to V_{IN} ; thus, their effects will be more pronounced at higher supply voltages.
2. I^2R losses are calculated from the resistances of the internal switches, R_{SW} , and external inductor, R_L . In continuous mode the average output current flowing through inductor L is chopped between the main switch and the synchronous switch. Thus, the series resistance looking into the SW pin is a function of both top and bottom MOSFET $R_{DS(ON)}$ and the duty cycle (DC) as follows:

$$R_{SW} = (R_{DS(ON)TOP})(DC) + (R_{DS(ON)BOT})(1 - DC)$$

The $R_{DS(ON)}$ for both the top and bottom MOSFETs can be obtained from the Typical Performance Characteristics curves. To obtain I^2R losses, simply add R_{SW} to R_L and multiply the result by the square of the average output current.

Other losses including C_{IN} and C_{OUT} ESR dissipative losses and inductor core losses generally account for less than 2% of the total loss.

Thermal Considerations

In most applications, the LTC3815 does not dissipate much heat due to its high efficiency.

However, in applications where the LTC3815 is running at high ambient temperature with low supply voltage and high duty cycles, such as in dropout, the heat dissipated may exceed the maximum junction temperature of the part. If the junction temperature reaches approximately 160°C, both power switches will be turned off and the SW node will become high impedance.

To prevent the LTC3815 from exceeding the maximum junction temperature, some thermal analysis is required. The temperature rise is given by:

$$T_{RISE} = (P_D)(\theta_{JA})$$

where P_D is the power dissipated by the regulator and θ_{JA} is the thermal resistance from the junction of the die to the ambient temperature. The junction temperature, T_J , is given by:

$$T_J = T_A + T_{RISE}$$

where T_A is the ambient temperature.

As an example, consider the case when the LTC3815 is in dropout at an input voltage of 3.3V with a load current of 6A at an ambient temperature of 70°C. From the Typical Performance Characteristics graph of Switch Resistance, the $R_{DS(ON)}$ resistance of the P-channel switch is 0.035Ω. Therefore, power dissipated by the part is:

$$P_D = (I_{OUT})^2 \cdot R_{DS(ON)} = 1.26W$$

For the QFN package, the θ_{JA} is 38°C/W.

APPLICATIONS INFORMATION

Therefore, the junction temperature of the regulator operating at 70°C ambient temperature is approximately:

$$T_J = 1.26W \cdot 38^\circ\text{C/W} + 70^\circ\text{C} = 118^\circ\text{C}$$

We can safely assume that the actual junction temperature will not exceed the absolute maximum junction temperature of 125°C. The actual die temperature can be verified with the READ_TEMPERATURE_1 command after the power supply is built and operating.

Note that for very low input voltage, the junction temperature will be higher due to increased switch resistance, $R_{DS(ON)}$. It is not recommended to use full load current for high ambient temperature and low input voltage.

To maximize the thermal performance of the LTC3815 the exposed pad should be soldered to a ground plane. See the PCB Layout Board Checklist.

2-Phase Operation

Using two LTC3815's as a 2-phase regulator to supply 12A loads was discussed on Page 16. A few more details need to be brought to the user's attention to ensure correct operation:

1) PMBus connection and READ_IIN/IOUT: Although the 2-phase regulator will operate fine with the PMBus interface connected to the master only, the READ_IOUT and READ_IIN measured values will only be available for the phase(s) that are connected. Since each phase's LTC3815 supplies half the load in a 2-phase converter, the value read (if from the master only) needs to be

doubled to obtain the total I_{OUT} or I_{IN} value. Because of slight differences in tracking between phases due to IC and inductor tolerances, a more accurate reading will be obtained by connecting to both phases so that total I_{OUT} and I_{IN} can be computed by summing each phase's contribution.

- 2) Slave PGOOD/ALERT status and margining: When the master and slave are monitoring the same output, it is sufficient to monitor the master's PGOOD and ALERT pins only. The PGOOD/ALERT pins from both master and slave can also be wire OR'ed if desired. However, if the output voltage is margined with the PMBus interface, the PGOOD/ALERT status of the slave will only be valid if the slave knows what the new margined reference is, i.e. the margin change needs to be sent to both the master and the slave. This can be done easily by using the MFR_RAIL_ADDRESS to assign the same rail address to both the master and slave so that the margin change can be done with a single write. Be aware that PMBus reads from a common address need to be done separately to avoid bus contentions.
- 3) Using the Master's CLKOUT: The CLKOUT pin provides an 180° out-of-phase clock that can be connected to the slaves MODE/SYNC pin as a simple way to run the phases out-of-phase with each other. However, be aware that the master's CLKOUT pin only provides this out-of-phase clock when the master is using its internal oscillator programmed from the RT pin. If the master is externally clocked, the slave's anti-phase clock will need to be obtained from another source.

APPLICATIONS INFORMATION

Design Example

As a design example, consider using the LTC3815 in an application with the following specifications:

$$V_{IN} = 2.25V \text{ to } 5.5V, V_{OUT} = 1.8V, I_{OUT(MAX)} = 6A, I_{OUT(MIN)} = 200mA, f = 2MHz.$$

Efficiency is important at both high and low load current, so discontinuous operation will be utilized.

First, calculate the timing resistor:

$$R_T = \frac{1.15 \cdot 10^{11} Hz}{(2 \cdot 10^6)^{1.11}} = 11.7k$$

Next, calculate the inductor value for about 30% ripple current at maximum V_{IN} :

$$L = \left(\frac{1.8V}{2MHz \cdot 2A} \right) \cdot \left(1 - \frac{1.8V}{5.5V} \right) = 0.303\mu H$$

Using a standard value of 0.3 μ H inductor results in a maximum ripple current of:

$$\Delta I_L = \left(\frac{1.8V}{2MHz \cdot 0.3\mu H} \right) \cdot \left(1 - \frac{1.8V}{5.5V} \right) = 2.02A$$

C_{OUT} will be selected based on the ESR that is required to satisfy the output voltage ripple requirement and the bulk capacitance needed for loop stability. For this design, a 150 μ F (or 47 μ F plus 100 μ F) ceramic capacitor is used with a X5R or X7R dielectric.

Assuming worst-case conditions of $V_{IN} = 2V_{OUT}$, C_{IN} should be selected for a maximum current rating of:

$$I_{RMS} = 6A \cdot \frac{1.8V}{3.6V} \cdot \sqrt{\left(\frac{3.6V}{1.8V} - 1 \right)} = 3A_{RMS}$$

Decoupling PV_{IN} with four 22 μ F capacitors is adequate for most applications.

The value of R_{REF} can now be determined by solving the following equation.

$$R_{REF} = \frac{1.8V}{100\mu A} = 18k$$

A value of 18k, 0.5% will be selected for R_{REF} .

Finally, define the soft start-up time choosing the proper value for the capacitor and the resistor connected to TRACK/SS. If we set minimum $t_{SS} = 5ms$, the following equation can be solved:

$$C_{SS} = \frac{5\mu A \cdot 5ms}{1.8V} = 13.9nF$$

The standard value of 15nF guarantees the minimum soft-start up time of 5ms.

Figure 10 shows the schematic for this design example.

PC Board Layout Checklist

When laying out the printed circuit board, the following checklist should be used to ensure proper operation of the LTC3815:

1. A ground plane is recommended. If a ground plane layer is not used, the signal and power grounds should be segregated with all small-signal components returning to the SGND pin at one point which is then connected to the PGND pin close to the LTC3815.
2. Connect the (+) terminal of the input capacitor(s), C_{IN} , as close as possible to the PV_{IN} pin, and the (-) terminal as close as possible to the exposed pad, PGND. This capacitor provides the AC current into the internal power MOSFETs.
3. Keep the switching node, SW, away from all sensitive small-signal nodes.
4. Flood all unused areas on all layers with copper. Flooding with copper will reduce the temperature rise of power components. Connect the copper areas to PGND (exposed pad) for best performance
5. Connect the remote sense pins, V_{CC_SENSE} and V_{SS_SENSE} , directly to the point where maximum V_{OUT} accuracy is desired. The two traces should be routed as close together as possible.

APPLICATIONS INFORMATION

CONNECTING THE USB TO THE I²C/SMBus/PMBus CONTROLLER TO THE LTC3815 IN SYSTEM

The LTC USB to I²C/SMBus/PMBus controller can be interfaced to the LTC3815 on the user's board for programming, telemetry and system debug. The controller, when used in conjunction with LTpowerPlay™, provides a powerful way to debug an entire power system.

Figure 14 illustrates the application schematic for powering, programming and communication with one or more LTC3815s via the LTC I²C/SMBus/PMBus controller regardless of whether or not system power is present. If

system power is not present, the LTC3815 can be powered directly from the DC1613's 3.3V supply. Since the current sourcing ability of this 3.3V supply is limited, the LTC3815 should be lightly loaded (<10mA) and operating in discontinuous mode (MODE/SYNC tied to 3.3V).

In addition any device sharing the I²C bus connections with the LTC3815 should not have body diodes between the SDA/SCL pins and their respective V_{DD} node because this will interfere with bus communication in the absence of system power.

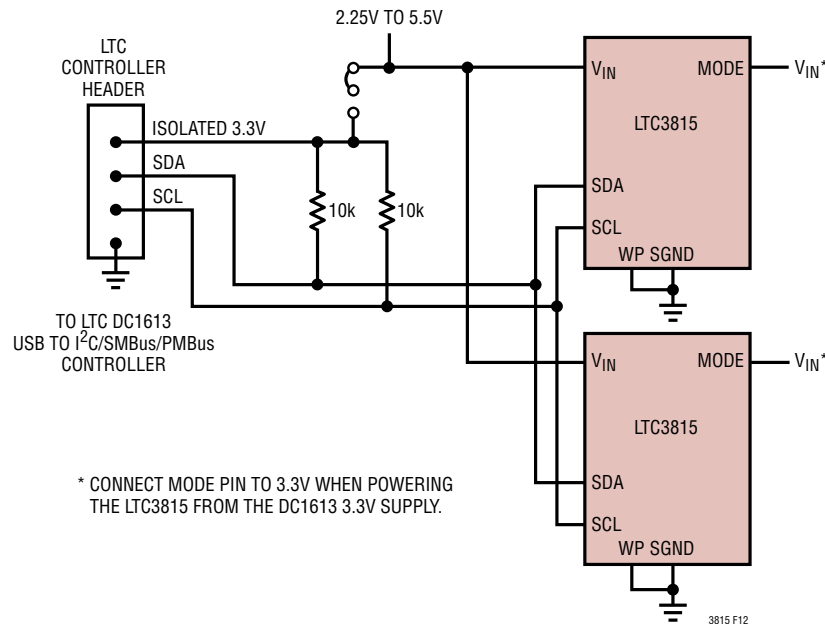

Figure 14. LTC Controller Connection

APPLICATIONS INFORMATION

LTpowerPlay: AN INTERACTIVE GUI FOR DIGITAL POWER

LTpowerPlay is a powerful Windows-based development environment that supports Linear Technology power system management ICs including the LTC3815. The software supports a variety of different tasks. LTpowerPlay can be used to evaluate Linear Technology ICs by connecting to a demo board or the user application. LTpowerPlay can also be used in an offline mode (with no hardware present) in order to build multiple IC configuration files that can be saved and reloaded at a later time. LTpowerPlay provides unprecedented diagnostic and debug features. It becomes a valuable diagnostic tool during board bring-up to program or tweak the power system or to diagnose

power issues when bring up rails. LTpowerPlay utilizes Linear Technology's USB-to-I²C/SMBus/PMBus controller to communication with one of the many potential targets including the DC1590B-A/DC1590B-B demo board, the DC1709A socketed programming board, or a customer target system. The software also provides an automatic update feature to keep the revisions current with the latest set of device drivers and documentation. A great deal of context sensitive help is available with LTpowerPlay along with several tutorial demos. Complete information is available at <http://www.linear.com/ltpowerplay>.

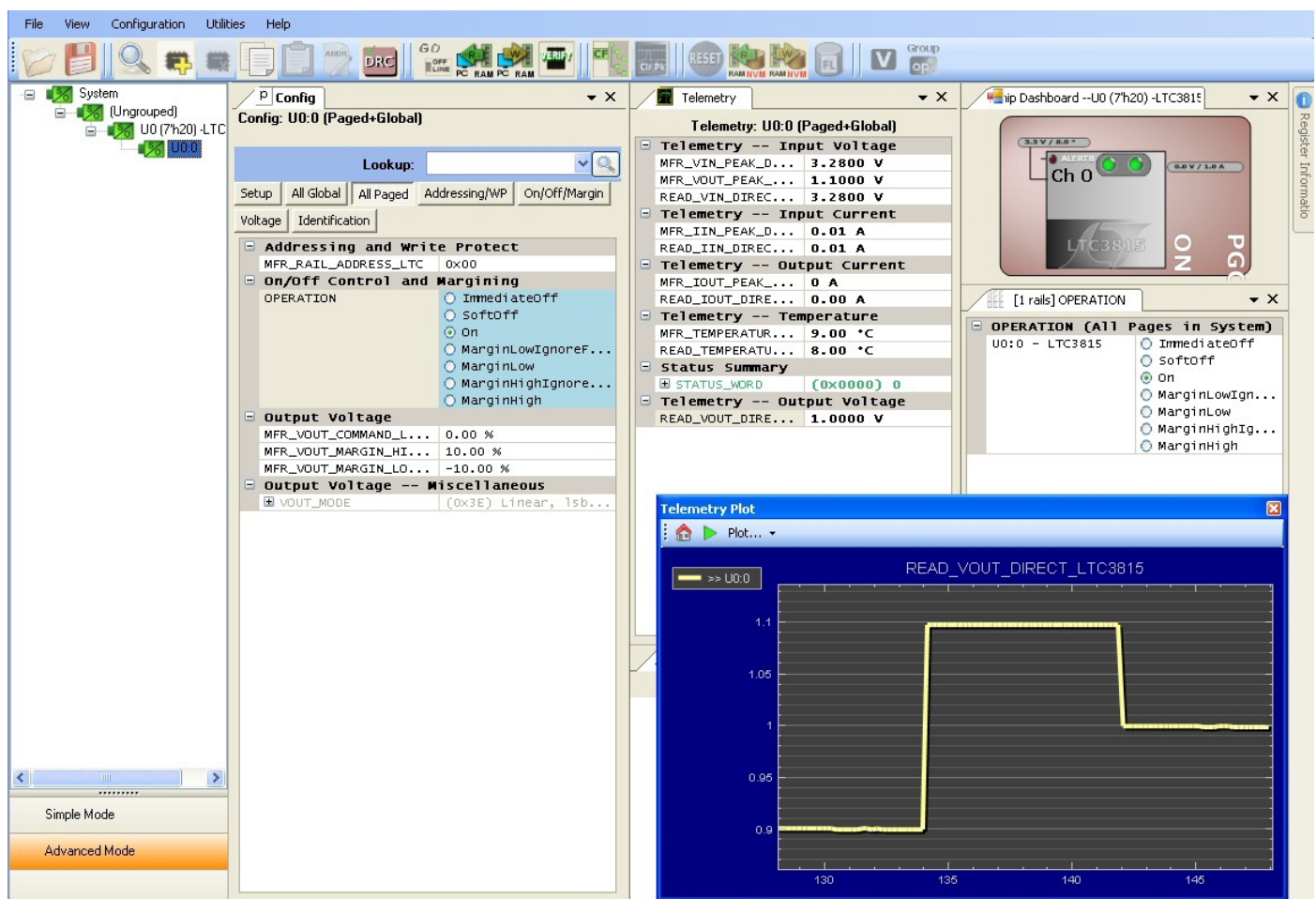

Figure 15. LTpowerPlay

PMBus COMMAND DETAILS

MFR_RESET

This command provides a means by which the user can perform a reset of the LTC3815. All latched faults ($\overline{\text{ALERT}}$ and status register) and register (telemetry, margin, etc) contents will be reset to a power-on condition by this command. V_{OUT} will remain in regulation but may change due to the reset of the margin registers. ASEL and PGFD config resistors are re-measured.

This write-only command accepts zero, one, or two data bytes but ignores them.

MFR_RAIL_ADDRESS

The MFR_RAIL_ADDRESS command allows all devices to share a common address, such as all devices attached to a single power supply rail. The desired 7-bit address value is written to the 7 bits of the data byte.

The MSB (bit B7) must be set low to enable communication using the MFR_RAIL_ADDRESS address. Setting this bit disables this address.

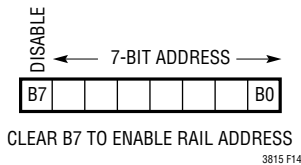

Figure 16. MFR_RAIL_ADDRESS Data Byte

The user should only perform command writes to this address. If a read is performed from this address and the rail devices do not respond with EXACTLY the same value, the LTC3815 will detect bus contention and set a CML communications fault.

This command accepts one or two data bytes but the second is ignored.

OPERATION

The OPERATION command is used to turn the unit on/off and for margining the output voltage.

The ON bit has the same function as the RUN_STBY pin, i.e. clearing it turns off the output voltage with PMBus interface still active and telemetry data refreshed at a slower

1Hz rate to minimize supply current. Either RUN_STBY pin or ON bit can be cleared/deasserted to put the LTC3815 into this standby mode. The ON bit is automatically reset to ON after a master shutdown ($\text{RUN_MSTR} = 0\text{V}$), power cycle, or MFR_RESET command.

The MARGIN_LOW/HIGH bits command the V_{OUT} reference to the offset value stored in either the MFR_VOUT_MARGIN_HIGH or MFR_VOUT_MARGIN_LOW, resp. at the slew rate set by the C_{SLEW} capacitor. These bits are identical in function to margin high/low from the MARGIN pin. However, the MARGIN pin has precedence over the MARGIN_LOW/HIGH bits when there is a conflict. Cycling the RUN_STBY pin has no effect on the margin bits and thus when re-asserting RUN_STBY, V_{OUT} will return to the state it was in prior to the shutdown.

Margin high (ignore faults) and margin low (ignore faults) operations are not supported by the LTC3815.

This command has one data byte. It will accept one or two but ignore the second byte.

Table 7. Supported OPERATION Command Register Values

ACTION	VALUE
Turn off immediately	0x00
Turn on	0x80
Margin Low	0x98
Margin High	0xA8

VOUT_MODE

VOUT_MODE command specifies the formatting for reading output voltage. The data byte always reads 0x3E for VID data format and cannot be changed. Attempts to write to VOUT_MODE will set a CML fault.

This read-only command has one data byte.

MFR_VOUT_COMMAND

The MFR_VOUT_COMMAND consists of a value (%) used to offset the output reference voltage at the REF pin. The C_{SLEW} capacitor sets the slew rate limit of the output voltage if this command is modified while the output is active and in a steady-state condition.

PMBus COMMAND DETAILS

This command has two data bytes and is formatted as a 9-bit 2's complement number with 0.1%/bit scaling.

The range of MFR_VOUT_COMMAND value is limited to $\pm 25\%$.

Do not attempt to write values outside of this range or unpredictable behavior may result. Writes to this register are inhibited when the WP pin is high.

MFR_VOUT_MARGIN_LOW

The MFR_VOUT_MARGIN_LOW command loads the LTC3815 with the value to which the output is changed, in percent, when the OPERATION command is set to margin low or the fast margining pin, MARGIN, is pulled below 0.4V. Slew rate limiting is same as MFR_VOUT_COMMAND.

This command has two data bytes and is formatted as a 9-bit 2's complement number with 0.1%/bit scaling.

The range of MFR_VOUT_MARGIN_LOW value is limited to $\pm 25\%$. There is no restriction on the value relative to VOUT_COMMAND and MFR_VOUT_MARGIN_HIGH, i.e. the value is not required to be lower.

Do not attempt to write values outside of this range or unpredictable behavior may result. Writes to this register are inhibited when the WP pin is high.

MFR_VOUT_MARGIN_HIGH

The MFR_VOUT_MARGIN_HIGH command loads the LTC3815 with the value to which the output is changed, in percent, when the OPERATION command is set to margin high or the fast margining pin, MARGIN, is pulled above 1.1V. Slew rate limiting is same as MFR_VOUT_COMMAND.

This command has two data bytes and is formatted as a 9-bit 2's complement number with 0.1%/bit scaling.

The range of MFR_VOUT_MARGIN_HIGH value is limited to $\pm 25\%$. There is no restriction on the value relative to MFR_VOUT_COMMAND and MFR_VOUT_MARGIN_LOW, i.e. the value is not required to be higher.

Do not attempt to write values outside of this range or unpredictable behavior may result. Writes to this register are inhibited when the WP pin is high.

PMBus_REVISION

The PMBUS_REVISION command indicates the revision of the PMBus to which the device is compliant. The LTC3815 is PMBus Version 1.2 compliant in both Part I and Part II.

This read-only command has one data byte.

MFR_SPECIAL_ID

The 16-bit word representing the part name and revision. The MSB equals 0x80 and denotes the part is an LTC3815. The LSB is adjustable by the manufacturer.

This read-only command has 2 data bytes.

MFR_CLEAR_PEAKS

The MFR_CLEAR_PEAKS command clears the MFR_*_PEAK data values and restarts the peak monitor routine.

This write-only command requires no data bytes, but will accept (and ignore) up to two.

STATUS_WORD

The STATUS_WORD command returns two bytes of information with a summary of the unit's fault condition.

See Table 8 for a list of the status bits that are supported and the conditions in which each bit is set. Certain bits when set in the STATUS_WORD also cause the $\overline{\text{ALERT}}$ pin to be asserted.

Writing a "1" to a particular bit in the status word will attempt to reset that fault in the status word and the $\overline{\text{ALERT}}$ pin. If the fault is still present the status word bit and $\overline{\text{ALERT}}$ will remain asserted. If the $\overline{\text{ALERT}}$ has previously been cleared by an ARA message, the $\overline{\text{ALERT}}$ will be re-asserted. If the fault is no longer present, the $\overline{\text{ALERT}}$ pin will be de-asserted and the fault bit in the status word will be cleared.

All bits in the status word are also cleared by toggling the RUN_MSTR pin or the ON bit in OPERATION. The bit will immediately be set again if the fault remains.

This command has two data bytes.

PMBus COMMAND DETAILS

Table 8. Status Word Bit Descriptions and Conditions

BIT	DESCRIPTION	CONDITION	SET ALERT?	CLEARABLE BY WRITING '1' TO BIT?
0 (LSB)	None of the Above	If b[15] set due to V_{OUT} undervoltage	Yes	No
1	Communication Failure	(See Note 1)	Yes	Yes
2	Temperature Fault	Temp > 150°C	Yes	Yes
3	V_{IN} Undervoltage Fault	Not Implemented		
4	Output Overcurrent Fault	Not Implemented		
5	Output Overvoltage Fault	V_{OUT} > PGOOD High Threshold	Yes	Yes
6	OFF	No Power to the Output (Note 2)	No	No
7	Busy	Not Implemented		
8	Unknown	Not Implemented		
9	Other	Not Implemented		
10	Fans	Not Implemented		
11	PGOOD	Inverted state of PGOOD pin	No	No
12	Manufacturer Specific	Not Implemented		
13	Input Voltage/ Current/Power Fault	Not Implemented	Yes	Yes
14	Output Current/Power Fault	Not Implemented		
15 (MSB)	Output Voltage Fault	V_{OUT} outside PGOOD window (Note 3)	Yes	Yes

Note 1: Communication failure is one of following faults: host sends too few bits, host reads too few bits, host writes too few bytes, host reads too many bytes, improper R/W bit set, unsupported command code, attempt to write to a read-only command. See PMBus Specification v1.2, Part II, Sections 10.8 and 10.9 for more information.

Note 2: Power may be off due to any one of the following conditions: RUN_STBY low, OPERATION ON cleared, PV_{IN} undervoltage or

overtemperature warning. When the power is off due to RUN_MSTR low or due to a more serious fault conditions such as V_{IN} low or overtemperature fault, the PMBus interface is turned off instead of asserting the OFF bit.

Note 3: This bit is disabled when drivers are off for any reason, soft-start not complete, or the V_{OUT} has not reached the PGOOD window for the first time.

PMBus COMMAND DETAILS

All of the following telemetry registers are initialized to 0x8000 when cycling power, cycling RUN_MSTR pin or sending a MFS_RESET command. The register will remain at this value until its first conversion is complete—typically within 50ms of the initialization event.

READ_V_{IN}

The READ_V_{IN} command returns the measured input voltage, in volts, at the V_{IN} pin.

This read-only command has two data bytes and is formatted as a 16-bit 2's complement value scaled 4mV/bit.

READ_V_{OUT}

The READ_V_{OUT} command returns the measured output voltage, in volts as specified by the V_{OUT_MODE} command.

The output voltage is sensed at the V_{CC_SEN} and V_{SS_SEN} pins.

This read-only command has two data bytes and is formatted as a 16-bit 2's complement value scaled 0.5mV/bit.

READ_I_{IN}

The READ_I_{IN} command returns the input current in Amperes. The input current is derived from READ_I_{OUT} current and the measured duty cycle with an offset term added to account for quiescent current and driver current. For accurate values at light load currents the part must be in continuous conduction mode.

This register is reset to 0x8000 in standby mode when the drivers are off.

This read-only command has two data bytes and is formatted as a 16-bit 2's complement value scaled 10mA/bit.

READ_I_{OUT}

The READ_I_{OUT} command returns the average output current in amperes. The LTC3815 senses and measures the currents through its top and bottom power switches to derive I_{OUT} current. For accurate values at light load currents the part must be in continuous conduction mode.

This register is reset to 0x8000 in standby mode when the drivers are off.

This read-only command has two data bytes and is formatted as a 16-bit 2's complement value scaled 10mA/bit.

READ_TEMPERATURE_1

The READ_TEMPERATURE_1 command returns the internal die temperature, in degrees Celsius, of the LTC3815.

This read-only command has two data bytes and is formatted as a 16-bit 2's complement value scaled 1°C/bit.

MFR_V_{OUT}_PEAK

The MFR_V_{OUT}_PEAK command reports the highest voltage, in volts, reported by the READ_V_{OUT} measurement.

To clear the peak value and restart the peak monitor, use the MFS_CLEAR_PEAKS command or write to the MFR_V_{OUT}_PEAK. When writing to MFR_V_{OUT}_PEAK, zero, one or two data bytes are accepted but the data is ignored.

This read-only command has two data bytes and is formatted as a 16-bit 2's complement value scaled 0.5mV/bit.

MFR_V_{IN}_PEAK

The MFR_V_{IN}_PEAK command reports the highest voltage, in volts, reported by the READ_V_{IN} measurement.

To clear the peak value and restart the peak monitor, use the MFS_CLEAR_PEAKS command or write to the MFR_V_{IN}_PEAK. When writing to MFR_V_{IN}_PEAK zero, one or two data bytes are accepted but the data is ignored.

This read-only command has two data bytes and is formatted as a 16-bit 2's complement value scaled 4mV/bit.

MFR_TEMPERATURE_1_PEAK

The MFR_TEMPERATURE_1_PEAK command reports the highest temperature, in degrees Celsius, reported by the READ_TEMPERATURE_1 measurement.

To clear the peak value and restart the peak monitor, use the MFS_CLEAR_PEAKS command or write to the MFR_TEMPERATURE_1_PEAK. When writing to MFR_TEMPERATURE_1__PEAK zero, one or two data bytes are accepted but the data is ignored.

PMBus COMMAND DETAILS

This read-only command has two data bytes and is formatted as a 16-bit 2's complement value scaled 1°C/bit.

MFR_IOUT_PEAK

The MFR_IOUT_PEAK command reports the highest current, in amperes, reported by the READ_IOUT measurement.

To clear the peak value and restart the peak monitor, use the MFS_CLEAR_PEAKS command or write to the MFR_IOUT_PEAK. When writing to MFR_IOUT_PEAK, zero, one or two data bytes are accepted but the data is ignored.

This read-only command has two data bytes and is formatted as a 16-bit 2's complement value scaled 10mA/bit.

MFR_IIN_PEAK

This read-only command has two data bytes and is formatted as a 16-bit 2's complement value scaled 10mA/bit.

To clear the peak value and restart the peak monitor, use the MFS_CLEAR_PEAKS command or write to the MFR_IIN_PEAK. When writing to MFR_IIN_PEAK, zero, one or two data bytes are accepted but the data is ignored.

This read-only command has two data bytes and is formatted as a 16-bit 2's complement value scaled 10mA/bit.

TYPICAL APPLICATIONS

12V Input, 1.0V/6A Output Buck Regulator

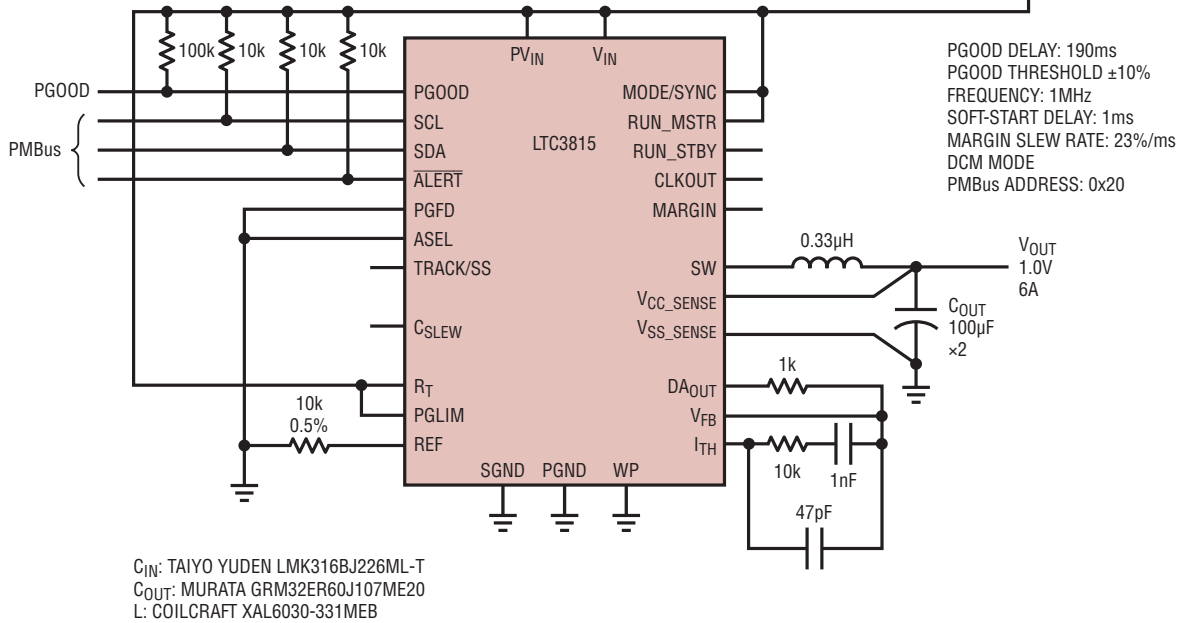
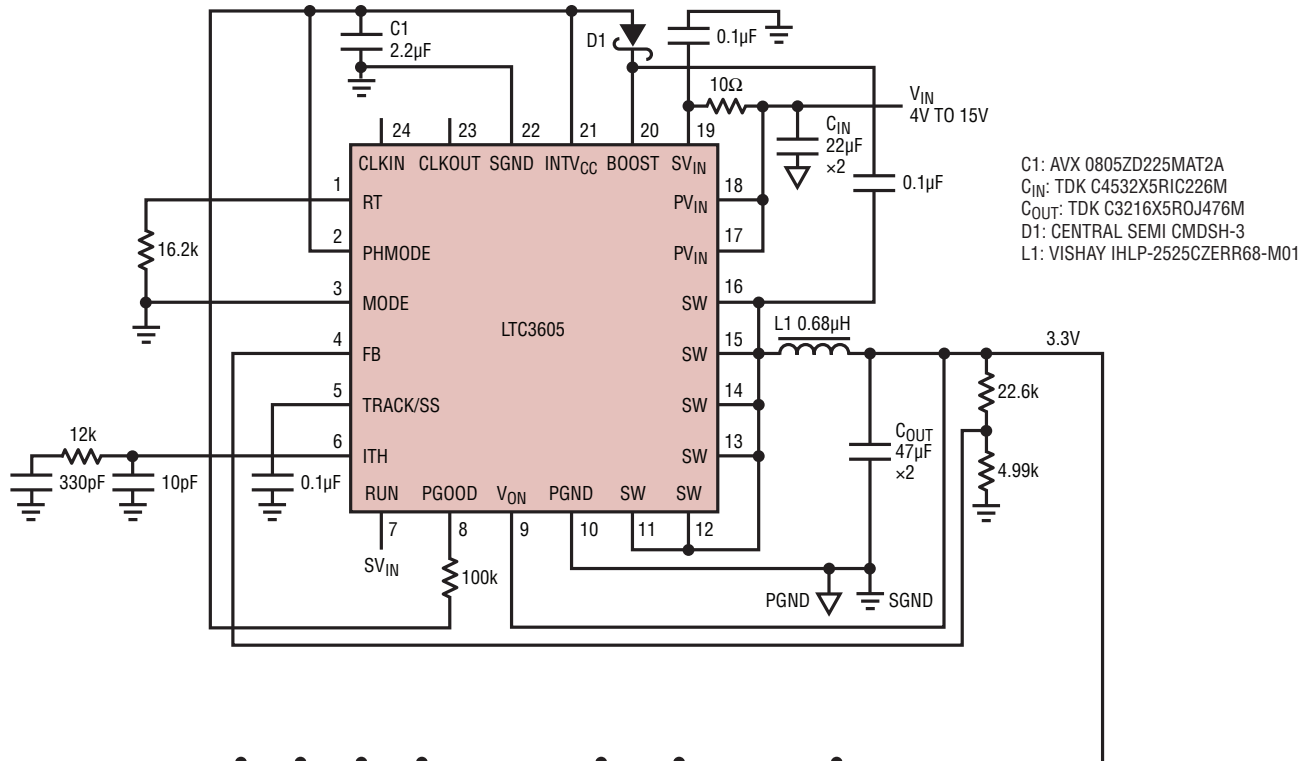

3815 TA04

PACKAGE DESCRIPTION

Please refer to <http://www.linear.com/product/LTC3815#packaging> for the most recent package drawings.

UFE Package 38-Lead Plastic QFN (4mm × 6mm) (Reference LTC DWG # 05-08-1750 Rev B)

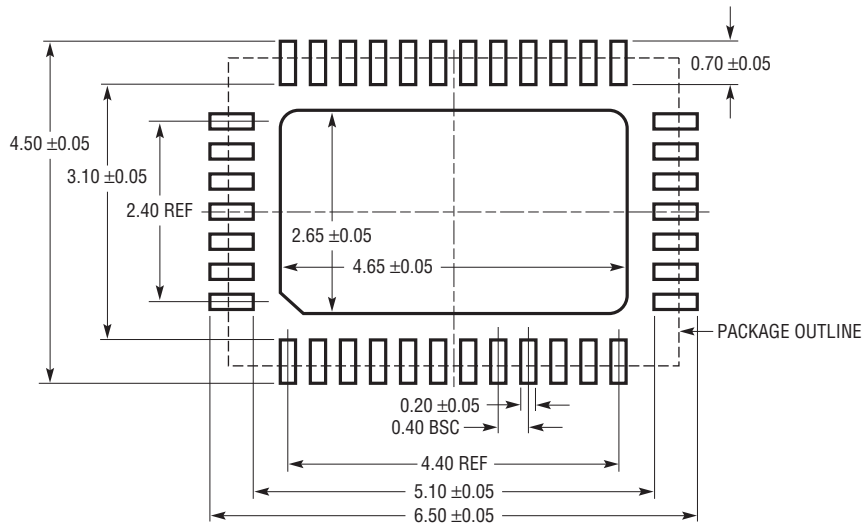

RECOMMENDED SOLDER PAD PITCH AND DIMENSIONS
APPLY SOLDER MASK TO AREAS THAT ARE NOT SOLDERED

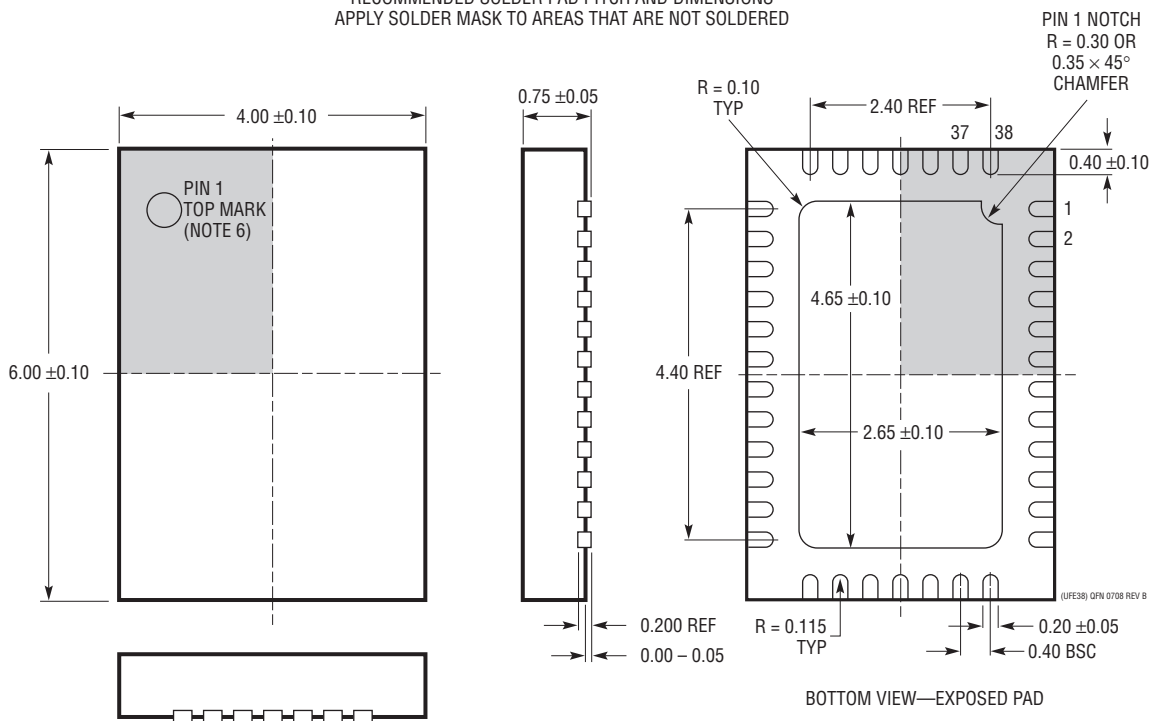

- NOTE:
1. DRAWING IS NOT A JEDEC PACKAGE OUTLINE
 2. DRAWING NOT TO SCALE
 3. ALL DIMENSIONS ARE IN MILLIMETERS
 4. DIMENSIONS OF EXPOSED PAD ON BOTTOM OF PACKAGE DO NOT INCLUDE MOLD FLASH. MOLD FLASH, IF PRESENT, SHALL NOT EXCEED 0.15mm ON ANY SIDE
 5. EXPOSED PAD SHALL BE SOLDER PLATED
 6. SHADED AREA IS ONLY A REFERENCE FOR PIN 1 LOCATION ON THE TOP AND BOTTOM OF PACKAGE

TYPICAL APPLICATION

1.2V/12A 2-Phase Buck Regulator

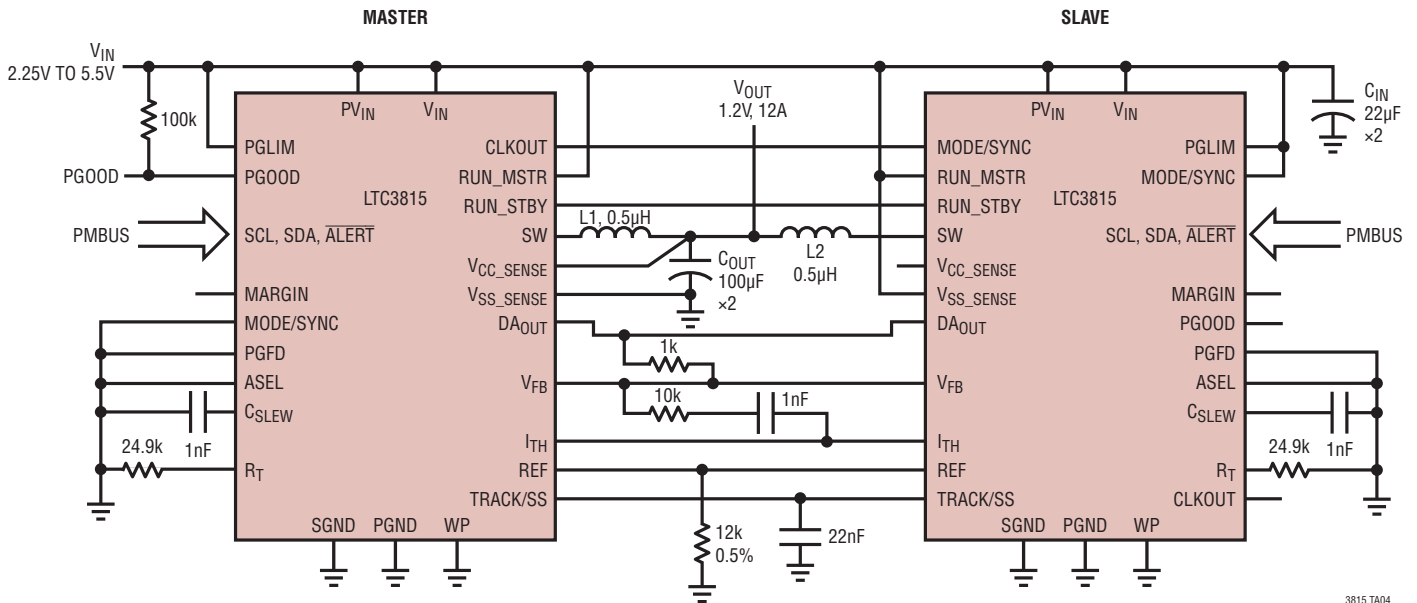

C_{IN} : TAIYO YUDEN LMK316BJ226ML-T
 C_{OUT} : MURATA GRM32ER60J107ME20
 L1, L2: COILCRAFT XAL6030-331MEB

3815 TA04

RELATED PARTS

PART NUMBER	DESCRIPTION	COMMENTS
LTM4676A	Dual 13A or Single 26A Step-Down DC/DC μ Module Regulator with Digital Power System Management	$4.5V \leq V_{IN} \leq 17V$, $0.5V \leq V_{OUT} (\pm 0.5\%) \leq 5.5V$, I ² C/PMBus Interface, 16mm x 16mm x 5mm, BGA Package
LTM4675	Dual 9A or Single 18A μ Module Regulator with Digital Power System Management	$4.5V \leq V_{IN} \leq 17V$; $0.5V \leq V_{OUT} (\pm 0.5\%) \leq 5.5V$, I ² C/PMBus Interface, 11.9mm x 16mm x 5mm, BGA Package
LTM4677	Dual 18A or Single 18A μ Module Regulator with Digital Power System Management	$4.5V \leq V_{IN} \leq 16V$; $0.5V \leq V_{OUT} (\pm 0.5\%) \leq 1.8V$, I ² C/PMBus Interface, 16mm x 16mm x 5.01mm, BGA Package
LTC3884	Dual Output Multiphase Step-Down Controller with Sub MilliOhm DCR Sensing Current Mode Control and Digital Power System Management	$4.5V \leq V_{IN} \leq 38V$, $0.5V \leq V_{OUT} (\pm 0.5\%) \leq 5.5V$, 70ms Start-Up, I ² C/PMBus Interface, Programmable Analog Loop Compensation, Input Current Sense
LTC3887/ LTC3887-1	Dual Output Multiphase Step-Down DC/DC Controller with Digital Power System Management, 70ms Start-Up	$4.5V \leq V_{IN} \leq 24V$, $0.5V \leq V_{OUT0,1} (\pm 0.5\%) \leq 5.5V$, 70ms Start-Up, I ² C/PMBus Interface, -1 Version Uses DrMOS and Power Blocks
LTC3882/ LTC3882-1	Dual Output Multiphase Step-Down DC/DC Voltage Mode Controller with Digital Power System Management	$3V \leq V_{IN} \leq 38V$, $0.5V \leq V_{OUT1,2} \leq 5.25V$, $\pm 0.5\%$ V_{OUT} Accuracy I ² C/PMBus Interface, Uses DrMOS or Power Blocks
LTC3886	60V Dual Output Step-Down Controller with Digital Power System Management	$4.5V \leq V_{IN} \leq 60V$, $0.5V \leq V_{OUT0,1} (\pm 0.5\%) \leq 13.8V$, 70ms Start-Up, I ² C/PMBus Interface, Input Current Sense
LTC3883/ LTC3883-1	Single Phase Step-Down DC/DC Controller with Digital Power System Management	V_{IN} Up to 24V, $0.5V \leq V_{OUT} \leq 5.5V$, Input Current Sense Amplifier, I ² C/PMBus Interface with EEPROM and 16-Bit ADC, $\pm 0.5\%$ V_{OUT} Accuracy
LTC3870/ LTC3870-1	60V Dual Output Multiphase Step-Down Slave Controller for Current Mode Control Applications with Digital Power System Management	V_{IN} Up to 60V, $0.5V \leq V_{OUT} \leq 14V$, Very High Output Current Applications with Accurate Current Share Between Phases Supporting LTC3880/LTC3880-1, LTC3883/LTC3883-1, LTC3886, LTC3887/LTC3887-1
LTC3874	Multiphase Step-Down Synchronous Slave Controller with Sub MilliOhm DCR Sensing	$4.5V \leq V_{IN} \leq 38V$, V_{OUT} Up to 5.5V, Very High Output Current, Accurate Current Sharing, Current Mode Applications
LTC3880/ LTC3880-1	Dual Output Multiphase Step-Down DC/DC Controller with Digital Power System Management	$4.5V \leq V_{IN} \leq 24V$, $0.5V \leq V_{OUT0} (\pm 0.5\%) \leq 5.4V$, 145ms Start-Up, I ² C/PMBus Interface with EEPROM and 16-Bit ADC

3815f

X-ON Electronics

Largest Supplier of Electrical and Electronic Components

Click to view similar products for [Switching Voltage Regulators](#) category:

Click to view products by [Linear Technology](#) manufacturer:

Other Similar products are found below :

[TLF30682QVS01XUMA1](#) [TPSM84209RKHR](#) [FAN53526UC106X](#) [FAN53526UC128X](#) [MP1587EN-LF](#) [FAN48610BUC33X](#)
[FAN48617UC50X](#) [FAN53526UC89X](#) [MIC45116-1YMP-T1](#) [NCV891234MW50R2G](#) [EN2342QI](#) [AST1S31PUR](#) [16017](#) [A6986FTR](#)
[NCP81103MNTXG](#) [NCP81203PMNTXG](#) [MAX17242ETPA+](#) [MAX16935RATEB/V+](#) [MP2313GJ-Z](#) [NCP81208MNTXG](#) [MP8759GD-Z](#)
[FAN53526UC100X](#) [FAN53526UC84X](#) [PCA9412AUKZ](#) [MP2314SGJ-Z](#) [AS1340A-BTDM-10](#) [MP3421GG-P](#) [NCP81109GMNTXG](#)
[MP6003DN-LF-Z](#) [MAX16935BAUES/V+](#) [LT8315IFE#PBF](#) [SCY1751FCCT1G](#) [NCP81109JMNTXG](#) [MAX16956AUBA/V+](#)
[AP3409ADNTR-G1](#) [FAN48623UC36FX](#) [MPQ2454GH](#) [MPQ2454GH-AEC1](#) [MP21148GQD-P](#) [AS3701B-BWLM-68](#) [MPQ2143DJ-P](#)
[MP9942AGJ-P](#) [MP8759GD-P](#) [MP5610GQG-P](#) [MP28200GG-P](#) [MP2451DJ-LF-Z](#) [MP2326GD-P](#) [MP2314SGJ-P](#) [MP2158AGQH-P](#)
[MP2148GQD-18-P](#)