

ELECTRICAL
INTERCONNECTIONS

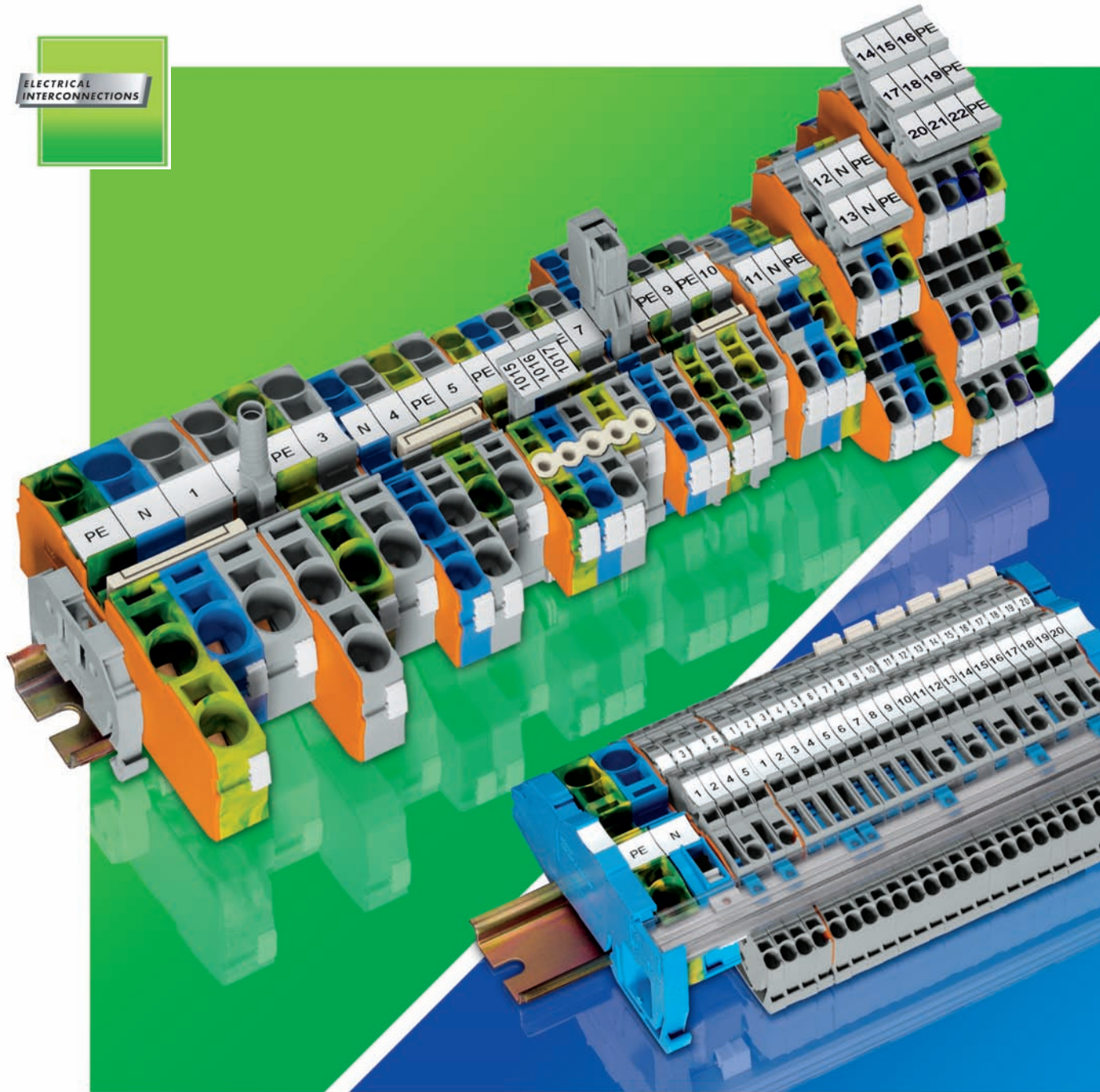

[TOPJOB[®]S]

- **The** range of rail-mounted terminal blocks for a perfect electrical installation.

WAGO[®]
INNOVATIVE CONNECTIONS



● **The** range of rail-mounted terminal blocks for a perfect electrical installation.

The new standard for rail-mounted terminal blocks	4
Wire connection	5
Commoning	6
Commoning with staggered jumpers	7
Commoning with step-down jumpers	7
Modular connectors / Testing	8
Marking	9
Product overview	10 – 15

Rail-mounted terminal blocks 1.5 (2.5) mm ² / AWG 14	16
Rail-mounted terminal blocks 2.5 (4) mm ² / AWG 12	17
Rail-mounted terminal blocks 4 (6) mm ² / AWG 10	18
Rail-mounted terminal blocks 6 (10) mm ² / AWG 8	19
Rail-mounted terminal blocks 10 (16) mm ² / AWG 6	20
Rail-mounted terminal blocks 16 (25 "f-st") mm ² / AWG 4	21
35° Rail-mounted terminal blocks 1.5 (2.5) mm ² / AWG 14	22
Test plug adapter and testing tap	23
Push-in type wire jumpers	23
Modular connectors	24 – 25
Double deck terminal blocks 2.5 (4) mm ² / AWG 12	26
Triple deck terminal blocks 2.5 (4) mm ² / AWG 12	27
Multilevel installation terminal blocks 2.5 (4) mm ² / AWG 12	28
Multilevel installation terminal blocks 6 (10) mm ² / AWG 8	29

N-disconnect terminal blocks 2.5 (4) mm ² / 6 (10) mm ² / 16 (25 "f-st") mm ²	30
Disconnect terminal blocks for test and measurement 2.5 (4) mm ² / AWG 12	31 – 32
Double deck disconnect terminal blocks for test and measurement 2.5 (4) mm ² / AWG 12	33
Double deck diode and LED terminal blocks 2.5 (4) mm ² / AWG 12	34 – 35
Triple deck diode and LED terminal blocks 2.5 (4) mm ² / AWG 12	36 – 37
Marking of terminal blocks	38 – 40
Mounting accessories and stickers for operating instructions	41
Ferrules and crimping tools	42 – 43
Examples of circuit configuration	44 – 45
Examples of installation in standard distribution boxes	46 – 47
Examples of circuit configuration with staggered jumpers	48
List of approvals	49
Index of item nos.	50 – 51

[Simply smaller]

• The new standard for rail-mounted terminal blocks

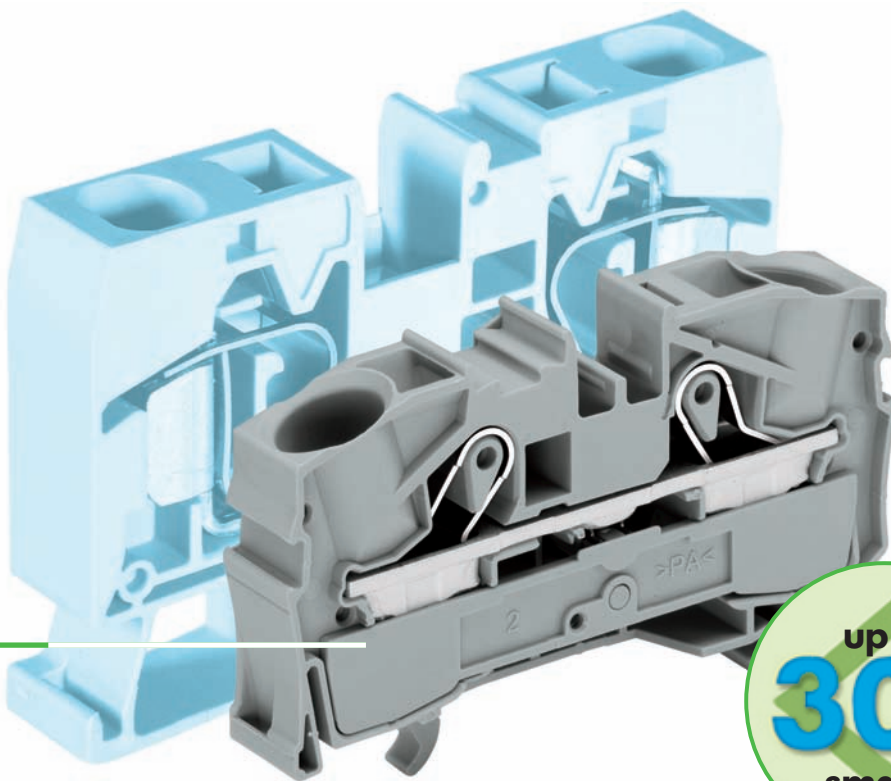

up to
30%
smaller

• TOPJOB®'S DIN 35 rail-mounted terminal blocks with CAGE CLAMP®'S technology are the smallest on the market resulting in a space saving of up to 30%.

The reduction of panel space, smaller enclosures and junction boxes are just some of the cost savings that can be realized.

Simply push-in

for solid conductors or fine-stranded conductors with ferrules



ferruled wires

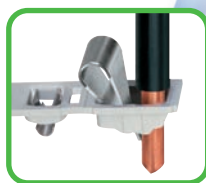

solid wires

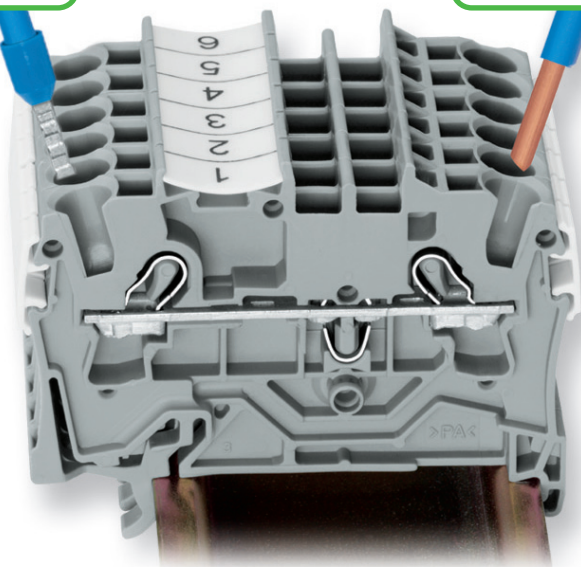

Stripped solid conductors, stranded conductors with ferrules, or ultrasonically “bonded” conductors are easily connected by simply pushing the wire into the wire entry.

For conductors rated 0.5 mm^2 (AWG 20) to 16 mm^2 (AWG 6) – **this is a significant time and cost saving!**

Wire connection – Push-in connection

Solid wires ranging from at least two sizes below to one size above the rated cross section can be pushed in directly without tools.

Stranded conductors with ferrules ranging from at least two sizes below the rated cross section up to the rated cross section can also be easily inserted without using any tools.

Wire connection using a screwdriver

Connecting stranded conductors without ferrules or small cross-sectional conductors that cannot be pushed in, is done similar to the original CAGE CLAMP®, using a screwdriver.

The smart feature

To open the clamp, the screwdriver is inserted from the vertical and the conductor entry is less than 15 degrees resulting in easier wiring.

stranded wires

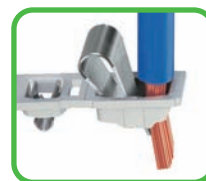

15°

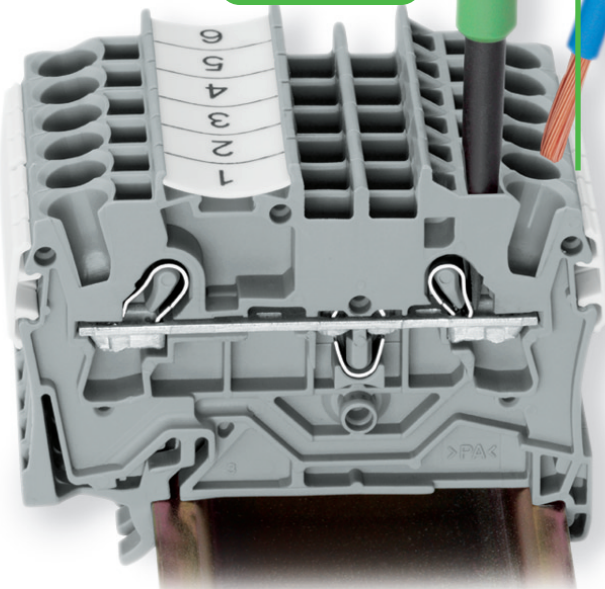

Wire removal

The conductor is removed using a screwdriver, like the original CAGE CLAMP®.

Simply jumpered

The comb-style jumper system is based on the common plug and socket principle. Each terminal block is spring loaded with a double socket and a resilient CrNi steel spring. The jumper contact is pure electrolytic copper, which allows for an extremely small design capable of carrying the full-rated current of the terminal block. Ground (earth) terminal blocks can also be commoned using the same jumper system. Alternate or staggered jumpers for terminal blocks up to 4 mm² (AWG 10) can be made in the field by simply breaking and removing jumper contacts.

The smart feature

Jumper slots can also be used for :

- push-in type jumper bars and step-down jumpers
- test plug adapters and testing taps or
- preharnessed plugs for connection of subassemblies

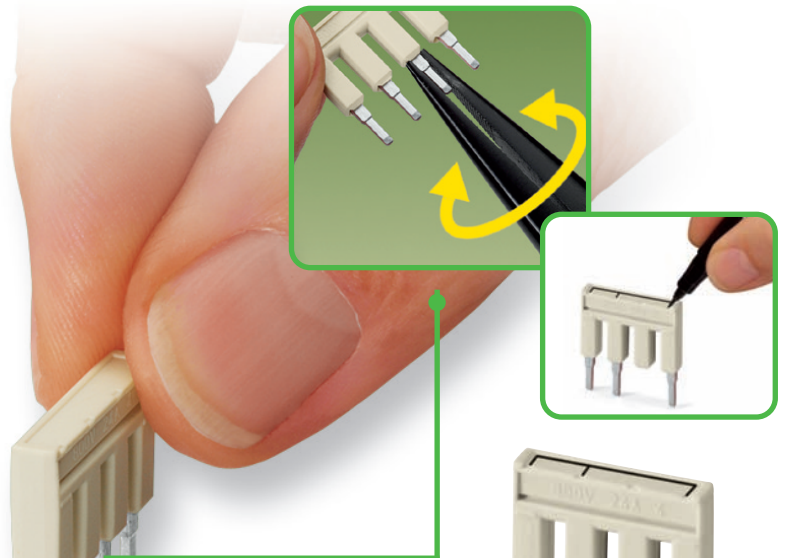
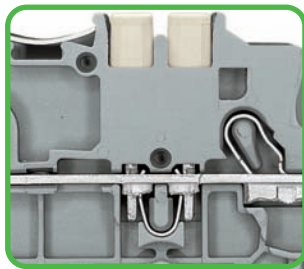

Star point jumper

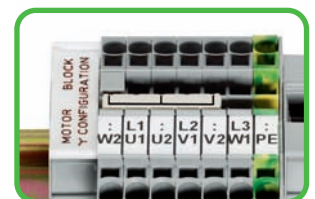
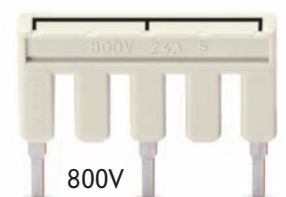

This jumper has been specially developed to create a "star point" and is used on motor terminal boards equipped with TOPJOB®S rail-mounted terminal blocks.

The star point jumper is available for the Series 2002, 2004, 2006, 2010 and 2016. Item no. upon request.

Removal of jumper

Insert the screwdriver blade between the jumper and the partition wall of the dual jumper slots and lift up the jumper.

Using jumpers with maximum 5 contacts, place the screwdriver in the center of the jumper (see ill. 3). For more than 5-way jumpers, place the screwdriver alternating at both ends of the jumper.

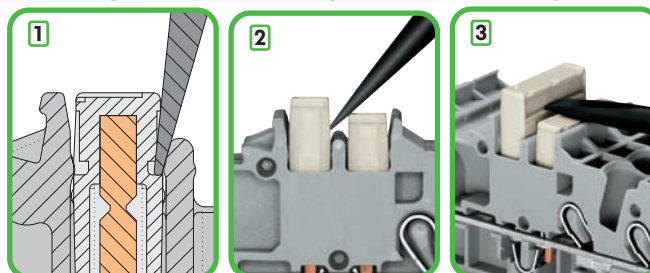

Simply commoned with staggered jumpers

The special design of the TOPJOB®S staggered jumpers allows two jumpers to be used in each jumper slot of the 2002 Series TOPJOB®S rail-mounted terminal blocks and 2003 Series multilevel installation terminal blocks. This means that four different potentials can be commoned simultaneously using rail-mounted terminal blocks with dual jumper slots.

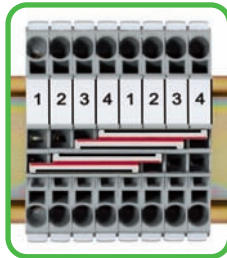

Insert the staggered jumpers so that the red lines of both jumpers are facing each other.

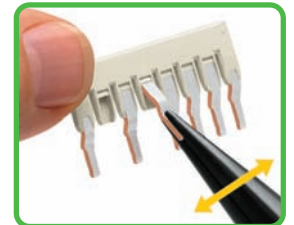
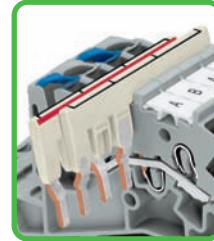

Custom staggered jumpers are created by breaking off individual jumper contacts. Make sure that only one contact lug is in contact with the terminal block. See also page 28.

Simply jumpered

with step-down jumpers

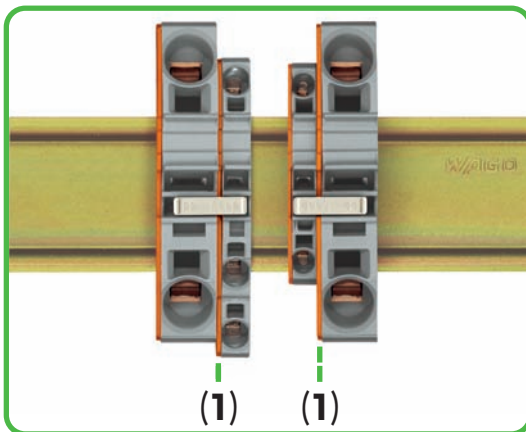

An end plate (1) must always be applied between the terminal blocks to be **commoned with step-down jumpers**.

Note

The total current flowing cannot exceed the rating of the step-down jumper or push-in type jumper bar.

The step-down jumper 2016-499 is suitable for commoning 16 / 10 mm² (AWG 4 / 6) terminal blocks with 10 / 6 / 4 / 2.5 mm² (AWG 6 / 8 / 10 / 12) terminal blocks. The step-down jumper 2006-499 is suitable for commoning 6 / 4 mm² (AWG 8 / 10) terminal blocks with 4 / 2.5 / 1.5 mm² (AWG 10 / 12 / 14) terminal blocks.

with push-in type jumper bars

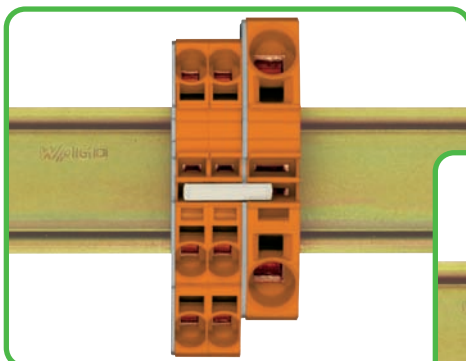

When commoning on the open side of the block using an end plate, terminal blocks 16 mm² (AWG 4) and 10 mm² (AWG 6) can be commoned with terminal blocks rated two sizes below the rated cross section and terminal blocks 6 (AWG 8) / 4 (AWG 10) and 2.5 mm² (AWG 12) can be commoned with terminal blocks rated one size below the rated cross section.

For example, terminal blocks 16 mm² (AWG 4) can be commoned with terminal blocks 6 mm² (AWG 8) (see ill.) or terminal blocks 10 mm² (AWG 6) with terminal blocks 4 mm² (AWG 10).

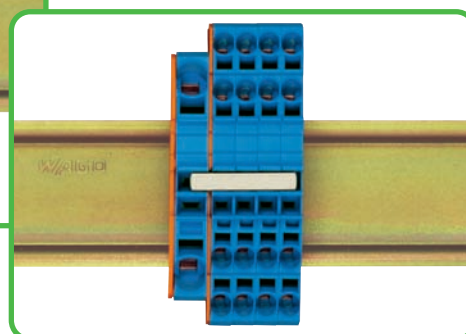

When commoning on the back side of the block using an end plate, terminal blocks can be commoned with terminal blocks rated two sizes below the rated cross section. For example, 16 mm² (AWG 4) terminal blocks can be commoned with terminal blocks 6 mm² (AWG 8) or terminal blocks 6 mm² (AWG 8) with terminal blocks 2.5 mm² (AWG 12) (see ill.).

Simply tested

with jumper slot for connectors

Modular TOPJOB® S connectors

The spring-loaded jumper system of the TOPJOB® S rail-mounted terminal blocks is suited for testing accessories like test plug adapters and testing taps as well as modular TOPJOB® S connectors. Modular connectors with CAGE CLAMP® S technology offer an additional connection option for conductors having the same size as the corresponding rail-mounted terminal block. Additionally, terminal blocks can be skipped using spacer modules.

Note: Disconnected connectors should not be live. Furthermore, connectors used according to the regulations should not be connected or disconnected under load.

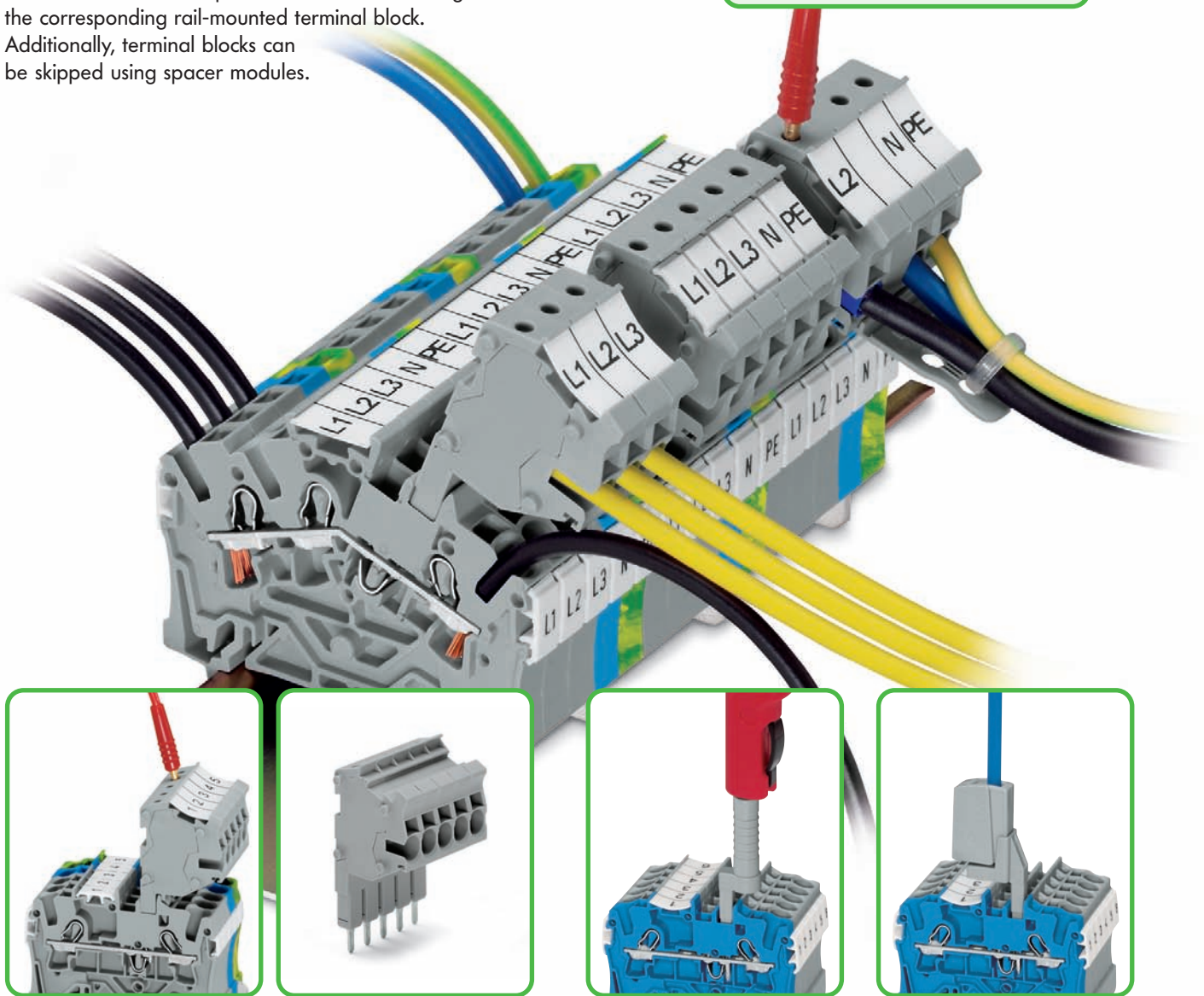

Modular connectors and connector strips

The modular connectors for the Series 2001, 2002 and 2004 are equipped with a $\varnothing 2 \text{ mm}/0.079 \text{ in}$ or $\varnothing 2.3 \text{ mm}/0.091 \text{ in}$ test socket. Additionally, 2 to 10-pole connector strips for the Series 2001 and 2002 as well as 2 to 5-pole connector strips for the Series 2004 are available.

Testing tap

Testing tap suited for Series 2001 to 2016. Individual test wires up to 2.5 mm^2 (AWG 12) can be connected without using any tools.

Connectors

Connectors for Series 2001, 2002 and 2004 are equipped with a $\varnothing 2 \text{ mm}/0.079 \text{ in}$ or $\varnothing 2.3 \text{ mm}/0.091 \text{ in}$ test socket.

Simply marked

- Finding the appropriate marking easily and quickly using WMB markers or continuous marker strips

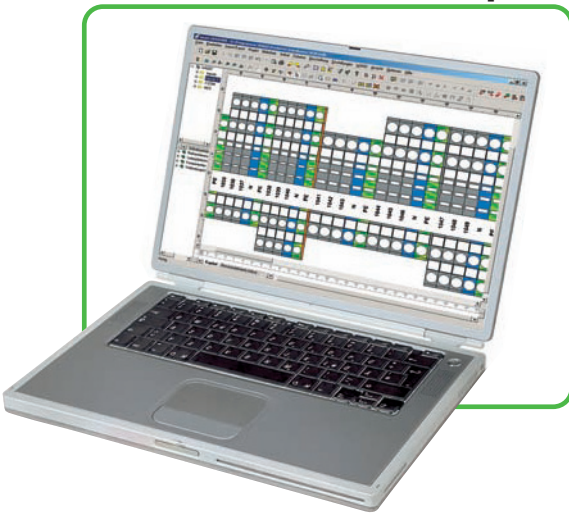

Designing ...

Custom rail assemblies and markings can be designed easily using the WAGO ProServe 4.1 software.

Printing ...

A thermal transfer printer is used to print marker strips (Series 2009) or WMB markers on a continuous reel.

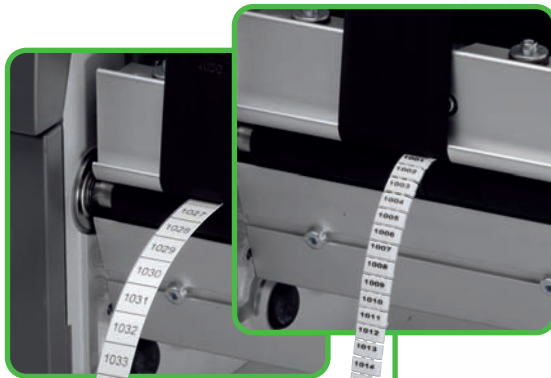

Snapping ...

The marker strip is snapped into the center marker receptacle profile.

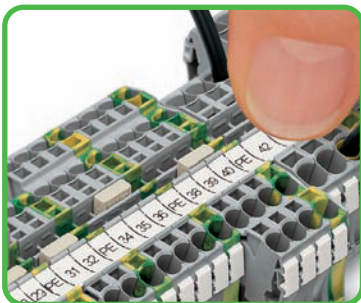

Combining marker strips and individual WMB markers.



Alternatively, miniature WSB markers can be printed using a plotter.

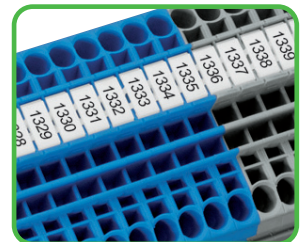

Three receptacles are available for WMB markers on continuous reel.

TOPJOB[®]S



3- and 4-conductor terminal blocks
2.5 mm² (AWG 12)

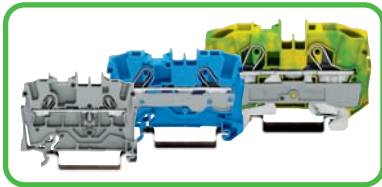

2-conductor terminal blocks
1.5 mm² (AWG 14); 2.5 mm² (AWG 12);
4 mm² (AWG 10); 6 mm² (AWG 8);
10 mm² (AWG 6); 16 mm² (AWG 4)



3-conductor terminal blocks
1.5 mm² (AWG 14); 2.5 mm² (AWG 12);
4 mm² (AWG 10); 6 mm² (AWG 8);
10 mm² (AWG 6); 16 mm² (AWG 4)

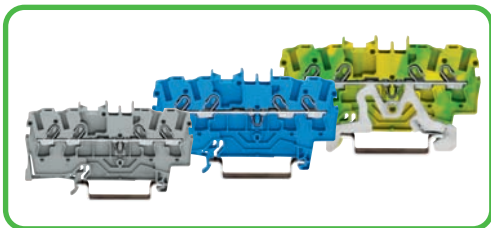

4-conductor terminal blocks
1.5 mm² (AWG 14);
2.5 mm² (AWG 12);
4 mm² (AWG 10)

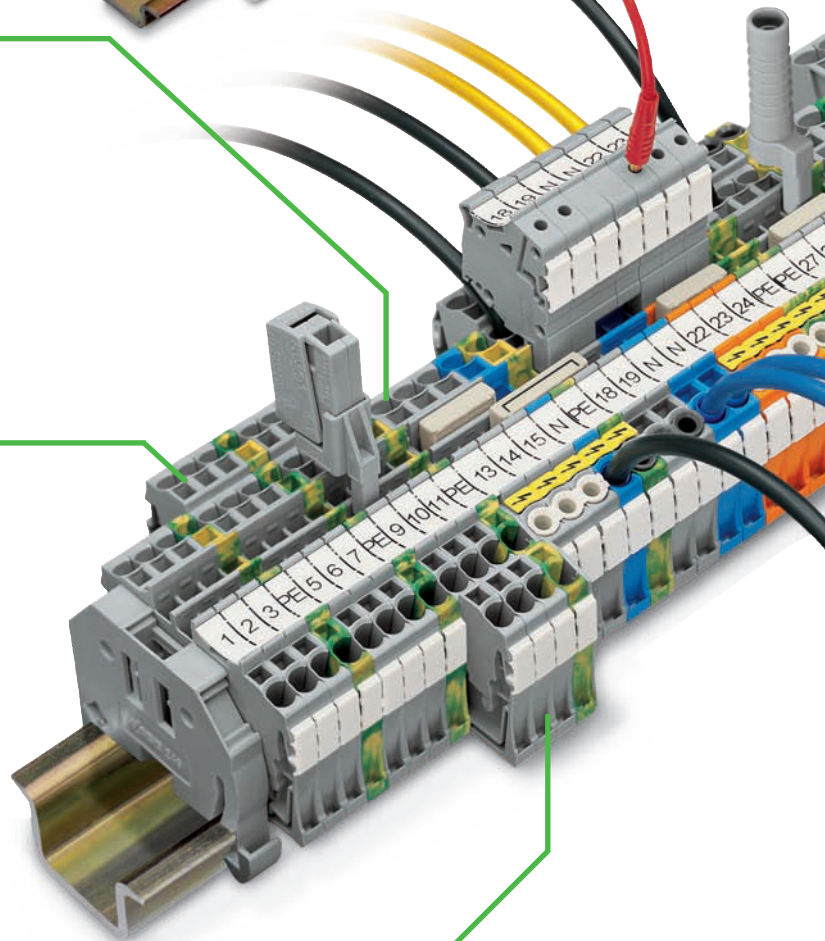
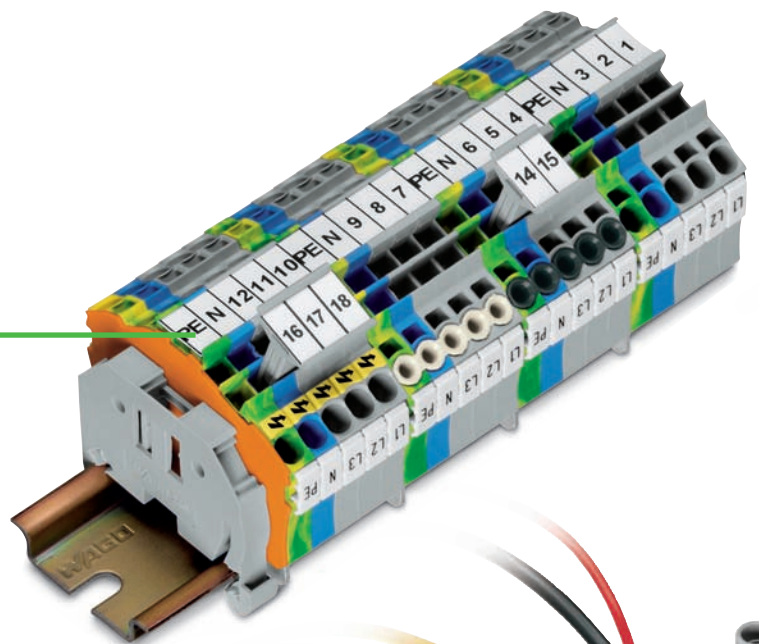

Series	2001	2002	2004	2006	2010	2016
Rated cross section	1.5 mm ² AWG 14	2.5 mm ² AWG 12	4 mm ² AWG 10	6 mm ² AWG 8	10 mm ² AWG 6	16 mm ² AWG 4

TOPJOB[®]S

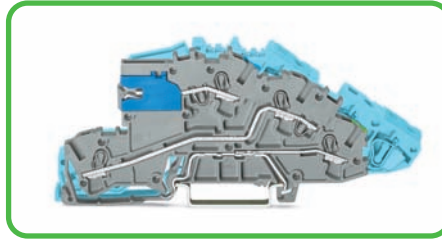

Very compact dimensions provide maximum wiring space in standard distribution boxes. The 2003 Series multilevel installation terminal blocks are the smallest terminal blocks with direct insertion wire connection on the market providing the full functionality of a 4 mm² terminal block.

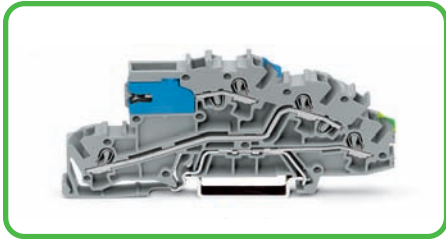

Push-in type jumper bars with breakable contact lugs offer the same benefits to the TOPJOB[®]S installation terminal blocks as to the rail-mounted terminal blocks (e.g. individual jumper configuration on site, skipping of potentials, etc.).



Screwless N-disconnect slide link for automatic and safe connection onto the N-busbar by simply sliding the link.

The busbar carrier with end stop function, which is only **7.5 mm wide** can replace end stop.

The detachable separator plate on the carrier can be used both for separating the different potentials of N-busbars that are directly next to each other or as a touch-proof end plate for an N-busbar.

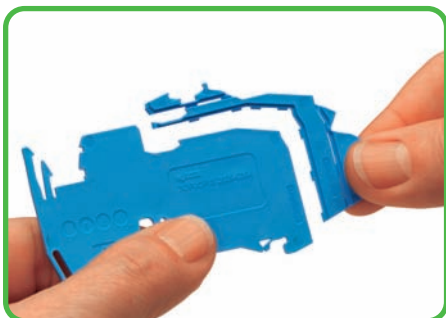

The compact busbar carrier, which is placed every 200 mm, is used to additionally support the busbar on a long assembly.

Perforations make it possible to fit the carrier to all TOPJOB[®]S installation terminal blocks using a single part.

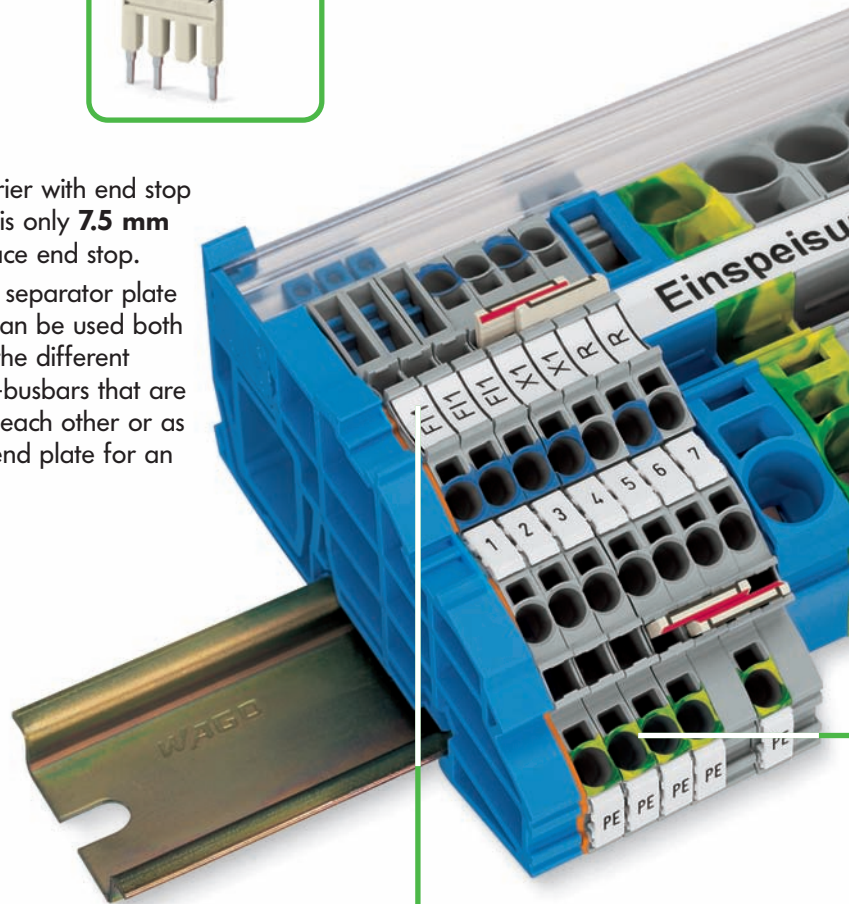

Each connection point has an individual marker receptacle for WMB markers. Additionally, the upper marker receptacle is suitable for marker strips that can be marked manually using a marker pen or automatically by a thermal transfer printer.



Commoning is done using the new staggered jumper system in one single TOPJOB®S jumper slot. The multilevel installation terminal blocks of Series 2003 are therefore suitable for use in very confined spaces.

The optional busbar transparent cover (item no. 777-303) protects the busbar against accidental contact and makes it easy to see which terminal blocks are connected to the busbar.

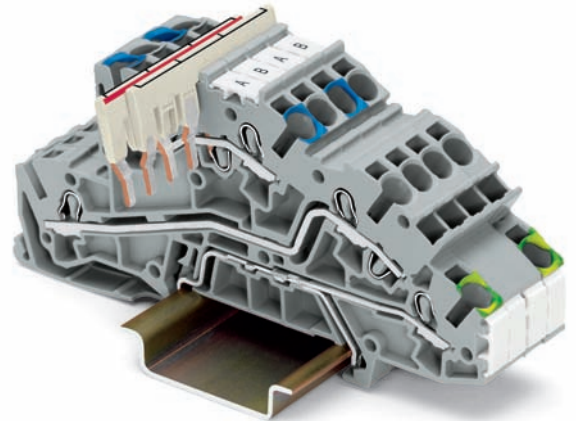
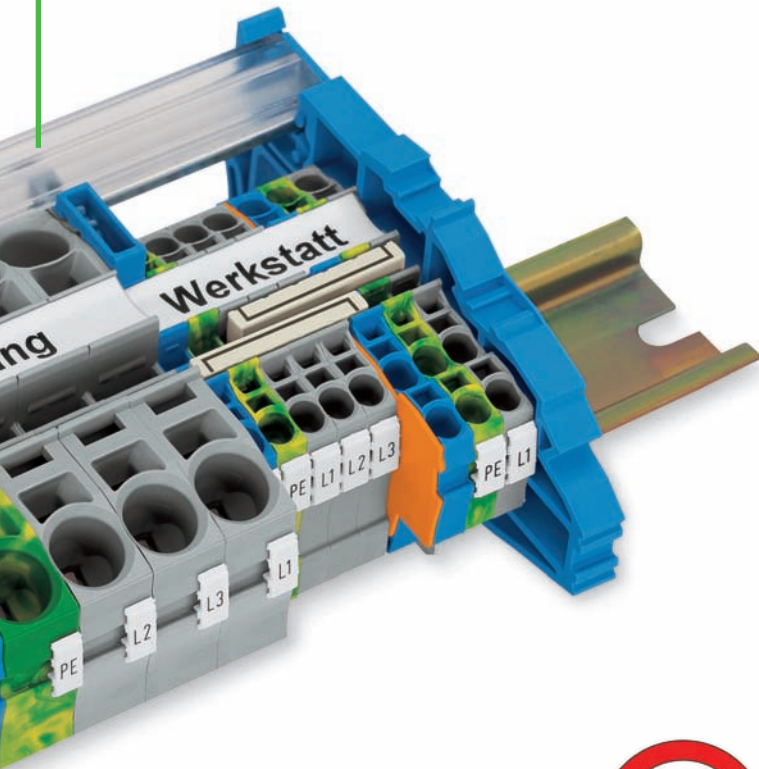

Removal of staggered jumpers

Insert the screwdriver blade between the jumpers and lift them up.

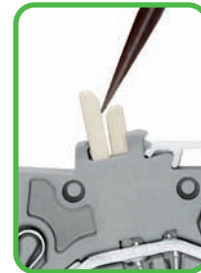

Environmentally friendly:

TOPJOB®S terminal blocks are **100 % lead-free!**



The conductor entry holes of the multilevel installation terminal blocks are color marked, providing a clear arrangement of the terminals.

The grounding foot automatically guarantees a safe connection to the carrier rail.

TOPJOB®S – The range of terminal blocks for all types of applications.

- The direct connection of solid wires in small distribution boxes saves time and money.
- Operating errors can be prevented as all types of terminal blocks for building installation are equipped with push-in connection technology.
- Terminal blocks for building installation expand circuit design possibilities.
- The use of standard accessories reduces order-processing and stock-holding costs.
- A high level of application safety is achieved through optimum knowledge of the small range of parts.
- As the position of the busbars is the same, the new TOPJOB®S installation terminal blocks are compatible with standard topJob installation terminal blocks.



TOPJOB[®]S

Movable knife disconnects clearly indicate the circuit state.

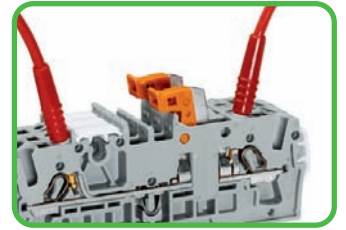

2- and 4-conductor disconnect terminal blocks

The 5.2 mm wide 2- and 4-conductor disconnect terminal blocks, that can be used in both control and process measurement systems as well as transformer circuits, are an addition to the range of TOPJOB[®]S rail-mounted terminal blocks.

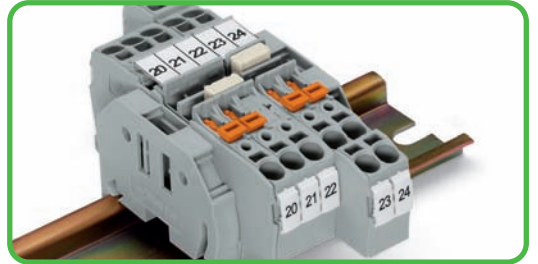
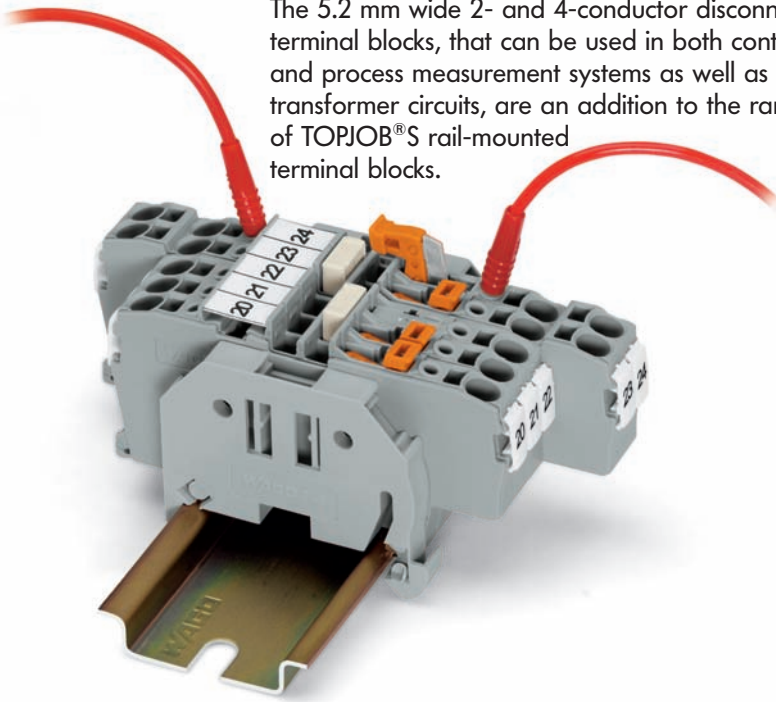

Two lateral and one centre marker receptacle for WMB markers or marking strips. Dual jumper slots, in the same position as the other 2002 Series terminal blocks. Commoning options in front of or behind the knife disconnect, depending on which is the power supply side.



Additional marking option using pivoting marking adapters.

Double deck double disconnect terminal blocks

Disconnect terminal blocks of independent potentials are accommodated on two levels in a double deck disconnect terminal block. This results in a space saving arrangement without compromising the clarity of operation. The knife disconnects are located between the conductors and are therefore always in full view of the operator.

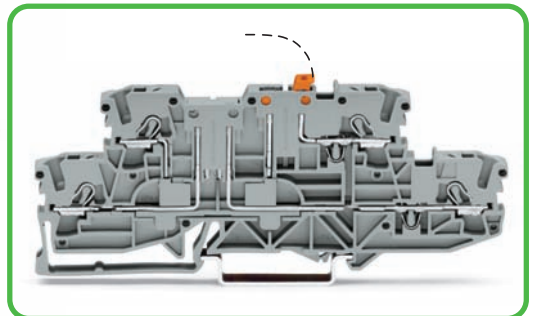
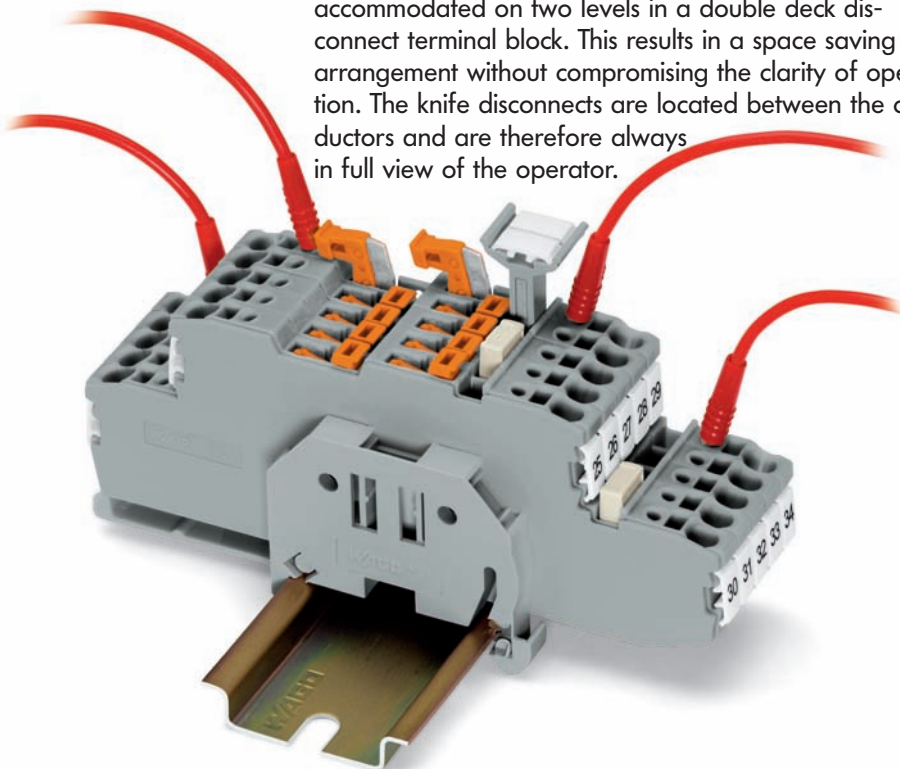

One disconnect and one through terminal block are accommodated on two levels in a terminal block that is only 5.2 mm wide.

TOPJOB[®]S

These double and triple deck diode terminal blocks have been specially developed for custom diode circuits such as lamp test and collective fault signal circuits.

Using LED terminal blocks, monitoring units can be designed for control and operating circuits.

The terminal blocks provide high density wiring maintaining a width of only 5.2 mm.

Using push-in type jumper bars opens up additional possibilities when designing custom circuits.

Double deck diode terminal blocks

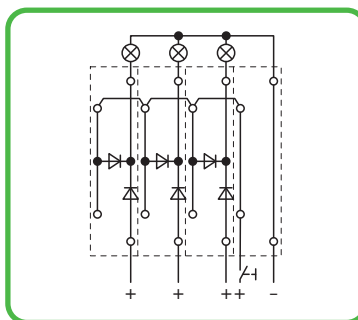
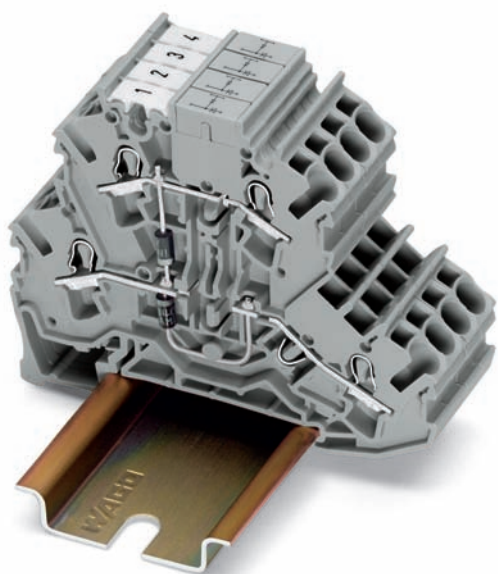

Lamp test circuit

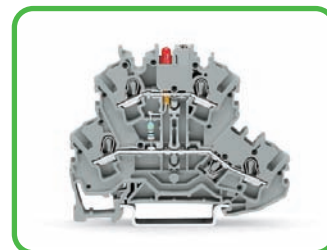



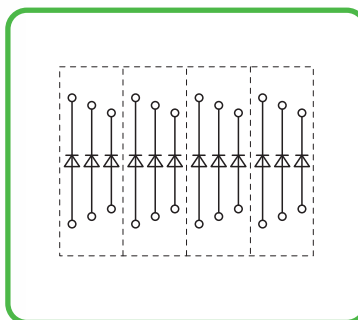
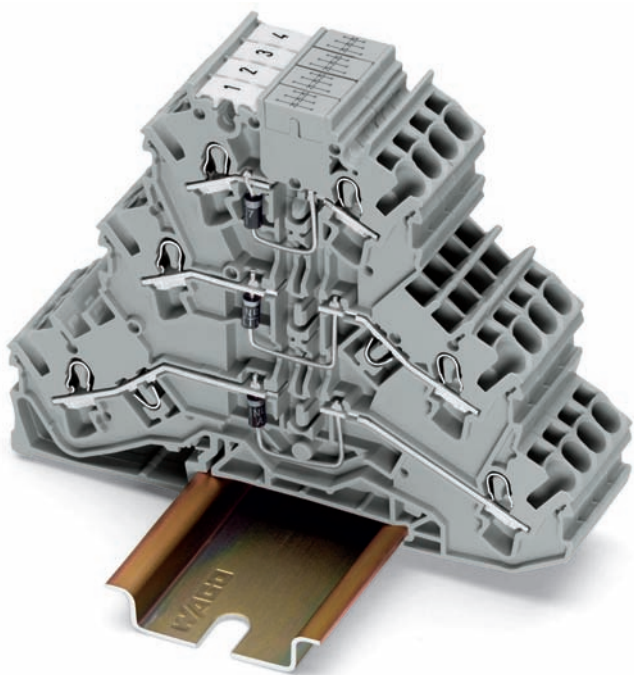



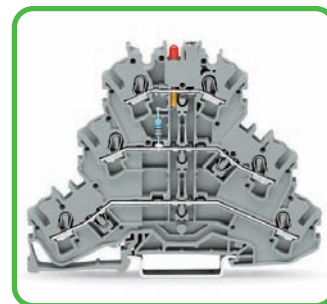
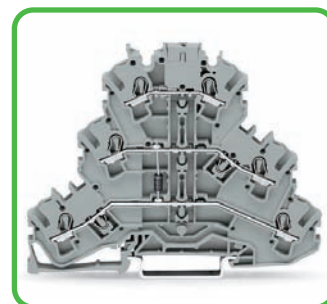













Triple deck diode terminal blocks



Open diode gate, can be connected individually. Using push-in type jumper bars, individual levels can be turned into polarized diode gates.









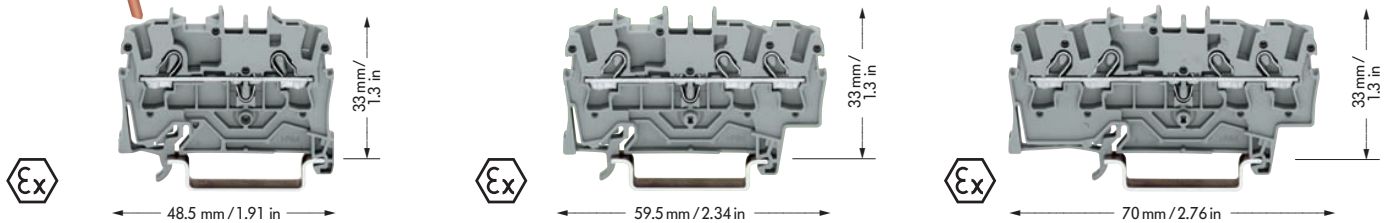















TOPJOB® Rail-Mounted Terminal Blocks 1.5 (2.5) mm²/AWG 14 Series 2001

0.25 – 1.5 (2.5) mm² Ⓢ 800 V/8 kV/3 18 A Terminal block width 4.2 mm / 0.165 in  9 – 11 mm / 0.39 in *  	0.25 – 1.5 (2.5) mm² Ⓢ AWG 22 – 14 600 V, 15 A   600 V, 15 A   Terminal block width 4.2 mm / 0.165 in  9 – 11 mm / 0.39 in *  	0.25 – 1.5 (2.5) mm² Ⓢ 800 V/8 kV/3 18 A Terminal block width 4.2 mm / 0.165 in  9 – 11 mm / 0.39 in *  	0.25 – 1.5 (2.5) mm² Ⓢ AWG 22 – 14 600 V, 15 A   600 V, 15 A   Terminal block width 4.2 mm / 0.165 in  9 – 11 mm / 0.39 in *  
--	---	--	---















Ⓢ can be connected: 0.25 mm² – 2.5 mm² "s + f-st";
 can be pushed in directly: 0.5 mm² – 2.5 mm² "s" and 0.75 mm² – 1.5 mm² "insulated ferrule, 12 mm"



Item No.	Pack.-unit pcs	Item No.	Pack.-unit pcs	Item No.	Pack.-unit pcs
2-conductor through terminal blocks		3-conductor through terminal blocks		4-conductor through terminal blocks	
grey 	2001-1201 	100	grey 	2001-1301 	100
blue 	2001-1204 	100	blue 	2001-1304 	100
orange 	2001-1202 	100	orange 	2001-1302 	100
more colors are being prepared		more colors are being prepared		more colors are being prepared	
2-conductor ground (earth) terminal block		3-conductor ground (earth) terminal block		4-conductor ground (earth) terminal block	
green-yellow 	2001-1207 	100	green-yellow 	2001-1307 	100
 Suitable for Ex e II applications 550 V, 17 A		 Suitable for Ex e II applications 550 V, 17 A		 Suitable for Ex e II applications 550 V, 17 A	
 Suitable for Ex i applications		 Suitable for Ex i applications		 Suitable for Ex i applications	

Accessories

appropriate marker system **WMB/Marker strips** (see pages 38 to 39)

End and intermediate plate, 0.8 mm/0.031 in thick  orange 2002-1292 100 (4 x 25) grey 2002-1291 100 (4 x 25)	End and intermediate plate, 0.8 mm/0.031 in thick  orange 2002-1392 100 (4 x 25) grey 2002-1391 100 (4 x 25)	End and intermediate plate, 0.8 mm/0.031 in thick  orange 2002-1492 100 (4 x 25) grey 2002-1491 100 (4 x 25)
Insulation stop, 5 pcs/strip 200 strips  light grey 2001-171 0.25-0.5 mm ²	Insulation stop, 5 pcs/strip 200 strips  light grey 2001-171 0.25-0.5 mm ²	Insulation stop, 5 pcs/strip 200 strips  light grey 2001-171 0.25-0.5 mm ²
Push-in type jumper bars, light grey, insulated, I _N 18 A  16 A 2-way 2001-402 200 (8 x 25) 3-way 2001-403 200 (8 x 25) 4-way 2001-404 200 (8 x 25) 5-way 2001-405 100 (4 x 25) : 10-way 2001-410 100 (4 x 25)	Push-in type jumper bars, light grey, insulated, I _N 18 A  16 A 2-way 2001-402 200 (8 x 25) 3-way 2001-403 200 (8 x 25) 4-way 2001-404 200 (8 x 25) 5-way 2001-405 100 (4 x 25) : 10-way 2001-410 100 (4 x 25)	Push-in type jumper bars, light grey, insulated, I _N 18 A  16 A 2-way 2001-402 200 (8 x 25) 3-way 2001-403 200 (8 x 25) 4-way 2001-404 200 (8 x 25) 5-way 2001-405 100 (4 x 25) : 10-way 2001-410 100 (4 x 25)
Push-in type jumper bars, light grey, insulated, I _N 18 A  16 A 1 - 3 2001-433 200 (8 x 25) 1 - 4 2001-434 200 (8 x 25) 1 - 5 2001-435 100 (4 x 25) : 1 - 10 2001-440 100 (4 x 25)	Push-in type jumper bars, light grey, insulated, I _N 18 A  16 A 1 - 3 2001-433 200 (8 x 25) 1 - 4 2001-434 200 (8 x 25) 1 - 5 2001-435 100 (4 x 25) : 1 - 10 2001-440 100 (4 x 25)	Push-in type jumper bars, light grey, insulated, I _N 18 A  16 A 1 - 3 2001-433 200 (8 x 25) 1 - 4 2001-434 200 (8 x 25) 1 - 5 2001-435 100 (4 x 25) : 1 - 10 2001-440 100 (4 x 25)
Modular TOPJOB®S connector**, for jumper contact slot 1 pole 2001-501 100 (4 x 25)	Modular TOPJOB®S connector**, for jumper contact slot 1 pole 2001-501 100 (4 x 25)	Modular TOPJOB®S connector**, for jumper contact slot 1 pole 2001-501 100 (4 x 25)
Spacer, modular 2001-549 100 (4 x 25) see also pages 24 to 25	Spacer, modular 2001-549 100 (4 x 25) see also pages 24 to 25	Spacer, modular 2001-549 100 (4 x 25) see also pages 24 to 25
Test plug adapter, for test plug 4 mm/0.157 in Ø  2009-174 100 (4 x 25) Testing tap, for max. 2.5 mm² 2009-182 100 (4 x 25)	Test plug adapter, for test plug 4 mm/0.157 in Ø  2009-174 100 (4 x 25) Testing tap, for max. 2.5 mm² 2009-182 100 (4 x 25)	Test plug adapter, for test plug 4 mm/0.157 in Ø  2009-174 100 (4 x 25) Testing tap, for max. 2.5 mm² 2009-182 100 (4 x 25)
Marker strip, white, plain, on roll for center marking 11 mm/0.039 in wide 50 m 2009-110 1 300 m 2009-130 1	Marker strip, white, plain, on roll for center marking 11 mm/0.039 in wide 50 m 2009-110 1 300 m 2009-130 1	Marker strip, white, plain, on roll for center marking 11 mm/0.039 in wide 50 m 2009-110 1 300 m 2009-130 1

* For further approvals with corresponding ratings see page 49.

TOPJOB® Rail-Mounted Terminal Blocks 2.5 (4) mm²/AWG 12 Series 2002

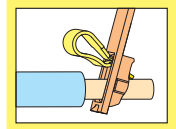

0.25 – 2.5 (4) mm² ① 800 V/8 kV/3 24 A Terminal block width 5.2 mm / 0.205 in 10 – 12 mm / 0.43 in *	AWG 22 – 12 600 V, 20 A 600 V, 20 A	0.25 – 2.5 (4) mm² ① 800 V/8 kV/3 24 A Terminal block width 5.2 mm / 0.205 in 10 – 12 mm / 0.43 in *	AWG 22 – 12 600 V, 20 A 600 V, 20 A	0.25 – 2.5 (4) mm² ① 800 V/8 kV/3 24 A Terminal block width 5.2 mm / 0.205 in 10 – 12 mm / 0.43 in *	AWG 22 – 12 600 V, 20 A 600 V, 20 A
---	--	---	--	---	--

① can be connected: 0.25 mm² – 4 mm² "s + f-st";
 can be pushed in directly: 0.75 mm² – 4 mm² "s" and 0.75 mm² – 2.5 mm² "insulated ferrule, 12 mm"

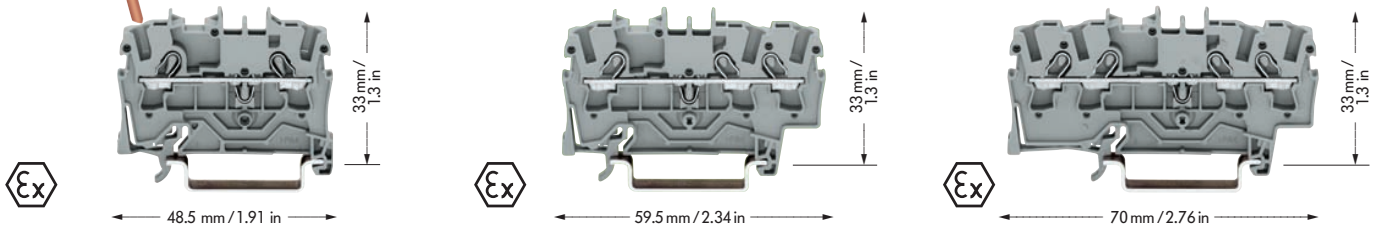

Item No.	Pack.-unit pcs	Item No.	Pack.-unit pcs	Item No.	Pack.-unit pcs
2-conductor through terminal blocks		3-conductor through terminal blocks		4-conductor through terminal blocks	
grey	2002-1201	100	grey	2002-1301	100
blue	2002-1204	100	blue	2002-1304	100
orange	2002-1202	100	orange	2002-1302	100
more colors are being prepared		more colors are being prepared		more colors are being prepared	
2-conductor ground (earth) terminal block		3-conductor ground (earth) terminal block		4-conductor ground (earth) terminal block	
green-yellow	2002-1207	100	green-yellow	2002-1307	100
Suitable for Ex e II applications 550 V, 22 A		Suitable for Ex e II applications 550 V, 22 A		Suitable for Ex e II applications 550 V, 22 A	
Suitable for Ex i applications		Suitable for Ex i applications		Suitable for Ex i applications	















Accessories

appropriate marker system **WMB/Marker strips** (see pages 38 to 39)









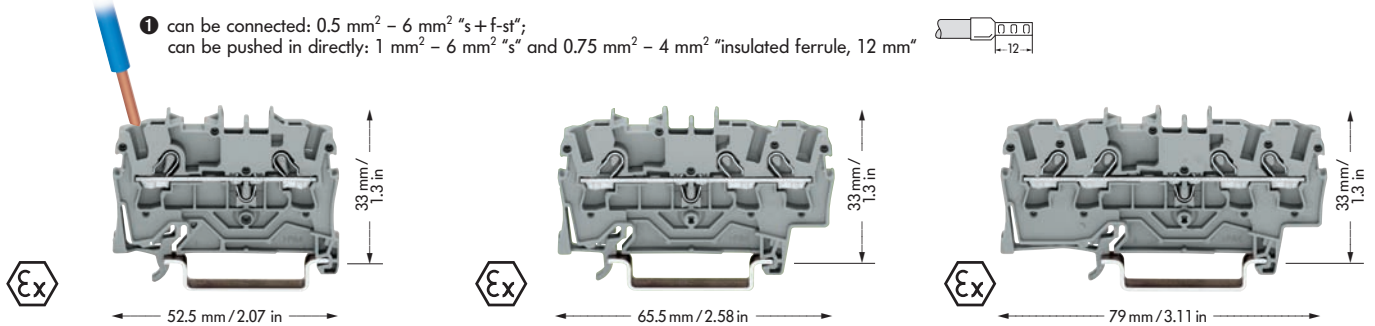





















End and intermediate plate, 0.8 mm / 0.031 in thick orange 2002-1292 100 (4 x 25) grey 2002-1291 100 (4 x 25)	End and intermediate plate, 0.8 mm / 0.031 in thick orange 2002-1392 100 (4 x 25) grey 2002-1391 100 (4 x 25)	End and intermediate plate, 0.8 mm / 0.031 in thick orange 2002-1492 100 (4 x 25) grey 2002-1491 100 (4 x 25)
Insulation stop, 5 pcs/strip 200 strips light grey 2002-171 0.25-0.5 mm ² dark grey 2002-172 0.75-1 mm ²	Insulation stop, 5 pcs/strip 200 strips light grey 2002-171 0.25-0.5 mm ² dark grey 2002-172 0.75-1 mm ²	Insulation stop, 5 pcs/strip 200 strips light grey 2002-171 0.25-0.5 mm ² dark grey 2002-172 0.75-1 mm ²
Push-in type jumper bars, light grey, insulated, I _N 25 A 20 A 2-way 2002-402 200 (8 x 25) 3-way 2002-403 200 (8 x 25) 4-way 2002-404 200 (8 x 25) : : 10-way 2002-410 100 (4 x 25)	Push-in type jumper bars, light grey, insulated, I _N 25 A 20 A 2-way 2002-402 200 (8 x 25) 3-way 2002-403 200 (8 x 25) 4-way 2002-404 200 (8 x 25) : : 10-way 2002-410 100 (4 x 25)	Push-in type jumper bars, light grey, insulated, I _N 25 A 20 A 2-way 2002-402 200 (8 x 25) 3-way 2002-403 200 (8 x 25) 4-way 2002-404 200 (8 x 25) : : 10-way 2002-410 100 (4 x 25)
Staggered jumper, see page 28	Staggered jumper, see page 28	Staggered jumper, see page 28
Push-in type jumper bars, light grey, insulated, I _N 25 A 20 A 1 - 3 2002-433 200 (8 x 25) 1 - 4 2002-434 200 (8 x 25) 1 - 5 2002-435 100 (4 x 25) : : 1 - 10 2002-440 100 (4 x 25)	Push-in type jumper bars, light grey, insulated, I _N 25 A 20 A 1 - 3 2002-433 200 (8 x 25) 1 - 4 2002-434 200 (8 x 25) 1 - 5 2002-435 100 (4 x 25) : : 1 - 10 2002-440 100 (4 x 25)	Push-in type jumper bars, light grey, insulated, I _N 25 A 20 A 1 - 3 2002-433 200 (8 x 25) 1 - 4 2002-434 200 (8 x 25) 1 - 5 2002-435 100 (4 x 25) : : 1 - 10 2002-440 100 (4 x 25)
Protective warning marker, for 5 terminal blocks yellow 2002-115 100 (4 x 25)	Protective warning marker, for 5 terminal blocks yellow 2002-115 100 (4 x 25)	Protective warning marker, for 5 terminal blocks yellow 2002-115 100 (4 x 25)
Modular TOPJOB®S connector**, for jumper contact slot 1 pole 2002-511 100 (4 x 25)	Modular TOPJOB®S connector**, for jumper contact slot 1 pole 2002-511 100 (4 x 25)	Modular TOPJOB®S connector**, for jumper contact slot 1 pole 2002-511 100 (4 x 25)
Spacer, modular 2002-549 100 (4 x 25) see also pages 24 to 25	Spacer, modular 2002-549 100 (4 x 25) see also pages 24 to 25	Spacer, modular 2002-549 100 (4 x 25) see also pages 24 to 25
Test plug adapter, for test plug 4 mm / 0.157 in Ø 2009-174 100 (4 x 25) Testing tap, for max. 2.5 mm² 2009-182 100 (4 x 25)	Test plug adapter, for test plug 4 mm / 0.157 in Ø 2009-174 100 (4 x 25) Testing tap, for max. 2.5 mm² 2009-182 100 (4 x 25)	Test plug adapter, for test plug 4 mm / 0.157 in Ø 2009-174 100 (4 x 25) Testing tap, for max. 2.5 mm² 2009-182 100 (4 x 25)



























* For further approvals with corresponding ratings see page 49.

TOPJOB® Rail-Mounted Terminal Blocks 4 (6) mm²/AWG 10 Series 2004

0.5 – 4 (6) mm² ① 800 V/8 kV/3 32 A Terminal block width 6.2 mm / 0.244 in  11 – 13 mm / 0.47 in *  	AWG 20 – 10 600 V, 30 A  600 V, 30 A 	0.5 – 4 (6) mm² ① 800 V/8 kV/3 32 A Terminal block width 6.2 mm / 0.244 in  11 – 13 mm / 0.47 in *  	AWG 20 – 10 600 V, 30 A  600 V, 30 A 	0.5 – 4 (6) mm² ① 800 V/8 kV/3 32 A Terminal block width 6.2 mm / 0.244 in  11 – 13 mm / 0.47 in *  	AWG 20 – 10 600 V, 30 A  600 V, 30 A 
--	--	--	--	--	--





Item No.	Pack.-unit pcs	Item No.	Pack.-unit pcs	Item No.	Pack.-unit pcs			
2-conductor through terminal blocks			3-conductor through terminal blocks			4-conductor through terminal blocks		
grey 	2004-1201 	50	grey 	2004-1301 	50	grey 	2004-1401 	50
blue 	2004-1204 	50	blue 	2004-1304 	50	blue 	2004-1404 	50
orange 	2004-1202 	50	orange 	2004-1302 	50	orange 	2004-1402 	50
weitere Farbvarianten in Vorbereitung			weitere Farbvarianten in Vorbereitung			weitere Farbvarianten in Vorbereitung		
2-conductor ground (earth) terminal block			3-conductor ground (earth) terminal block			4-conductor ground (earth) terminal block		
green-yellow 	2004-1207 	50	green-yellow 	2004-1307 	50	green-yellow 	2004-1407 	50
 Suitable for Ex e II applications 550 V, 30 A			 Suitable for Ex e II applications 550 V, 30 A			 Suitable for Ex e II applications 550 V, 30 A		
 Suitable for Ex i applications			 Suitable for Ex i applications			 Suitable for Ex i applications		

Accessories			appropriate marker system WMB/Marker strips/WMB Inline (see pages 38 to 39)					
End and intermediate plate, 1 mm/0.039 in thick			End and intermediate plate, 1 mm/0.039 in thick			End and intermediate plate, 1 mm/0.039 in thick		
	orange 2004-1292 100 (4 x 25)			orange 2004-1392 100 (4 x 25)			orange 2004-1492 100 (4 x 25)	
	grey 2004-1291 100 (4 x 25)			grey 2004-1391 100 (4 x 25)			grey 2004-1491 100 (4 x 25)	
Insulation stop, 5 pcs/strip 200 strips			Insulation stop, 5 pcs/strip 200 strips			Insulation stop, 5 pcs/strip 200 strips		
	light grey 2004-171 0.25-0.5 mm ²			light grey 2004-171 0.25-0.5 mm ²			light grey 2004-171 0.25-0.5 mm ²	
	dark grey 2004-172 0.75-1 mm ²			dark grey 2004-172 0.75-1 mm ²			dark grey 2004-172 0.75-1 mm ²	
Push-in type jumper bars, light grey, insulated, I_N 32A  30 A			Push-in type jumper bars, light grey, insulated, I_N 32A  30 A			Push-in type jumper bars, light grey, insulated, I_N 32A  30 A		
	2-fach 2004-402 100 (4 x 25)			2-fach 2004-402 100 (4 x 25)			2-fach 2004-402 100 (4 x 25)	
	3-fach 2004-403 100 (4 x 25)			3-fach 2004-403 100 (4 x 25)			3-fach 2004-403 100 (4 x 25)	
	4-fach 2004-404 100 (4 x 25)			4-fach 2004-404 100 (4 x 25)			4-fach 2004-404 100 (4 x 25)	
	5-fach 2004-405 50 (2 x 25)			5-fach 2004-405 50 (2 x 25)			5-fach 2004-405 50 (2 x 25)	
:	:		:	:		:	:	
	10-fach 2004-410 50 (2 x 25)			10-fach 2004-410 50 (2 x 25)			10-fach 2004-410 50 (2 x 25)	
Push-in type jumper bars, light grey, insulated, I_N 32A  30 A			Push-in type jumper bars, light grey, insulated, I_N 32A  30 A			Push-in type jumper bars, light grey, insulated, I_N 32A  30 A		
	1 - 3 2004-433 100 (4 x 25)			1 - 3 2004-433 100 (4 x 25)			1 - 3 2004-433 100 (4 x 25)	
	1 - 4 2004-434 100 (4 x 25)			1 - 4 2004-434 100 (4 x 25)			1 - 4 2004-434 100 (4 x 25)	
	1 - 5 2004-435 50 (2 x 25)			1 - 5 2004-435 50 (2 x 25)			1 - 5 2004-435 50 (2 x 25)	
:	:		:	:		:	:	
	1 - 10 2004-440 50 (2 x 25)			1 - 10 2004-440 50 (2 x 25)			1 - 10 2004-440 50 (2 x 25)	
Protective warning marker, for 5 terminal blocks			Protective warning marker, for 5 terminal blocks			Protective warning marker, for 5 terminal blocks		
	yellow 2004-115 100 (4 x 25)			yellow 2004-115 100 (4 x 25)			yellow 2004-115 100 (4 x 25)	
Modular TOPJOB®S connector**, for jumper contact slot			Modular TOPJOB®S connector**, for jumper contact slot			Modular TOPJOB®S connector**, for jumper contact slot		
	1 pole 2004-511 100 (4 x 25)			1 pole 2004-511 100 (4 x 25)			1 pole 2004-511 100 (4 x 25)	
Spacer, modular 2004-549 100 (4 x 25) see also pages 24 to 25			Spacer, modular 2004-549 100 (4 x 25) see also pages 24 to 25			Spacer, modular 2004-549 100 (4 x 25) see also pages 24 to 25		
Test plug adapter, for test plug 4 mm/0.157 in Ø			Test plug adapter, for test plug 4 mm/0.157 in Ø			Test plug adapter, for test plug 4 mm/0.157 in Ø		
	2009-174 100 (4 x 25)			2009-174 100 (4 x 25)			2009-174 100 (4 x 25)	
	Testing tap, for max. 2.5 mm²			Testing tap, for max. 2.5 mm²			Testing tap, for max. 2.5 mm²	
	2009-182 100 (4 x 25)			2009-182 100 (4 x 25)			2009-182 100 (4 x 25)	

* For further approvals with corresponding ratings see page 49.

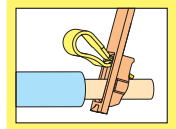
TOPJOB® Rail-Mounted Terminal Blocks 6 (10) mm²/AWG 8 Series 2006



0.5 – 6 (10) mm² ⓐ 800 V/8 kV/3 41 A Terminal block width 7.5 mm / 0.295 in  13 – 15 mm / 0.55 in * ⓐ ⓑ Ⓒ	AWG 20 – 8 600 V, 50 A ⓐ 600 V, 50 A ⓑ	0.5 – 6 (10) mm² ⓐ 800 V/8 kV/3 41 A Terminal block width 7.5 mm / 0.295 in  13 – 15 mm / 0.55 in * ⓐ ⓑ Ⓒ	AWG 20 – 8 600 V, 50 A ⓐ 600 V, 50 A ⓑ	Commoning with step-down jumpers Application notes see page 7
---	---	---	---	---



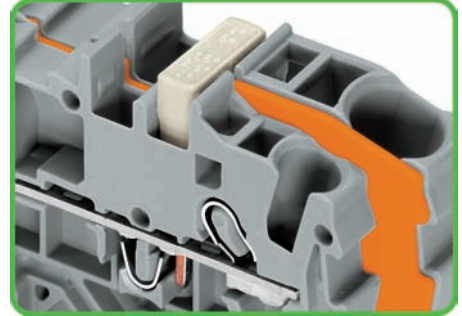
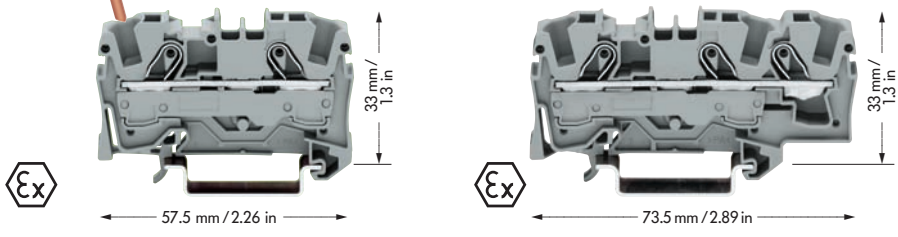









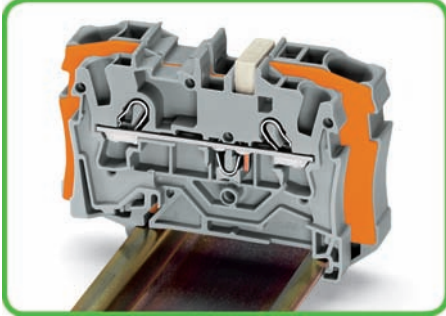

ⓐ can be connected: 0.5 mm² – 10 mm² "s + f-st";
 can be pushed in directly: 1.5 mm² – 10 mm² "s" and
 1.5 mm² – 6 mm² "insulated ferrule, 12 mm"



Item No.	Pack.-unit pcs	Item No.	Pack.-unit pcs	Item No.	Pack.-unit pcs
2-conductor through terminal blocks		3-conductor through terminal blocks		Commoning with step-down jumpers	
grey ⓐ 2006-1201 ● 50		grey ⓐ 2006-1301 ● 25		An end plate must always be used between the terminal blocks that are commoned with step-down jumpers.	
blue ⓐ 2006-1204 ⓑ 50		blue ⓐ 2006-1304 ⓑ 25		Step-down jumper 2006-499 is suitable for commoning	
orange ⓐ 2006-1202 ● 50		orange ⓐ 2006-1302 ● 25		AWG 10/12 (6/4 mm ²) terminal blocks with AWG	
2-conductor ground (earth) terminal block		3-conductor ground (earth) terminal block		12/14/16 (4/2.5/1.5 mm ²) terminal blocks.	
green-yellow ⓐ 2006-1207 ● 50		green-yellow ⓐ 2006-1307 ● 25		Step-down jumpers are simply pushed down to full insertion, in the same way as all other push-in type jumper bars.	
ⓐ Suitable for Ex e II applications 550 V, 38 A		ⓐ Suitable for Ex e II applications 550 V, 36 A			
ⓑ Suitable for Ex i applications		ⓑ Suitable for Ex i applications			

Accessories

appropriate marker system **WMB/Marker strips/WMB Inline** (see pages 38 to 39)











End and intermediate plate, 1 mm/0.039 in thick  orange 2006-1292 100 (4 x 25) grey 2006-1291 100 (4 x 25)	End and intermediate plate, 1 mm/0.039 in thick  orange 2006-1392 100 (4 x 25) grey 2006-1391 100 (4 x 25)	Step-down jumper, light grey, insulated  32 A 2006-499 50 (2 x 25)
Push-in type jumper bars, light grey, insulated, I_N 41 A  ⓐ 33 A 2-way 2006-402 50 (2 x 25) 3-way 2006-403 50 (2 x 25) 4-way 2006-404 50 (2 x 25) 5-way 2006-405 50 (2 x 25)	Push-in type jumper bars, light grey, insulated, I_N 41 A  ⓐ 33 A 2-way 2006-402 50 (2 x 25) 3-way 2006-403 50 (2 x 25) 4-way 2006-404 50 (2 x 25) 5-way 2006-405 50 (2 x 25)	
Push-in type jumper bars, light grey, insulated, I_N 41 A  ⓐ 33 A 1 - 3 2006-433 50 (2 x 25) 1 - 4 2006-434 50 (2 x 25) 1 - 5 2006-435 50 (2 x 25)	Push-in type jumper bars, light grey, insulated, I_N 41 A  ⓐ 33 A 1 - 3 2006-433 50 (2 x 25) 1 - 4 2006-434 50 (2 x 25) 1 - 5 2006-435 50 (2 x 25)	
Protective warning marker, for 5 terminal blocks  yellow 2006-115 100 (4 x 25)	Protective warning marker, for 5 terminal blocks  yellow 2006-115 100 (4 x 25)	
Test plug adapter, for test plug 4 mm/0.157 in Ø  2009-174 100 (4 x 25)	Test plug adapter, for test plug 4 mm/0.157 in Ø  2009-174 100 (4 x 25)	
Testing tap, for max. 2.5 mm²  2009-182 100 (4 x 25)	Testing tap, for max. 2.5 mm²  2009-182 100 (4 x 25)	
Marker strip, white, plain, on roll for center marking  11 mm/0.039 in wide 50 m 2009-110 1 300 m 2009-130 1	Marker strip, white, plain, on roll for center marking  11 mm/0.039 in wide 50 m 2009-110 1 300 m 2009-130 1	

Note:









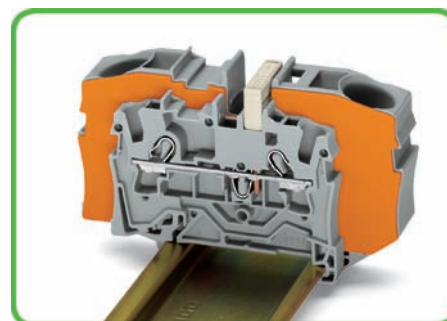
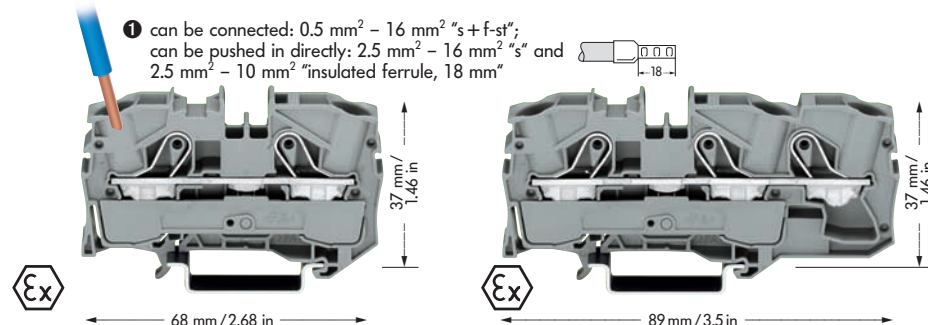











The total current flowing cannot exceed the rating of the step-down jumper/push-in type jumper bar.













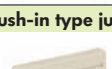
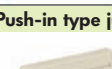





* For further approvals with corresponding ratings see page 49.

TOPJOB® S Rail-Mounted Terminal Blocks 10 (16) mm²/AWG 6 Series 2010

0.5 – 10 (16) mm² ① 800 V/8 kV/3 57 A Terminal block width 10 mm / 0.394 in  17 – 19 mm / 0.71 in *  	AWG 20 – 6 600 V, 65 A  600 V, 65 A 	0.5 – 10 (16) mm² ① 800 V/8 kV/3 57 A Terminal block width 10 mm / 0.394 in  17 – 19 mm / 0.71 in *  	AWG 20 – 6 600 V, 65 A  600 V, 65 A 	Commoning with step-down jumpers Application notes see page 7
---	---	---	---	--



Item No.	Pack.-unit pcs	Item No.	Pack.-unit pcs	Item No.	Pack.-unit pcs
2-conductor through terminal blocks		3-conductor through terminal blocks		Commoning with step-down jumpers	
grey 	2010-1201 	25	grey 	2010-1301 	25
blue 	2010-1204 	25	blue 	2010-1304 	25
orange 	2010-1202 	25	orange 	2010-1302 	25
2-conductor ground (earth) terminal block		3-conductor ground (earth) terminal block			
green-yellow 	2010-1207 	25	green-yellow 	2010-1307 	25
 Suitable for Ex e II applications 550 V, 51 A		 Suitable for Ex e II applications 550 V, 50 A			
 Suitable for Ex i applications		 Suitable for Ex i applications		Step-down jumpers are simply pushed down to full insertion, in the same way as all other push-in type jumper bars.	

Accessories		appropriate marker system WMB/Marker strips/WMB Inline (see pages 38 to 39)	
End and intermediate plate, 1 mm/0.039 in thick		End and intermediate plate, 1 mm/0.039 in thick	
 orange 2010-1292 100 (4 x 25)		 orange 2010-1392 100 (4 x 25)	
 grey 2010-1291 100 (4 x 25)		 grey 2010-1391 100 (4 x 25)	
Push-in type jumper bars, light grey, insulated, I_N 57 A		Push-in type jumper bars, light grey, insulated, I_N 57 A	
  51 A		  50 A	
2-way 2010-402 50 (2 x 25)		2-way 2010-402 50 (2 x 25)	
3-way 2010-403 50 (2 x 25)		3-way 2010-403 50 (2 x 25)	
4-way 2010-404 50 (2 x 25)		4-way 2010-404 50 (2 x 25)	
5-way 2010-405 50 (2 x 25)		5-way 2010-405 50 (2 x 25)	
Push-in type jumper bars, light grey, insulated, I_N 57 A		Push-in type jumper bars, light grey, insulated, I_N 57 A	
  51 A		  50 A	
1 - 3 2010-433 50 (2 x 25)		1 - 3 2010-433 50 (2 x 25)	
1 - 4 2010-434 50 (2 x 25)		1 - 4 2010-434 50 (2 x 25)	
1 - 5 2010-435 50 (2 x 25)		1 - 5 2010-435 50 (2 x 25)	
Protective warning marker,		Protective warning marker,	
for 5 terminal blocks		for 5 terminal blocks	
 yellow 2010-115 100 (4 x 25)		 yellow 2010-115 100 (4 x 25)	
Test plug adapter, for test plug 4 mm/0.157 in Ø		Test plug adapter, for test plug 4 mm/0.157 in Ø	
 2009-174 100 (4 x 25)		 2009-174 100 (4 x 25)	
Testing tap, for max. 2.5 mm²		Testing tap, for max. 2.5 mm²	
 2009-182 100 (4 x 25)		 2009-182 100 (4 x 25)	
Marker strip, white, plain, on roll		Marker strip, white, plain, on roll	
for center marking		for center marking	
11 mm/0.039 in wide		11 mm/0.039 in wide	
50 m 2009-110 1		50 m 2009-110 1	
300 m 2009-130 1		300 m 2009-130 1	
Finger guard cover,		Finger guard cover,	
 serves as touchproof protection		 serves as touchproof protection	
for unused clamping units		for unused clamping units	
yellow 2010-100 100 (4 x 25)		yellow 2010-100 100 (4 x 25)	

Note:
The total current flowing cannot exceed the rating of the step-down jumper/push-in type jumper bar.



Finger guard cover snapped into unused clamping unit (Example: Series 2016)

* For further approvals with corresponding ratings see page 49.

TOPJOB[®] Rail-Mounted Terminal Blocks 16 (25 "f-st") mm²/AWG 4 Series 2016

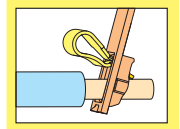

0.5 – 16 (25 "f-st") mm² ① AWG 20 – 4 800 V/8 kV/3 600 V, 85 A 76 A 600 V, 85 A Terminal block width 12 mm / 0.472 in 18 – 20 mm / 0.75 in *	0.5 – 16 (25 "f-st") mm² ① AWG 20 – 4 800 V/8 kV/3 600 V, 85 A 76 A 600 V, 85 A Terminal block width 12 mm / 0.472 in 18 – 20 mm / 0.75 in *	Commoning with step-down jumpers Application notes see page 7
--	--	--

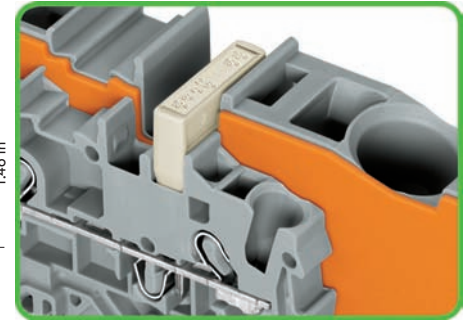
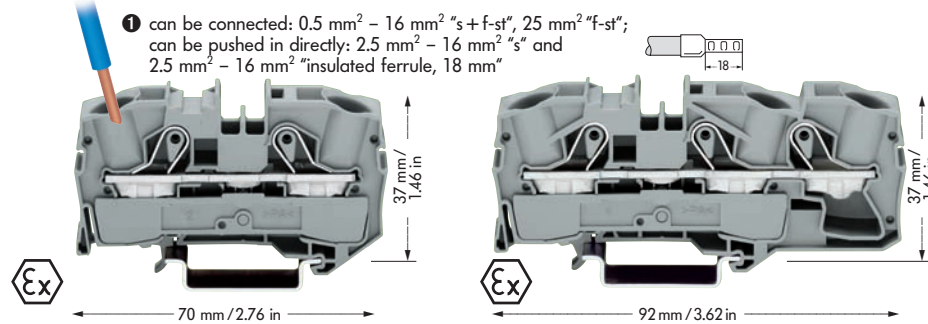

Item No.	Pack.-unit pcs	Item No.	Pack.-unit pcs	Item No.	Pack.-unit pcs
2-conductor through terminal blocks		3-conductor through terminal blocks		Commoning with step-down jumpers	
grey	2016-1201 ● 20	grey	2016-1301 ● 20	An end plate must always be used between the terminal blocks that are commoned with step-down jumpers.	
blue	2016-1204 ● 20	blue	2016-1304 ● 20	Step-down jumper 2006-499 is suitable for commoning	
orange	2016-1202 ● 20	orange	2016-1302 ● 20	AWG 10/12 (6/4 mm ²) terminal blocks with AWG	
2-conductor ground (earth) terminal block		3-conductor ground (earth) terminal block		12/14/16 (4/2.5/1.5 mm ²) terminal blocks.	
green-yellow	2016-1207 ● 20	green-yellow	2016-1307 ● 20	Step-down jumpers are simply pushed down to full insertion, in the same way as all other push-in type jumper bars.	
Suitable for Ex e II applications 550 V, 70 A		Suitable for Ex e II applications 550 V, 67 A			
② Suitable for Ex i applications		② Suitable for Ex i applications			



Accessories

appropriate marker system **WMB/Marker strips/WMB Inline** (see pages 38 to 39)

End and intermediate plate, 1 mm/0.039 in thick orange 2016-1292 100 (4 x 25) grey 2016-1291 100 (4 x 25)	End and intermediate plate, 1 mm/0.039 in thick orange 2016-1392 100 (4 x 25) grey 2016-1391 100 (4 x 25)	Step-down jumper, light grey, insulated 57 A 2016-499 50 (2 x 25)
Push-in type jumper bars, light grey, insulated, I_N 76 A 65 A 2-way 2016-402 50 (2 x 25) 3-way 2016-403 50 (2 x 25) 4-way 2016-404 50 (2 x 25) 5-way 2016-405 50 (2 x 25)	Push-in type jumper bars, light grey, insulated, I_N 76 A 65 A 2-way 2016-402 50 (2 x 25) 3-way 2016-403 50 (2 x 25) 4-way 2016-404 50 (2 x 25) 5-way 2016-405 50 (2 x 25)	Note: The total current flowing cannot exceed the rating of the step-down jumper/push-in type jumper bar.
Push-in type jumper bars, light grey, insulated, I_N 76 A 65 A 1 - 3 2016-433 50 (2 x 25) 1 - 4 2016-434 50 (2 x 25) 1 - 5 2016-435 50 (2 x 25)	Push-in type jumper bars, light grey, insulated, I_N 76 A 65 A 1 - 3 2016-433 50 (2 x 25) 1 - 4 2016-434 50 (2 x 25) 1 - 5 2016-435 50 (2 x 25)	
Protective warning marker, for 5 terminal blocks yellow 2016-115 50 (2 x 25)	Protective warning marker, for 5 terminal blocks yellow 2016-115 50 (2 x 25)	 Finger guard cover snapped into unused clamping unit
Test plug adapter, for test plug 4 mm/0.157 in Ø 2009-174 100 (4 x 25)	Test plug adapter, for test plug 4 mm/0.157 in Ø 2009-174 100 (4 x 25)	
Testing tap, for max. 2.5 mm² 2009-182 100 (4 x 25)	Testing tap, for max. 2.5 mm² 2009-182 100 (4 x 25)	
Marker strip, white, plain, on roll for center marking 11 mm / 0.039 in wide 50 m 2009-110 1 300 m 2009-130 1	Marker strip, white, plain, on roll for center marking 11 mm / 0.039 in wide 50 m 2009-110 1 300 m 2009-130 1	
Finger guard cover, serves as touchproof protection for unused clamping units yellow 2016-100 100 (4 x 25)	Finger guard cover, serves as touchproof protection for unused clamping units yellow 2016-100 100 (4 x 25)	

* For further approvals with corresponding ratings see page 49.

TOPJOB[®] 3- and 4-Conductor Rail-Mounted Terminal Blocks 2.5 (4) mm²/AWG 12 Series 2002

0.25 – 2.5 (4) mm² ① 800 V/8 kV/3 24 A Terminal block width 5.2 mm / 0.205 in  10 – 12 mm / 0.43 in	AWG 22 – 12 600 V	0.25 – 2.5 (4) mm² ① 800 V/8 kV/3 24 A Terminal block width 5.2 mm / 0.205 in  10 – 12 mm / 0.43 in	AWG 22 – 12 600 V
---	------------------------------------	--	------------------------------------

① can be connected: 0.25 mm² – 4 mm² "s+f-st";
can be pushed in directly: 0.75 mm² – 4 mm² "s" and
0.75 mm² – 2.5 mm² "insulated ferrules, 12 mm"

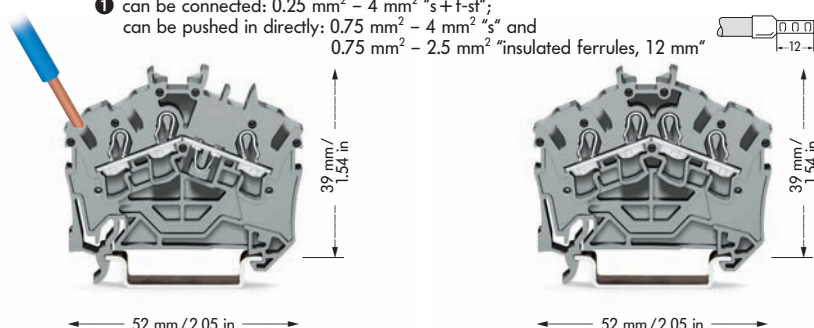

Item No.	Pack.-unit pcs	Item No.	Pack.-unit pcs
3-conductor through terminal blocks		4-conductor through terminal blocks	
grey 2002-6301 ●	100	grey 2002-6401 ●	100
blue 2002-6304 ●	100	blue 2002-6404 ●	100
orange 2002-6302 ●	100	orange 2002-6402 ●	100
more colors are being prepared		more colors are being prepared	
3-conductor ground (earth) terminal block		4-conductor ground (earth) terminal block	
green-yellow 2002-6307 ●	100	green-yellow 2002-6407 ●	100
Ex approvals in preparation		Ex approvals in preparation	
② Suitable for Ex i applications		② Suitable for Ex i applications	
		Attention!	
		These terminal blocks cannot be commoned!	
Accessories	appropriate marker system (see pages 38 to 39)	WMB/Marker strips/WMB Inline	
End and intermediate plate , 0.8 mm / 0.031 in thick		End and intermediate plate , 0.8 mm / 0.031 in thick	
orange 2002-6392 100 (4 x 25)		orange 2002-6392 100 (4 x 25)	
grey 2002-6391 100 (4 x 25)		grey 2002-6391 100 (4 x 25)	
Insulation stop , 5 pcs/strip		Insulation stop , 5 pcs/strip	
	200 strips		200 strips
light grey 2002-171 0.25-0.5 mm ²		light grey 2002-171 0.25-0.5 mm ²	
dark grey 2002-172 0.75-1 mm ²		dark grey 2002-172 0.75-1 mm ²	
Push-in type jumper bars , light grey, insulated, I _N 25 A			
2-way 2002-402 200 (8 x 25)			
3-way 2002-403 200 (8 x 25)			
4-way 2002-404 200 (8 x 25)			
5-way 2002-405 100 (4 x 25)			
:	:		
10-way 2002-410 100 (4 x 25)			
Push-in type jumper bars , light grey, insulated, I _N 25 A			
1 - 3 2002-433 200 (8 x 25)			
1 - 4 2002-434 200 (8 x 25)			
1 - 5 2002-435 100 (4 x 25)			
:	:		
1 - 10 2002-440 100 (4 x 25)			
Protective warning marker , for 5 terminal blocks		Protective warning marker , for 5 terminal blocks	
yellow 2002-115 100 (4 x 25)		yellow 2002-115 100 (4 x 25)	
Modular TOPJOB[®]S connector** , for jumper contact slot			
1 pole 2002-511 100 (4 x 25)			
Spacer , modular			
2002-549 100 (4 x 25)			
Test plug adapter , for test plug 4 mm/0.157 in Ø			
2009-174 100 (4 x 25)			
Testing tap , for max. 2.5 mm ²			
2009-182 100 (4 x 25)			

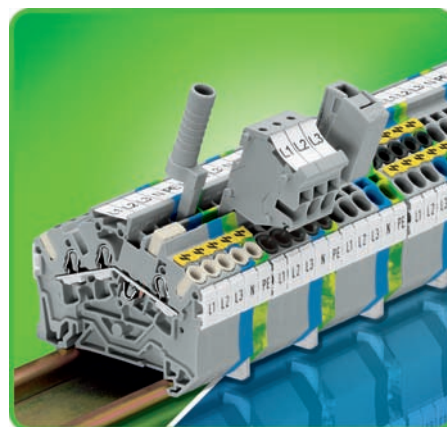

3- and 4-conductor terminal blocks

The new TOPJOB[®] rail-mounted terminal blocks have a conductor entry angle of 35 degrees allowing for a very small bend radius and an extremely short wiring distance to the cable duct. For applications in switchgear and control cabinets using the LSC wiring system from Lütze, for example, the new terminal blocks offer a space and cost saving solution. This way, conductors can be placed very close to the terminal blocks and their height can be kept relatively low.

Product characteristics



- CAGE CLAMP[®]S connection for all types of conductors, with the additional benefit that stripped solid wires and fine-stranded ferruled wires can be simply pushed in
- Vibration-proof, fast, maintenance-free connection
- 3-conductor through and ground (earth) conductor terminal blocks equipped with dual jumper slot
- 4-conductor terminal blocks allow for the multiplication of potentials without using any jumpers and any additional terminal blocks
- 3- and 4-conductor terminal blocks have the same dimensions

Test Plug Adapter and Testing Tap

Push-in type wire jumpers

Test plug adapter and testing tap for testing rail-mounted terminal blocks of Series 2001/2002/2004/2006/2010/2016	Push-in type wire jumper Nominal voltage: 800 V/8 kV/3 Nominal current: 16 A Rated cross section: 1.5 mm ² Wire lengths: 60/110/250 mm	
--	--	--

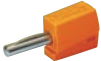

Item No.	Pack. unit pcs	Item No.	Pack.-unit pcs
Test plug adapter, for test plugs 4 mm/0.157 in Ø, for testing rail-mounted terminal blocks of Series 2001/2002/2004/2006/2010/2016 2009-174		Push-in type wire jumpers, insulated, conductor cross section 1.5 mm ² , suitable for rail-mounted terminal blocks of Series 2001 and 2002 Wire length 60 mm 2009-412	
	100 (4 x 25)		10
Testing tap, for connecting individual test wires of AWG 28 to 14 (0.08 mm ² – 2.5 mm ²) without tools 2009-182		110 mm 2009-414 250 mm 2009-416	
	100 (4 x 25)		10
Banana plugs, for sockets 4 mm/0.157 in Ø  see page 2.42			
Test plug, 4 mm/0.157 in Ø,  touch proof, not offered by WAGO for ex. mfd by Multi Contact Deutschland GmbH			
Application notes			

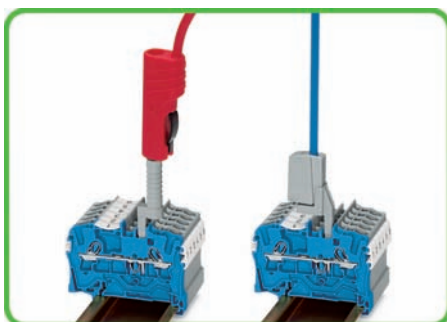

Testing TOPJOB®S rail-mounted terminal blocks using a test plug adapter or testing tap.

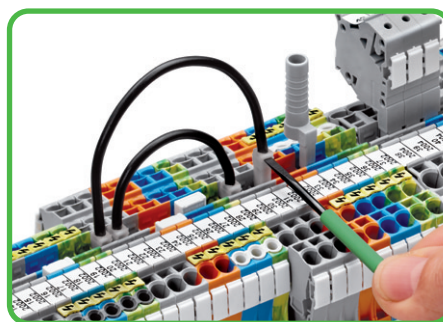



Push down the wire jumper until fully inserted. Lift the jumper with a screwdriver for rewiring.







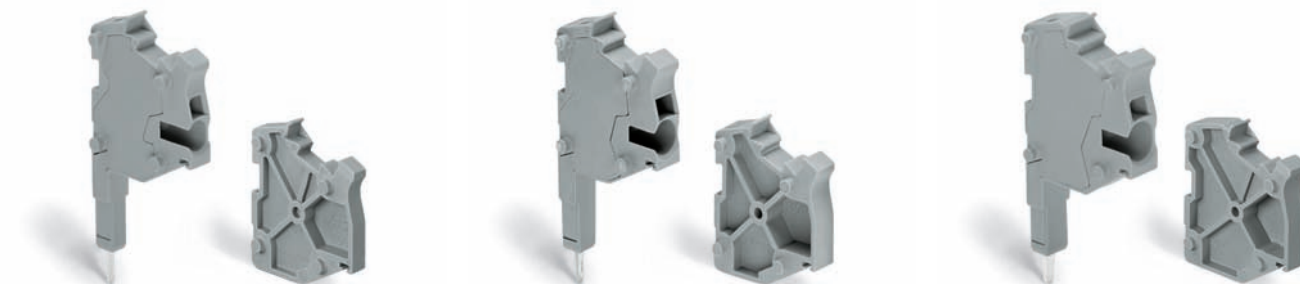

TOPJOB[®]S

Modular TOPJOB[®]S Connectors with CAGE CLAMP[®]S Connection

Series 2001/2002/2004

0.25 – 1.5 (2.5) mm² ① AWG 22 – 14 500 V/6 kV/3 18 A Terminal block width 4.2 mm / 0.165 in  9 – 11 mm / 0.39 in	0.25 – 2.5 (4) mm² ② AWG 22 – 12 500 V/6 kV/3 24 A Terminal block width 5.2 mm / 0.205 in  10 – 12 mm / 0.43 in	0.5 – 4 (6) mm² ③ AWG 20 – 10 500 V/6 kV/3 32 A Terminal block width 6.2 mm / 0.244 in  11 – 13 mm / 0.47 in
--	--	---



Item No.	Pack.-unit pcs	Item No.	Pack.-unit pcs	Item No.	Pack.-unit pcs
Modular TOPJOB[®]S connectors with CAGE CLAMP[®]S connection, modular, grey, 1 pole		Modular TOPJOB[®]S connectors with CAGE CLAMP[®]S connection, modular, grey, 1 pole		Modular TOPJOB[®]S connectors with CAGE CLAMP[®]S connection, modular, grey, 1 pole	
2001-511	100 (4 x 25)	2002-511	100 (4 x 25)	2004-511	100 (4 x 25)
Spacer, for bridging over commoned terminal blocks, for example, modular, grey		Spacer, for bridging over commoned terminal blocks, for example, modular, grey		Spacer, for bridging over commoned terminal blocks, for example, modular, grey	
2001-549	100 (4 x 25)	2002-549	100 (4 x 25)	2004-549	100 (4 x 25)
① can be connected: 0.25 mm ² – 2.5 mm ² "s + f-st"; can be pushed in directly: 0.5 mm ² – 2.5 mm ² "s" and 0.75 mm ² – 1.5 mm ² "Insulated ferrule, 12 mm"		② can be connected: 0.25 mm ² – 4 mm ² "s + f-st"; can be pushed in directly: 0.75 mm ² – 4 mm ² "s" and 0.75 mm ² – 2.5 mm ² "Insulated ferrules, 12 mm"		③ can be connected: 0.5 mm ² – 6 mm ² "s + f-st"; can be pushed in directly: 1 mm ² – 6 mm ² "s" and 0.75 mm ² – 4 mm ² "Insulated ferrule, 12 mm"	
Item-specific accessories		Item-specific accessories		Item-specific accessories	
End plate, 1.5 mm/0.059 in thick		End plate, 1.5 mm/0.059 in thick		End plate, 1.5 mm/0.059 in thick	
 grey	2002-541 100 (4 x 25)	 grey	2002-541 100 (4 x 25)	 grey	2002-541 100 (4 x 25)
WMB Multi marking card, 10 strips with 10 markers each, white with black printing, 4 – 4.2 mm/0.157 – 0.165 in wide		WMB Multi marking card, 10 strips with 10 markers each, white with black printing, 5 – 5.2 mm/0.197 – 0.205 in wide		WMB Multi marking card, 10 strips with 10 markers each, white with black printing, 5 – 5.2 mm/0.197 – 0.205 in wide	
 793-4 ...	5 cards	 793-5 ...	5 cards	 793-5 ...	5 cards
 794-4 ...	5 cards	 794-5 ...	5 cards	 794-5 ...	5 cards
see Full Line Catalog W4 volume 1, section 14		see Full Line Catalog W4 volume 1, section 14		see Full Line Catalog W4 volume 1, section 14	

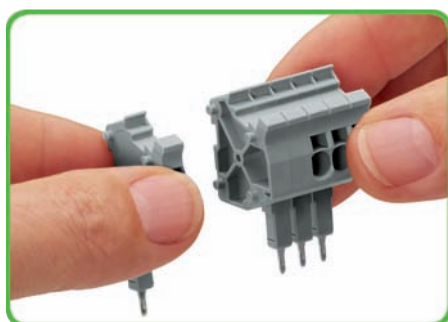



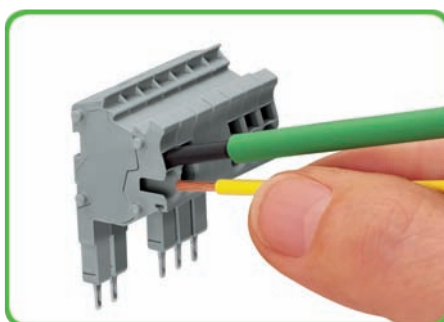

Snapping together of connectors and spacers to assemble a multi-pole connector

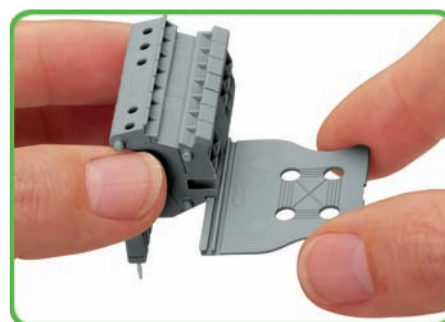

Wire connection: Screwdriver actuation for connection of all conductor types, i.e. stripped stranded conductors, or push-in connection of solid or ferruled stranded conductors.





Snapping on a strain relief plate

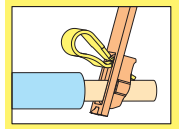

Accessories for TOPJOB [®] S connectors		appropriate marker system WMB/Marker strips (see Full Line Catalog W4 volume 1, section 14)	
 Test plug, with cable 500 mm/17.7"	2.3 mm/0.091 in Ø yellow 210-137 50 (5 x 10)	 Strain relief plate, grey	snappable onto connector strips
 Test plug, with cable 500 mm/17.7"	2 mm/0.079 in Ø red 210-136 50 (5 x 10)	 Marker strips, withe, plain, on roll	11 mm/0.039 in wide 50 m 2009-110 1
	6 mm/0.236 in wide 734-327 100 (4 x 25) 12.5 mm/0.492 in wide 734-328 100 (4 x 25) 25 mm/0.984 in wide 734-329 100 (4 x 25) 35 mm/1.378 in wide 734-326 100 (4 x 25)	 Marker strips, withe, plain, on roll	11 mm/0.039 in wide 300 m 2009-130 1

TOPJOB[®] Connector Strips with CAGE CLAMP[®]S Connection Series 2001/2002/2004

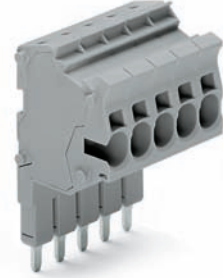
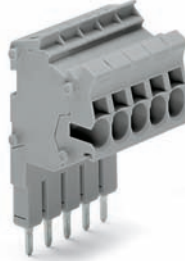

0.25 – 1.5 (2.5) mm² ⓪ AWG 22 – 14 500 V/6 kV/3 18 A Terminal block width 4.2 mm / 0.165 in  9 – 11 mm / 0.39 in	0.25 – 2.5 (4) mm² ⓪ AWG 22 – 12 500 V/6 kV/3 24 A Terminal block width 5.2 mm / 0.205 in  10 – 12 mm / 0.43 in	0.5 – 4 (6) mm² ⓪ AWG 20 – 10 500 V/6 kV/3 32 A Terminal block width 6.2 mm / 0.244 in  11 – 13 mm / 0.47 in
---	--	---



Item No.	Pack.-unit pcs	Item No.	Pack.-unit pcs	Item No.	Pack.-unit pcs
Modular TOPJOB[®]S connector strips with CAGE CLAMP[®]S connection, modular, grey,		Modular TOPJOB[®]S connector strips with CAGE CLAMP[®]S connection, modular, grey,		Modular TOPJOB[®]S connector strips with CAGE CLAMP[®]S connection, modular, grey,	
2-pole	2001-552	2-pole	2002-552	2-pole	2004-552
3-pole	2001-553	3-pole	2002-553	3-pole	2004-553
4-pole	2001-554	4-pole	2002-554	4-pole	2004-554
5-pole	2001-555	5-pole	2002-555	5-pole	2004-555
6-pole	2001-556	6-pole	2002-556		
7-pole	2001-557	7-pole	2002-557		
8-pole	2001-558	8-pole	2002-558		
9-pole	2001-559	9-pole	2002-559		
10-pole	2001-560	10-pole	2002-560		
⓪ can be connected: 0.25 mm ² – 2.5 mm ² "s + f-st"; can be pushed in directly: 0.5 mm ² – 2.5 mm ² "s" and 0.75 mm ² – 1.5 mm ² "Insulated ferrule, 12 mm"		⓪ can be connected: 0.25 mm ² – 4 mm ² "s + f-st"; can be pushed in directly: 0.75 mm ² – 4 mm ² "s" and 0.75 mm ² – 2.5 mm ² "Insulated ferrules, 12 mm"		⓪ can be connected: 0.5 mm ² – 6 mm ² "s + f-st"; can be pushed in directly: 1 mm ² – 6 mm ² "s" and 0.75 mm ² – 4 mm ² "Insulated ferrule, 12 mm"	
Item-specific accessories		Item-specific accessories		Item-specific accessories	
WMB Multi marking card, 10 strips with 10 markers each, white with black printing, 4 – 4.2 mm/0.157 - 0.165 in wide  793-4 . . . 5 cards 794-4 . . . 5 cards see Full Line Catalog W4 volume 1, section 14		WMB Multi marking card, 10 strips with 10 markers each, white with black printing, 5 – 5.2 mm/0.197 - 0.205 in wide  793-5 . . . 5 cards 794-5 . . . 5 cards see Full Line Catalog W4 volume 1, section 14		WMB Multi marking card, 10 strips with 10 markers each, white with black printing, 5 – 5.2 mm/0.197 - 0.205 in wide  793-5 . . . 5 cards 794-5 . . . 5 cards see Full Line Catalog W4 volume 1, section 14	

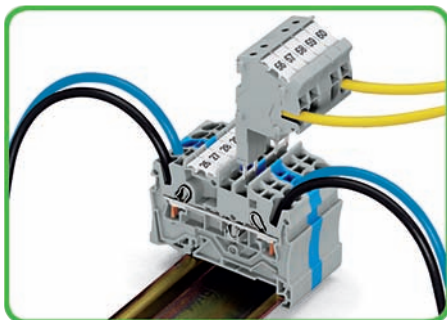

The modular connectors provide an additional connection option for conductors of the same cross section range as the terminal blocks being used.

Miniature WSB Quick marking card, 10 strips with 10 markers each, white with black printing, 5 mm /0.197 in wide 248- . . . 5 cards 249- . . . 5 cards see Full Line Catalog W4 volume 1, section 14

WMB Inline, pitch 5 mm/0.197 in, stretchable 5 mm – 5.2 mm/0.197 in – 0.205 in, on roll, 1,500 markers withe 2009-115 1

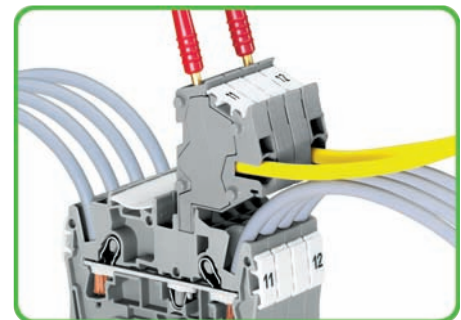



The connector has a test socket for 2 mm/0.079 in or 2.3 mm/0.091 in test plugs.

Accessories for TOPJOB [®] S connectors		appropriate marker system WMB/Marker strips (see Full Line Catalog W4 volume 1, section 14)	
Test plug, with cable 500 mm/177" 2.3 mm/0.091 in Ø yellow 210-137 50 (5 x 10)	Strain relief plate, grey snappable onto connector strips 	Marker strips, withe, plain, on roll 11 mm /0.039 in wide 50 m 2009-110 1	
Test plug, with cable 500 mm/177" 2 mm/0.079 in Ø red 210-136 50 (5 x 10)	6 mm /0.236 in wide 734-327 100 (4 x 25) 12.5 mm /0.492 in wide 734-328 100 (4 x 25) 25 mm /0.984 in wide 734-329 100 (4 x 25) 35 mm /1.378 in wide 734-326 100 (4 x 25)	Marker strips, withe, plain, on roll 11 mm /0.039 in wide 300 m 2009-130 1	

TOPJOB® S

Double Deck Terminal Blocks 2.5 (4) mm² / AWG 12

Series 2002

0.25 – 2.5 (4) mm² ① AWG 22 – 12 500 V/6 kV/3 24 A Terminal block width 5.2 mm / 0.205 in  10 – 12 mm / 0.43 in	0.25 – 2.5 (4) mm² ① AWG 22 – 12 500 V/6 kV/3 24 A Terminal block width 5.2 / 0.205 in  10 – 12 mm / 0.43 in
--	--

① can be connected: 0.25 mm² – 4 mm² "s + f-st";
 can be pushed in directly: 0.75 mm² – 4 mm² "s" and
 0.75 mm² – 2.5 mm² "insulated ferrule, 12 mm"

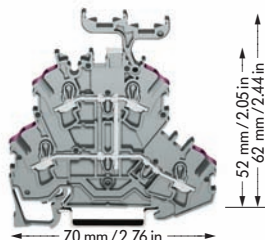
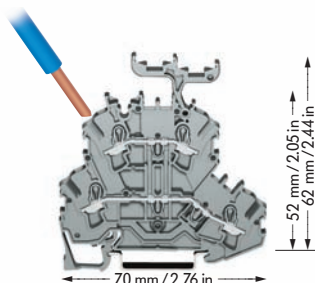
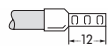

Item No.	Item No.	Pack.-unit pcs	Item No.	Item No.	Pack.-unit pcs
Double deck terminal blocks, for DIN 35 rail			Double deck terminal blocks, for DIN 35 rail		
Through-/through terminal blocks,			4-conductor through terminal block, internal commoning,		
housing color grey			housing color grey, conductor entry position colored in violet		
Marking carrier with		without	Marking carrier with		without
L/L	2002-2231	2002-2201 50	L	2002-2238	2002-2208 50
N/L	2002-2232	2002-2202 50	4-conductor through terminal block,		
L/N	2002-2233	2002-2203 50	internal commoning, housing color blue,		
Housing color blue			conductor entry position colored in violet		
N/N	2002-2234 ②	2002-2204 ② 50	N	2002-2239 ②	2002-2209 ② 50
ⓧ applications are being prepared			ⓧ applications are being prepared		
② Suitable for Ex i applications			② Suitable for Ex i applications		

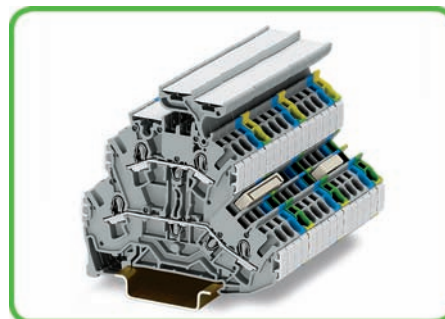



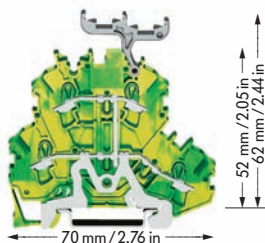
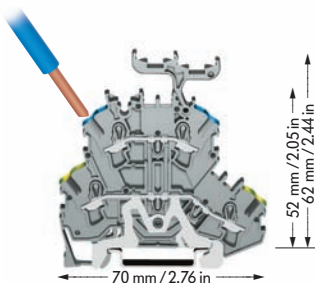
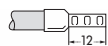



① can be connected: 0.25 mm² – 4 mm² "s + f-st";
 can be pushed in directly: 0.75 mm² – 4 mm² "s" and
 0.75 mm² – 2.5 mm² "insulated ferrule, 12 mm"



Item No.	Item No.	Pack.-unit pcs	Item No.	Item No.	Pack.-unit pcs	Item No.	Pack.-unit pcs
Double deck terminal blocks, for DIN 35 rail			Double deck terminal blocks, for DIN 35 rail				
Ground (earth) conductor/through terminal block,			4-conductor ground (earth) terminal block,				
Housing color grey			internal commoning				
Housing color green-yellow			Housing color green-yellow				
Marking carrier with		without	Marking carrier with		without		
PE/N	2002-2247	2002-2217 50	PE	2002-2237	2002-2207 50		
PE/L	2002-2257	2002-2227 50					
ⓧ applications are being prepared			ⓧ applications are being prepared				

Accessories

Appropriate marking system **WMB/marker strips/WMB Inline** (see page 38 to 39)

End and intermediate plate, 0.8 mm/0.032 in thick  orange 2002-2292 100 (4 x 25) grey 2002-2291 100 (4 x 25)	Two-way marking adapter,  pivotable 2002-121 50 (4 x 25)	Protective warning marker, with high voltage symbol, for 5 terminal blocks  yellow 2002-115 100 (4 x 25)
Push-in type jumper bars, light grey, insulated, I_N  2-way 2002-402 200 (8 x 25) 3-way 2002-403 200 (8 x 25) 4-way 2002-404 200 (8 x 25) 5-way 2002-405 100 (4 x 25) : : 10-way 2002-410 100 (4 x 25)	Push-in type jumper bars, light grey, insulated, I_N  1 - 3 2002-433 200 (8 x 25) 1 - 4 2002-434 200 (8 x 25) 1 - 5 2002-435 100 (4 x 25) : : 1 - 10 2002-440 100 (4 x 25)	Marker strips, white, plain, for central marking, 11 mm/0.433 in wide,  on roll 50 m 2009-110 1 300 m 2009-130 1 Insulation stop, see page 17

* For further approvals with corresponding ratings see page 49.

TOPJOB® Triple Deck Terminal Blocks 2.5 (4) mm² / AWG 12 Series 2002

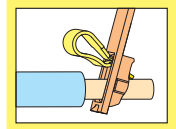

0.25 – 2.5 (4) mm ² ① AWG 22 – 12 500 V/6 kV/3 24 A Terminal block width 5.2 / 0.205 in 10 – 12 mm / 0.43 in *	0.25 – 2.5 (4) mm ² ① AWG 22 – 12 500 V/6 kV/3 24 A Terminal block width 5.2 mm / 0.205 in 10 – 12 mm / 0.43 in *	0.25 – 2.5 (4) mm ² ① AWG 22 – 12 500 V/6 kV/3 24 A Terminal block width 5.2 mm / 0.205 in 10 – 12 mm / 0.43 in *
--	---	---

① can be connected: 0.25 mm² – 4 mm² "s + f-st";
can be pushed in directly: 0.75 mm² – 4 mm² "s" and 0.75 mm² – 2.5 mm² "insulated ferrule, 12 mm"

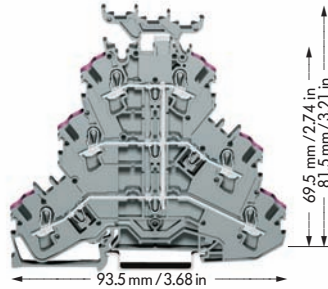
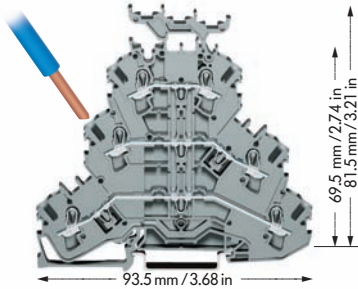

Item No.	Item No.	Pack.-unit pcs	Item No.	Item No.	Pack.-unit pcs
Triple deck terminal blocks, for DIN 35 rail			Triple deck terminal block, for DIN 35 rail		
Through-/through-/through terminal blocks,			6-conductor through terminal block, internal commoning,		
housing color grey			housing color grey, conductor entry position colored in violet		
Marking carrier with		without	Marking carrier with		without
L/L/L	2002-3231	2002-3201 50	L	2002-3238	2002-3208 50
L/L/N	2002-3233	2002-3203 50	6-conductor through terminal block,		
Housing color blue			internal commoning, housing color blue,		
N/N/N	2002-3234 ②	2002-3204 ② 50	N		2002-3239 ② 2002-3209 ② 50
⊗ applications are being prepared			⊗ applications are being prepared		
② Suitable for Ex i applications			② Suitable for Ex i applications		

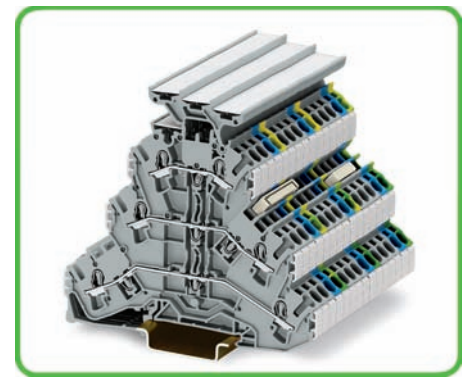

① can be connected: 0.25 mm² – 4 mm² "s + f-st";
can be pushed in directly: 0.75 mm² – 4 mm² "s" and 0.75 mm² – 2.5 mm² "insulated ferrule, 12 mm"

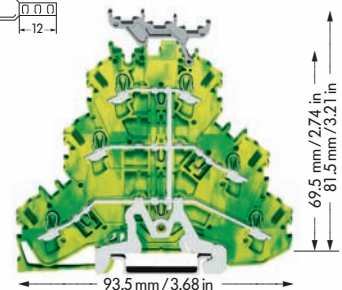
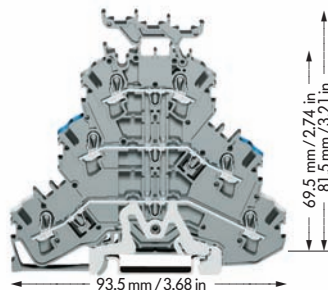
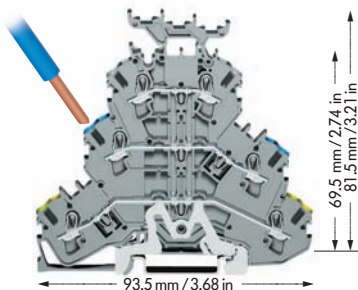

Item No.	Item No.	Pack.-unit pcs	Item No.	Item No.	Pack.-unit pcs	Item No.	Item No.	Pack.-unit pcs
Triple deck terminal blocks, for DIN 35 rail			Triple deck terminal block, for DIN 35 rail			Triple deck terminal block, for DIN 35 rail		
Ground (earth)/through/through terminal blocks,			Shield (screen)/through/through terminal blocks,			6-conductor ground (earth) terminal block,		
housing color grey			housing color grey			internal commoning		
Marking carrier with		without	Marking carrier with		without	Marking carrier with		without
PE/N/L	2002-3247	2002-3217 50	Schirm/N/L	2002-3248	2002-3218 50	PE	2002-3237	2002-3207 50
PE/L/L	2002-3257	2002-3227 50	Schirm/L/L	2002-3258	2002-3228 50			
⊗ applications are being prepared			⊗ applications are being prepared			⊗ applications are being prepared		

Accessories

Appropriate marking system **WMB/marker strips/WMB Inline** (see page 38 to 39)



End and intermediate plate, 0.8 mm/0.032 in thick orange 2002-3292 100 (4 x 25) grey 2002-3291 100 (4 x 25)	Two-way marking adapter, pivotable 2002-121 50 (4 x 25)	Protective warning marker, with high voltage symbol, for 5 terminal blocks yellow 2002-115 100 (4 x 25)
Push-in type jumper bars, light grey, insulated, I_N 2-way 2002-402 200 (8 x 25) 3-way 2002-403 200 (8 x 25) 4-way 2002-404 200 (8 x 25) 5-way 2002-405 100 (4 x 25) : 10-way 2002-410 100 (4 x 25)	Push-in type jumper bars, light grey, insulated, I_N 1 - 3 2002-433 200 (8 x 25) 1 - 4 2002-434 200 (8 x 25) 1 - 5 2002-435 100 (4 x 25) : 1 - 10 2002-440 100 (4 x 25)	Marker strips, white, plain, for central marking, 11 mm/0.433 in wide, on roll 50 m 2009-110 1 300 m 2009-130 1
Insulation stop, see page 17		

* For further approvals with corresponding ratings see page 49.

TOPJOB[®]S

Multilevel Installation Terminal Blocks 4 mm²/AWG 12

Series 2003

0.25 – 2.5 (4) mm² ① AWG 22 – 12 250 V/4 kV ②/3 400 V/6 kV ③/3 32 A Terminal block width 5.2 mm / 0.205 in  10 – 12 mm / 0.43 in	0.25 – 2.5 (4) mm² ① AWG 22 – 12 400 V/6 kV/3 32 A Terminal block width 5.2 mm / 0.205 in  10 – 12 mm / 0.43 in	Accessories for 2003 Series multilevel installation terminal blocks and 2002/2006/2016 Series N-conductor disconnect terminal blocks
--	---	---

① can be connected: 0.25 mm² – 4 mm² "s + f-st";
 can be pushed in directly: 0.75 mm² – 4 mm² "s" and
 0.75 mm² – 2.5 mm² "insulated ferrule, 12 mm" 

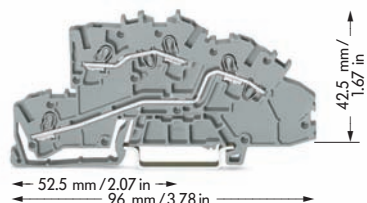
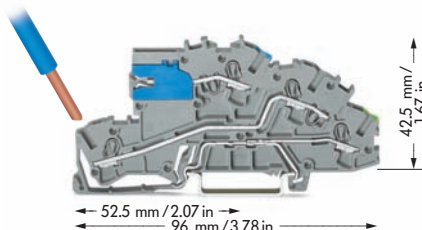

Item No.	Pack.-unit pcs	Item No.	Pack.-unit pcs
Multilevel installation terminal block, grey with N-disconnect slide link		Multilevel installation terminal blocks, grey	
NT/L/PE	2003-7641	L/L	2003-7642
	50	N/L	2003-7649
			50

② Potential-Ground ③ Potential-Potential

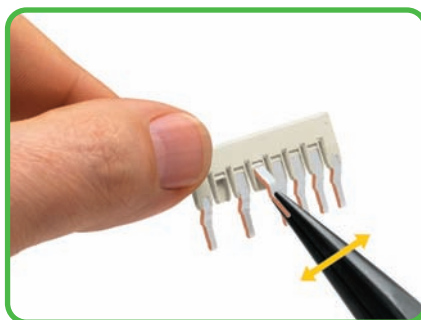
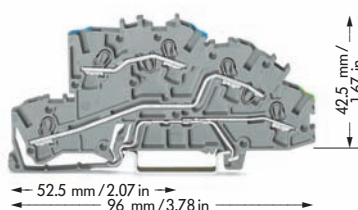

Staggered jumper with 7 contacts
 Breaking off contact lugs

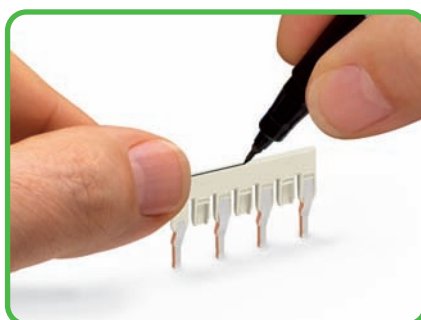

Staggered jumper 1 – 3 – 5 – 7
 Marking with a felt tip pen



Two staggered jumpers 1 – 3 – 5 – 7
 staggered for use in a jumper slot



Locate red stripes of the staggered jumpers on the inside

	Item No.	Pack.-unit pcs
End and intermediate plate, 1 mm / 0.039 in thick orange	2003-7692	100 (4 x 25)
Busbar carrier, for DIN rail 35 (not suitable for use as end stop)		
1.5 mm / 0.059 in thick blue	2009-304	100 (4 x 25)
Busbar carrier with end stop function and detachable separator plate, for DIN rail 35; 7.5 mm / 0.295 in thick		
blue	2009-305	25
N-busbar, tinned		
Copper 10 mm x 3 mm, I _N 140 A, 1000 mm / 39.37 in long	210-133	1
Cover for N-busbar		
transparent 1000 mm / 39.37 in long	777-303	1
Neutral supply terminal block, I_N 76 A, 16 mm², blue 12 mm wide	2016-7114	25
Ground (earth) supply terminal block, I_N 76 A, 16 mm², green-yellow, 12mm wide	2016-1207	20
Connector, with blue cover, for N-busbar 2.5 mm² – 16 mm²	210-281	100 (2 x 50)
Connector, uninsulated, for N-busbar 2.5 mm² – 35 mm²	209-105	50 (2 x 25)
Push-in type jumper bars, light grey, insulated, I_N 25 A		
2-way	2002-402	200 (8 x 25)
3-way	2002-403	200 (8 x 25)
4-way	2002-404	200 (8 x 25)
5-way	2002-405	100 (4 x 25)
:	:	:
10-way	2002-410	100 (4 x 25)
Push-in type jumper bars, light grey, insulated, I_N 25 A		
1 - 3	2002-433	200 (8 x 25)
1 - 4	2002-434	200 (8 x 25)
1 - 5	2002-435	100 (4 x 25)
:	:	:
1 - 10	2002-440	100 (4 x 25)
Staggered jumper, light grey, insulated, I_N 25 A		
2-way	2002-472	100 (4 x 25)
3-way	2002-473	100 (4 x 25)
4-way	2002-474	100 (4 x 25)
5-way	2002-475	50 (2 x 25)
:	:	:
12-way	2002-482	50 (2 x 25)
Test plug, 2 mm / 0.079 in Ø	210-136	50 (5 x 10)
Test plug adapter, for test plug 4 mm / 0.157 in Ø	2009-174	100 (4 x 25)
Testing tap, for max. 2.5 mm²	2009-182	100 (4 x 25)

Examples of circuit configuration with staggered jumpers see page 48

N-Disconnect Terminal Blocks and Power Distribution Disconnect Terminal Blocks Series 2002, 2006 and 2016

<p>0.25 – 2.5 (4) mm² ① AWG 22 – 12 250 V/4 kV/3 32 A</p> <p>Terminal block width 5.2 mm / 0.205 in 10 – 12 mm / 0.43 in</p>	<p>0.5 – 6 (10) mm² ① AWG 20 – 8 250 V/4 kV/3 51 A</p> <p>Terminal block width 7,5 mm / 0.295 in 13 – 15 mm / 0.55 in</p>	<p>0.5 – 16 (25 "f") mm² ① AWG 20 – 4 250 V/4 kV/3 76 A</p> <p>Terminal block width 12 mm / 0.472 in 18 – 20 mm / 0.75 in</p>
---	--	--

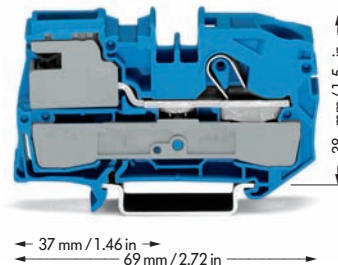
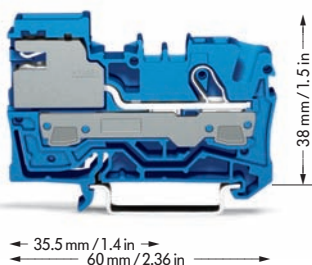
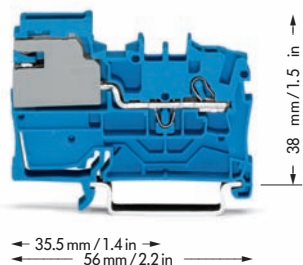

Item No.	Pack.-unit pcs	Item No.	Pack.-unit pcs	Item No.	Pack.-unit pcs
1-conductor N-disconnect terminal block		1-conductor N-disconnect terminal block		1-conductor N-disconnect terminal block	
blue	2002-7114 ②	50	blue	2006-7114 ②	50
1-conductor power distribution disconnect terminal block		1-conductor power distribution disconnect terminal block		1-conductor power distribution disconnect terminal block	
grey	2002-7111 ③	50	grey	2006-7111 ③	50
End and intermediate plate, 0.8 mm / 0.031 in thick		End and intermediate plate, 1 mm / 0.039 in thick		End and intermediate plate, 1 mm / 0.039 in thick	
orange	2002-7192	100 (4 x 25)	orange	2006-7192	100 (4 x 25)
For appropriate through and earth conductor terminal blocks see page 17		For appropriate through and earth conductor terminal blocks see page 17		For appropriate through and earth conductor terminal blocks see page 17	

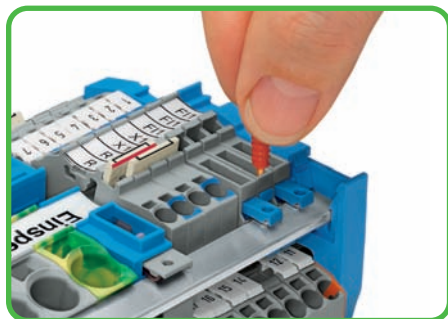

Testing with test plug Ø 2 mm



Operation of the slide link using a simple screwdriver

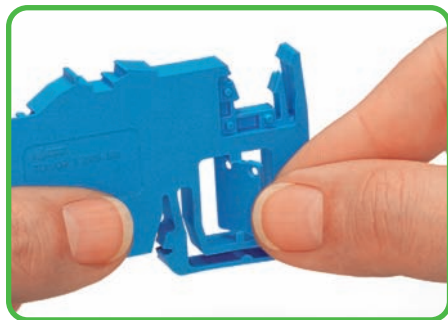

Removing the separator plate from the busbar carrier.

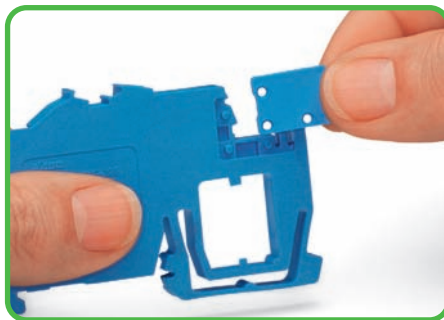

Insertion of the separator plate. To protect the N-busbar against accidental contact

① see also appropriate through terminal blocks

② For the construction and operation of power installations in fire hazardous locations or public buildings, such as meeting places, stores, hospitals, schools, theaters, hotels etc., the VDE 0100 or VDE 0108-1 standards must be observed. VDE 0100-482 must be observed for fire hazardous locations. Both VDE regulations determine that insulation testing must be possible for every circuit without disconnecting the N-conductor.

WAGO N-disconnect terminal blocks meet this requirement.

③ According to VDE 0107 "Installing and testing electrical installations in medical locations", the equipotential bonding conductors must be connected to a potential equalization busbar. The potential equalization busbar and the protective earth conductor busbar must be accommodated in a common housing and be connected by means of a disconnectable connection using a copper conductor with a minimum cross section of 16 mm². Furthermore, all equipotential bonding conductors must be connected to the potential equalization busbar in such a way that they are clearly arranged, that they can be disconnected individually and accessed at any time and, depending on their function, they must be provided with captive marking. The WAGO power distribution disconnect terminal blocks meet these requirements.

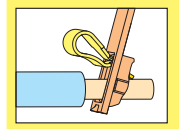

<p>0.25 – 2.5 (4) mm² ① AWG 22 – 12 400 V/6 kV/3 16 A</p> <p>Terminal block width 5.2 mm / 0.205 in 10 – 12 mm / 0.43 in</p>	<p>0.25 – 2.5 (4) mm² ① AWG 22 – 12 400 V/6 kV/3 16 A</p> <p>Terminal block width 5.2 mm / 0.205 in 10 – 12 mm / 0.43 in</p>
---	---

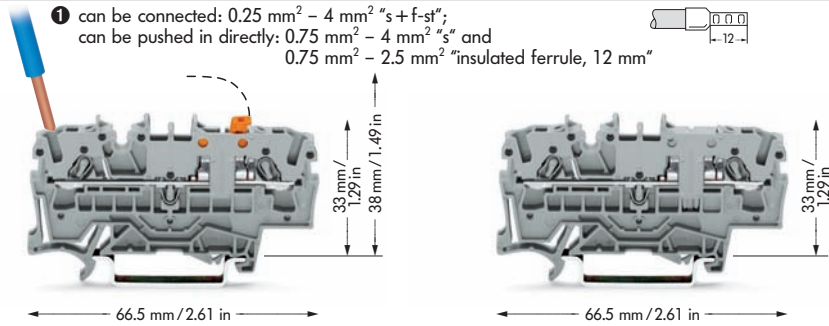

available August 2006

Item No.	Pack.-unit pcs	Item No.	Pack.-unit pcs
2-conductor disconnect terminal block for test and measurement		2-conductor through terminal blocks, same profile as disconnect terminal block	
grey	2002-1671 100 (4 x 25)	grey	2002-1601 100 (4 x 25)
blue	2002-1674 100 (4 x 25)	blue	2002-1604 100 (4 x 25)
orange	2002-1672 100 (4 x 25)	orange	2002-1602 100 (4 x 25)

Item-specific accessories

<p>End and intermediate plate, 1 mm / 0.039 in thick</p> <p>orange 2002-1692 100 (4 x 25) grey 2002-1691 100 (4 x 25)</p>	<p>End and intermediate plate, 1 mm / 0.039 in thick</p> <p>orange 2002-1692 100 (4 x 25) grey 2002-1691 100 (4 x 25)</p>
--	--



Accessories Series 2002

appropriate marker system **WMB/Marker strips/WMB Inline** (see pages 38 to 39)

<p>Insulation stop, 5 pcs/strip 200 strips</p> <p>light grey 2002-171 0.25-0.5 mm² dark grey 2002-172 0.75-1 mm²</p>	<p>Protective warning marker, for 5 terminal blocks yellow 2002-115 100 (4 x 25)</p>
<p>Push-in type jumper bars, light grey, insulated, I_N 25 A</p> <p>2-way 2002-402 200 (8 x 25) 3-way 2002-403 200 (8 x 25) 4-way 2002-404 200 (8 x 25) 5-way 2002-405 100 (4 x 25) : 10-way 2002-410 100 (4 x 25)</p>	<p>Staggered jumper, light grey, insulated, I_N 25 A</p> <p>2-way 2002-472 100 (4 x 25) 3-way 2002-473 100 (4 x 25) 4-way 2002-474 100 (4 x 25) 5-way 2002-475 50 (2 x 25) : 12-way 2002-482 50 (2 x 25)</p>
<p>Push-in type jumper bars, light grey, insulated, I_N 25 A</p> <p>1 - 3 2002-433 200 (8 x 25) 1 - 4 2002-434 200 (8 x 25) 1 - 5 2002-435 100 (4 x 25) : 1 - 10 2002-440 100 (4 x 25)</p>	<p>Test plug adapter, for test plug 4 mm / 0.157 in Ø 2009-174 100 (4 x 25)</p>
<p>Modular TOPJOB®S connector**, for jumper contact slot 1 pole 2002-511 100 (4 x 25)</p>	<p>Testing tap, for max. 2.5 mm² 2009-182 100 (4 x 25)</p>
<p>Spacer, modular 2002-549 100 (4 x 25)</p>	<p>Two-way marking adapter, pivotable 2002-121 50 (4 x 25)</p>
<p>Test plug, with cable 500 mm / 17.7" 2 mm / 0.079 in Ø red 210-136 50 (5 x 10)</p>	





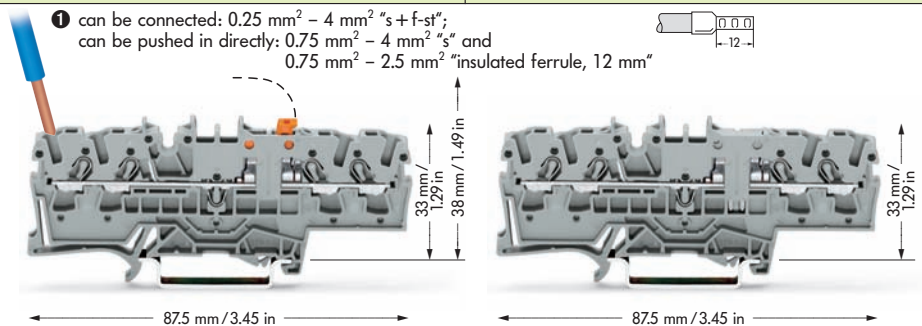

TOPJOB®S

Disconnect Terminal Blocks for Test and Measurement with Movable Knife Disconnect and Through Terminal Blocks, Series 2002



0.25 – 2.5 (4) mm² ① AWG 22 – 12 400 V/6 kV/3 16 A Terminal block width 5.2 mm / 0.205 in  10 – 12 mm / 0.43 in	0.25 – 2.5 (4) mm² ① AWG 22 – 12 400 V/6 kV/3 16 A Terminal block width 5.2 mm / 0.205 in  10 – 12 mm / 0.43 in
---	--



available
August 2006









Item No.	Pack.-unit pcs	Item No.	Pack.-unit pcs
4-conductor disconnect terminal block for test and measurement		4-conductor through terminal blocks, same profile as disconnect terminal block	
grey	2002-1871 	grey	2002-1801 
blue	2002-1874 	blue	2002-1804 
orange	2002-1872 	orange	2002-1802 

Item-specific accessories

End and intermediate plate, 1 mm / 0.039 in thick  orange 2002-1892 100 (4 x 25) grey 2002-1891 100 (4 x 25)	End and intermediate plate, 1 mm / 0.039 in thick  orange 2002-1892 100 (4 x 25) grey 2002-1891 100 (4 x 25)
---	--

Accessories Series 2002

appropriate marker system **WMB/Marker strips/WMB Inline** (see pages 38 to 39)

Insulation stop, 5 pcs/strip 200 strips  light grey 2002-171 0.25-0.5 mm ² dark grey 2002-172 0.75-1 mm ²	Protective warning marker, for 5 terminal blocks yellow 2002-115 100 (4 x 25)
Push-in type jumper bars, light grey, insulated, I_N 25 A  2-way 2002-402 200 (8 x 25) 3-way 2002-403 200 (8 x 25) 4-way 2002-404 200 (8 x 25) 5-way 2002-405 100 (4 x 25) : : 10-way 2002-410 100 (4 x 25)	Staggered jumper, light grey, insulated, I_N 25 A  2-way 2002-472 100 (4 x 25) 3-way 2002-473 100 (4 x 25) 4-way 2002-474 100 (4 x 25) 5-way 2002-475 50 (2 x 25) : : 12-way 2002-482 50 (2 x 25)
Push-in type jumper bars, light grey, insulated, I_N 25 A  1 - 3 2002-433 200 (8 x 25) 1 - 4 2002-434 200 (8 x 25) 1 - 5 2002-435 100 (4 x 25) : : 1 - 10 2002-440 100 (4 x 25)	Test plug adapter, for test plug 4 mm / 0.157 in Ø  2009-174 100 (4 x 25)
Modular TOPJOB®S connector**, for jumper contact slot  1 pole 2002-511 100 (4 x 25)	Testing tap, for max. 2.5 mm² 2009-182 100 (4 x 25)
Spacer, modular 2002-549 100 (4 x 25)	Two-way marking adapter, pivotable  2002-121 50 (4 x 25)
Test plug, with cable 500 mm / 17.7"  2 mm / 0.079 in Ø red 210-136 50 (5 x 10)	

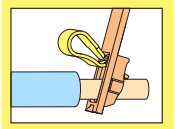

<p>0.25 – 2.5 (4) mm² ① AWG 22 – 12 400 V/6 kV/3 16 A</p> <p>Terminal block width 5.2 mm / 0.205 in 10 – 12 mm / 0.43 in</p>	<p>0.25 – 2.5 (4) mm² ① AWG 22 – 12 400 V/6 kV/3 16 A</p> <p>Terminal block width 5.2 mm / 0.205 in 10 – 12 mm / 0.43 in</p>	<p>0.25 – 2.5 (4) mm² ① AWG 22 – 12 400 V/6 kV/3 16 A</p> <p>Terminal block width 5.2 mm / 0.205 in 10 – 12 mm / 0.43 in</p>
---	---	---

① can be connected: 0.25 mm² – 4 mm² "s + f-st";
can be pushed in directly: 0.75 mm² – 4 mm² "s" and 0.75 mm² – 2.5 mm² "insulated ferrule, 12 mm"

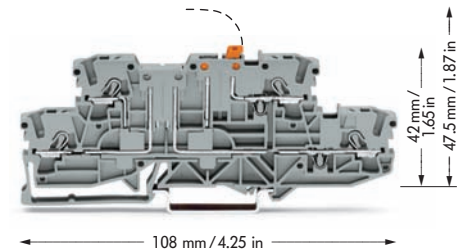
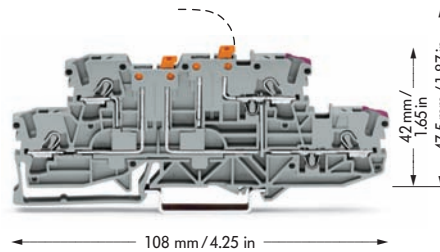
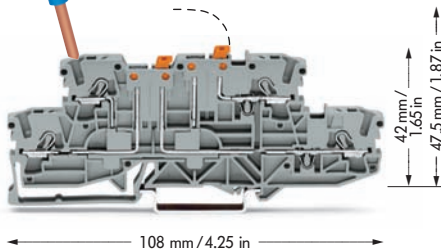

Item No.	Pack.-unit pcs	Item No.	Pack.-unit pcs	Item No.	Pack.-unit pcs
4-conductor double deck double disconnect terminal blocks		4-conductor double deck double disconnect terminal blocks, lower deck and upper deck internally commoned on right side and with violet marking		4-conductor double deck double disconnect terminal blocks, with disconnect on upper deck only, same profile as double deck double disconnect terminal blocks	
grey	2002-2951 ●	grey	2002-2958 ●	grey	2002-2971 ●
blue	2002-2954 ●	blue	2002-2959 ●	blue	2002-2974 ●
grey N/L	2002-2952 ●			grey N/L	2002-2972 ●

Item-specific accessories



<p>End and intermediate plate, 1 mm / 0.039 in thick</p> <p>orange 2002-2992 100 (4 x 25) grey 2002-2991 100 (4 x 25)</p>	<p>End and intermediate plate, 1 mm / 0.039 in thick</p> <p>orange 2002-2992 100 (4 x 25) grey 2002-2991 100 (4 x 25)</p>	<p>End and intermediate plate, 1 mm / 0.039 in thick</p> <p>orange 2002-2992 100 (4 x 25) grey 2002-2991 100 (4 x 25)</p>
--	--	--

Accessories Series 2002

appropriate marker system **WMB/Marker strips/WMB Inline** (see pages 38 to 39)

<p>Insulation stop, 5 pcs/strip 200 strips</p> <p>light grey 2002-171 0.25-0.5 mm² dark grey 2002-172 0.75-1 mm²</p>	<p>Protective warning marker, for 5 terminal blocks yellow 2002-115 100 (4 x 25)</p>	<p>Test plug, with cable 500 mm / 17.7" 2 mm / 0.079 in Ø red 210-136 50 (5 x 10)</p>
<p>Push-in type jumper bars, light grey, insulated, I_N 25 A</p> <p>2-way 2002-402 200 (8 x 25) 3-way 2002-403 200 (8 x 25) 4-way 2002-404 200 (8 x 25) 5-way 2002-405 100 (4 x 25) : : 10-way 2002-410 100 (4 x 25)</p>	<p>Push-in type jumper bars, light grey, insulated, I_N 25 A</p> <p>1 - 3 2002-433 200 (8 x 25) 1 - 4 2002-434 200 (8 x 25) 1 - 5 2002-435 100 (4 x 25) : : 1 - 10 2002-440 100 (4 x 25)</p>	<p>Staggered jumper, light grey, insulated, I_N 25 A</p> <p>2-way 2002-472 100 (4 x 25) 3-way 2002-473 100 (4 x 25) 4-way 2002-474 100 (4 x 25) 5-way 2002-475 50 (2 x 25) : : 12-way 2002-482 50 (2 x 25)</p>
<p>Modular TOPJOB®S connector**, for jumper contact slot 1 pole 2002-511 100 (4 x 25)</p>	<p>Test plug adapter, for test plug 4 mm / 0.157 in Ø 2009-174 100 (4 x 25)</p>	
<p>Spacer, modular 2002-549 100 (4 x 25)</p>	<p>Testing tap, for max. 2.5 mm² 2009-182 100 (4 x 25)</p>	

Double Deck Diode Terminal Blocks / Double Deck LED Terminal Blocks
2.5 mm²/4 mm² / AWG 12, Series 2002

<p>0.25 – 2.5 (4) mm² ① AWG 22 – 12 U_N 250 V; U_{RM} 1000 V 1 N 4007 – 0.5 A continuous current</p> <p>Terminal block width 5.2 mm / 0.205 in  10 – 12 mm / 0.43 in</p>	<p>0.25 – 2.5 (4) mm² ① AWG 22 – 12 U_N 250 V; U_{RM} 1000 V 1 N 4007 – 0.5 A continuous current</p> <p>Terminal block width 5.2 mm / 0.205 in  10 – 12 mm / 0.43 in</p>
---	---

① can be connected: 0.25 mm² – 4 mm² "s+f-st";
can be pushed in directly: 0.75 mm² – 4 mm² "s" and
0.75 mm² – 2.5 mm² "insulated ferrule, 12 mm"

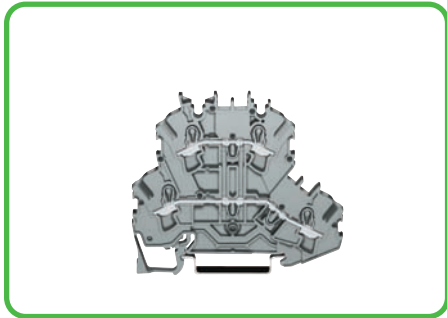
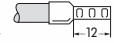



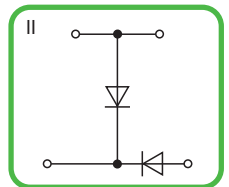
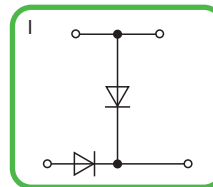
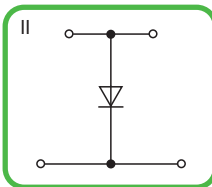
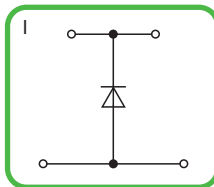
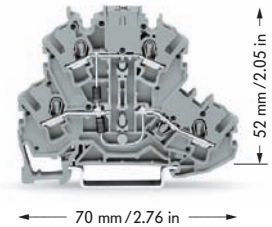
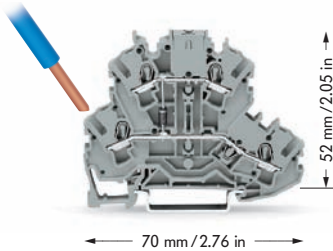

Through terminal blocks with the same shape see page 26



Description	Item No.	Pack. unit pcs	Item No.	Pack. unit pcs
Double deck diode terminal block and double deck LED terminal block, for DIN 35 rail	Double deck diode terminal blocks with diode 1 N 4007		Double deck diode terminal blocks with 2 diodes 1 N 4007	
	Circuit I, grey	2002-2211/1000-0410 50	Circuit I, grey	2002-2214/1000-0492 50
	Circuit II, grey	2002-2211/1000-0411 50	Circuit II, grey	2002-2214/1000-0491 50

Accessories

Appropriate marking system **WMB/WMB Inline** (see pages 38 to 39)

	End and intermediate plate	0.8 mm / 0.031 in thick		0.8 mm / 0.031 in thick	
	orange	2002-2292 100 (4 x 25)	orange	2002-2292 100 (4 x 25)	
	grey	2002-2291 100 (4 x 25)	grey	2002-2291 100 (4 x 25)	
	Push-in type jumper bars, light grey, insulated, I _N 25 A	2-way 2002-402 200 (8 x 25)	2-way 2002-402 200 (8 x 25)	2-way 2002-402 200 (8 x 25)	
		3-way 2002-403 200 (8 x 25)	3-way 2002-403 200 (8 x 25)	3-way 2002-403 200 (8 x 25)	
		4-way 2002-404 200 (8 x 25)	4-way 2002-404 200 (8 x 25)	4-way 2002-404 200 (8 x 25)	
		5-way 2002-405 100 (4 x 25)	5-way 2002-405 100 (4 x 25)	5-way 2002-405 100 (4 x 25)	
		:	:	:	:
		10-way 2002-410 100 (4 x 25)	10-way 2002-410 100 (4 x 25)	10-way 2002-410 100 (4 x 25)	
	Push-in type jumper bars, light grey, insulated, I _N 25 A	1 - 3 2002-433 200 (8 x 25)	1 - 3 2002-433 200 (8 x 25)	1 - 3 2002-433 200 (8 x 25)	
		1 - 4 2002-434 200 (8 x 25)	1 - 4 2002-434 200 (8 x 25)	1 - 4 2002-434 200 (8 x 25)	
		1 - 5 2002-435 100 (4 x 25)	1 - 5 2002-435 100 (4 x 25)	1 - 5 2002-435 100 (4 x 25)	
		:	:	:	:
		1 - 10 2002-440 100 (4 x 25)	1 - 10 2002-440 100 (4 x 25)	1 - 10 2002-440 100 (4 x 25)	
	Two-way marking adapter, pivotable	2002-121 50 (2 x 25)	2002-121 50 (2 x 25)	2002-121 50 (2 x 25)	

Examples of circuit configuration

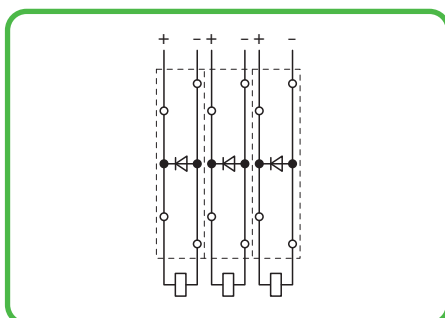

Used as recovery diodes

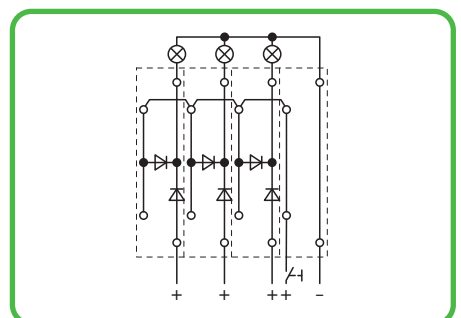

Used in lamp test circuit

available
July 2006

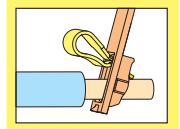

<p>0.25 – 2.5 (4) mm² ① AWG 22 – 12 U_N 250 V; U_{RM} 1000 V 1 N 4007 – 0.5 A continuous current</p> <p>Terminal block width 5.2 mm / 0.205 in 10 – 12 mm / 0.43 in</p>	<p>0.25 – 2.5 (4) mm² ① AWG 22 – 12 U_N 250 V; U_{RM} 1000 V 1 N 4007 – 0.5 A continuous current</p> <p>Terminal block width 5.2 mm / 0.205 in 10 – 12 mm / 0.43 in</p>	<p>0.25 – 2.5 (4) mm² ① AWG 22 – 12 DC 24 V I_f 25 mA max.</p> <p>Terminal block width 5.2 mm / 0.205 in 10 – 12 mm / 0.43 in</p>
--	--	---

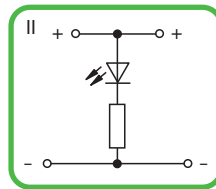
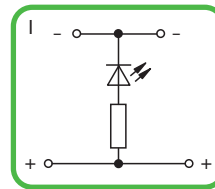
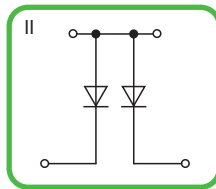
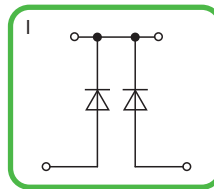
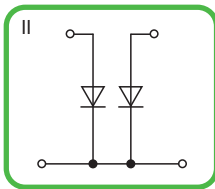
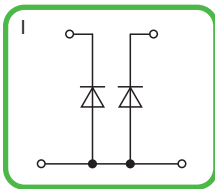
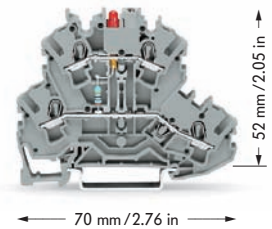
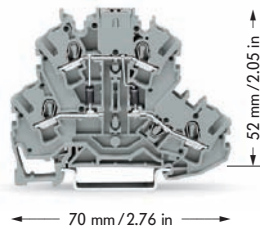
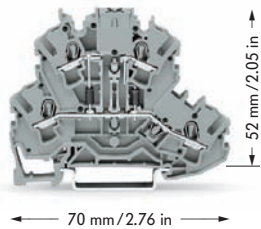

Item No.	Pack. unit pcs	Item No.	Pack. unit pcs	Item No.	Pack. unit pcs
Double deck diode terminal blocks with 2 diodes 1 N 4007		Double deck diode terminal blocks with 2 diodes 1 N 4007		Double deck LED terminal blocks with red LED, DC 24 V	
Circuit I, grey	2002-2213/1000-0487 50	Circuit I, grey	2002-2214/1000-0489 50	Circuit I, grey	2002-2221/1000-0434 50
Circuit II, grey	2002-2213/1000-0488 50	Circuit II, grey	2002-2214/1000-0490 50	Circuit II, grey	2002-2221/1000-0413 50

Appropriate marking system **WMB/WMB Inline** (see pages 38 to 39)

0.8 mm / 0.031 in thick			0.8 mm / 0.031 in thick			0.8 mm / 0.031 in thick		
orange	2002-2292	100 (4 x 25)	orange	2002-2292	100 (4 x 25)	orange	2002-2292	100 (4 x 25)
grey	2002-2291	100 (4 x 25)	grey	2002-2291	100 (4 x 25)	grey	2002-2291	100 (4 x 25)
2-way	2002-402	200 (8 x 25)	2-way	2002-402	200 (8 x 25)	2-way	2002-402	200 (8 x 25)
3-way	2002-403	200 (8 x 25)	3-way	2002-403	200 (8 x 25)	3-way	2002-403	200 (8 x 25)
4-way	2002-404	200 (8 x 25)	4-way	2002-404	200 (8 x 25)	4-way	2002-404	200 (8 x 25)
5-way	2002-405	100 (4 x 25)	5-way	2002-405	100 (4 x 25)	5-way	2002-405	100 (4 x 25)
:	:		:	:		:	:	
10-way	2002-410	100 (4 x 25)	10-way	2002-410	100 (4 x 25)	10-way	2002-410	100 (4 x 25)
1 - 3	2002-433	200 (8 x 25)	1 - 3	2002-433	200 (8 x 25)	1 - 3	2002-433	200 (8 x 25)
1 - 4	2002-434	200 (8 x 25)	1 - 4	2002-434	200 (8 x 25)	1 - 4	2002-434	200 (8 x 25)
1 - 5	2002-435	100 (4 x 25)	1 - 5	2002-435	100 (4 x 25)	1 - 5	2002-435	100 (4 x 25)
:	:		:	:		:	:	
1 - 10	2002-440	100 (4 x 25)	1 - 10	2002-440	100 (4 x 25)	1 - 10	2002-440	100 (4 x 25)
	2002-121	50 (2 x 25)		2002-121	50 (2 x 25)		2002-121	50 (2 x 25)

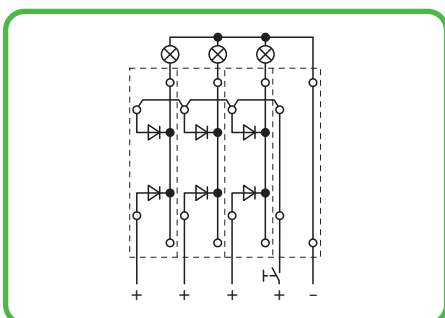

Used in lamp test circuit

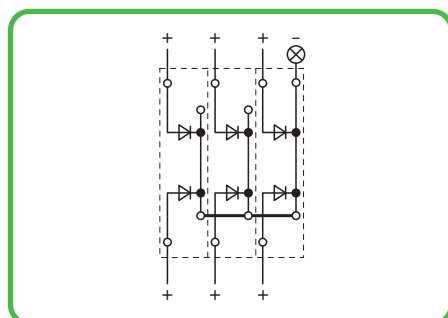

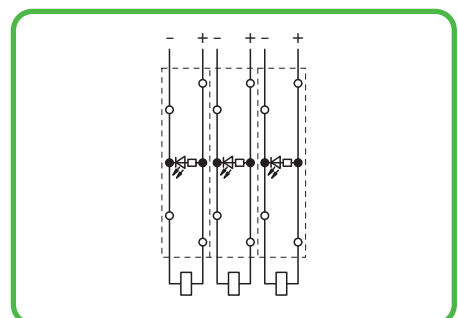

Used for collective fault indication



Used for voltage indication

Triple Deck Diode Terminal Blocks / Triple Deck LED Terminal Blocks
2.5 mm²/4 mm² / AWG 12, Series 2002

<p>0.25 – 2.5 (4) mm² ① AWG 22 – 12 U_N 250 V; U_{RM} 1000 V 1 N 4007 – 0.5 A continuous current</p> <p>Terminal block width 5.2 mm / 0.205 in  10 – 12 mm / 0.43 in</p>	<p>0.25 – 2.5 (4) mm² ① AWG 22 – 12 U_N 250 V; U_{RM} 1000 V 1 N 4007 – 0.5 A continuous current</p> <p>Terminal block width 5.2 mm / 0.205 in  10 – 12 mm / 0.43 in</p>
---	---

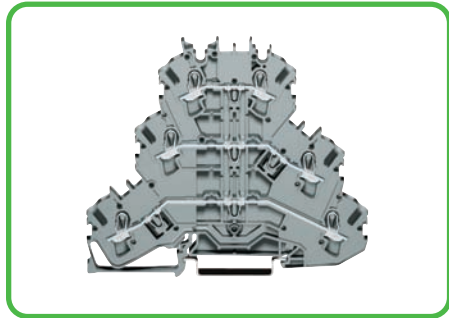

Through terminal blocks with the same shape see page 27



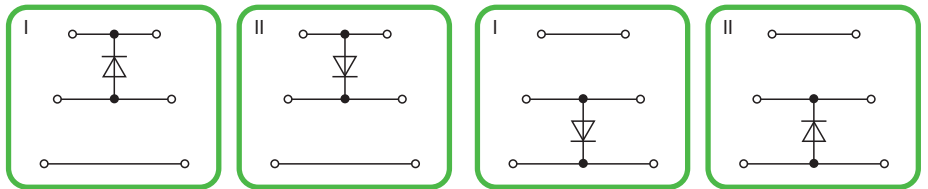
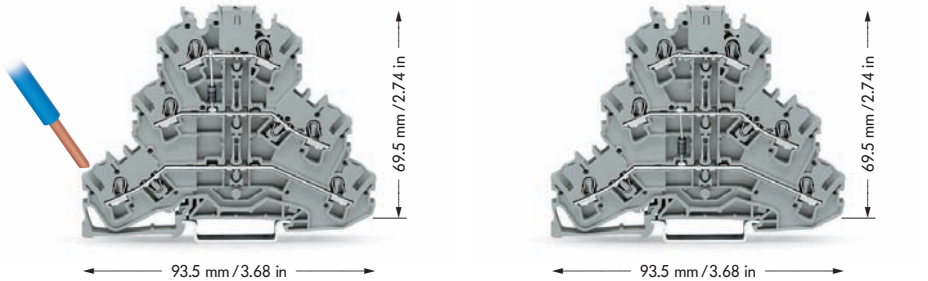

① can be connected: 0.25 mm² – 4 mm² "s + f-st";
 can be pushed in directly: 0.75 mm² – 4 mm² "s" and 0.75 mm² – 2.5 mm² "insulated ferrule, 12 mm"



Description	Item No.	Pack. unit pcs	Item No.	Pack. unit pcs
Triple deck diode terminal block	Triple deck diode terminal blocks with diode 1 N 4007		Triple deck diode terminal blocks with diode 1 N 4007	
and	Circuit I, grey	2002-3211/1000-0410 50	Circuit I, grey	2002-3211/1000-0675 50
Triple deck LED terminal block, for DIN 35 rail	Circuit II, grey	2002-3211/1000-0411 50	Circuit II, grey	2002-3211/1000-0676 50



Accessories

Appropriate marking system **WMB/WMB Inline** (see pages 38 to 39)

		0.8 mm / 0.031 in thick		0.8 mm / 0.031 in thick	
	End and intermediate plate	orange	2002-3292 100 (4 x 25)	orange	2002-3292 100 (4 x 25)
		grey	2002-3291 100 (4 x 25)	grey	2002-3291 100 (4 x 25)
	Push-in type jumper bars, light grey, insulated, I_N 25 A	2-way	2002-402 200 (8 x 25)	2-way	2002-402 200 (8 x 25)
		3-way	2002-403 200 (8 x 25)	3-way	2002-403 200 (8 x 25)
		4-way	2002-404 200 (8 x 25)	4-way	2002-404 200 (8 x 25)
		5-way	2002-405 100 (4 x 25)	5-way	2002-405 100 (4 x 25)
		:	:	:	:
		10-way	2002-410 100 (4 x 25)	10-way	2002-410 100 (4 x 25)
	Push-in type jumper bars, light grey, insulated, I_N 25 A	1 - 3	2002-433 200 (8 x 25)	1 - 3	2002-433 200 (8 x 25)
		1 - 4	2002-434 200 (8 x 25)	1 - 4	2002-434 200 (8 x 25)
		1 - 5	2002-435 100 (4 x 25)	1 - 5	2002-435 100 (4 x 25)
		:	:	:	:
		1 - 10	2002-440 100 (4 x 25)	1 - 10	2002-440 100 (4 x 25)
			Two-way marking adapter, pivotable		2002-131 50 (2 x 25)

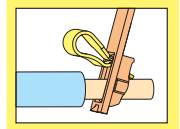
available
July 2006



<p>0.25 – 2.5 (4) mm² ① AWG 22 – 12 U_N 250 V; U_{RM} 1000 V I_N 4007 – 0.5 A continuous current</p> <p>Terminal block width 5.2 mm / 0.205 in  10 – 12 mm / 0.43 in</p>	<p>0.25 – 2.5 (4) mm² ① AWG 22 – 12 DC 24 V I_F 25 mA max.</p> <p>Terminal block width 5.2 mm / 0.205 in  10 – 12 mm / 0.43 in</p>
---	---

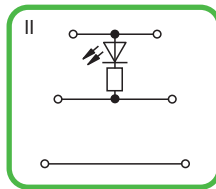
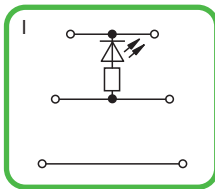
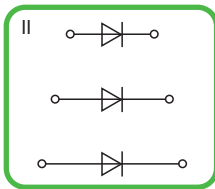
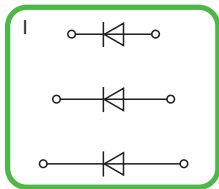
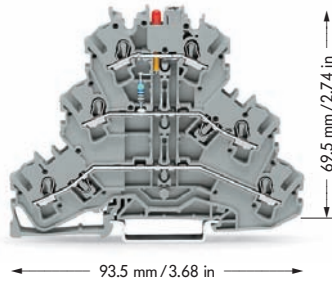
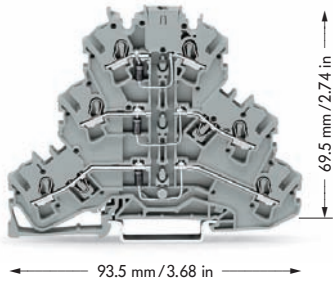

Item No.	Pack. unit pcs	Item No.	Pack. unit pcs
Triple deck diode terminal blocks with 3 diodes 1 N 4007		Triple deck LED terminal blocks with red LED, DC 24 V	
Circuit I, grey	2002-3212/1000-0673 50	Circuit I, grey	2002-3221/1000-0434 50
Circuit II, grey	2002-3212/1000-0674 50	Circuit II, grey	2002-3221/1000-0413 50

Appropriate marking system **WMB/WMB Inline** (see pages 38 to 39)

0.8 mm / 0.031 in thick			0.8 mm / 0.031 in thick		
orange	2002-3292	100 (4 x 25)	orange	2002-3292	100 (4 x 25)
grey	2002-3291	100 (4 x 25)	grey	2002-3291	100 (4 x 25)
2-way	2002-402	200 (8 x 25)	2-way	2002-402	200 (8 x 25)
3-way	2002-403	200 (8 x 25)	3-way	2002-403	200 (8 x 25)
4-way	2002-404	200 (8 x 25)	4-way	2002-404	200 (8 x 25)
5-way	2002-405	100 (4 x 25)	5-way	2002-405	100 (4 x 25)
:	:		:	:	
10-way	2002-410	100 (4 x 25)	10-way	2002-410	100 (4 x 25)
1 - 3	2002-433	200 (8 x 25)	1 - 3	2002-433	200 (8 x 25)
1 - 4	2002-434	200 (8 x 25)	1 - 4	2002-434	200 (8 x 25)
1 - 5	2002-435	100 (4 x 25)	1 - 5	2002-435	100 (4 x 25)
:	:		:	:	
1 - 10	2002-440	100 (4 x 25)	1 - 10	2002-440	100 (4 x 25)
	2002-131	50 (2 x 25)		2002-131	50 (2 x 25)

WAGO Multi Marking System WMB Horizontal Marking

	Horizontal marking Consecutive numbers each strip 10 strips with 10 markers per card for terminal block widths 4 – 4.2 mm und 5 – 12 mm	
--	--	--



Marking per card	Item No.	Item No.	Pack. unit pcs
	Marker width		
	4 – 4.2 mm	5 – 5.2 mm	
1 ... 10 (10x)	793-4502	793-5502	5 cards
11 ... 20 (10x)	793-4503	793-5503	5 cards
21 ... 30 (10x)	793-4504	793-5504	5 cards
31 ... 40 (10x)	793-4505	793-5505	5 cards
41 ... 50 (10x)	793-4506	793-5506	5 cards
51 ... 60 (10x)	793-4569	793-5569	5 cards
61 ... 70 (10x)	793-4570	793-5570	5 cards
71 ... 80 (10x)	793-4571	793-5571	5 cards
81 ... 90 (10x)	793-4572	793-5572	5 cards
91 ... 100 (10x)	793-4573	793-5573	5 cards
1 ... 50 (2x)	793-4566	793-5566	5 cards
51 ... 100 (2x)	793-4507	793-5507	5 cards
101 ... 150 (2x)	793-4508	793-5508	5 cards
151 ... 200 (2x)	793-4509	793-5509	5 cards
201 ... 300 (1x)	793-4510	793-5510	5 cards
301 ... 400 (1x)	793-4511	793-5511	5 cards
401 ... 500 (1x)	793-4512	793-5512	5 cards
501 ... 600 (1x)	793-4513	793-5513	5 cards
601 ... 700 (1x)	793-4514	793-5514	5 cards
701 ... 800 (1x)	793-4515	793-5515	5 cards
801 ... 900 (1x)	793-4516	793-5516	5 cards
901 ... 1000 (1x)	793-4517	793-5517	5 cards
1 ... 9, ; (10x)	793-4565	793-5565	5 cards
L1, L2, L3, N, PE, L1, L2, L3, N, PE (10x)	793-4472	793-5472	5 cards
R, S, T, U, V, W, X, Y, Z, Mp (10x)	793-4544	793-5544	5 cards
A, B, P, N, PE, PEN, L1, L2, L3, ⊕ (10x)	793-4545	793-5545	5 cards
for double deck terminal blocks	for double deck terminal blocks		
1, 3, 5, 7, 9, 11, ... 99 und 2, 4, 6, 8, 10, 12, ... 100 (1x)	–	793-5599	5 cards
for triple deck terminal blocks	for triple deck terminal blocks		
1, 4, 7, ... 99 (1x)	–	794-5557	5 cards
100, 103, 106, ... 198 (1x)	–	794-5558	5 cards
	WMB Inline	2009-115	
	(see page 40)		



Stretching of a strip, stretchable from 4 mm up to 4.2 mm for series 2001 stretchable from 5 mm up to 5.2 mm for series 2002



Separation of an individual marker from the strip, for series > 2002

WAGO Multi Marking System WMB Vertical Marking

Colored Marker Cards

	Vertical marking Consecutive numbers each strip 10 strips with 10 markers per card for terminal block widths 4 – 4.2 mm und 5 – 12 mm	
--	--	--

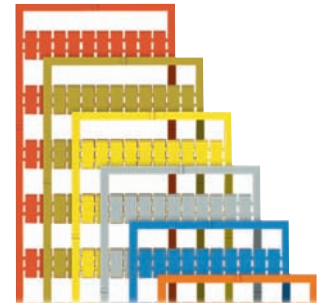
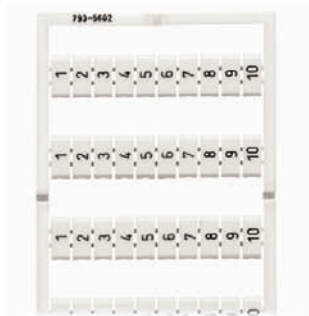

Marking per card	Item No.	Item No.	Pack. unit pcs	Color	Item No.
	Marker width			Colored marker cards	
	4 – 4.2 mm	5 – 5.2 mm		All the markings shown are also available with black printing on colored marker cards.	
1 ... 10 (10x)	793-4602	793-5602	5 cards		
11 ... 20 (10x)	793-4603	793-5603	5 cards	Add. item no. for colored marker cards	
21 ... 30 (10x)	793-4604	793-5604	5 cards	yellow	.../000-002
31 ... 40 (10x)	793-4605	793-5605	5 cards	red	.../000-005
41 ... 50 (10x)	793-4606	793-5606	5 cards	blue	.../000-006
51 ... 60 (10x)	794-4601	794-5601	5 cards	grey	.../000-007
61 ... 70 (10x)	794-4602	794-5602	5 cards	orange	.../000-012
71 ... 80 (10x)	794-4603	794-5603	5 cards	light green	.../000-017
81 ... 90 (10x)	794-4604	794-5604	5 cards	green	.../000-023
91 ... 100 (10x)	794-4605	794-5605	5 cards	violet	.../000-024
1 ... 50 (2x)	793-4666	793-5666	5 cards		
51 ... 100 (2x)	793-4607	793-5607	5 cards		Ordering examples
101 ... 150 (2x)	793-4608	793-5608	5 cards		Terminal block width 4 mm – WMB card
151 ... 200 (2x)	793-4609	793-5609	5 cards		Marking 1 ... 50 on blue card 793-4566/000-006
201 ... 300 (1x)	793-4610	793-5610	5 cards		
301 ... 400 (1x)	793-4611	793-5611	5 cards		
401 ... 500 (1x)	793-4612	793-5612	5 cards		Terminal block width 5 mm – WMB card
501 ... 600 (1x)	793-4613	793-5613	5 cards		Marking 1 ... 50 on green card 793-5566/000-023
601 ... 700 (1x)	793-4614	793-5614	5 cards		
701 ... 800 (1x)	793-4615	793-5615	5 cards		
801 ... 900 (1x)	793-4616	793-5616	5 cards		
901 ... 1000 (1x)	793-4617	793-5617	5 cards		Note:
1 ... 9, ;(10x)	793-4665	793-5665	5 cards		Please note that colored marker cards are normally on longer delivery and more expensive than standard cards.
101, 101, 101, 102, 102, 102, ... 130, 130, 130 (1x)	793-4667	793-5667	5 cards		
131, 131, 131, 132, 132, 132, ... 160, 160, 160 (1x)	793-4668	793-5668	5 cards		
L1, L2, L3, N, PE, L1, L2, L3, N, PE (10x)	794-4672	794-5672	5 cards	plain, for self-marking	
R, S, T, U, V, W, X, Y, Z, Mp (10x)	793-4644	793-5644	5 cards		793-4501 793-5501 5 cards
A, B, P, N, PE, PEN, L1, L2, L3, ⊕ (10x)	793-4645	793-5645	5 cards	Marking pen	210-110 1
for double deck terminal blocks	for double deck terminal blocks			with fibre tip,	
1, 3, 5, 7, 9, 11, ... 99 und 2, 4, 6, 8, 10, 12, ... 100 (1x)		793-5699	5 cards	for permanent marking	
101, 103, 105, ... 149 und 102, 104, 106, ... 150 (2x)		793-5900	5 cards		
for triple deck terminal blocks	for triple deck terminal blocks				
1, 4, 7, ... 99 (1x)		794-4657	5 cards		
100, 103, 106, ... 198 (1x)		794-5658	5 cards		
	WMB Inline	2009-115			
	(see page 40)				

Cost-Efficient and Fast Marking

WMB Inline	Marking strip, white for center marking	Thermal transfer printer
-------------------	--	---------------------------------



Item No.	Pack.-unit pcs	Item No.	Pack.-unit pcs	Item No.
WMB Inline , pitch 5 mm/0.197 in, stretchable 5 mm – 5.2 mm/0.197 in – 0.205 in, on roll, 1,500 markers white	2009-115	1		
		Marker strip , white, plain for center marking		
		11 mm/0.039 in wide, on roll		
		50 m	2009-110	1
		300 m	2009-130	1
				Thermal transfer printer, TP 298 258-298
				Resolution 300 dpi, without display
				ProServe Software included
				Marking systems:
				WMB markers on roll
				marker strips 50 m and 300 m on roll
				and
				labels

Application notes

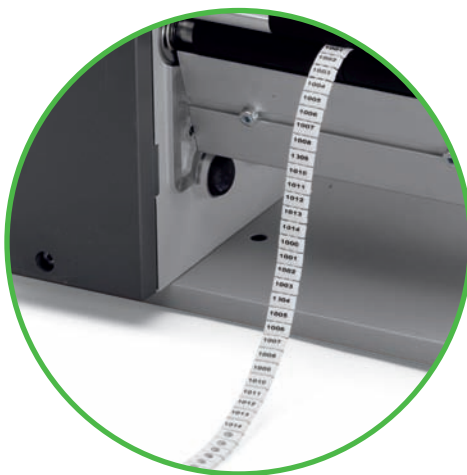

WMB Inline
WMB markers on roll

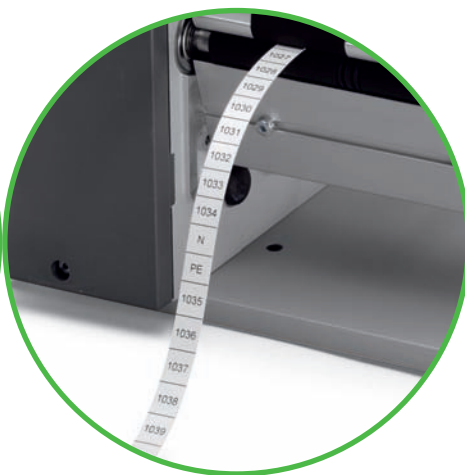

Marker strips
on roll



Labels

Mounting Accessories Carrier Rails and Stickers for Operating Instructions

TOPJOB®S group marker carriers Module width 5 mm / 0.197 in Module width 10 mm / 0.394 in Module width 15 mm / 0.591 in for marker cards and self-adhesive marker cards	Adjustable height group marker carriers End stop	Screwdrivers with partially insulated shaft for optimum handling in terminal blocks
--	--	--

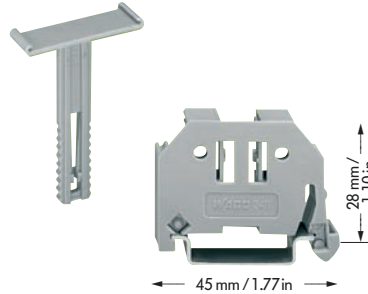

Item No.	Pack.-unit pcs	Item No.	Pack.-unit pcs	Item No.	Pack.-unit pcs
TOPJOB®S group marker carrier, snap-on type for jumper slot		Adjustable height group marker carriers, 249-119		Screwdriver with partially insulated shaft, type 1, blade 2.5 x 0.4 mm / 0.098 in x 0.016 in, suitable for series 2001	
5 mm / 0.197 in wide 2009-191	50	Marker card . . ., from white cardboard, for self-marking, 100 markers per sheet	50 (2 x 25)	210-619	1
10 mm / 0.394 in wide 2009-192	50	209-113	1 sheet	type 2, blade 3.5 x 0.5 mm / 0.137 in x 0.020 in, suitable for Series 2002, 2004	210-620
15 mm / 0.591 in wide 2009-193	50	. . . or self-adhesive label, for self-marking, 7 x 25 pcs per sheet	1 sheet	210-621	1
suitable for: WAGO Multi marking system WMB, miniature WSB Quick marking system, marker strips, 11 mm wide		Protection cover, transparent	50	Screwdrivers with partially insulated shaft, – set – types 1 – 3	210-622
for marker cards and self-adhesive marker cards		End stop, for DIN 35 rail			
2009-196	50	6 mm / 0.236 in wide 249-116	100 (4 x 25)		
		10 mm / 0.394 in wide 249-117	50 (2 x 25)		

Carrier rail 35 x 7.5 mm, 1 mm / 0.039 in thick, acc. to EN 60715, Steel, I_N 76 A (referred to a length of 1 m)	Operating sticker for TOPJOB®S rail-mounted terminal blocks Size 80 mm x 101 mm	Operating sticker for TOPJOB®S jumpers Size 80 mm x 101 mm
---	---	--

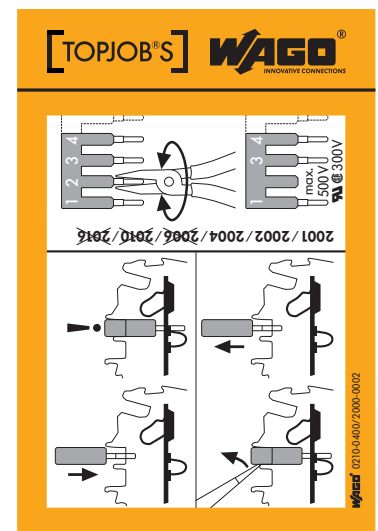
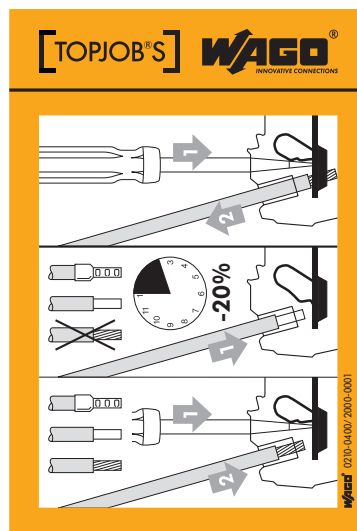
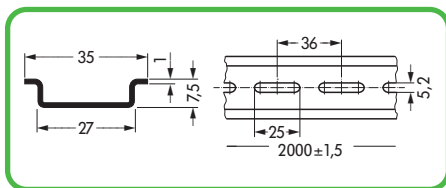

Item No.	Pack.-unit pcs	Item No.	Pack.-unit pcs	Item No.	Pack.-unit pcs
2 m / 6'6" long		Operating sticker, for TOPJOB®S rail-mounted terminal blocks		Operating sticker, for TOPJOB®S jumpers	
Steel rail 35 x 7.5 mm, 1 mm / 0.039 in thick unslotted	210-113	Series 2001/2002/2004/2006/2010/2016		Series 2001/2002/2004/2006/2010/2016	
Steel rail 35 x 7.5 mm, 1 mm / 0.039 in thick slotted	210-112	210-400/2000-0001	100	210-400/2000-0002	100

TOPJOB[®]S

Ferrules for Rail-Mounted Terminal Blocks and Crimping Tools

Insulated ferrules, electrolytic copper, electro-tin plated, acc. to DIN 46228, part 4/09.90		
--	--	--



Dimensions (in mm)	suitable for series	Sleeve for mm ²	AWG	Color	Stripped length mm	L	L1	D mm	D1	D2	Item No	Pack.-unit pcs
	2001 – 2002	0.5	22	white	12	16	10	3.1	2.6	1.0	216-241	1000
	2001 – 2002	0.75	20	grey	12	16	10	3.3	2.8	1.2	216-242	1000
	2002 – 2006	0.75	20	grey	14	18	12	3.3	2.8	1.2	216-262	1000
	2001 – 2002	1.0	18	red	12	16	10	3.5	3.0	1.4	216-243	1000
	2002 – 2006	1.0	18	red	14	18	12	3.5	3.0	1.4	216-263	1000
	2001 – 2002	1.5	16	black	12	16	10	4.0	3.5	1.7	216-244	1000
	2002 – 2006	1.5	16	black	14	18	12	4.0	3.5	1.7	216-264	1000
	2010 – 2016	1.5	16	black	20	24	18	4.0	3.5	1.7	216-284	1000
	2002	2.5	14	blue	12	17	10	4.7	4.2	2.2	216-246	1000
	2002 – 2006	2.5	14	blue	14	19	12	4.7	4.2	2.2	216-266	1000
	2010 – 2016	2.5	14	blue	20	25	18	4.7	4.2	2.2	216-286	1000
	2004 – 2006	4.0	12	grey	14	20	12	5.4	4.8	2.8	216-267	500
2010 – 2016	4.0	12	grey	20	26	18	5.4	4.8	2.8	216-287	500	
2006	6.0	10	yellow	14	20	12	6.9	6.3	3.5	216-208	500	
2010 – 2016	6.0	10	yellow	20	26	18	6.9	6.3	3.5	216-288	500	
2010 – 2016	10.0	8	red	20	28	18	8.4	7.6	4.5	216-289	500	
2016	16.0	6	blue	23	28	18	9.6	8.8	5.8	216-210	500	











Application notes













- With the Variocrimp 4 built-in crimping pressure plates control the crimping force automatically for the conductor cross section used. With the Variocrimp 16 it is necessary to select the wire gauge on the tool before crimping.
- Each tool has only one crimping station for all the wire sizes handled.
- Uniform compact crimping from all four sides for high conductor retention.
- No need to center the conductor in the ferrule sleeve.
- Conductor and ferrule insertion possible from both sides (for left- and right handed).
- Built-in ratchet to guarantee complete crimping every time.
- Tools open automatically after crimping operation is complete.
- Comfortable handles for operator.

Item No.	Pack. unit pcs	Item No.	Pack. unit pcs
Variocrimp 4, Crimping tool for ferrules		Variocrimp 16, Crimping tool for ferrules	
insulated and uninsulated, 0.25 mm ² – 4 mm ² / AWG 24 – 12		insulated and uninsulated, 6 mm ² – 16 mm ² / AWG 10 – 6	
206-204	1	206-216	1
weight 400 g / 0.882 lbs		weight 580 g / 1.28 lbs	

TOPJOB[®]S Overview of Connectable Ferrules from 0.5 mm²

											
Series	Rated cross-section in mm ²	0.5 mm ²	0.75 mm ²	1 mm ²	1.5 mm ²	2.5 mm ²	4 mm ²	6 mm ²	10 mm ²	16 mm ²	
2001	0.25 – 1.5 (2.5)	216-241	216-242	216-243	216-244	—	—	—	—	—	
2002	0.25 – 2.5 (4)	216-241	216-242	216-243	216-244	216-246	—	—	—	—	
2003	0.25 – 2.5 (4)	216-241	216-242	216-243	216-244	216-246	—	—	—	—	
2004	0.5 – 4 (6)	—	216-262	216-263	216-264	216-266	216-267	—	—	—	
2005	0.5 – 4 (6)	—	216-262	216-263	216-264	216-266	216-267	—	—	—	
2006	0.5 – 6 (10)	—	216-262	216-263	216-264	216-266	216-267	216-208	—	—	
2010	0.5 – 10 (16)	—	—	216-263	216-284	216-286	216-287	216-288	216-289	—	
2016	0.5 – 16 (25)	—	—	—	216-284	216-286	216-287	216-288	216-289	216-210	

TOPJOB[®]S Overview of Ferrules that can be Connected Directly (Push In)

											
Series	Rated cross-section in mm ²	0.5 mm ²	0.75 mm ²	1 mm ²	1.5 mm ²	2.5 mm ²	4 mm ²	6 mm ²	10 mm ²	16 mm ²	
2001	0.25 – 1.5 (2.5)	—	216-242	216-243	216-244	—	—	—	—	—	
2002	0.25 – 2.5 (4)	—	216-242	216-243	216-244	216-246	—	—	—	—	
2003	0.25 – 2.5 (4)	—	216-242	216-243	216-244	216-246	—	—	—	—	
2004	0.5 – 4 (6)	—	216-262	216-263	216-264	216-266	216-267	—	—	—	
2005	0.5 – 4 (6)	—	216-262	216-263	216-264	216-266	216-267	—	—	—	
2006	0.5 – 6 (10)	—	—	—	216-264	216-266	216-267	216-208	—	—	
2010	0.5 – 10 (16)	—	—	—	—	216-286	216-287	216-288	216-289	—	
2016	0.5 – 16 (25)	—	—	—	—	216-286	216-287	216-288	216-289	216-210	

Examples of Circuit Configuration for WAGO TOPJOB® S

Distribution using multilevel installation terminal block (Series 2003), for three-phase and single phase a.c. with 2 residual current circuit breakers

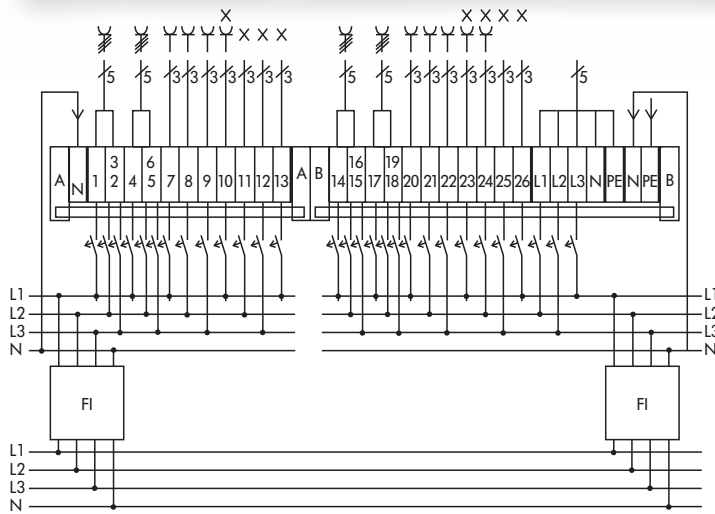
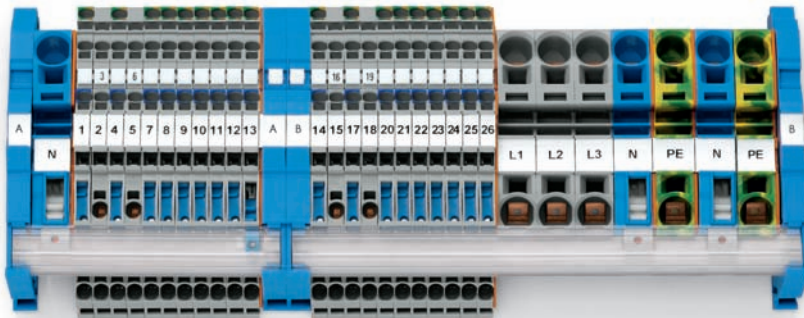

Parts list

- 18 x 2003-7641 NT/L/PE
- 4 x 2003-7642 L/L
- 2 x 2003-7692 End plate
- 3 x 2016-1201 L
- 2 x 2016-1207 PE
- 3 x 2016-7114 NT
- 2 x 2016-7192 End plate
- 2 x 2016-1292 End plate
- 4 x 2009-305 Busbar carrier with end stop function
- 1 x 210-133 N-busbar
- 1 x 777-303 Transparent cover
- 1 x 2009-110 Marker strips
- 1 x 248-501 Mini-WSB
- 1 x 248-502 Mini-WSB

Supply of the TN-S system (mains) using the Series 2002, 2003, 2006 and 2016

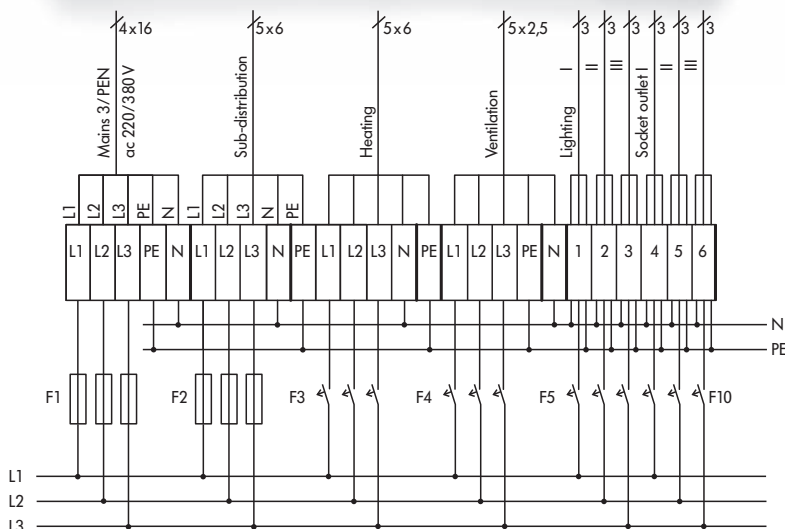
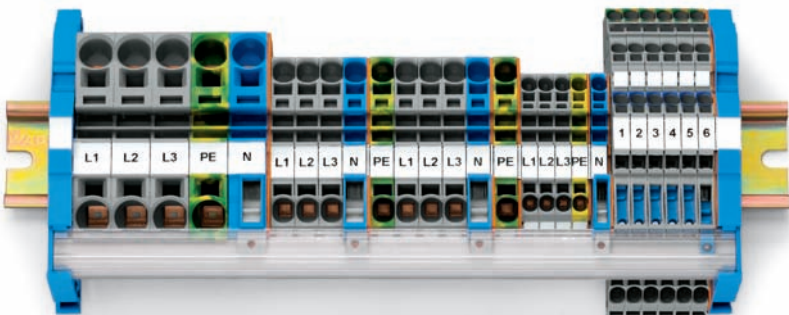

Parts list

- 6 x 2003-7641 NT/L/PE
- 1 x 2003-7692 End plate
- 3 x 2002-1201 L
- 1 x 2002-1207 PE
- 1 x 2002-7114 NT
- 1 x 2002-1292 End plate
- 1 x 2002-7192 End plate
- 6 x 2006-1201 L
- 2 x 2006-1207 PE
- 1 x 2006-1292 End plate
- 2 x 2006-7114 NT
- 2 x 2006-7192 End plate
- 3 x 2016-1201 L
- 1 x 2016-1207 PE
- 1 x 2016-7114 NT
- 1 x 2016-7192 End plate
- 2 x 2009-305 Busbar carrier with end stop function
- 1 x 210-133 N-busbar
- 1 x 777-303 Transparent cover
- 1 x 2009-110 Marker strips

Distribution for office floor / wiring of the lighting to the distribution

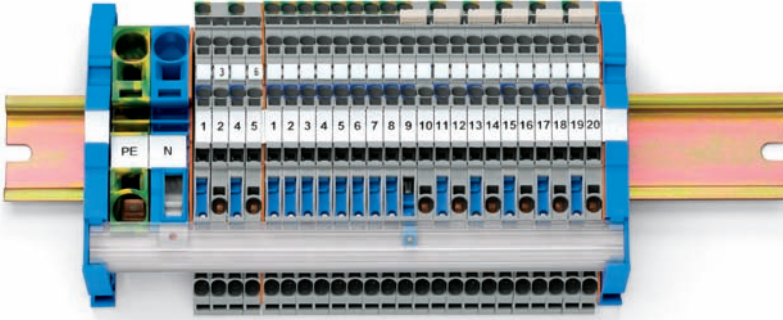

Parts list

- 1 x 2016-1207 PE
- 1 x 2016-7114 NT
- 1 x 2016-7192 End plate
- 16 x 2003-7641 NT/L/PE
- 8 x 2003-7642 L/L
- 2 x 2003-7692 End plate
- 2 x 2009-305 Busbar carrier with end stop function
- 1 x 210-133 N-busbar
- 1 x 777-303 Transparent cover
- 6 x 2002-402 Push-in type jumper bar
- 1 x 2009-110 Marker strips
- 1 x 248-566 Mini-WSB

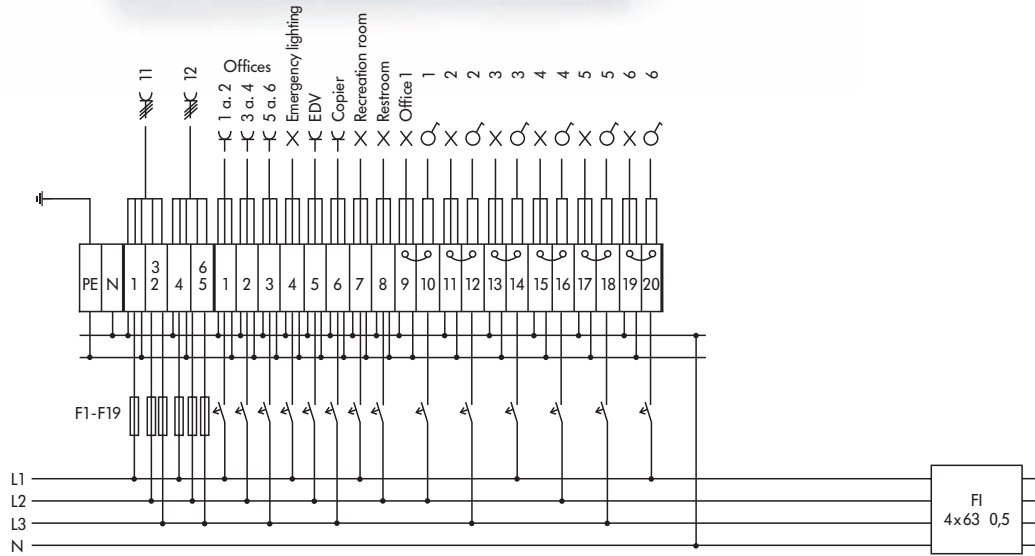

Application Examples for TOPJOB[®]S Multilevel Installation

Standard consumer unit

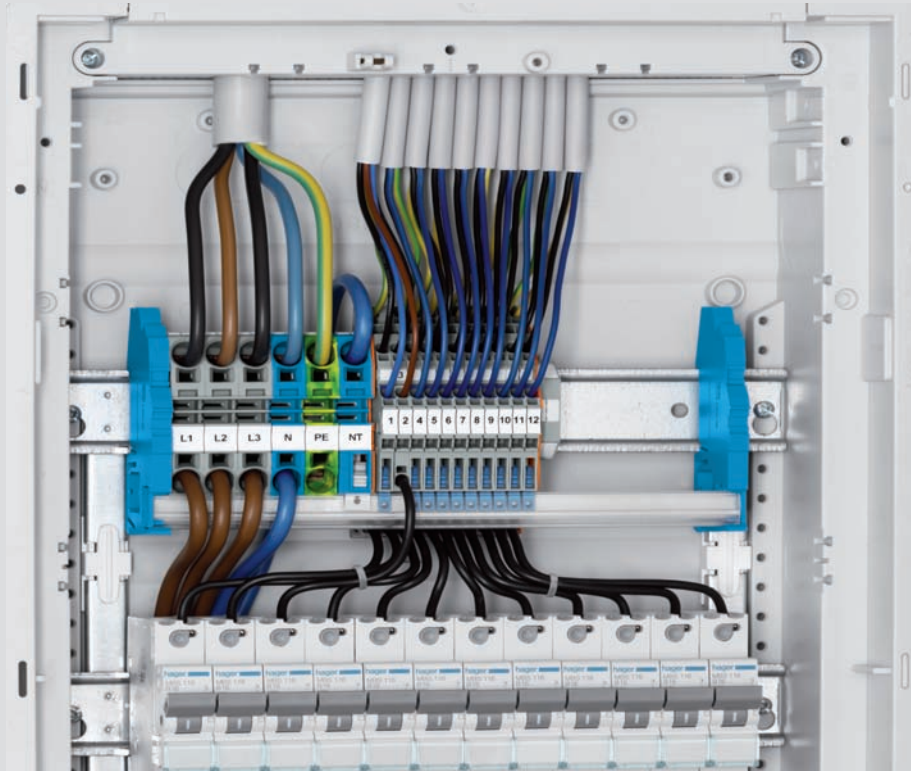

Standard assembly of the multilevel installation terminal blocks on the carrier rail which is closest to the conductor entries.

Advantages:

- Short wire lengths in the distribution box
- Clear arrangement of the circuits
- Large wiring space through small terminal block dimensions

On-wall mounted distribution box with double power line wiring using multilevel installation terminal blocks

The small dimensions of the multilevel installation terminal blocks make it possible to conveniently wire two carrier rails, one below the other.

Advantages:

- Spatial separation of the circuits that are assigned to the individual residual current circuit breakers
- All groups of terminals can easily be extended

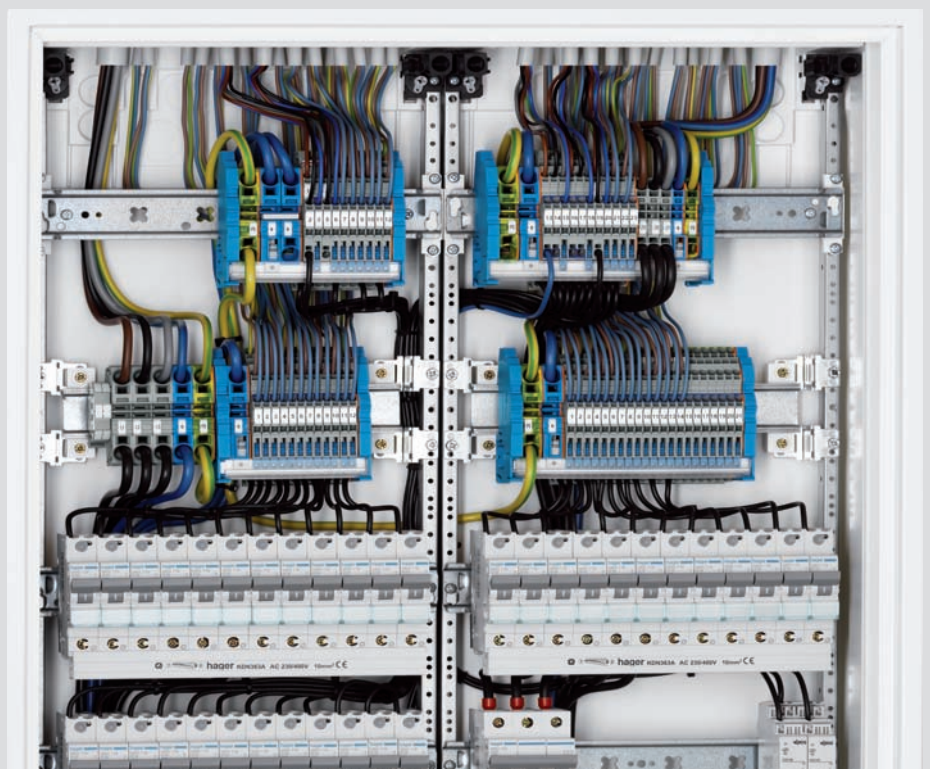

Terminal Blocks in Standard Distribution Boxes

On-wall mounted distribution box for power lines and building automation components

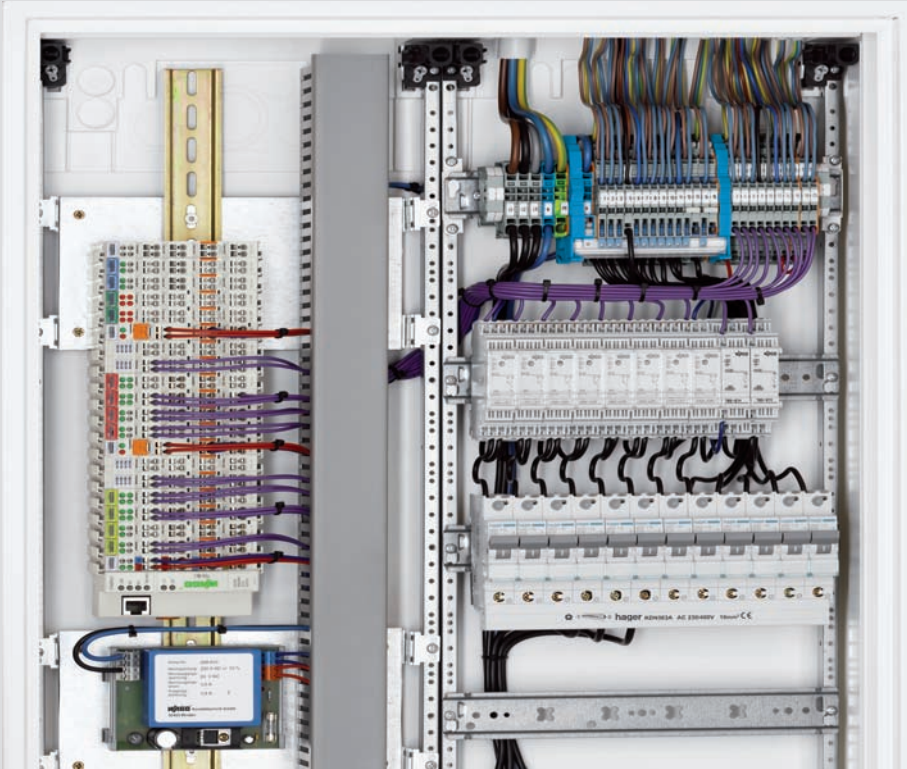

Separate arrangement of automation components and installation devices.

Advantages:

- Visual separation of power devices and electronics allows easy assignment of functions and error checking
- Optimal utilization of the bus controllers through a long, vertically mounted carrier rail

TOPJOB[®]S

Examples of Circuit Configuration with Staggered Jumpers

Commoning sockets/lighting fixtures

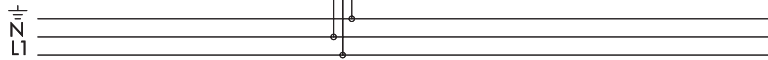
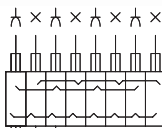
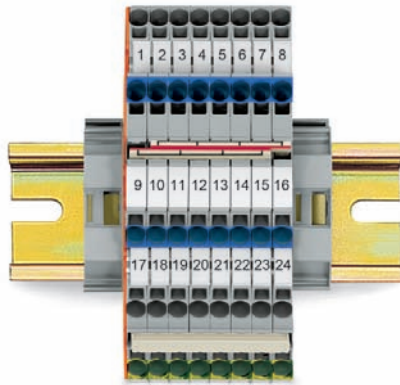

Parts list

- 2 x 249-117 End stop 10 mm
- 8 x 2003-7646 Multilevel installation terminal block N/L/PE
- 2 x 2002-477 Staggered jumper 7-way
- 1 x 2002-408 Push-in type jumper bar 8-way
- 1 x 2009-110 Marker strips
- 1 x 793-5566 WMB

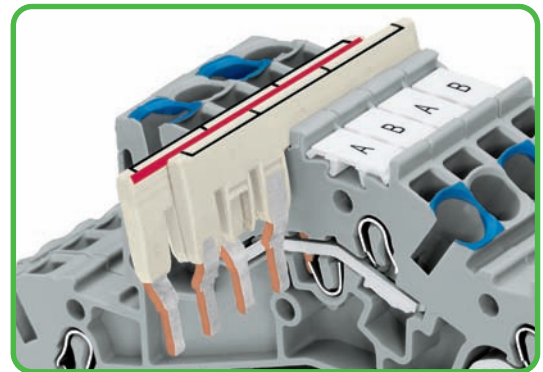

Commoning three-phase circuits

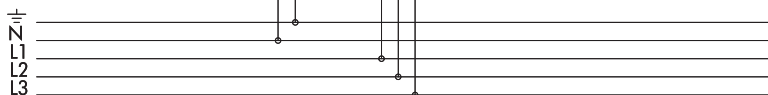
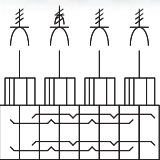
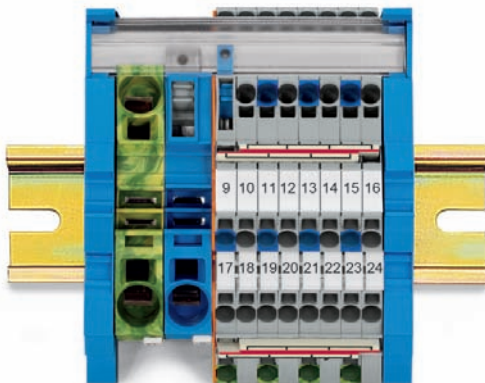

Parts list



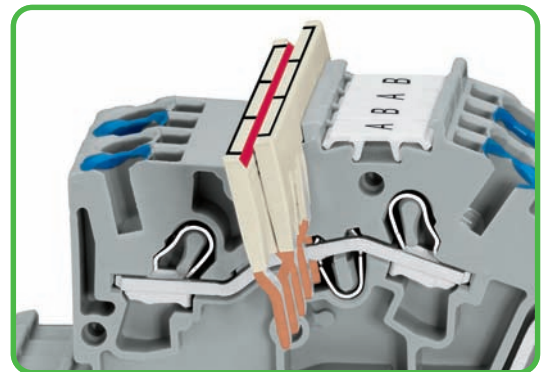





- 2 x 2009-305 Busbar carrier with end stop function
- 1 x 2016-1207 2-conductor earth conductor terminal block
- 1 x 2016-7114 Single conductor N-disconnect terminal block
- 1 x 2003-7641 Multilevel installation terminal block NT/L/PE
- 4 x 2003-7642 Multilevel installation terminal block L/L
- 3 x 2003-7646 Multilevel installation terminal block N/L/PE
- 4 x 2002-477 Staggered jumper 7-way
- 1 x 2009-110 Marker strips
- 1 x 793-5566 WMB



Approvals

Dated April 2006

A list of approvals (update: catalog deadline) is provided on this page. Due to the numerous agencies and approvals as well as the ever-increasing number of new products, our online catalog provides you with complete up-to-date information at www.wago.com

Item No.	Approval-No.	Vol-tage V	Cur-rent A	Cross Section AWG/mm²	Item No.	Approval-No.	Vol-tage V	Cur-rent A	Cross Section AWG/mm²	Item No.	Approval-No.	Vol-tage V	Cur-rent A	Cross Section AWG/mm²	Item No.	Approval-No.	Vol-tage V	Cur-rent A	Cross Section AWG/mm²										
 UL – Underwriters Laboratories USA					 LR – Lloyd's Register of Shipping Great Britain					 CENELEC CERTIFICATION AGREEMENT CCA-NL – N.V. tot Keuring van Elektrotechnische Materialen, Netherlands					 URUS – Underwriters Laboratories USA														
2001-120	E45172	600	15	22-14	2010-1207	154112-1645436	600	65	20-6	2004-120	IECEX				2001-120	E185892	550	15	22-14										
2001-1207	E45172			22-14	2010-130	154112-1645436			20-6	2004-1207	PTB05.0033U	550	30	0,5-6	2001-1207	E185892			22-14										
2001-130	E45172	600	15	22-14	2010-1307	154112-1645436	600	85	20-4	2004-1207	IECEX/PTB05.0033U	550	30	0,5-6	2001-130	E185892	550	15	22-14										
2001-1307	E45172			22-14	2016-120	154112-1579112	600	85	20-4	2004-130	PTB05Atex1095U	550	30	0,5-6	2001-140	E185892	550	15	22-14										
2001-140	E45172	600	15	22-14	2016-1207	154112-1579112	600	85	20-4	2004-1307	IECEX/PTB05.0033U	550	30	0,5-6	2001-1407	E185892	550	15	22-14										
2001-1407	E45172			22-14	2016-130	154112-1579112	600	85	20-4	2004-140	PTB05Atex1095U	550	30	0,5-6	2001-1407	E185892	550	15	22-14										
2002-120	E45172	600	20	22-12	2016-1307	154112-1579112	600	85	20-4	2004-1407	IECEX/PTB05.0033U	550	30	0,5-6	2002-120	E185892	550	20	22-12										
2002-1207	E45172			22-12	 GL – Germanischer Lloyd Germany					2004-130	PTB05Atex1095U	550	30	0,5-6	2002-1207	E45172	600	20	22-12										
2002-130	E45172	600	20	22-12						2002-120	91/20112(E3)	800	24	0,5-4	2004-1307	IECEX				2002-130	E45172	600	20	22-12					
2002-1307	E45172			22-12						2002-1207	91/20112(E3)			0,5-4	2004-140	PTB05.0033U	550	30	0,5-6	2002-1307	E45172	600	20	22-12					
2002-140	E45172	600	20	22-12						2002-130	91/20112(E3)	800	24	0,5-4	2004-1407	IECEX/PTB05.0033U	550	30	0,5-6	2002-140	E45172	600	20	22-12					
2002-1407	E45172			22-12						2002-1307	91/20112(E3)			0,5-4	2004-1407	PTB05.0033U	550	30	0,5-6	2002-1407	E45172	600	20	22-12					
2002-1407	E45172	600	20	22-12						2002-140	91/20112(E3)	800	24	0,5-4	2004-1407	IECEX				2002-1407	E45172	600	20	22-12					
2002-22	E45172	300/600	20/5	22-12						2002-1407	91/20112(E3)			0,5-4	2004-1407	PTB05.0033U	550	30	0,5-6	2002-22	E45172	300/600	20/5	22-12					
2002-32	E45172	300/600	20/5	22-12						2006-120	91/20112(E3)	800	41	0,5-10	2006-120	PTB05Atex1030U	550	33	0,5-10	2002-32	E45172	300/600	20/5	22-12					
2004-120	E45172	600	30	20-10						2006-1207	91/20112(E3)			0,5-10	2006-1207	IECEX				2004-120	E45172	600	30	20-10					
2004-1207	E45172			20-10						2006-130	91/20112(E3)	800	41	0,5-10	2006-130	PTB05Atex1030U	550	33	0,5-10	2004-1207	E45172			20-10					
2004-130	E45172	600	30	20-10						2006-1307	91/20112(E3)			0,5-10	2006-1307	IECEX				2004-140	E45172	600	30	20-10					
2004-1307	E45172			20-10						2016-120	91/20112(E3)	800	76	0,5-25 *F	2016-120	PTB05.0014U	550	33	0,5-10	2004-1407	E45172	600	30	20-10					
2004-140	E45172	600	30	20-10						2016-1207	91/20112(E3)			0,5-25 *F	2016-1207	IECEX				2006-120	E45172	600	50	20-8					
2004-1407	E45172			20-10						2016-130	91/20112(E3)	800	76	0,5-25 *F	2016-1307	PTB05Atex1030U	550	33	0,5-10	2006-1207	E45172	600	50	20-8					
2006-120	E45172	600	50	20-8						2016-1307	91/20112(E3)			0,5-25 *F	2016-1307	IECEX				2006-130	E45172	600	50	20-8					
2006-1207	E45172			20-8						 DNV – Det Norske Veritas Denmark					2006-1307	PTB05Atex1030U	550	33	0,5-10	2006-120	E45172	600	85	20-4					
2006-130	E45172	600	85	20-4	2002-120	91/20112(E3)	800	24	0,5-4						2006-130	PTB05.0014U	550	33	0,5-10	2006-1207	E45172	600	85	20-4					
2006-1207	E45172			20-4	2002-1207	91/20112(E3)			0,5-4						2006-1307	IECEX				2006-130	E45172	600	85	20-4					
2016-120	E45172	600	85	20-4	2002-130	91/20112(E3)	800	24	0,5-4						2006-1407	PTB05Atex1030U	550	33	0,5-10	2016-120	E45172	600	85	20-4					
2016-1207	E45172			20-4	2002-1307	91/20112(E3)			0,5-4						2006-1407	IECEX				2016-1207	E45172	600	85	20-4					
2016-130	E45172	600	85	20-4	2002-140	91/20112(E3)	800	24	0,5-4						2006-1407	PTB05Atex1030U	550	33	0,5-10	2016-130	E45172	600	85	20-4					
2016-1307	E45172			20-4	2002-1407	91/20112(E3)			0,5-4						2006-1407	IECEX				2016-1307	E45172	600	85	20-4					
 N.V. tot Keuring van Elektrotechnische Materialen, Netherlands					2002-120	91/20112(E3)	800	24	0,5-4						2006-120	PTB05Atex1030U	550	33	0,5-10	2016-140	E45172	600	85	20-4					
					2002-1207	91/20112(E3)			0,5-4						2006-1207	91/20112(E3)			0,5-10	2016-1407	PTB05.0003U	550	51	0,5-16	2016-1407	E45172	600	85	20-4
					2002-130	91/20112(E3)	800	24	0,5-4						2006-130	91/20112(E3)	800	41	0,5-10	2016-1407	IECEX				2016-140	E45172	600	85	20-4
					2002-1307	91/20112(E3)			0,5-4						2006-1307	91/20112(E3)			0,5-10	2016-1407	PTB05Atex1070U	550	51	0,5-16	2016-1407	E45172	600	85	20-4
					2002-140	91/20112(E3)	800	24	0,5-4						2006-140	91/20112(E3)	800	41	0,5-10	2016-1407	IECEX				2016-140	E45172	600	85	20-4
					2002-1407	91/20112(E3)			0,5-4						2006-1407	91/20112(E3)			0,5-10	2016-1407	PTB05Atex1070U	550	50	0,5-16	2016-1407	E45172	600	85	20-4
					2006-120	91/20112(E3)	800	41	0,5-10						2006-120	91/20112(E3)	800	41	0,5-10	2016-1407	IECEX				2016-140	E45172	600	85	20-4
					2006-1207	91/20112(E3)			0,5-10						2006-1207	91/20112(E3)			0,5-10	2016-1407	PTB05Atex1070U	550	50	0,5-16	2016-140	E45172	600	85	20-4
					2006-130	91/20112(E3)	800	41	0,5-10						2006-130	91/20112(E3)	800	41	0,5-10	2016-1407	IECEX				2016-140	E45172	600	85	20-4
					2006-1307	91/20112(E3)			0,5-10	2006-1307	91/20112(E3)			0,5-10	2016-1407	PTB05Atex1070U	550	50	0,5-16	2016-140	E45172	600	85	20-4					
					2016-120	91/20112(E3)	800	76	0,5-25 *F	2006-140	91/20112(E3)	800	76	0,5-25 *F	2016-1407	IECEX				2016-140	E45172	600	85	20-4					
					2016-1207	91/20112(E3)			0,5-25 *F	2016-120	91/20112(E3)	800	76	0,5-25 *F	2016-1407	PTB05Atex1070U	550	51	0,5-16	2016-140	E45172	600	85	20-4					
					2016-130	91/20112(E3)	800	76	0,5-25 *F	2016-1207	91/20112(E3)			0,5-25 *F	2016-1407	IECEX				2016-140	E45172	600	85	20-4					
					2016-1307	91/20112(E3)			0,5-25 *F	2016-130	91/20112(E3)	800	76	0,5-25 *F	2016-1407	PTB05Atex1070U	550	51	0,5-16	2016-140	E45172	600	85	20-4					
					 CSA – Canadian Standard Association Canada					2002-120	91/20112(E3)	800	24	0,5-4	 PTB Physikalische Technische Bundesanstalt Germany EEx e II					2010-120	PTB05Atex1070U	550	51	0,5-16					
										2002-1207	91/20112(E3)			0,5-4						2010-1207	PTB05Atex1070U	550	51	0,5-16	2010-1207	PTB05Atex1030U	550	51	0,5-16
2002-130	91/20112(E3)	800	24	0,5-4						2010-130	PTB05Atex1030U	550	51	0,5-16						2010-130	PTB05Atex1070U	550	51	0,5-16					
2002-1307	91/20112(E3)			0,5-4						2010-1307	PTB05Atex1070U	550	51	0,5-16						2010-1307	IECEX								
2002-140	91/20112(E3)	800	24	0,5-4						2010-140	PTB05.0003U	550	51	0,5-16						2010-140	PTB05Atex1070U	550	51	0,5-16					
2002-1407	91/20112(E3)			0,5-4						2010-1407	IECEX			0,5-16						2010-1407	PTB05Atex1070U	550	51	0,5-16					
2006-120	91/20112(E3)	800	41	0,5-10						2010-120	PTB05Atex1030U	550	51	0,5-16						2010-120	IECEX								
2006-1207	91/20112(E3)			0,5-10						2010-1207	PTB05Atex1070U	550	51	0,5-16						2010-1207	PTB05Atex1030U	550	51	0,5-16					
2006-130	91/20112(E3)	800	41	0,5-10						2010-130	PTB05Atex1070U	550	51	0,5-16						2010-130	IECEX								
2006-1307	91/20112(E3)			0,5-10						2010-1307	IECEX			0,5-16						2010-1307	PTB05Atex1030U	550	51	0,5-16					
2016-120	91/20112(E3)	800	76	0,5-25 *F						2010-140	PTB05.0003U	550	51	0,5-16						2010-140	PTB05Atex1070U	550	51	0,5-16					
2016-1207	91/20112(E3)			0,5-25 *F						2010-1407	IECEX			0,5-16						2010-1407	PTB05Atex1070U	550	51	0,5-16					
2016-130	91/20112(E3)	800	76	0,5-25 *F						2010-120																			

Index of Item Nos.

Item No.	Page	Item No.	Page	Item No.	Page	Item No.	Page	Item No.	Page
Series 206		Series 777		793-5606	39	2001-1402	16	2002-410	32
206-204	42	777-303	28	793-5607	39	2001-1404	16	2002-410	33
206-216	42			793-5608	39	2001-1407	16	2002-410	34
		Series 793		793-5609	39			2002-410	34
Series 209		793-1604	39	793-5610	39	Series 2002		2002-410	35
209-105	28			793-5611	39	2002-115	17	2002-410	36
209-113	41	793-4...	24	793-5612	39	2002-115	22	2002-410	37
209-114	41	793-4...	25	793-5613	39	2002-115	27	2002-433	17
		793-4...	25	793-5614	39	2002-115	31	2002-433	22
Series 210		793-4472	38	793-5615	39	2002-115	33	2002-433	26
210-110	39	793-4501	39	793-5616	39	2002-121	26	2002-433	27
210-112	41	793-4502	38	793-5617	39	2002-121	26	2002-433	28
210-113	41	793-4503	38	793-5644	39	2002-121	31	2002-433	31
210-133	28	793-4504	38	793-5645	39	2002-121	32	2002-433	32
210-136	24	793-4505	38	793-5665	39	2002-121	34	2002-433	33
210-136	25	793-4506	38	793-5666	39	2002-121	35	2002-433	34
210-136	28	793-4507	38	793-5667	39	2002-131	27	2002-433	34
210-136	31	793-4508	38	793-5668	39	2002-131	36	2002-433	35
210-136	32	793-4509	38	793-5699	39	2002-131	37	2002-433	36
210-136	33	793-4510	38	793-5900	39	2002-171	17	2002-433	37
210-137	24	793-4511	38			2002-171	22	2002-434	17
210-137	25	793-4512	38	Series 794		2002-171	31	2002-434	22
		793-4513	38	794-4...	24	2002-171	32	2002-434	27
210-281	28	793-4514	38	794-4601	39	2002-171	33	2002-434	28
		793-4515	38	794-4602	39	2002-172	17	2002-434	31
210-345	41	793-4516	38	794-4603	39	2002-172	22	2002-434	32
		793-4517	38	794-4604	39	2002-172	31	2002-434	33
210-619	41	793-4544	38	794-4605	39	2002-172	32	2002-434	34
210-620	41	793-4545	38	794-4606	39	2002-172	33	2002-434	35
210-621	41	793-4565	38	794-4657	39	2002-172	33	2002-434	36
210-622	41	793-4566/000-06	39	794-4672	39	2002-402	17	2002-434	37
		793-4602	39			2002-402	22	2002-435	17
210-400/2000-0001	41	793-4603	39	794-5...	24	2002-402	26	2002-435	22
210-400/2000-0002	41	793-4605	39	794-5...	25	2002-402	27	2002-435	26
		793-4606	39	794-5557	38	2002-402	28	2002-435	27
		793-4607	39	794-5558	38	2002-402	31	2002-435	28
		793-4608	39	794-5601	39	2002-402	32	2002-435	31
		793-4609	39	794-5602	39	2002-402	33	2002-435	32
Series 216		793-4610	39	794-5603	39	2002-402	34	2002-435	33
216-100	42	793-4611	39	794-5604	39	2002-402	35	2002-435	34
		793-4612	39	794-5605	39	2002-402	36	2002-435	35
216-208	42	793-4613	39	794-5658	39	2002-402	37	2002-435	36
216-241	42	793-4614	39	794-5672	39	2002-403	17	2002-435	37
216-242	42	793-4615	39			2002-403	22	2002-440	17
216-243	42	793-4616	39	Series 2001		2002-403	26	2002-440	22
216-244	42	793-4617	39	2001-171	16	2002-403	27	2002-440	26
216-246	42	793-4644	39			2002-403	28	2002-440	27
216-262	42	793-4645	39	2001-402	16	2002-403	31	2002-440	28
216-263	42	793-4665	39	2001-403	16	2002-403	32	2002-440	31
216-264	42	793-4666	39	2001-404	16	2002-403	33	2002-440	32
216-266	42	793-4667	39	2001-405	16	2002-403	34	2002-440	33
216-267	42	793-4668	39	2001-405	34	2002-403	35	2002-440	34
216-284	42			2001-410	16	2002-403	36	2002-440	35
216-286	42			2001-433	16	2002-404	37	2002-440	36
216-287	42	793-5...	24	2001-434	16	2002-404	17	2002-440	37
216-288	42	793-5...	25	2001-435	16	2002-404	22	2002-472	28
216-289	42	793-5472	38	2001-440	16	2002-404	26	2002-472	31
		793-5501	39			2002-404	27	2002-472	32
Series 248		793-5502	38	2001-511	16	2002-404	28	2002-472	33
248-...	25	793-5503	38	2001-511	24	2002-404	31	2002-473	28
		793-5504	38	2001-549	16	2002-404	32	2002-473	31
		793-5505	38	2001-549	24	2002-404	33	2002-473	32
Series 249		793-5506	38	2001-552	25	2002-404	34	2002-473	33
249-...	25	793-5507	38	2001-553	25	2002-404	35	2002-474	28
		793-5508	38	2001-554	25	2002-404	36	2002-474	31
249-116	41	793-5509	38	2001-555	25	2002-405	37	2002-474	32
249-117	41	793-5510	38	2001-556	25	2002-405	17	2002-474	33
		793-5511	38	2001-557	25	2002-405	22	2002-475	28
		793-5512	38	2001-558	25	2002-405	26	2002-475	31
		793-5513	38	2001-559	25	2002-405	27	2002-475	32
Series 258		793-5514	38	2001-560	25	2002-405	28	2002-475	33
258-298	40	793-5515	38			2002-405	31	2002-482	28
		793-5516	38	2001-1201	16	2002-405	32	2002-482	31
		793-5517	38	2001-1201	18	2002-405	33	2002-482	32
Series 734		793-5544	38	2001-1202	16	2002-405	34	2002-482	33
734-326	24	793-5545	38	2001-1202	16	2002-405	35		
734-326	25	793-5565	38	2001-1204	16	2002-405	36	2002-511	17
734-327	24	793-5566/000-23	39	2001-1207	16	2002-405	37	2002-511	22
734-327	25	793-5599	38	2001-1301	16	2002-410	17	2002-511	24
734-328	24	793-5602	39	2001-1302	16	2002-410	26	2002-511	31
734-328	25	793-5603	39	2001-1304	16	2002-410	27	2002-511	32
734-329	24	793-5604	39	2001-1307	16	2002-410	28	2002-511	33
734-329	25	793-5605	39	2001-1401	16	2002-410	31	2002-541	24

Item No.	Page	Item No.	Page	Item No.	Page	Item No.	Page	Item No.	Page
2002-549	17	2002-2292	34	2004-405	18	2009-110	24	2016-402	21
2002-549	22	2002-2292	35	2004-410	18	2009-110	25	2016-403	21
2002-549	31	2002-2951	33	2004-433	18	2009-110	26	2016-404	21
2002-549	32	2002-2952	33	2004-434	18	2009-110	27	2016-405	21
2002-552	25	2002-2954	33	2004-435	18	2009-110	40	2016-433	21
2002-553	25	2002-2958	33	2004-440	18	2009-115	25	2016-434	21
2002-554	25	2002-2959	33			2009-115	38	2016-435	21
2002-555	25	2002-2971	33	2004-511	18	2009-115	39	2016-499	20
2002-556	25	2002-2972	33	2004-511	24	2009-115	40	2016-499	21
2002-557	25	2002-2974	33	2004-541	24	2009-130	16		
2002-558	25	2002-2991	33	2004-549	18	2009-130	19	2016-1201	21
2002-559	25	2002-2992	33	2004-549	24	2009-130	20	2016-1202	21
2002-560	25			2004-552	25	2009-130	21	2016-1204	21
		2002-3201	27	2004-553	25	2009-130	24	2016-1207	21
2002-1201	17	2002-3203	27	2004-554	25	2009-130	25	2016-1207	28
2002-1202	17	2002-3204	27	2004-555	25	2009-130	26	2016-1291	21
2002-1204	17	2002-3207	27			2009-130	27	2016-1292	21
2002-1207	17	2002-3208	27	2004-1201	18	2009-130	40	2016-1301	21
2002-1291	16	2002-3209	27	2004-1202	18	2009-174	16	2016-1302	21
2002-1291	17	2002-3211/1000-410	36	2004-1204	18	2009-174	17	2016-1304	21
2002-1292	16	2002-3211/1000-411	36	2004-1207	18	2009-174	18	2016-1307	21
2002-1292	17	2002-3211/1000-675	36	2004-1291	18	2009-174	19	2016-1391	21
2002-1301	17	2002-3211/1000-676	36	2004-1292	18	2009-174	21	2016-1392	21
2002-1302	17	2002-3212/1000-673	37	2004-1301	18	2009-174	22		
2002-1304	17	2002-3212/1000-674	37	2004-1302	18	2009-174	23	2016-7111	30
2002-1307	17	2002-3217	27	2004-1304	18	2009-174	28	2016-7114	28
2002-1391	16	2002-3218	27	2004-1307	18	2009-174	31	2016-7114	30
2002-1391	17	2002-3221/1000-413	37	2004-1391	18	2009-174	32	2016-7192	30
2002-1392	16	2002-3221/1000-434	37	2004-1392	18	2009-174	33		
2002-1491	16	2002-3227	27	2004-1401	18	2009-182	16		
2002-1492	16	2002-3228	27	2004-1402	18	2009-182	17	Series ...	
2002-1601	31	2002-3231	27	2004-1404	18	2009-182	18	.../000-02	39
2002-1602	31	2002-3233	27	2004-1407	18	2009-182	19	.../000-05	39
2002-1604	31	2002-3234	27	2004-1491	18	2009-182	20	.../000-06	39
2002-1671	31	2002-3237	27	2004-1492	18	2009-182	21	.../000-07	39
2002-1672	31	2002-3238	27			2009-182	22	.../000-12	39
2002-1674	31	2002-3239	27	Series 2005		2009-182	23	.../000-17	39
2002-1691	31	2002-3247	27	2005-115	32	2009-182	28	.../000-23	39
2002-1692	17	2002-3248	27			2009-182	31	.../000-24	39
2002-1692	31	2002-3257	27			2009-182	32		
2002-1692	31	2002-3258	27	2005-7641	29	2009-182	33		
2002-1801	32	2002-3291	27	2005-7642	29	2009-191	41		
2002-1802	32	2002-3291	36	2005-7645	29	2009-192	41		
2002-1804	32	2002-3291	37	2005-7646	29	2009-193	41		
2002-1871	32	2002-3292	27	2005-7649	29	2009-196	41		
2002-1872	32	2002-3292	36						
2002-1874	32	2002-3292	37	Series 2006		2009-304	28		
2002-1891	32			2006-115	19	2009-305	28		
2002-1892	32	2002-434	26						
						2009-412	23		
2002-2201	26	2002-6301	22	2006-402	19	2009-414	23		
2002-2202	26	2002-6302	22	2006-403	19	2009-416	23		
2002-2203	26	2002-6304	22	2006-404	19				
2002-2204	26	2002-6307	22	2006-405	19	Series 2010			
2002-2207	26	2002-6391	22	2006-433	19	2010-100	20		
2002-2208	26	2002-6392	22	2006-434	19	2010-174	20		
2002-2209	26	2002-6401	22	2006-435	19				
2002-2211/1000-410	34	2002-6402	22	2006-499	19				
2002-2211/1000-411	34	2002-6404	22			2010-402	20		
2002-2213/1000-487	35	2002-6407	22	2006-549	24	2010-403	20		
2002-2213/1000-488	35					2010-404	20		
2002-2214/1000-489	35	2002-7111	30	2006-1201	19	2010-405	20		
2002-2214/1000-490	35	2002-7114	30	2006-1202	19	2010-433	20		
2002-2214/1000-491	34	2002-7192	30	2006-1204	19	2010-434	20		
2002-2214/1000-492	34			2006-1207	19	2010-435	20		
2002-2217	26			2006-1291	19				
2002-2221/1000-413	35	Series 2003		2006-1292	19	2010-1201	20		
2002-2221/1000-434	35	2003-7641	28	2006-1301	19	2010-1202	20		
2002-2227	26	2003-7642	28	2006-1302	19	2010-1204	20		
2002-22292	35	2003-7645	28	2006-1304	19	2010-1207	20		
2002-2231	26	2003-7646	28	2006-1307	19	2010-1291	20		
2002-2232	26	2003-7649	28	2006-1391	19	2010-1292	20		
2002-2233	26	2003-7692	28	2006-1392	19	2010-1301	20		
2002-2234	26			2006-7111	30	2010-1302	20		
2002-2237	26	Series 2004		2006-7114	30	2010-1304	20		
2002-2238	26	2004-115	18	2006-7192	30	2010-1307	20		
2002-2239	26	2004-171	18			2010-1391	20		
2002-2247	26	2004-172	18	Series 2009		2010-1392	20		
2002-2257	26			2009-110	16				
2002-2291	26			2009-110	19	Series 2016			
2002-2291	34	2004-402	18	2009-110	20	2016-100	21		
2002-2291	35	2004-403	18	2009-110	21	2016-115	21		
2002-2292	26	2004-404	18						



51179940 · 0888-0164/0200-3601 · TOPJOB® S 2.0 · E · 10/06 · JA 61049 · Printed in Germany · Subject to design changes 4 045454 376291

WAGO Kontakttechnik GmbH & Co. KG
P.O. Box 28 80 · 32385 Minden
Hansastraße 27 · 32423 Minden
Germany
Phone +49 571/8 87-0
Fax +49 571/8 87-169
info@wago.com
www.wago.com



X-ON Electronics

Largest Supplier of Electrical and Electronic Components

Click to view similar products for [Accessories for Robotics and RC](#) category:

Click to view products by [Wago](#) manufacturer:

Other Similar products are found below :

[56T705](#) [015-9516-002](#) [01.001.6453.0](#) [641763-8](#) [CW106-01X](#) [CW30101A](#) [CW31701A](#) [D2041839](#) [70.352.0628.0](#) [73.353.4028.1](#) [FB22001A](#)
[FB30601A](#) [9009030000](#) [9501](#) [121587-0026](#) [1218510-1](#) [1218629-4](#) [1218630-4](#) [1261000A00M001](#) [128-26-5](#) [RFI77-14](#) [1367251-2](#) [14](#) [1-](#)
[449604-1](#) [1460g4](#) [1470g4](#) [DV0PM20034](#) [MS27488-16-1](#) [MS3057-12A W/B](#) [MS3057-8A-624](#) [MS600-2-XP-1A](#) [MS-602-GEE-14-07C](#)
[MS603-12-01A](#) [MS90376-14R](#) [MS90376-16RB](#) [MTB1-11PH3](#) [1676610000](#) [1A9224 REV A](#) [210-115](#) [CA20L22](#) [2227383-1](#) [225-0090-000](#)
[225-0098-000](#) [KA-89-82](#) [CB20201X](#) [KC-89-104](#) [CB30601A](#) [CB31201A](#) [236-600](#) [CBC120210-752](#)