

Characteristics

Control relays

K mini-control relays

Environment

Conforming to standards Approvals		IEC/EN 60947-1, 60947-5-1, NF C 63-140, VDE 0660 UL, CSA, DEMKO, NEMKO, SEMKO			
Operating position		Without derating Without derating Possible positions for CA2-K only, with derating, call our Customer information centre on 0870 608 8 608.			
Connection					
Screw clamp connections	Solid cable	mm ²	Min 1 x 1.5	Max 2 x 4	Max to IEC/EN 60947 1 x 4 + 1 x 2.5
	Flexible cable without cable end	mm ²	1 x 0.75	2 x 4	2 x 2.5
	Flexible cable with cable end	mm ²	1 x 0.34	1 x 1.5 + 1 x 2.5	1 x 1.5 + 1 x 2.5
Spring terminal connections	Solid cable	mm ²	1 x 0.75	1 x 1.5	2 x 1.5
	Flexible cable without cable end	mm ²	1 x 0.75	1 x 1.5	2 x 1.5
Faston connectors	Clip	mm	2 x 2.8 or 1 x 6.35		
Solder pins for printed circuit board	With locating device between power circuit and control circuit		4 mm x 35 microns		
Tightening torque	Philips head n° 2 and Ø 6	N.m	0.8...1.3		
Terminal referencing	Conforming to standards EN 50005 and EN 50011		Up to 8 contacts		
Protective treatment	Conforming to IEC/EN 60068 (DIN 50016)		"TC" (Klimafest, Climateproof)		
Degree of protection	Conforming to VDE 0106		Protection against direct finger contact (devices with screw clamp terminals or pins for printed circuit board)		
Ambient air temperature around the device	Storage	°C	- 50...+ 80		
	Operation	°C	- 25...+ 50		
Maximum operating altitude	Without derating	m	2000		
Vibration resistance	Control relay open		2 gn		
5...300 Hz	Control relay closed		4 gn		
Flame resistance	Conforming to UL 94		Self-extinguishing material V1		
	Conforming to NF F 16-101 and 16-102		Conforming to requirement 2		
Shock resistance	Control relay open		10 gn		
(half sine wave, 11 ms)	Control relay closed		15 gn		
Safe circuit separation	Conforming to VDE 0106 and IEC/EN 60536		VLSV (Very Low Safety Voltage), up to 400 V		

6

Control circuit characteristics

6.2

Type of control relay		CA2-K	CA3-K	CA4-K
Rated control circuit voltage (Uc)		V ~ 12...690	≡ 12...250	≡ 12...120
Control voltage limits (≤ 50 °C) single-voltage coil	For operation	0.8...1.15 Uc	0.8...1.15 Uc	0.7...1.3 Uc
	For drop-out	≤ 0.2 Uc	≤ 0.1 Uc	≤ 0.1 Uc
Mechanical durability at Uc In millions of operating cycles	50/60 Hz coil	10	–	–
	Standard ≡ coil	–	20	–
	Wide range, low consumption ≡ coil	–	–	30
Maximum operating rate	In operating cycles per hour	10,000	10,000	6000
Average consumption at 20 °C and at Uc	Inrush	30 VA	3 W	1.8 W
	Sealed	4.5 VA	3 W	1.8 W
Heat dissipation		W 1.3	3	1.8
Operating time at 20 °C and at Uc	Between coil energisation and - opening of the N/C contacts - closing of the N/O contacts	ms 5...15 ms 10...20	25...35 30...40	25...35 30...40
	Between coil de-energisation and - opening of the N/O contacts - closing of the N/C contacts	ms 10...20 ms 15...25	10 15	10...20 15...25
Maximum immunity to micro breaks		ms 2	2	2

References:
pages 6/10 and 6/11

Dimensions:
page 6/14

Schemes:
page 6/15

Characteristics

Control relays

K mini-control relays

Contact characteristics of mini-control relays and instantaneous contact blocks

Number of contacts	On CA●-K		4
	On LA1-K		2 or 4 for CA2-K and CA3-K: 2 for CA4-K
Rated operational voltage (Ue)	Up to	V	690
Rated insulation voltage (Ui)	Conforming to IEC/EN 60947-1, IEC/EN 60947-5-1	V	690
	Conforming to VDE 0110 group C	V	750
	Conforming to CSA C 22-2 n° 14	V	600
Conventional thermal current (Ith)	For ambient temperature ≤ 50 °C	A	10
Operational current frequency		Hz	Up to 400
Minimum switching capacity	U min (DIN 19 240)	V	17
	I min	mA	5
Short-circuit protection	Conforming to IEC/EN 60947-1 & VDE 0660, gG fuse	A	10
Rated making capacity	Conforming to IEC/EN 60947-1 I rms	A	110
Overload current	Permissible for	1 s	A 80
		500 ms	A 90
		100 ms	A 110
Insulation resistance		MΩ	> 10
Make before break distance	CA●-K and LA1-K : linked contacts as per INRS, BIA and CNA specifications	mm	0.5 (see schemes, page 6/15)

Operational power of contacts
Conforming to IEC/EN 60947-5-1

a.c. supply, category AC-15

Electrical durability (valid up to 3600 operating cycles per hour) on an inductive load such as the coil of an electromagnet: making current (cos φ 0.7) = 10 times breaking current (cos φ 0.4).

	24	48	110/127	220/230	380/400	440	600/690
V	48	96	240	440	800	880	1200
VA	17	34	86	158	288	317	500
VA	7	14	36	66	120	132	200
VA	1000	2050	5000	10,000	14,000	13,000	9000

1 million operating cycles
3 million operating cycles
10 million operating cycles
Occasional making capacity

- Breaking limit of contacts valid for:
 - maximum of 50 operating cycles at 10 s intervals (breaking current = making current x cos φ 0.7).
- Electrical durability of contacts for:
 - 1 million operating cycles (2a),
 - 3 million operating cycles (2b),
 - 10 million operating cycles (2c).
- Breaking limit of contacts valid for:
 - maximum of 20 operating cycles at 10 s intervals with current passing for 0.5 s per operating cycle.
- Thermal limit.

Power broken in VA

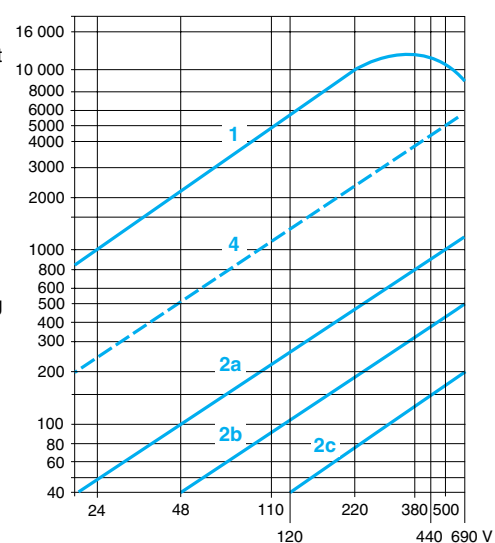

d.c. supply, category DC-13

Electrical durability (valid up to 1200 operating cycles per hour) on an inductive load such as the coil of an electromagnet, without economy resistor, the time constant increasing with the load.

	24	48	110	220	440	600
V	120	80	60	52	51	50
W	55	38	30	28	26	25
W	15	11	9	8	7	6
W	720	600	400	300	230	200

Power broken in W

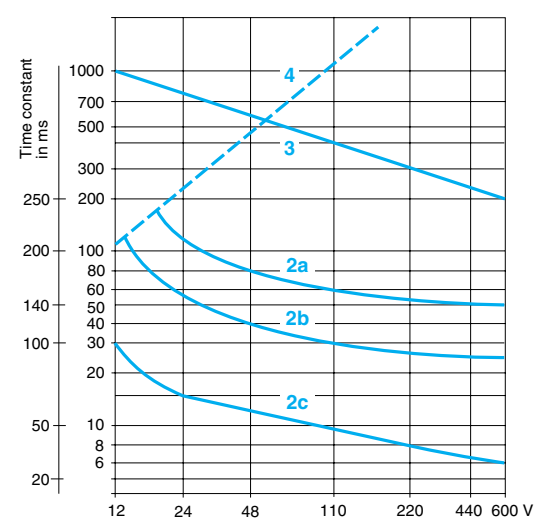

6

6.2

References:
page 6/12

Dimensions:
page 6/14

Schemes:
page 6/15

Schneider Electric

Telemecanique

6/9

References

Control relays

K mini-control relays
For control circuit: a.c. or d.c.

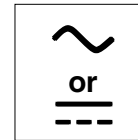

Mini-control relays for a.c. control circuit



CA2-KN40●●

- Mounted on 35 mm rail or Ø 4 screw fixing.
- Screws in open "ready-to-tighten" position.

Control circuit	Auxiliary contacts	Basic reference. Complete with code indicating control circuit voltage (1)	Weight
			kg

Consumption

Screw clamp connections

4.5 VA			
	4	–	CA2-KN40●● 0.180
	3	1	CA2-KN31●● 0.180
	2	2	CA2-KN22●● 0.180

Spring terminal connections

4.5 VA			
	4	–	CA2-KN403●● 0.180
	3	1	CA2-KN313●● 0.180
	2	2	CA2-KN223●● 0.180

Faston connectors, 1 x 6.35 or 2 x 2.8

4.5 VA			
	4	–	CA2-KN407●● 0.180
	3	1	CA2-KN317●● 0.180
	2	2	CA2-KN227●● 0.180

Solder pins for printed circuit boards

4.5 VA			
	4	–	CA2-KN405●● 0.210
	3	1	CA2-KN315●● 0.210
	2	2	CA2-KN225●● 0.210

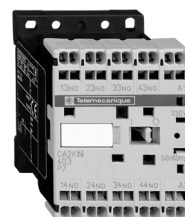

CA2-KN403●●

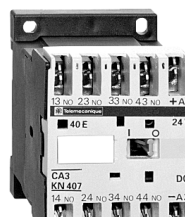

CA3-KN407●●

Mini-control relays for d.c. control circuit

- Mounted on 35 mm rails or Ø 4 screw connections.
- Screws in open "ready-to-tighten" position.

Screw clamp connections

3 W			
	4	–	CA3-KN40●● 0.225
	3	1	CA3-KN31●● 0.225
	2	2	CA3-KN22●● 0.225

Spring terminal connections

3 W			
	4	–	CA3-KN403●● 0.225
	3	1	CA3-KN313●● 0.225
	2	2	CA3-KN223●● 0.225

Faston connectors, 1 x 6.35 or 2 x 2.8

3 W			
	4	–	CA3-KN407●● 0.225
	3	1	CA3-KN317●● 0.225
	2	2	CA3-KN227●● 0.225

Solder pins for printed circuit boards

3 W			
	4	–	CA3-KN405●● 0.255
	3	1	CA3-KN315●● 0.255
	2	2	CA3-KN225●● 0.255

(1) Standard control circuit voltages (for other voltages, please call our Customer information centre on 0870 608 8 608).

Control relays CA2-K (0.8...1.15 Uc) (0.85...1.1 Uc)

Volts ~	12	20	24(2)	36	42	48	110	115	127	220/	230	230/	380/	400	400/	440	500	660/
50/60 Hz										230		240	400		415			690
Code	J7	Z7	B7	C7	D7	E7	F7	FE7	FC7	M7	P7	U7	Q7	V7	N7	R7	S7	Y7

Up to and including 240 V, coil with integral suppression device available: add 2 to the code required. Example: **J72**

Control relays CA3-K (0.8...1.15 Uc)

Volts ---	12	20	24(2)	36	48	60	72	100	110	125	200	220	230	240	250
Code	JD	ZD	BD	CD	ED	ND	SD	KD	FD	GD	LD	MD	MPD	MUD	UD

Coil with integral suppression device available: add 3 to the code required. Example: **JD3**.

(2) When connecting an electronic sensor or timer in series with the coil of the control relay, select a 20 V coil (~ control voltage code Z7, --- control circuit voltage code ZD) so as to compensate for the incurred voltage drop.

Characteristics:
pages 6/8 and 6/9

Dimensions:
page 6/14

Schemes:
page 6/15

References

Control relays

K mini-control relays
For control circuit: a.c. or d.c.

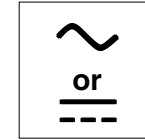

CA4-KN40●●●

Low consumption mini-control relays (a.c. control circuit)

- Mounted on 35 mm rail or Ø 4 screw fixing.
- Screws in open "ready-to-tighten" position.

Control circuit	Auxiliary contacts	Basic reference. Complete with code indicating control circuit voltage (1)	Weight
Consumption			kg
Screw clamp connections			
1.8 W	4 -	CA4-KN40●●	0.235
	3 1	CA4-KN31●●	0.235
	2 2	CA4-KN22●●	0.235
Spring terminal connections			
1.8 W	4 -	CA4-KN403●●	0.235
	3 1	CA4-KN313●●	0.235
	2 2	CA4-KN223●●	0.235
Faston connectors, 1 x 6.35 or 2 x 2.8			
1.8 W	4 -	CA4-KN407●●	0.235
	3 1	CA4-KN317●●	0.235
	2 2	CA4-KN227●●	0.235
Solder pins for printed circuit boards			
1.8 W	4 -	CA4-KN405●●	0.265
	3 1	CA4-KN315●●	0.265
	2 2	CA4-KN225●●	0.265

(1) Standard control circuit voltages (for other voltages, please call our Customer information centre on 0870 608 8 608).

Control relays CA4-K (Wide range coil: 0.7...1.3 Uc)							
Volts ~	12	20	24	48	72	110	120
Code	JW3	ZW3	BW3	EW3	SW3	FW3	GW3

6

6.2

References

Control relays

K mini-control relays
Instantaneous and time delay auxiliary contact blocks



Instantaneous auxiliary contact blocks

Clip-on front mounting, 1 block per control relay

Type of connection	Composition	Reference	Weight
			kg
Screw clamp	2 -	LA1-KN20	0.045
	- 2	LA1-KN02	0.045
	1 1	LA1-KN11	0.045
	4 -	LA1-KN40 (1)	0.045
	3 1	LA1-KN31 (1)	0.045
	2 2	LA1-KN22 (1)	0.045
	1 3	LA1-KN13 (1)	0.045
	- 4	LA1-KN04 (1)	0.045
Spring terminal	2 -	LA1-KN203	0.045
	- 2	LA1-KN023	0.045
	1 1	LA1-KN113	0.045
	4 -	LA1-KN403 (1)	0.045
	3 1	LA1-KN313 (1)	0.045
	2 2	LA1-KN223 (1)	0.045
	1 3	LA1-KN133 (1)	0.045
	- 4	LA1-KN043 (1)	0.045
Faston connectors 1 x 6.35 or 2 x 2.8	2 -	LA1-KN207	0.045
	- 2	LA1-KN027	0.045
	1 1	LA1-KN117	0.045
	4 -	LA1-KN407 (1)	0.045
	3 1	LA1-KN317 (1)	0.045
	2 2	LA1-KN227 (1)	0.045
	1 3	LA1-KN137 (1)	0.045
	- 4	LA1-KN047 (1)	0.045

Electronic time delay contact blocks

- Relay output with common point changeover contact, \sim or \equiv 240 V, 2 A maximum
- Control voltage: 0.85...1.1 U_c
- Maximum switching capacity: 250 VA or 150 W
- Operating temperature: - 10...+ 60 °C
- Reset time: 1.5 s during the time delay period, 0.5 s after the time delay period

Clip-on front mounting, 1 block per control relay

Voltage	Type	Timing range	Composition	Reference	Weight
					kg
\sim or \equiv 24...48	On-delay	1...30	1	LA2-KT2E	0.040
\sim 110...240	On-delay	1...30	1	LA2-KT2U	0.040

For other electronic timers type RE7, see pages 6/26 to 6/34.

(1) Block of 4 contacts for use only on CA2-K and CA3-K



6

6.2

References

Control relays

K mini-control relays
Suppressor modules
Mounting and marking accessories

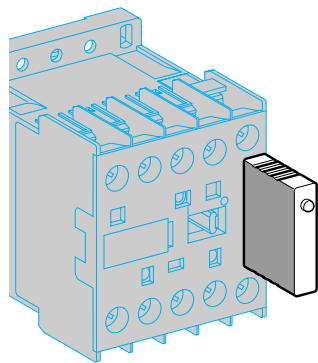

LA4-K●●●

Suppressor modules incorporating LED indicator

Mounting and connection	Type	For voltages	Sold in lots of	Unit reference	Weight kg
Clips onto front of relay with locating device. No tools required for connection.	Varistor (1)	~ and --- 12...24 V	5	LA4-KE1B	0.010
		~ and --- 32...48 V	5	LA4-KE1E	0.010
		~ and --- 50...129 V	5	LA4-KE1FC	0.010
		~ and --- 130...250 V	5	LA4-KE1UG	0.010
	Diode + Zener diode (2)	--- 12...24 V	5	LA4-KC1B	0.010
		--- 32...48 V	5	LA4-KC1E	0.010
	RC (3)	~ 220...250 V	5	LA4-KA1U	0.010

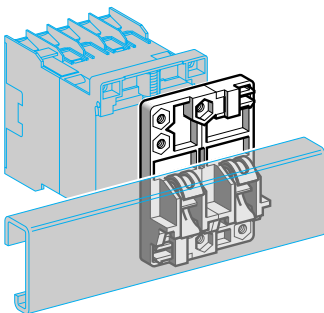

LA9-D973

Mounting accessories

Description	Application		Sold in lots of	Unit reference	Weight kg
Mounting plates	On 1 rail	Clip-on fixing	1	LA9-D973	0.025
	On 2 rails	110/120 mm fixing centres	10	DX1-AP25	0.065

Marking accessories

Description	Application		Sold in lots of	Unit reference	Weight kg
Marker holder	Clip-on fixing on front face	—	100	LA9-D90	0.001
Clip-in markers	4 maximum per relay	Strips of 10 identical numbers 0 to 9	25	AB1-R● (4)	0.002
		Strips of 10 identical capital letters A to Z	25	AB1-G● (4)	0.002

- (1) Protection by limitation of the transient voltage to 2 Uc max. Maximum reduction of transient voltage peaks. Slight time delay on drop-out (1.1 to 1.5 times the normal time).
 (2) No overvoltage or oscillation frequency. Polarised component. Slight time delay on drop-out (1.1 to 1.5 times the normal time).
 (3) Protection by limitation of the transient voltage to 3 Uc max and limitation of the oscillation frequency. Slight time delay on drop-out (1.2 to 2 times the normal time).
 (4) Complete the reference by replacing the ● with the required character.

Dimensions:
page 6/14

Schneider Electric

Telemecanique

6/13

6

6.2

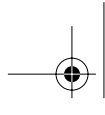

Dimensions, mounting

Control relays K mini-control relays

Mini-control relays CA2-K, CA3-K, CA4-K On panel

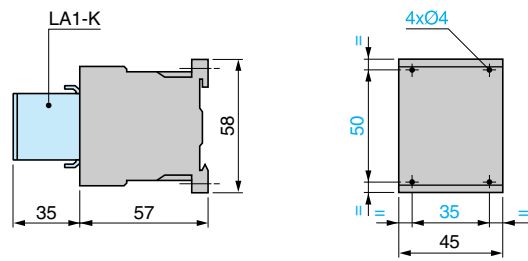

On printed circuit board

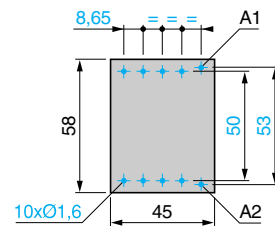

Contactors pins Ø 1.55

On mounting rail AM1-DP200 or AM1-DE200 (L= 35 mm)



On asymmetrical rail with clip-on mounting plates LA9-D973

6

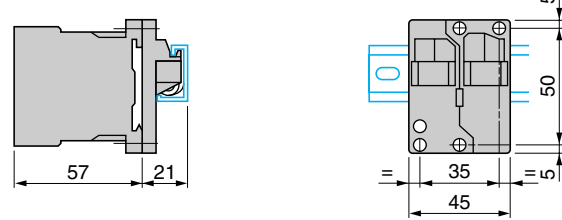

DX1-AP25

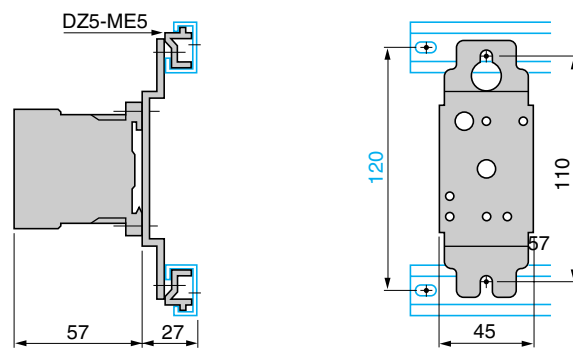

6.2

Electronic time delay contact blocks LA2-KT



Suppressor modules LA4-K



On mini-control relay

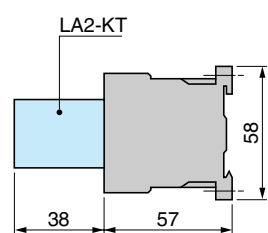

On mini-control relay

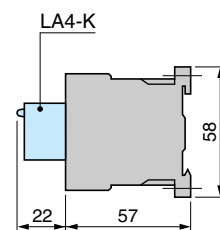

Characteristics:
pages 6/8 and 6/9

References:
pages 6/10 to 6/13

Schemes:
page 6/15

6/14

Telemecanique

Schneider Electric

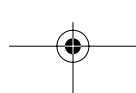

Schemes

Control relays

K mini-control relays

Mini-control relays CA2-K, CA3-K, CA4-K

4 N/O

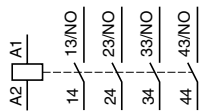

3 N/O + 1 N/C

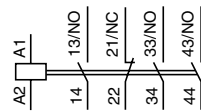

2 N/O + 2 N/C

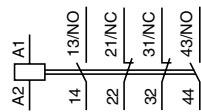

With integral suppression device CA4-K

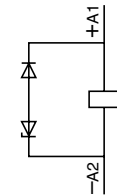

Instantaneous auxiliary contact blocks LA1-K for CA2-K, CA3-K, CA4-K

2 N/O
LA1-KN20
LA1-KN207

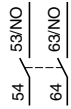

2 N/C
LA1-KN02
LA1-KN027



1 N/O + 1 N/C
LA1-KN11
LA1-KN117

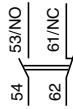

for CA2-K, CA3-K

4 N/O
LA1-KN40
LA1-KN407



3 N/O + 1 N/C
LA1-KN31
LA1-KN317

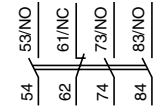

2 N/O + 2 N/C
LA1-KN22
LA1-KN227

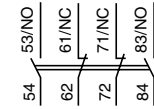

1 N/O + 3 N/C
LA1-KN13
LA1-KN137

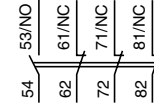

4 N/C
LA1-KN04
LA1-KN047

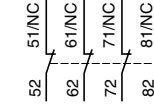

Electronic time delay contact blocks LA2-KT for CA2-K, CA3-K, CA4-K

1 C/O
LA2-KT2

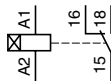

Suppressor modules LA4-KC LA4-KE

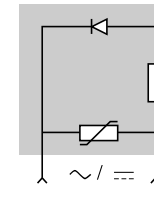
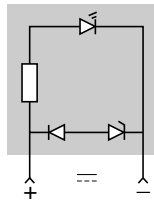

6

6.2

X-ON Electronics

Largest Supplier of Electrical and Electronic Components

Click to view similar products for [Solid State Relays - Industrial Mount](#) category:

Click to view products by [Schneider](#) manufacturer:

Other Similar products are found below :

[6225XXASRS-DC3](#) [D2440-C](#) [H10CA4890](#) [D4875C](#) [D53TP50DH-10](#) [1395831-1](#) [1616010-6](#) [BR312BY](#) [A-1326](#) [AQY210SXE01](#)
[AQY221N2SYD01](#) [AQY414SXE01](#) [26532764](#) [H10CA4850](#) [H12CA4890VL](#) [RA2410-D06](#) [D1202F](#) [D53TP50-10](#) [W230E-1-12](#) [W230T-3-](#)
[12](#) [W6125ASX-1](#) [W6225DSX-2](#) [W6240DSX-4](#) [W6240DTX-2](#) [1-1617030-3](#) [1-1617033-9](#) [1-1617033-7](#) [MS2-D2420](#) [MS2-D2430](#) [A-1440](#)
[4-1617080-0](#) [RJ1P60V50E](#) [RN1F48I50](#) [70.362.1028.0](#) [7-1393030-8](#) [Z5.509.0828.0](#) [W230E-2-5](#) [G3RV-SR700-D](#) [AC110](#) [G3RV-SR500-AL](#)
[AC100](#) [G3RV-SR500-D](#) [ACDC24](#) [G3RV-SR500-AL](#) [ACDC24](#) [G3RV-SR700-D](#) [ACDC24](#) [G3RV-SR700-AL](#) [ACDC24](#) [G3RV-SR500-D](#)
[DC12](#) [G3RV-SR700-A](#) [ACDC24](#) [G3RV-SR500-A](#) [ACDC24](#) [2912138](#) [2912141](#) [SSRDAC10](#) [1613353](#)