

Amphenol® LTW® Innovation in Waterproof Solution



NMEA 2000 Marine Network Solutions

www.ltw-tech.com
www.amphenolltw.com

Marine Electronics System



• NMEA 2000 Product Certificate •



NMEA 2000 Mini Cable and Connector



NMEA 2000 Micro Cable and Connector

2 Marine Network Cable Guide

Amphenol® LTW®

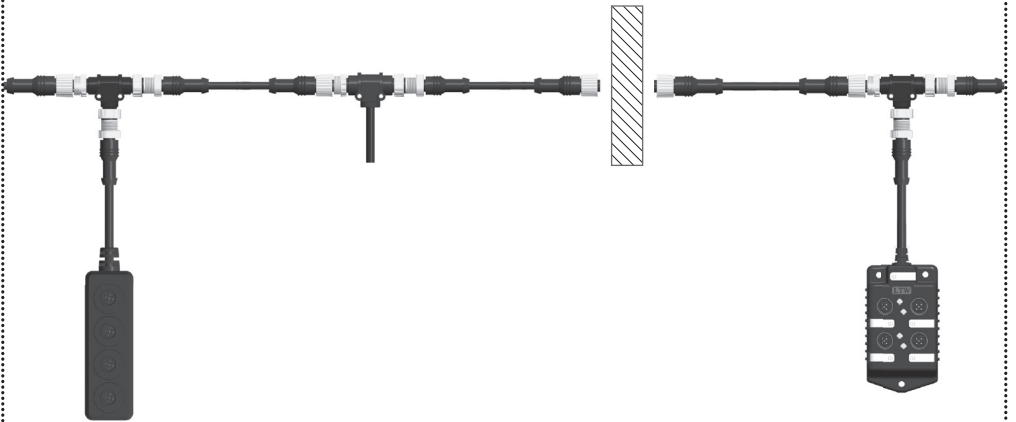

Features: Marine Network Cable

- ▶ Provides easy installation for fast and reliable connection
- ▶ Ensures high performance and signaling
- ▶ Designed for the marine environment
- ▶ Various options of connector type is available to support all system requirements

About NMEA 2000

LTW Technology expands its coverage targeting the marine industry that features the NMEA 2000 standard.

The NMEA 2000 standard contains the requirements of a serial data communications network to inter-connect marine electronic equipment on vessels. It is multi-master and self-configuring, and there is no central network controller. Equipment designed to this standard will have the ability to share data, including commands and status with other compatible equipment over a single channel.

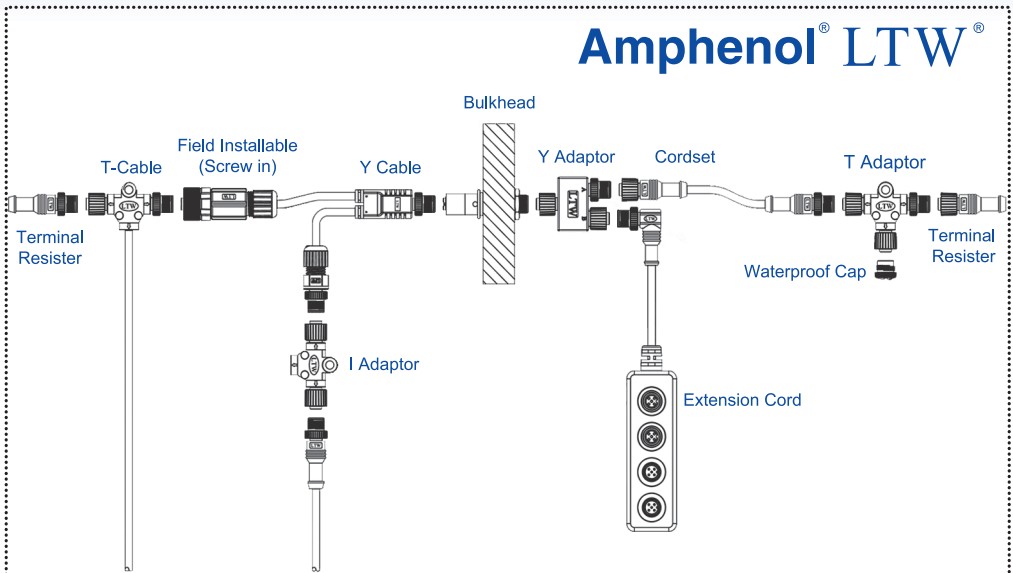

From the finest products supporting numerous connector applications worldwide. LTW introduces the advanced and most comprehensive connector and cabling solution for the Marine Industry.

We made it possible to simplify your system needs and promote convenience with cost effective offer and wide array of waterproof connector choices featuring LTW Marine Network Cable Guide.

This guide contains the requirements of a serial data communications network to inter-connect marine electronic equipment on vessels. Equipment designed to this system will have the ability to share data, including commands and status with other compatible equipment over a single channel. It also introduces Micro series connector and accessories available in plastic and metal version specially designed to fit marine requirements.

All of these products are made with quality, enhanced performance and highly reliable. Discover this and more as we introduce you LTW Marine Network Cable Guide.

XXX - XX X X X X - X X X XXX

Number of Contacts

- 02, 03, Pin

Style

- A – For Cable with S/R
- B – For Cable without S/R
- P – For Panel

Specification

- MN – Mini Size Current Rating 8A (NMEA Non Approval)
- MC – Micro Size Current Rating 4A (NMEA Non Approval)
- MNP – Mini Plastic Size Current Rating 8A (NMEA Non Approval)
- MCP – Micro Plastic Size Current Rating 4A (NMEA Non Approval)
- MNL – Mini Size LED Current Rating 8A (NMEA Non Approval)
- UMN – Mini Size Current Rating 8A (NMEA 30u"Approval Product)
- UMC – Micro Size Current Rating 4A (NMEA 30u"Approval Product)
- UMCP – Micro Plastic Size Current Rating 4A (NMEA 30u"Approval Product)

Connector Style

- M – Male Connector
- F – Female Connector

Contact Type

- M – Male
- F – Female

Assemble Style

- M – Molding Type
- A – Assembly Type (Solder)
- B – Assembly Type (Screw type)
- P – For Panel
- T – Termination Resistor

Back Shell

- L – Straight (180° For Cable Type)
- R – Right Angle (90° For Cable Type)
- C – Circular (For Panel Type)
- F – Front Hexagonal (For Panel Type)

Waterproof Rating

- 5 = IP 65
- 6 = IP 66
- 7 = IP 67
- 8 = IP 68

Mating Style

- L – Lock
- S – Screw
- Q – Quick

Version

- 000 : Phantom without Cable
- Without Cable
001, 002,
- For Cable
A01 - 1M ~ A99 - 99M

NMEA Non Approval

- A – Cable 22+24+B PVC for NMEA Micro
- B – Cable 18+22+B PVC for NMEA Micro
- C – Cable 16+18+B PVC for NMEA Mini
- D – Cable 16AWG 4C PVC for NMEA Mini

NMEA Non Approval

- A – Device Net Cable 22+24+B PVC for NMEA Micro Approval Product
- C – Device Net Cable 15+18+B PVC for NMEA Mini Approval Product

XX - XX XX XX - XXX - X X XXX

Specification

- AA – Mini Size Adaptor
- BA – Standard Size Adaptor
- RJ – RJ Unshield Connector Adaptor
- RS – RJ Shielded Connector Adaptor
- UB – USB Connector Adaptor
- 13 – 1394 Connector Adaptor
- TN – TNC Connector Adaptor
- SM – M8 Sensor Connector Adaptor
- SS – M12 Sensor Connector Adaptor
- PS – Plastic M12 Sensor Connector Adaptor
- SB – M12 Sensor B-Coded Connector Adaptor
- PB – Plastic M12 Sensor D-Coded Connector Adaptor
- SD – M12 Sensor B-Coded Connector Adaptor
- PD – Plastic M12 Sensor D-Coded Connector Adaptor
- SI – M12 Sensor I-Style Connector Adaptor
- PI – Plastic M12 Sensor I-Style Connector Adaptor
- MN – Mini Adaptor (NMEA Non Approval)
- MC – Micro Adaptor (NMEA Non Approval)
- NC – Mini- Micro Adaptor (NMEA Non Approval)
- PN – Plastic Mini Adaptor (NMEA Non Approval)
- PC – Plastic Micro Adaptor (NMEA Non Approval)
- PO – Plastic Mini - Micro Adaptor (NMEA Non Approval)
- SL – Solar Adaptor
- GA – I Adaptor
- UMN – Mini Adaptor (NMEA 30u"Approval Product)
- UMC – Micro Adaptor (NMEA 30u"Approval Product)
- UNC – Mini - Micro Adaptor (NMEA 30u"Approval Product)
- UPC – Plastic Micro Adaptor (NMEA 30u"Approval Product)

Mating Style

- L – Lock
- S – Screw
- C – Combo
- Q – Quick

Style

- I – I adaptor
- T – T adaptor
- Y – Y adaptor
- C – Double-Connector with Cable
- B – BulkHead
- E – Elbow

Version

- Without Cable
001, 002,
 - For Cable
A01 - 1M ~ A99 - 99M
- NMEA Non Approval**
- A – Cable 22+24+B PVC For NMEA Micro
 - B – Cable 18+22+B PVC For NMEA Micro
 - C – Cable 16+18+B PVC For NMEA Mini
- NMEA Approval**
- A – Device Net cable 22+24+B PVC for NMEA Micro Approval Product
 - C – Device Net cable 15+18+B PVC for NMEA Mini Approval Product

No. of Contacts for End 1, 2, 3

- 00, 00, 00 – RJ, USB, TNC, 1394, Solar
 - 00, XX, XX – I Adaptor
(Circular and Sensor Connector Only)
 - XX, XX, XX – T, Y Adaptor
(Circular and Sensor Connector Only)
- XX=
- 02 ~ 03 – for Mini Size (5A)
 - 04 ~ 06 – for Mini Size (2A)
 - 02 ~ 08 – for Standard Size (5A)
 - 10 ~ 12 – for Standard Size (2A)
 - 02 ~ 04 – for Standard Size (10A)
 - 03 ~ 05 – for Sensor Connector A, B, D-Coded (5A)
 - 06 ~ 08 – for Sensor Connector A, B, D-Coded (2A)
 - 04 ~ 05 – for Sensor Connector I-Style
 - 05 – for NMEA Connector

Connector + Pin Gender for End 1,2,3

- 0, X, X – I Adaptor
 - X, X, X – T, Y Adaptor
- X=
- M – Male + Male
 - F – Female + Female
 - H – Male + Female
 - B – Female + Male
 - RJ=
 - MM – Plug
 - FF – Jack

6 How to Order: Extension Cord & Adaptor

X - XXXXXX - XXXXXX - X XXX

Specification

- A – Mini Size Adaptor
- B – Standard Size Adaptor
- S – M12 Sensor Adaptor
- M – M8 Sensor Adaptor
- N – NMEA2000 Mini-C Adaptor (NMEA Non Approval)
- E – NMEA2000 Micro-C Adaptor (NMEA 30u"Approval Product)
- U – NMEA2000 Mini-C Adaptor (NMEA 30u"Approval Product)

Mating Style

- L – Lock
- S – Screw

Version

- 000 : Phantom Without Cable
 - Without Cable
001, 002,
 - For Cable
A01 – 1M ~ A99 – 99M
- NMEA Non Approval**
- A – Cable 22+24+B PVC for NMEA Micro
 - B – Cable 18+22+B PVC for NMEA Micro
 - C – Cable 16+18+B PVC for NMEA Mini
- NMEA Approval**
- A – Device Net cable 22+24+B PVC for NMEA Micro Approval Product
 - C – Device Net cable 15+18+B PVC for NMEA Mini Approval Product

No. of Contacts for Connector 1, 2, 3, 4, 5, 6

- 1, 2, 3, 4, 0–All Conn.
5, 6–Mini Size, Sensor M12, M8 Connector
- 2~3 – for Mini Size (5A)
 - 4~6 – for Mini Size (2A)
 - 2~8 – for Standard Size (5A)
 - 2~4 – for Standard Size (10A)
 - 3~5 – for Sensor Conn. A, B, D-Coded (5A)
 - 6~8 – for Sensor Conn. A, B, D-Coded (2A)
 - 4~5 – for Sensor Conn. I-Style
 - XXXXXX - Connector 1, 2, 3, 4, 5 and 6

Connector + Contacts Gender

- 1, 2, 3, 4, 0–All Conn.
1, 2, 3, 4, 5, 6–Connector
- M – Male + Male
 - F – Female + Female
 - H – Male + Female
 - B – Female + Male

INDEX

- 1. Metal Version: General Cable Assembly 8
- 2. Metal Version: Double Ended Cordset 16
- 3. Metal Version: T Cable Assembly 27
- 4. Metal Version: Bulkhead 33
- 5. Plastic Version: General Cable Assembly 36
- 6. Plastic Version: Double Ended Cordset 38
- 7. Plastic Version: T Cable Assembly 42

Cable Assembly		Mating Parts		Accessories
CONNECTOR	P/N	CONNECTOR	P/N	
	LTWMC-05BFFM-SL8△△XX FEATURES: <ul style="list-style-type: none"> • Molded with Cable • Screw Type • IP 68 • △ Available in A or B Cable 		LTWMC-05BMMM-SL8△△XX FEATURES: <ul style="list-style-type: none"> • Molded with Cable • Screw Type • IP 68 • △ Available in A or B Cable 	
			LTWMC-000505-0MM-CS△△XX FEATURES: <ul style="list-style-type: none"> • Double Conn. with Cable • Screw Type • IP 68 • △ Available in A or B Cable 	
			LTWMC-000505-0MF-CS△△XX FEATURES: <ul style="list-style-type: none"> • Double Conn. with Cable • Screw Type • IP 68 • △ Available in A or B Cable 	
			LTWSS-050505-△△△-TS001 FEATURES: <ul style="list-style-type: none"> • T Adaptor • Screw Type • △ Available in M, F, H or B Cable • IP 68 	
			LTWMC-050500-FM0-TSBXX FEATURES: <ul style="list-style-type: none"> • T Adaptor, T Cable • Screw Type • IP 68 	
			LTWMC-050500-MM0-TSBXX FEATURES: <ul style="list-style-type: none"> • T Adaptor, T Cable • Screw Type • IP 68 	
			LTW12-05BMMB-SL7001 FEATURES: <ul style="list-style-type: none"> • Field Installable • Screw Type • IP 67 	
			LTWMC-05PMMS-SH8001 FEATURES: <ul style="list-style-type: none"> • Panel Mount (Rear) • Screw Type • IP 68 	

Please Refer to "How to Order"

Cable Assembly		Mating Parts		Accessories
CONNECTOR	P/N	CONNECTOR	P/N	
	<p>LTWMC-05BFFM-SL8△XX</p> <p>FEATURES:</p> <ul style="list-style-type: none"> • Molded with Cable • Screw Type • IP 68 • △ Available in A or B Cable 		<p>LTWMC-05PMMS-SF8001</p> <p>FEATURES:</p> <ul style="list-style-type: none"> • Panel Mount (Front) • Screw Type • IP 68 	
			<p>LTWMC-000505-0FM-BS001</p> <p>FEATURES:</p> <ul style="list-style-type: none"> • Bulkhead • Screw Type • IP 68 	
			<p>LTWMC-000505-0FM-ES001</p> <p>FEATURES:</p> <ul style="list-style-type: none"> • T Adaptor (90°) • Screw Type • IP 68 	
			<p>LTWMC-000505-0MF-IS001</p> <p>FEATURES:</p> <ul style="list-style-type: none"> • I Adaptor (Inline Resistor) • Screw Type • IP 68 	
			<p>LTWS-555500-FFFM00-S001</p> <p>FEATURES:</p> <ul style="list-style-type: none"> • T Adaptor (2 Way Tee) • Screw Type • IP 68 	
			<p>LTWS-555555-FFFFFM-S001</p> <p>FEATURES:</p> <ul style="list-style-type: none"> • T Adaptor (4 Way Tee) • Screw Type • IP 68 	
	<p>LTWMC-05BMMM-SL8△XX</p> <p>FEATURES:</p> <ul style="list-style-type: none"> • Molded with Cable • Screw Type • IP 68 • △ Available in A or B Cable 		<p>LTWMC-05BFFM-SL8</p> <p>FEATURES:</p> <ul style="list-style-type: none"> • Molded with Cable • Screw Type • IP 68 • △ Available in A or B Cable 	
			<p>LTWMC-000505-0MF-CS</p> <p>FEATURES:</p> <ul style="list-style-type: none"> • Double Conn. with Cable • Screw Type • IP 68 • △ Available in A or B Cable 	

Please Refer to "How to Order"

Cable Assembly		Mating Parts		Accessories
CONNECTOR	P/N	CONNECTOR	P/N	
 <p>LTWMC-05BMMM-SL8  XX</p> <p>FEATURES:</p> <ul style="list-style-type: none"> • Molded with Cable • Screw Type • IP 68 •  Available in A or B Cable 		 <p>LTWMC-050500-FM0-TSBXX</p> <p>FEATURES:</p> <ul style="list-style-type: none"> • T Adaptor, T Cable • Screw Type • IP 68 		
		 <p>LTWMC-050500-FF0-TSBXX</p> <p>FEATURES:</p> <ul style="list-style-type: none"> • T Adaptor, T Cable • Screw Type • IP 68 		
		 <p>LTWSS-050505--TS001</p> <p>FEATURES:</p> <ul style="list-style-type: none"> • T Adaptor • Screw Type •  Available in M, F, H or B Cable • IP 68 		
		 <p>LWTW12-05BFFB-SL7001</p> <p>FEATURES:</p> <ul style="list-style-type: none"> • Field Installable • Screw Type • IP 67 		
		 <p>LTWMC-05PFFS-SH8001</p> <p>FEATURES:</p> <ul style="list-style-type: none"> • Panel Mount (Rear) • Screw Type • IP 68 		
		 <p>LTWMC-05PFFS-SF8001</p> <p>FEATURES:</p> <ul style="list-style-type: none"> • Panel Mount (Front) • Screw Type • IP 68 		
		 <p>LTWMC-000505-0FM-BS001</p> <p>FEATURES:</p> <ul style="list-style-type: none"> • Bulkhead • Screw Type • IP 68 		
		 <p>LTWMC-000505-0FM-ES001</p> <p>FEATURES:</p> <ul style="list-style-type: none"> • T Adaptor (90°) • Screw Type • IP 68 		

Please Refer to "How to Order"

Cable Assembly		Mating Parts		Accessories
CONNECTOR	P/N	CONNECTOR	P/N	
	<p>LTWMC-05BMMM-SL8ΔXX</p> <p>FEATURES:</p> <ul style="list-style-type: none"> • Molded with Cable • Screw Type • IP 68 • Δ Available in A or B Cable 		<p>LTWMC-000505-0MF-IS001</p> <p>FEATURES:</p> <ul style="list-style-type: none"> • I Adaptor (Inline Resistor) • Screw Type • IP 68 	
			<p>LTWS-555500-FFFM00-S001</p> <p>FEATURES:</p> <ul style="list-style-type: none"> • T Adaptor (2 Way Tee) • Screw Type • IP 68 	
			<p>LTWS-555555-FFFFFM-S001</p> <p>FEATURES:</p> <ul style="list-style-type: none"> • T Adaptor (4 Way Tee) • Screw Type • IP 68 	
			<p>LTWS-555500-FFFF00-SΔXX</p> <p>FEATURES:</p> <ul style="list-style-type: none"> • Extension Cord • Screw Type • IP 68 • Δ Available in A or B Cable 	
			<p>LTWUMC-000505-0MF-CSAXX</p> <p>FEATURES:</p> <ul style="list-style-type: none"> • Double Conn. with Cable • Screw Type • IP 68 	
	<p>LTWUMC-05BMMM-SL8AXX</p> <p>FEATURES:</p> <ul style="list-style-type: none"> • Molded with Cable • Screw Type • IP 68 when mated 		<p>LTWUMC-050505-FMF-TS001</p> <p>FEATURES:</p> <ul style="list-style-type: none"> • T Adaptor • Screw Type • IP 68 	
			<p>LTWUMC-05BFFB-SL7001</p> <p>FEATURES:</p> <ul style="list-style-type: none"> • Molded with Cable • Screw Type • IP 67 	
			<p>LTWUMC-000505-0FM-BS001</p> <p>FEATURES:</p> <ul style="list-style-type: none"> • Bulkhead • Screw Type • IP 67 	

Please Refer to "How to Order"

Cable Assembly		Mating Parts		Accessories
CONNECTOR	P/N	CONNECTOR	P/N	
	LTWUMC-05BMMM-SL8AXX FEATURES: <ul style="list-style-type: none"> • Molded with Cable • Screw Type • IP 68 		LTWE-555500-FFFM00-S001 FEATURES: <ul style="list-style-type: none"> • T Adaptor (2 Way Tee) • Screw Type • IP 68 	
			LTWE-555555-FFFFFM-S001 FEATURES: <ul style="list-style-type: none"> • T Adaptor(4 Way Tee) • Screw Type • IP 68 	
			LTWE-555500-FFFF00-SAXX FEATURES: <ul style="list-style-type: none"> • Extension Cord • Screw Type • IP 68 	
	LTWUMN-05AMMM-SL8CXX FEATURES: <ul style="list-style-type: none"> • Molded with Cable • Screw Type • IP 68 		LTWUMN-000505-0MF-CSCXX FEATURES: <ul style="list-style-type: none"> • Double Conn. with Cable • Screw Type • IP 68 	
			LTWUMN-050505-FMF-TS001 FEATURES: <ul style="list-style-type: none"> • T Adaptor • Screw Type • IP 67 	
			LTWUNC-050505-FMF-TS001 FEATURES: <ul style="list-style-type: none"> • T Adaptor • Screw Type • IP 67 	
			LTWUMN-000505-0FM-BS001 FEATURES: <ul style="list-style-type: none"> • Bulkhead • Screw Type • IP 67 	
			LTWUMN-05BFFB-SL7001 FEATURES: <ul style="list-style-type: none"> • Molded with Cable • Screw Type • IP 67 	

Please Refer to "How to Order"

Cable Assembly		Mating Parts		Accessories
CONNECTOR	P/N	CONNECTOR	P/N	
	LTWUMN-05AMMM-SL8CXX FEATURES: <ul style="list-style-type: none"> • Molded with Cable • Screw Type • IP 68 		LTWU-455000-MFF000-S001 FEATURES: <ul style="list-style-type: none"> • PowerTap Box • Screw Type • IP 68 	
	LTWMN-05AMMM-SL8CXX FEATURES: <ul style="list-style-type: none"> • Molded with Cable • Screw Type • IP 68 		LTWMN-05AFFM-SL8CXX FEATURES: <ul style="list-style-type: none"> • Molded with Cable • Screw Type • IP 68 	
			LTWMN-000505-0MF-CSCXX FEATURES: <ul style="list-style-type: none"> • Double Conn. with Cable • Screw Type • IP 68 	
			LTWMN-050505-FMF-TS001 FEATURES: <ul style="list-style-type: none"> • T Adaptor • Screw Type • IP 67 	
			LTWMN-050500-FM0-TSCXX FEATURES: <ul style="list-style-type: none"> • T Adaptor, T Cable • Screw Type • IP 68 	
			LTWNC-050505-FMF-TS001 FEATURES: <ul style="list-style-type: none"> • T Adaptor • Screw Type • IP 67 	
			LTWMN-000505-0FM-BS001 FEATURES: <ul style="list-style-type: none"> • Bulkhead • Screw Type • IP 68 	
			LTWMN-000505-0FM-ES001 FEATURES: <ul style="list-style-type: none"> • T Adaptor (90°) • Screw Type • IP 68 	

Please Refer to "How to Order"

Cable Assembly		Mating Parts		Accessories
CONNECTOR	P/N	CONNECTOR	P/N	
	LTWMN-05AMMM-SL8CXX FEATURES: <ul style="list-style-type: none"> • Molded with Cable • Screw Type • IP 68 		LTWMN-05BFFB-SL7001 FEATURES: <ul style="list-style-type: none"> • Molded with Cable • Screw Type • IP 67 	
			LTWN-455000-MFF000-S001 FEATURES: <ul style="list-style-type: none"> • PowerTap Box • Screw Type • IP 68 	
	LTWMN-05AFFM-SL8CXX FEATURES: <ul style="list-style-type: none"> • Molded with Cable • Screw Type • IP 68 		LTWMN-05AMMM-SL8CXX FEATURES: <ul style="list-style-type: none"> • Molded with Cable • Screw Type • IP 68 	
			LTWMN-000505-0MF-CSCXX FEATURES: <ul style="list-style-type: none"> • Double Conn. with Cable • Screw Type • IP 68 	
			LTWMN-050505-FMF-TS001 FEATURES: <ul style="list-style-type: none"> • T Adaptor • Screw Type • IP 67 	
			LTWMN-050500-FM0-TSXXX FEATURES: <ul style="list-style-type: none"> • T Adaptor, T Cable • Screw Type • IP 68 	
			LTWNC-050505-FMF-TS001 FEATURES: <ul style="list-style-type: none"> • T Adaptor • Screw Type • IP 67 	
			LTWMN-000505-0FM-BS001 FEATURES: <ul style="list-style-type: none"> • Bulkhead • Screw Type • IP 68 	

Please Refer to "How to Order"

Cable Assembly		Mating Parts		Accessories
CONNECTOR	P/N	CONNECTOR	P/N	
	LTWMN-05AFFM-SL8CXX FEATURES: <ul style="list-style-type: none"> • Molded with Cable • Screw Type • IP 68 		LTWMN-000505-0FM-ES001 FEATURES: <ul style="list-style-type: none"> • T Adaptor (90°) • Screw Type • IP 68 	
			LTWNC-000505-0MF-IS001 FEATURES: <ul style="list-style-type: none"> • I Adaptor (Inline Resister) • Screw Type • IP 68 	
			LTWMN-05BMMB-SL7001 FEATURES: <ul style="list-style-type: none"> • Molded with Cable • Screw Type • IP 67 	
	LTWMN-04AFFM-SL8DXX FEATURES: <ul style="list-style-type: none"> • Molded with Cable • Screw Type • IP 68 		LTWN-455000-MFF000-S001 FEATURES: <ul style="list-style-type: none"> • PowerTap Box • Screw Type • IP 68 	

Please Refer to "How to Order"

Cable Assembly		Mating Parts		Accessories
CONNECTOR	P/N	CONNECTOR	P/N	
 <p>LTWMC-000505-OFF-CS△XX</p> <p>FEATURES:</p> <ul style="list-style-type: none"> • Double Conn. with Cable • Screw Type • IP 68 • △ Available in A or B Cable 			LTWMC-05BMMM-SL8△XX FEATURES: <ul style="list-style-type: none"> • Molded with Cable • Screw Type • IP 68 • △ Available in A or B Cable 	
			LTWMC-000505-0MM-CS△XX FEATURES: <ul style="list-style-type: none"> • Double Conn. with Cable • Screw Type • IP 68 • △ Available in A or B Cable 	
			LTWMC-000505-0MF-CS△XX FEATURES: <ul style="list-style-type: none"> • Double Conn. with Cable • Screw Type • IP 68 • △ Available in A or B Cable 	
			LTWSS-050505-△△△-TS001 FEATURES: <ul style="list-style-type: none"> • T Adaptor • Screw Type • △ Available in M, F or B Cable • IP 68 	
			LTWMC-050500-FM0-TSBXX FEATURES: <ul style="list-style-type: none"> • T Adaptor, T Cable • Screw Type • IP 68 	
			LTW12-05BMMB-SL7001 FEATURES: <ul style="list-style-type: none"> • Field Installable • Screw Type • IP 67 	
			LTWMC-05PMMS-SH8001 FEATURES: <ul style="list-style-type: none"> • Panel Mount (Rear) • Screw Type • IP 68 	
			LTWMC-05PMMS-SF8001 FEATURES: <ul style="list-style-type: none"> • Panel Mount (Front) • Screw Type • IP 68 	









Please Refer to "How to Order"

Cable Assembly		Mating Parts		Accessories
CONNECTOR	P/N	CONNECTOR	P/N	
	<p>LTWMC-000505-OFF-CSΔXX</p> <p>FEATURES:</p> <ul style="list-style-type: none"> • Double Conn. with Cable • Screw Type • IP 68 • Δ Available in A or B Cable 		<p>LTWMC-000505-0FM-BS001</p> <p>FEATURES:</p> <ul style="list-style-type: none"> • Bulkhead • Screw Type • IP 68 	
			<p>LTWMC-000505-0FM-ES001</p> <p>FEATURES:</p> <ul style="list-style-type: none"> • T Adaptor (90°) • Screw Type • IP 68 	
			<p>LTWMC-000505-0MF-IS001</p> <p>FEATURES:</p> <ul style="list-style-type: none"> • I Adaptor (Inline Resistor) • Screw Type • IP 68 	
			<p>LTWS-555500-FFFM00-S001</p> <p>FEATURES:</p> <ul style="list-style-type: none"> • T Adaptor (2 Way Tee) • Screw Type • IP 68 	
			<p>LTWS-555555-FFFFFM-S001</p> <p>FEATURES:</p> <ul style="list-style-type: none"> • T Adaptor (4 Way Tee) • Screw Type • IP 68 	
			<p>LTWMC-05BMMT-SL8001</p> <p>FEATURES:</p> <ul style="list-style-type: none"> • Termination Resistor • Screw Type • IP 68 	
			<p>LTWMC-05BMMM-SL8ΔXX</p> <p>FEATURES:</p> <ul style="list-style-type: none"> • Molded with Cable • Screw Type • IP 68 • Δ Available in A or B Cable 	
	<p>LTWMC-000505-0MF-CSΔXX</p> <p>FEATURES:</p> <ul style="list-style-type: none"> • Double Conn. with Cable • Screw Type • IP 68 • Δ Available in A or B Cable 		<p>LTWMC-05BFFM-SL8ΔXX</p> <p>FEATURES:</p> <ul style="list-style-type: none"> • Molded with Cable • Screw Type • IP 68 • Δ Available in A or B Cable 	

Please Refer to "How to Order"

Cable Assembly		Mating Parts		Accessories
CONNECTOR	P/N	CONNECTOR	P/N	
	<p>LTWMC-000505-0MF-CS△XX</p> <p>FEATURES:</p> <ul style="list-style-type: none"> • Double Conn. with Cable • Screw Type • IP 68 • △ Available in A or B Cable 		<p>LTWMC-000505-0MM-CS△XX</p> <p>FEATURES:</p> <ul style="list-style-type: none"> • Double Conn. with Cable • Screw Type • IP 68 • △ Available in A or B Cable 	
			<p>LTWMC-000505-0FF-CS△XX</p> <p>FEATURES:</p> <ul style="list-style-type: none"> • Double Conn. with Cable • Screw Type • IP 68 • △ Available in A or B Cable 	
			<p>LTWMC-000505-0MF-CS△XX</p> <p>FEATURES:</p> <ul style="list-style-type: none"> • Double Conn. with Cable • Screw Type • IP 68 • △ Available in A or B Cable 	
			<p>LTWSS-050505-△△△-TS001</p> <p>FEATURES:</p> <ul style="list-style-type: none"> • T Adaptor • Screw Type • △ Available in M, F, H or B Cable • IP 68 	
			<p>LTWMC-050500-FM0-TSBXX</p> <p>FEATURES:</p> <ul style="list-style-type: none"> • T Adaptor, T Cable • Screw Type • IP 68 	
			<p>LTWMC-050500-MM0-TSBXX</p> <p>FEATURES:</p> <ul style="list-style-type: none"> • T Adaptor, T Cable • Screw Type • IP 68 	
			<p>LTWMC-050500-FF0-TSBXX</p> <p>FEATURES:</p> <ul style="list-style-type: none"> • T Adaptor, T Cable • Screw Type • IP 68 	
			<p>LTW12-05BFFB-SL7001</p> <p>FEATURES:</p> <ul style="list-style-type: none"> • Field Installable • Screw Type • IP 67 	

Please Refer to "How to Order"

Cable Assembly		Mating Parts		Accessories
CONNECTOR	P/N	CONNECTOR	P/N	
 <p>LTWMC-000505-0MF-CS[△]XX</p> <p>FEATURES:</p> <ul style="list-style-type: none"> • Double Conn. with Cable • Screw Type • IP 68 • [△] Available in A or B Cable 		 <p>LTW12-05BMMB-SL7001</p> <p>FEATURES:</p> <ul style="list-style-type: none"> • Field Installable • Screw Type • IP 67 		
		 <p>LTWMC-05PMMS-SH8001</p> <p>FEATURES:</p> <ul style="list-style-type: none"> • Panel Mount (Rear) • Screw Type • IP 68 		
		 <p>LTWMC-05PMMS-SF8001</p> <p>FEATURES:</p> <ul style="list-style-type: none"> • Panel Mount (Front) • Screw Type • IP 68 		
		 <p>LTWMC-05PFFS-SH8001</p> <p>FEATURES:</p> <ul style="list-style-type: none"> • Panel Mount (Rear) • Screw Type • IP 68 		
		 <p>LTWMC-05PFFS-SF8001</p> <p>FEATURES:</p> <ul style="list-style-type: none"> • Panel Mount (Front) • Screw Type • IP 68 		
		 <p>LTWMC-000505-0FM-BS001</p> <p>FEATURES:</p> <ul style="list-style-type: none"> • Bulkhead • Screw Type • IP 68 		
		 <p>LTWMC-000505-0FM-ES001</p> <p>FEATURES:</p> <ul style="list-style-type: none"> • T Adaptor (90°) • Screw Type • IP 68 		
		 <p>LTWMC-000505-0MF-IS001</p> <p>FEATURES:</p> <ul style="list-style-type: none"> • I Adaptor (Inline Resistor) • Screw Type • IP 68 		

Please Refer to "How to Order"

Cable Assembly		Mating Parts		Accessories
CONNECTOR	P/N	CONNECTOR	P/N	
	LTWMC-000505-0MF-CS[△]XX FEATURES: <ul style="list-style-type: none"> • Double Conn. with Cable • Screw Type • IP 68 • [△] Available in A or B Cable 		LTWS-555500-FFFFM00-S001 FEATURES: <ul style="list-style-type: none"> • T Adaptor (2 Way Tee) • Screw Type • IP 68 	
			LTWS-555555-FFFFFM-S001 FEATURES: <ul style="list-style-type: none"> • T Adaptor (4 Way Tee) • Screw Type • IP 68 	
			LTWS-555500-FFFF00-SAXX FEATURES: <ul style="list-style-type: none"> • Extension Cord • Screw Type • IP 68 	
			LTWMC-05BFFT-SL8001 FEATURES: <ul style="list-style-type: none"> • Termination Resistor • Screw Type • IP 68 	
			LTWMC-05BMMT-SL8001 FEATURES: <ul style="list-style-type: none"> • Termination Resistor • Screw Type • IP 68 	
	LTWMC-000505-0MM-CS[△]XX FEATURES: <ul style="list-style-type: none"> • Double Conn. with Cable • Screw Type • IP 68 • [△] Available in A or B Cable 		LTWMC-05BFFM-SL8 [△] XX FEATURES: <ul style="list-style-type: none"> • Molded with Cable • Screw Type • IP 68 • [△] Available in A or B Cable 	
			LTWMC-000505-OFF-CS [△] XX FEATURES: <ul style="list-style-type: none"> • Double Conn. with Cable • Screw Type • IP 68 • [△] Available in A or B Cable 	
			LTWMC-000505-0MF-CS [△] XX FEATURES: <ul style="list-style-type: none"> • Double Conn. with Cable • Screw Type • IP 68 • [△] Available in A or B Cable 	



















Please Refer to "How to Order"

Cable Assembly		Mating Parts		Accessories
CONNECTOR	P/N	CONNECTOR	P/N	
 <p>LTWMC-000505-0MM-CS△XX</p> <p>FEATURES:</p> <ul style="list-style-type: none"> • Double Conn. with Cable • Screw Type • IP 68 • △ Available in A or B Cable 		 <p>LTWSS-050505-△△△-TS001</p> <p>FEATURES:</p> <ul style="list-style-type: none"> • T Adaptor • Screw Type • △ Available in M, F, H or B Cable • IP 68 		
		 <p>LTWMC-050500-FM0-TSBXX</p> <p>FEATURES:</p> <ul style="list-style-type: none"> • T Adaptor, T Cable • Screw Type • IP 68 		
		 <p>LTWMC-050500-FF0-TSBXX</p> <p>FEATURES:</p> <ul style="list-style-type: none"> • T Adaptor, T Cable • Screw Type • IP 68 		
		 <p>LTW12-05BFFB-SL7001</p> <p>FEATURES:</p> <ul style="list-style-type: none"> • Field Installable • Screw Type • IP 67 		
		 <p>LTWMC-05PFFS-SH8001</p> <p>FEATURES:</p> <ul style="list-style-type: none"> • Panel Mount (Rear) • Screw Type • IP 68 		
		 <p>LTWMC-05PFFS-SF8001</p> <p>FEATURES:</p> <ul style="list-style-type: none"> • Panel Mount (Front) • Screw Type • IP 68 		
		 <p>LTWMC-000505-0FM-BS001</p> <p>FEATURES:</p> <ul style="list-style-type: none"> • Bulkhead • Screw Type • IP 68 		
		 <p>LTWMC-000505-0FM-ES001</p> <p>FEATURES:</p> <ul style="list-style-type: none"> • T Adaptor(90°) • Screw Type • IP 68 		

Please Refer to "How to Order"

Cable Assembly		Mating Parts		Accessories
CONNECTOR	P/N	CONNECTOR	P/N	
	LTWMC-000505-0MM-CS^ΔXX FEATURES: <ul style="list-style-type: none"> • Double Conn. with Cable • Screw Type • IP 68 • ^Δ Available in A or B Cable 		LTWMC-000505-0MF-IS001 FEATURES: <ul style="list-style-type: none"> • I Adaptor (Inline Resistor) • Screw Type • IP 68 	
			LTWS-555500-FFFM00-S001 FEATURES: <ul style="list-style-type: none"> • T Adaptor (2 Way Tee) • Screw Type • IP 68 	
			LTWS-555555-FFFFFM-S001 FEATURES: <ul style="list-style-type: none"> • T Adaptor (4 Way Tee) • Screw Type • IP 68 	
			LTWS-555500-FFFF00-SAXX FEATURES: <ul style="list-style-type: none"> • Extension Cord • Screw Type • IP 68 	
			LTWMC-05BFFT-SL8001 FEATURES: <ul style="list-style-type: none"> • Termination Resistor • Screw Type • IP 68 	
			LTWUMC-05BMMM-SL8AXX FEATURES: <ul style="list-style-type: none"> • Molded with Cable • Screw Type • IP 68 	
	LTWUMC-000505-0MF-CSAXX FEATURES: <ul style="list-style-type: none"> • Double Conn. with Cable • Screw Type • IP 68 		LTWUMC-000505-0MF-CSAXX FEATURES: <ul style="list-style-type: none"> • Double Conn. with Cable • Screw Type • IP 68 	
			LTWUMC-050505-FMF-TS001 FEATURES: <ul style="list-style-type: none"> • T Adaptor • Screw Type • IP 68 	

Please Refer to "How to Order"

Cable Assembly		Mating Parts		Accessories
CONNECTOR	P/N	CONNECTOR	P/N	
 	LTWUMC-000505-0MF-CSAXX FEATURES: <ul style="list-style-type: none"> • Double Conn. with Cable • Screw Type • IP 68 	 	LTWUMC-05BFFB-SL7001 FEATURES: <ul style="list-style-type: none"> • Molded with Cable • Screw Type • IP 67 	
		 	LTWUMC-05BMMB-SL7001 FEATURES: <ul style="list-style-type: none"> • Molded with Cable • Screw Type • IP 67 	
		 	LTWUMC-000505-0FM-BS001 FEATURES: <ul style="list-style-type: none"> • Bulkhead • Screw Type • IP 67 	
		 	LTWE-555500-FFFM00-S001 FEATURES: <ul style="list-style-type: none"> • T Adaptor (2 Way Tee) • Screw Type • IP 68 	
		 	LTWE-555555-FFFFM0-S001 FEATURES: <ul style="list-style-type: none"> • T Adaptor (4 Way Tee) • Screw Type • IP 68 	
		 	LTWE-555500-FFFF00-SAXX FEATURES: <ul style="list-style-type: none"> • Extension Cord • Screw Type • IP 68 	
		 	LTWUMC-05BFFT-SL8001 FEATURES: <ul style="list-style-type: none"> • Termination Resistor • Screw Type • IP 68 	
		 	LTWUMC-05BMMT-SL8001 FEATURES: <ul style="list-style-type: none"> • Termination Resistor • Screw Type • IP 68 	

Please Refer to "How to Order"

24 Metal Version: Double Ended Cordset

Cable Assembly		Mating Parts		Accessories
CONNECTOR	P/N	CONNECTOR	P/N	
	LTWUMN-000505-0MF-CSCXX FEATURES: <ul style="list-style-type: none"> • Double Conn. with Cable • Screw Type • IP 68 		LTWUMN-05AMMM-SL8CXX FEATURES: <ul style="list-style-type: none"> • Molded with Cable • Screw Type • IP 68 	
			LTWUMN-000505-0MF-CSCXX FEATURES: <ul style="list-style-type: none"> • Double Conn. with Cable • Screw Type • IP 68 	
			LTWUMN-050505-FMF-TS001 FEATURES: <ul style="list-style-type: none"> • T Adaptor • Screw Type • IP 67 	
			LTWUNC-050505-FMF-TS001 FEATURES: <ul style="list-style-type: none"> • T Adaptor • Screw Type • IP 67 	
			LTWUMN-000505-0FM-BS001 FEATURES: <ul style="list-style-type: none"> • Bulkhead • Screw Type • IP 67 	
			LTWUMN-05BMMB-SL7001 FEATURES: <ul style="list-style-type: none"> • Molded with Cable • Screw Type • IP 67 	
			LTWUMN-05BFFB-SL7001 FEATURES: <ul style="list-style-type: none"> • Molded with Cable • Screw Type • IP 67 	
			LTWU-455000-MFF000-S001 FEATURES: <ul style="list-style-type: none"> • PowerTap Box • Screw Type • IP 68 	

Please Refer to "How to Order"

Cable Assembly		Mating Parts		Accessories
CONNECTOR	P/N	CONNECTOR	P/N	
 	<p>LTWUMN-000505-0MF-CSCXX</p> <p>FEATURES:</p> <ul style="list-style-type: none"> • Double Conn. with Cable • Screw Type • IP 68 	 	<p>LTWUMN-05AFFT-SL8001</p> <p>FEATURES:</p> <ul style="list-style-type: none"> • Termination Resistor • Screw Type • IP 68 	
		 	<p>LTWUMN-05AMMT-SL8001</p> <p>FEATURES:</p> <ul style="list-style-type: none"> • Termination Resistor • Screw Type • IP 68 	
	<p>LTWWMN-000505-0MF-CSCXX</p> <p>FEATURES:</p> <ul style="list-style-type: none"> • Double Conn. with Cable • Screw Type • IP 68 		<p>LTWWMN-05AMMM-SL8CXX</p> <p>FEATURES:</p> <ul style="list-style-type: none"> • Molded with Cable • Screw Type • IP 68 	
			<p>LTWWMN-05AFFM-SL8CXX</p> <p>FEATURES:</p> <ul style="list-style-type: none"> • Molded with Cable • Screw Type • IP 68 	
			<p>LTWWMN-000505-0MF-CSCXX</p> <p>FEATURES:</p> <ul style="list-style-type: none"> • Double Conn. with Cable • Screw Type • IP 68 	
			<p>LTWWMN-050505-FMF-TS001</p> <p>FEATURES:</p> <ul style="list-style-type: none"> • T Adaptor • Screw Type • IP 67 	
			<p>LTWWMN-050500-FM0-TSCXX</p> <p>FEATURES:</p> <ul style="list-style-type: none"> • T Adaptor, T Cable • Screw Type • IP 68 	
			<p>LTWNC-050505-FMF-TS001</p> <p>FEATURES:</p> <ul style="list-style-type: none"> • T Adaptor • Screw Type • IP 67 	







Please Refer to "How to Order"

Cable Assembly		Mating Parts		Accessories
CONNECTOR	P/N	CONNECTOR	P/N	
 <p>LTWMN-000505-0MF-CSCXX</p> <p>FEATURES:</p> <ul style="list-style-type: none"> • Double Conn. with Cable • Screw Type • IP 68 		 <p>LTWMN-000505-0FM-BS001</p> <p>FEATURES:</p> <ul style="list-style-type: none"> • Bulkhead • Screw Type • IP 68 		
		 <p>LTWMN-000505-0FM-ES001</p> <p>FEATURES:</p> <ul style="list-style-type: none"> • T Adaptor (90°) • Screw Type • IP 68 		
		 <p>LTWNC-000505-0MF-IS001</p> <p>FEATURES:</p> <ul style="list-style-type: none"> • I Adaptor (Inline Resistor) • Screw Type • IP 68 		
		 <p>LTWMN-05BMMB-SL7001</p> <p>FEATURES:</p> <ul style="list-style-type: none"> • Molded with Cable • Screw Type • IP 67 		
		 <p>LTWMN-05BFFB-SL7001</p> <p>FEATURES:</p> <ul style="list-style-type: none"> • Molded with Cable • Screw Type • IP 67 		
		 <p>LTWN-455000-MFF000-S001</p> <p>FEATURES:</p> <ul style="list-style-type: none"> • PowerTap Box • Screw Type • IP 68 		
		 <p>LTWMNL-05BFFT-SL8001</p> <p>FEATURES:</p> <ul style="list-style-type: none"> • Termination Resistor • Screw Type • IP 68 		
		 <p>LTWMNL-05BMMT-SL8001</p> <p>FEATURES:</p> <ul style="list-style-type: none"> • Termination Resistor • Screw Type • IP 68 		

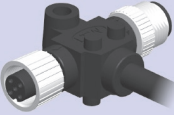
Please Refer to "How to Order"

T Cable Assembly		Mating Parts		Accessories
CONNECTOR	P/N	CONNECTOR	P/N	
	LTWMC-050500-FF0-TSBXX FEATURES: <ul style="list-style-type: none"> • T Adaptor, T Cable • Screw Type • IP 68 		LTWMC-05BMMM-SL8△XX FEATURES: <ul style="list-style-type: none"> • Molded with Cable • Screw Type • IP 68 • △Available in A or B Cable 	
			LTWMC-000505-0MM-CS△XX FEATURES: <ul style="list-style-type: none"> • Double Conn. with Cable • Screw Type • IP 68 • △Available in A or B Cable 	
			LTWMC-000505-0MF-CS△XX FEATURES: <ul style="list-style-type: none"> • Double Conn. with Cable • Screw Type • IP 68 • △Available in A or B Cable 	
			LTWMC-050500-FM0-TSBXX FEATURES: <ul style="list-style-type: none"> • T Adaptor, T Cable • Screw Type • IP 68 	
			LTWMC-050500-MM0-TSBXX FEATURES: <ul style="list-style-type: none"> • T Adaptor, T Cable • Screw Type • IP 68 	
			LTW12-05BMMB-SL7001 FEATURES: <ul style="list-style-type: none"> • Field Installable • Screw Type • IP 67 	
			LTWMC-05BMMT-SL8001 FEATURES: <ul style="list-style-type: none"> • Termination Resister • Screw Type • IP 68 	
	LTWMC-050500-FM0-TSBXX FEATURES: <ul style="list-style-type: none"> • T Adaptor, T Cable • Screw Type • IP 68 		LTWMC-05BMMM-SL8△XX FEATURES: <ul style="list-style-type: none"> • Molded with Cable • Screw Type • IP 68 • △Available in A or B Cable 	

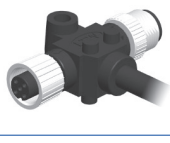
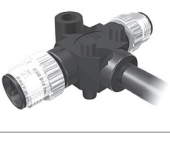
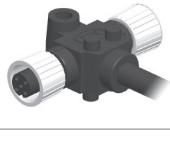
Please Refer to "How to Order"

T Cable Assembly		Mating Parts		Accessories
CONNECTOR	P/N	CONNECTOR	P/N	
	LTWMC-050500-FM0-TSBXX FEATURES: <ul style="list-style-type: none"> • T Adaptor, T Cable • Screw Type • IP 68 		LTWMC-000505-0MM-CS△XX FEATURES: <ul style="list-style-type: none"> • Double Conn. with Cable • Screw Type • IP 68 • △Available in A or B Cable 	
			LTWMC-000505-0FF-CS△XX FEATURES: <ul style="list-style-type: none"> • Double Conn. with Cable • Screw Type • IP 68 • △Available in A or B Cable 	
			LTWMC-000505-0MF-CS△XX FEATURES: <ul style="list-style-type: none"> • Double Conn. with Cable • Screw Type • IP 68 • △Available in A or B Cable 	
			LTWMC-050500-FM0-TSBXX FEATURES: <ul style="list-style-type: none"> • T Adaptor, T Cable • Screw Type • IP 68 	
			LTWMC-050500-MM0-TSBXX FEATURES: <ul style="list-style-type: none"> • T Adaptor, T Cable • Screw Type • IP 68 	
			LTWMC-050500-FF0-TSBXX FEATURES: <ul style="list-style-type: none"> • T Adaptor, T Cable • Screw Type • IP 68 	
			LTW12-05BFFB-SL7001 FEATURES: <ul style="list-style-type: none"> • Field Installable • Screw Type • IP 67 	
			LTW12-05BMMB-SL7001 FEATURES: <ul style="list-style-type: none"> • Field Installable • Screw Type • IP 67 	

Please Refer to "How to Order"

T Cable Assembly		Mating Parts		Accessories
CONNECTOR	P/N	CONNECTOR	P/N	
	LTWMC-050500-FM0-TSBXX FEATURES: <ul style="list-style-type: none"> • T Adaptor, T Cable • Screw Type • IP 68 		LTWS-555500-FFFF00-SBXX FEATURES: <ul style="list-style-type: none"> • Extension Cord • Screw Type • IP 68 	
			LTWMC-05BFFT-SL8001 FEATURES: <ul style="list-style-type: none"> • Termination Resistor • Screw Type • IP 68 	
			LTWMC-05BMMT-SL8001 FEATURES: <ul style="list-style-type: none"> • Termination Resistor • Screw Type • IP 68 	
	LTWMC-050500-MM0-TSBXX FEATURES: <ul style="list-style-type: none"> • T Adaptor, T Cable • Screw Type • IP 68 		LTWMC-05BFFM-SL8△YY FEATURES: <ul style="list-style-type: none"> • Molded with Cable • Screw Type • IP 68 • △ Available in A or B Cable 	
			LTWMC-000505-OFF-CS△XX FEATURES: <ul style="list-style-type: none"> • Double Conn. with Cable • Screw Type • IP 68 • △ Available in A or B Cable 	
			LTWMC-000505-0MF-CS△XX FEATURES: <ul style="list-style-type: none"> • Double Conn. with Cable • Screw Type • IP 68 • △ Available in A or B Cable 	
			LTWMC-050500-FM0-TSBXX FEATURES: <ul style="list-style-type: none"> • T Adaptor, T Cable • Screw Type • IP 68 	
			LTWMC-050500-FF0-TSBXX FEATURES: <ul style="list-style-type: none"> • T Adaptor, T Cable • Screw Type • IP 68 	

Please Refer to "How to Order"

T Cable Assembly		Mating Parts		Accessories
CONNECTOR	P/N	CONNECTOR	P/N	
	LTWMC-050500-MM0-TSBXX FEATURES: <ul style="list-style-type: none"> • T Adaptor, T Cable • Screw Type • IP 68 		LTW12-05BFFB-SL7001 FEATURES: <ul style="list-style-type: none"> • Field Installable • Screw Type • IP 67 	
			LTWS-555500-FFFF00-SBXX FEATURES: <ul style="list-style-type: none"> • Extension Cord • Screw Type • IP 68 	
			LTWMC-05BFFT-SL8001 FEATURES: <ul style="list-style-type: none"> • Termination Resistor • Screw Type • IP 68 	
	 LTWUMC-050500-FM0-TSAXX FEATURES: <ul style="list-style-type: none"> • T Adaptor, T Cable • Screw Type • IP 68 		LTWE-555500-FFFF00-SAXX FEATURES: <ul style="list-style-type: none"> • Extension Cord • Screw Type • IP 68 	
			LTWUMC-05BFFT-SL8001 FEATURES: <ul style="list-style-type: none"> • Termination Resistor • Screw Type • IP 68 	
			LTWUMC-05BMMT-SL8001 FEATURES: <ul style="list-style-type: none"> • Termination Resistor • Screw Type • IP 68 	
	LTWMN-050500-FM0-TSCXX FEATURES: <ul style="list-style-type: none"> • T Adaptor, T Cable • Screw Type • IP 68 		LTWMN-05AMMT-SL8001 FEATURES: <ul style="list-style-type: none"> • Termination Resistor • Screw Type • IP 68 	
			LTWMN-05AFFT-SL8001 FEATURES: <ul style="list-style-type: none"> • Termination Resistor • Screw Type • IP 68 	

Please Refer to "How to Order"

Cable Assembly		Mating Parts		Accessories
CONNECTOR	P/N	CONNECTOR	P/N	
 <p>LTWMN-050500-FM0-TSCXX</p> <p>FEATURES:</p> <ul style="list-style-type: none"> • T Adaptor, T Cable • Screw Type • IP 68 		 <p>LTWMN-05AMMM-SL8CXX</p> <p>FEATURES:</p> <ul style="list-style-type: none"> • Molded with Cable • Screw Type • IP 68 		
		 <p>LTWMN-05AFFM-SL8CXX</p> <p>FEATURES:</p> <ul style="list-style-type: none"> • Molded with Cable • Screw Type • IP 68 		
		 <p>LTWMN-000505-0MF-CSCXX</p> <p>FEATURES:</p> <ul style="list-style-type: none"> • Double Conn. with Cable • Screw Type • IP 68 		
		 <p>LTWMN-050505-FMF-TS001</p> <p>FEATURES:</p> <ul style="list-style-type: none"> • T Adaptor • Screw Type • IP 67 		
		 <p>LTWMN-050500-FM0-TSCXX</p> <p>FEATURES:</p> <ul style="list-style-type: none"> • T Adaptor, T Cable • Screw Type • IP 68 		
		 <p>LTWNC-050505-FMF-TS001</p> <p>FEATURES:</p> <ul style="list-style-type: none"> • T Adaptor • Screw Type • IP 67 		
		 <p>LTWMN-000505-0FM-BS001</p> <p>FEATURES:</p> <ul style="list-style-type: none"> • Bulkhead • Screw Type • IP 68 		
		 <p>LTWMN-000505-0FM-ES001</p> <p>FEATURES:</p> <ul style="list-style-type: none"> • T Adaptor (90°) • Screw Type • IP 68 		

Please Refer to "How to Order"

T Cable Assembly		Mating Parts		Accessories
CONNECTOR	P/N	CONNECTOR	P/N	
	LTWMN-050500-FM0-TSCXX FEATURES: <ul style="list-style-type: none"> • T Adaptor, T Cable • Screw Type • IP 68 		LTWNC-000505-0MF-IS001 FEATURES: <ul style="list-style-type: none"> • I Adaptor (Inline Resistor) • Screw Type • IP 68 	
			LTWMN-05BMMB-SL7001 FEATURES: <ul style="list-style-type: none"> • Molded with Cable • Screw Type • IP 67 	
			LTWMN-05BFFB-SL7001 FEATURES: <ul style="list-style-type: none"> • Molded with Cable • Screw Type • IP 67 	
			LTWN-455000-MFF000-S001 FEATURES: <ul style="list-style-type: none"> • PowerTap Box • Screw Type • IP 68 	
			LTWMNL-05BFFT-SL8001 FEATURES: <ul style="list-style-type: none"> • Termination Resistor • Screw Type • IP 68 	
			LTWMNL-05BMMT-SL8001 FEATURES: <ul style="list-style-type: none"> • Termination Resistor • Screw Type • IP 68 	

Please Refer to "How to Order"

Bulkhead		Mating Parts		Accessories
CONNECTOR	P/N	CONNECTOR	P/N	
 <p>LTWMC-000505-0FM-BS001</p> <p>FEATURES:</p> <ul style="list-style-type: none"> • Bulkhead • Screw Type • IP 68 		 <p>LTWMC-05BMMM-SL8△YY</p> <p>FEATURES:</p> <ul style="list-style-type: none"> • Molded with Cable • Screw Type • IP 68 • △Available in A or B Cable 		
		 <p>LTWMC-05BFFM-SL8△YY</p> <p>FEATURES:</p> <ul style="list-style-type: none"> • Molded with Cable • Screw Type • IP 68 • △Available in A or B Cable 		
		 <p>LTWMC-000505-0FM-BS001</p> <p>FEATURES:</p> <ul style="list-style-type: none"> • Bulkhead • Screw Type • IP 68 		
		 <p>LTWMC-000505-0FF-CS△XX</p> <p>FEATURES:</p> <ul style="list-style-type: none"> • Double Conn. with Cable • Screw Type • IP 68 • △Available in A or B Cable 		
		 <p>LTWMC-000505-0MF-CS△XX</p> <p>FEATURES:</p> <ul style="list-style-type: none"> • Double Conn. with Cable • Screw Type • IP 68 • △Available in A or B Cable 		
		 <p>LTWMC-050500-FF0-TSBXX</p> <p>FEATURES:</p> <ul style="list-style-type: none"> • T Adaptor, T Cable • Screw Type • IP 68 		
		 <p>LTW12-05BFFB-SL7001</p> <p>FEATURES:</p> <ul style="list-style-type: none"> • Field Installable • Screw Type • IP 67 		
		 <p>LTW12-05BMMB-SL7001</p> <p>FEATURES:</p> <ul style="list-style-type: none"> • Field Installable • Screw Type • IP 67 		

Please Refer to "How to Order"

34 Metal Version: Bulkhead

Bulkhead		Mating Parts		Accessories
CONNECTOR	P/N	CONNECTOR	P/N	
	LTWUMC-000505-0FM-BS001 FEATURES: <ul style="list-style-type: none"> • Bulkhead • Screw Type • IP 67 		LTWUMC-05BMMM-SL8AXX FEATURES: <ul style="list-style-type: none"> • Molded with Cable • Screw Type • IP 68 	
			LTWUMC-000505-0MF-CSAXX FEATURES: <ul style="list-style-type: none"> • Double Conn. with Cable • Screw Type • IP 68 	
			LTWUMC-05BFFB-SL7001 FEATURES: <ul style="list-style-type: none"> • Molded with Cable • Screw Type • IP 67 	
			LTWUMC-05BMMB-SL7001 FEATURES: <ul style="list-style-type: none"> • Molded with Cable • Screw Type • IP 67 	
	LTWUMN-000505-0FM-BS001 FEATURES: <ul style="list-style-type: none"> • Bulkhead • Screw Type • IP 67 		LTWUMN-05AMMM-SL8CXX FEATURES: <ul style="list-style-type: none"> • Molded with Cable • Screw Type • IP 68 	
			LTWUMN-000505-0MF-CSCXX FEATURES: <ul style="list-style-type: none"> • Double Conn. with Cable • Screw Type • IP 68 	
			LTWUMN-05BMMB-SL7001 FEATURES: <ul style="list-style-type: none"> • Molded with Cable • Screw Type • IP 67 	
			LTWUMN-05BFFB-SL7001 FEATURES: <ul style="list-style-type: none"> • Molded with Cable • Screw Type • IP 67 	







Please Refer to "How to Order"

Bulkhead		Mating Parts		Accessories
CONNECTOR	P/N	CONNECTOR	P/N	
 <p>LTWMN-000505-0FM-BS001</p> <p>FEATURES:</p> <ul style="list-style-type: none"> • Bulkhead • Screw Type • IP 68 		 <p>LTWMN-05AMMM-SL8CXX</p> <p>FEATURES:</p> <ul style="list-style-type: none"> • Molded with Cable • Screw Type • IP 68 		
		 <p>LTWMN-05AFFM-SL8CXX</p> <p>FEATURES:</p> <ul style="list-style-type: none"> • Molded with Cable • Screw Type • IP 68 		
		 <p>LTWMN-000505-0MF-CSCXX</p> <p>FEATURES:</p> <ul style="list-style-type: none"> • Double Conn. with Cable • Screw Type • IP 68 		
		 <p>LTWMN-050500-FM0-TSCXX</p> <p>FEATURES:</p> <ul style="list-style-type: none"> • T Adaptor, T Cable • Screw Type • IP 68 		
		 <p>LTWMN-05BMMB-SL7001</p> <p>FEATURES:</p> <ul style="list-style-type: none"> • Molded with Cable • Screw Type • IP 67 		
		 <p>LTWMN-05BFFB-SL7001</p> <p>FEATURES:</p> <ul style="list-style-type: none"> • Molded with Cable • Screw Type • IP 67 		

Please Refer to "How to Order"

Cable Assembly		Mating Parts		Accessories
CONNECTOR	P/N	CONNECTOR	P/N	
	LTWMCP-05BFFM-SL8△XX FEATURES: <ul style="list-style-type: none"> • Molded with Cable • Screw Type • IP 68 • △ Available in A or B Cable 		LTWPC-000505-0MM-CS△XX FEATURES: <ul style="list-style-type: none"> • Double Conn. with Cable • Screw Type • IP 68 • △ Available in A or B Cable 	
			LTWPC-000505-0MF-CS△YY FEATURES: <ul style="list-style-type: none"> • Double Conn. with Cable • Screw Type • IP 68 • △ Available in A or B Cable 	
			LTWPC-050500-FM0-TSBXX FEATURES: <ul style="list-style-type: none"> • T Adaptor, T Cable • Screw Type • IP 68 	
			LTWPC-050500-MM0-TSBXX FEATURES: <ul style="list-style-type: none"> • T Adaptor, T Cable • Screw Type • IP 68 	
			LTWPS-050505-△△△-TS001 FEATURES: <ul style="list-style-type: none"> • T Adaptor • Screw Type • △ Available in M, F, H or B Cable • IP 68 	
			LTW12P-05BMMB-SL7001 FEATURES: <ul style="list-style-type: none"> • Field Installable (Screw) • Screw Type • IP 67 	
			LTWMCP-05PMMS-SC8001 FEATURES: <ul style="list-style-type: none"> • Panel Mount (Solder) • Screw Type • IP 68 	
	LTWMCP-05BMMM-SL8△XX FEATURES: <ul style="list-style-type: none"> • Molded with Cable • Screw Type • IP 68 • △ Available in A or B Cable 		LTWMCP-05BFFM-SL8△XX FEATURES: <ul style="list-style-type: none"> • Molded with Cable • Screw Type • IP 68 • △ Available in A or B Cable 	









Please Refer to "How to Order"

Cable Assembly		Mating Parts		Accessories
CONNECTOR	P/N	CONNECTOR	P/N	
 <p>LTMWCP-05BMMM-SL8△XX</p> <p>FEATURES:</p> <ul style="list-style-type: none"> • Molded with Cable • Screw Type • IP 68 • △ Available in A or B Cable 		 <p>LTWPC-000505-OFF-CS△XX</p> <p>FEATURES:</p> <ul style="list-style-type: none"> • Double Conn. with Cable • Screw Type • IP 68 • △ Available in A or B Cable 		
		 <p>LTWPC-000505-0MF-CS△XX</p> <p>FEATURES:</p> <ul style="list-style-type: none"> • Double Conn. with Cable • Screw Type • IP 68 • △ Available in A or B Cable 		
		 <p>LTWPS-050505-△△△-TS001</p> <p>FEATURES:</p> <ul style="list-style-type: none"> • T Adaptor • Screw Type • △ Available in M, F, H or B Cable • IP 68 		
		 <p>LTW12P-05BFFB-SL7001</p> <p>FEATURES:</p> <ul style="list-style-type: none"> • Field Installable (Screw) • Screw Type • IP 68 		
		 <p>LTWPC-050500-FM0-TSBXX</p> <p>FEATURES:</p> <ul style="list-style-type: none"> • T Adaptor, T Cable • Screw Type • IP 68 		
		 <p>LTWPC-050500-FF0-TSBXX</p> <p>FEATURES:</p> <ul style="list-style-type: none"> • T Adaptor, T Cable • Screw Type • IP 68 		

Please Refer to "How to Order"

Cable Assembly		Mating Parts		Accessories
CONNECTOR	P/N	CONNECTOR	P/N	
 <p>LTWPC-000505-OFF-CSΔXX</p> <p>FEATURES:</p> <ul style="list-style-type: none"> • Double Conn. with Cable • Screw Type • IP 68 • Δ Available in A or B Cable 		 <p>LTWMCP-05BMMM-SL8ΔXX</p> <p>FEATURES:</p> <ul style="list-style-type: none"> • Molded with Cable • Screw Type • IP 68 • Δ Available in A or B Cable 		
		 <p>LTWPC-000505-0MM-CSΔXX</p> <p>FEATURES:</p> <ul style="list-style-type: none"> • Double Conn. with Cable • Screw Type • IP 68 • Δ Available in A or B Cable 		
		 <p>LTWPC-000505-0MF-CSΔXX</p> <p>FEATURES:</p> <ul style="list-style-type: none"> • Double Conn. with Cable • Screw Type • IP 68 • Δ Available in A or B Cable 		
		 <p>LTWPS-050505-$\Delta\Delta\Delta$-TS001</p> <p>FEATURES:</p> <ul style="list-style-type: none"> • T Adaptor • Screw Type • Δ Available in M, F, H or B Cable • IP 68 		
		 <p>LTWPC-050500-MM0-TSBXX</p> <p>FEATURES:</p> <ul style="list-style-type: none"> • T Adaptor, T Cable • Screw Type • IP 68 		
		 <p>LTW12P-05BMMB-SL7001</p> <p>FEATURES:</p> <ul style="list-style-type: none"> • Field Installable (Screw) • Screw Type • IP 67 		
		 <p>LTWMCP-05PMMS-SC8001</p> <p>FEATURES:</p> <ul style="list-style-type: none"> • Panel Mount (Solder) • Screw Type • IP 68 		
		 <p>LTWMCP-05BMMT-SL8001</p> <p>FEATURES:</p> <ul style="list-style-type: none"> • Termination Resistor • Screw Type • IP 68 		

Please Refer to "How to Order"

Cable Assembly		Mating Parts		Accessories
CONNECTOR	P/N	CONNECTOR	P/N	
 <p>LTWPC-000505-0MF-CS△XX</p> <p>FEATURES:</p> <ul style="list-style-type: none"> • Double Conn. with Cable • Screw Type • IP 68 • △ Available in A or B Cable 		 <p>LTWMCP-05BMMM-SL8△XX</p> <p>FEATURES:</p> <ul style="list-style-type: none"> • Molded with Cable • Screw Type • IP 68 • △ Available in A or B Cable 		
		 <p>LTWMCP-05BFFM-SL8△XX</p> <p>FEATURES:</p> <ul style="list-style-type: none"> • Molded with Cable • Screw Type • IP 68 • △ Available in A or B Cable 		
		 <p>LTWPC-000505-0MM-CS△XX</p> <p>FEATURES:</p> <ul style="list-style-type: none"> • Double Conn. with Cable • Screw Type • IP 68 • △ Available in A or B Cable 		
		 <p>LTWPC-000505-0FF-CS△XX</p> <p>FEATURES:</p> <ul style="list-style-type: none"> • Double Conn. with Cable • Screw Type • IP 68 • △ Available in A or B Cable 		
		 <p>LTWPC-000505-0MF-CS△XX</p> <p>FEATURES:</p> <ul style="list-style-type: none"> • Double Conn. with Cable • Screw Type • IP 68 • △ Available in A or B Cable 		
		 <p>LTWPS-050505-△△△-TS001</p> <p>FEATURES:</p> <ul style="list-style-type: none"> • T Adaptor • Screw Type • △ Available in M, F, H or B Cable • IP 68 		
		 <p>LTWPC-050500-FM0-TSBXX</p> <p>FEATURES:</p> <ul style="list-style-type: none"> • T Adaptor, T Cable • Screw Type • IP 68 		
		 <p>LTWPC-050500-MM0-TSBXX</p> <p>FEATURES:</p> <ul style="list-style-type: none"> • T Adaptor, T Cable • Screw Type • IP 68 		









Please Refer to "How to Order"

Cable Assembly		Mating Parts		Accessories
CONNECTOR	P/N	CONNECTOR	P/N	
	LTWPC-000505-0MF-CSΔXX FEATURES: <ul style="list-style-type: none"> • Double Conn. with Cable • Screw Type • IP 68 • Δ Available in A or B Cable 		LTWPC-050500-FF0-TSBXX FEATURES: <ul style="list-style-type: none"> • T Adaptor, T Cable • Screw Type • IP 68 	
			LTW12P-05BFFB-SL7001 FEATURES: <ul style="list-style-type: none"> • Field Installable (Screw) • Screw Type • IP 67 	
			LTW12P-05BMFB-SL7001 FEATURES: <ul style="list-style-type: none"> • Field Installable (Screw) • Screw Type • IP 67 	
			LTWMCP-05PMMS-SC8001 FEATURES: <ul style="list-style-type: none"> • Panel Mount (Solder) • Screw Type • IP 68 	
			LTWMCP-05BFFT-SL8001 FEATURES: <ul style="list-style-type: none"> • Termination Resistor • Screw Type • IP 68 	
			LTWMCP-05BMMT-SL8001 FEATURES: <ul style="list-style-type: none"> • Termination Resistor • Screw Type • IP 68 	
			LTWPC-000505-0MM-CSΔXX FEATURES: <ul style="list-style-type: none"> • Double Conn. with Cable • Screw Type • IP 68 • Δ Available in A or B Cable 	
	LTWPC-000505-OFF-CS Δ XX FEATURES: <ul style="list-style-type: none"> • Double Conn. with Cable • Screw Type • IP 68 • Δ Available in A or B Cable 			





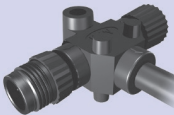

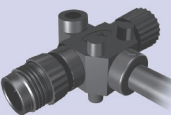

Please Refer to "How to Order"

Cable Assembly		Mating Parts		Accessories
CONNECTOR	P/N	CONNECTOR	P/N	
 <p>LTWPC-000505-0MM-CS△XX</p> <p>FEATURES:</p> <ul style="list-style-type: none"> • Double Conn. with Cable • Screw Type • IP 68 • △ Available in A or B Cable 			<p>LTWPC-000505-0MF-CS△XX</p> <p>FEATURES:</p> <ul style="list-style-type: none"> • Double Conn. with Cable • Screw Type • IP 68 • △ Available in A or B Cable 	
			<p>LTWPS-050505-△△△-TS001</p> <p>FEATURES:</p> <ul style="list-style-type: none"> • T Adaptor • Screw Type • △ Available in M, F, H or B Cable • IP 68 	
			<p>LTW12P-05BFFB-SL7001</p> <p>FEATURES:</p> <ul style="list-style-type: none"> • Field Installable (Screw) • Screw Type • IP 67 	
			<p>LTWPC-000505-0MM-CS△XX</p> <p>FEATURES:</p> <ul style="list-style-type: none"> • Double Conn. with Cable • Screw Type • IP 68 • △ Available in A or B Cable 	
			<p>LTWPC-050500-FM0-TSBXX</p> <p>FEATURES:</p> <ul style="list-style-type: none"> • T Adaptor, T Cable • Screw Type • IP 68 	
			<p>LTWPC-050500-MM0-TSBXX</p> <p>FEATURES:</p> <ul style="list-style-type: none"> • T Adaptor, T Cable • Screw Type • IP 68 	
			<p>LTWPC-050500-FF0-TSBXX</p> <p>FEATURES:</p> <ul style="list-style-type: none"> • T Adaptor, T Cable • Screw Type • IP 68 	
			<p>LTWMCP-05BFFT-SL8001</p> <p>FEATURES:</p> <ul style="list-style-type: none"> • Termination Resistor • Screw Type • IP 68 	







Please Refer to "How to Order"

T Cable Assembly		Mating Parts		Accessories
CONNECTOR	P/N	CONNECTOR	P/N	
	LTWPC-050500-FF0-TSBXX FEATURES: <ul style="list-style-type: none"> • T Adaptor, T Cable • Screw Type • IP 68 		LTWMCP-05BMMM-SL8△XX FEATURES: <ul style="list-style-type: none"> • Molded with Cable • Screw Type • IP 68 • △Available in A or B Cable 	
			LTWPC-000505-0MM-CS△XX FEATURES: <ul style="list-style-type: none"> • Double Conn. with Cable • Screw Type • IP 68 • △Available in A or B Cable 	
			LTWPC-000505-0MF-CS△XX FEATURES: <ul style="list-style-type: none"> • Double Conn. with Cable • Screw Type • IP 68 • △Available in A or B Cable 	
			LTWPC-050500-FM0-TSBXX FEATURES: <ul style="list-style-type: none"> • T Adaptor, T Cable • Screw Type • IP 68 	
			LTWPC-050500-MM0-TSBXX FEATURES: <ul style="list-style-type: none"> • T Adaptor, T Cable • Screw Type • IP 68 	
			LTWMCP-05BMMT-SL8001 FEATURES: <ul style="list-style-type: none"> • Termination Resistor • Screw Type • IP 68 	
	LTWPC-050500-FM0-TSBXX FEATURES: <ul style="list-style-type: none"> • T Adaptor, T Cable • Screw Type • IP 68 		LTWMCP-05BMMM-SL8△XX FEATURES: <ul style="list-style-type: none"> • Molded with Cable • Screw Type • IP 68 • △Available in A or B Cable 	
			LTWMCP-05BFFM-SL8△XX FEATURES: <ul style="list-style-type: none"> • Molded with Cable • Screw Type • IP 68 • △Available in A or B Cable 	

Please Refer to "How to Order"

T Cable Assembly		Mating Parts		Accessories
CONNECTOR	P/N	CONNECTOR	P/N	
 <p>LTWPC-050500-FM0-TSBXX</p> <p>FEATURES:</p> <ul style="list-style-type: none"> • T Adaptor, T Cable • Screw Type • IP 68 		 <p>LTWPC-000505-0MM-CS△XX</p> <p>FEATURES:</p> <ul style="list-style-type: none"> • Double Conn. with Cable • Screw Type • IP 68 • △ Available in A or B Cable 		
		 <p>LTWPC-000505-0MF-CS△XX</p> <p>FEATURES:</p> <ul style="list-style-type: none"> • Double Conn. with Cable • Screw Type • IP 68 • △ Available in A or B Cable 		
		 <p>LTWPC-000505-0MF-CS△XX</p> <p>FEATURES:</p> <ul style="list-style-type: none"> • Double Conn. with Cable • Screw Type • IP 68 • △ Available in A or B Cable 		
		 <p>LTWPC-050500-FM0-TSBXX</p> <p>FEATURES:</p> <ul style="list-style-type: none"> • T Adaptor, T Cable • Screw Type • IP 68 		
		 <p>LTWPC-050500-MM0-TSBXX</p> <p>FEATURES:</p> <ul style="list-style-type: none"> • T Adaptor, T Cable • Screw Type • IP 68 		
		 <p>LTWPC-050500-FF0-TSBXX</p> <p>FEATURES:</p> <ul style="list-style-type: none"> • T Adaptor, T Cable • Screw Type • IP 68 		
		 <p>LTWMCP-05BFFT-SL8001</p> <p>FEATURES:</p> <ul style="list-style-type: none"> • Termination Resistor • Screw Type • IP 68 		
		 <p>LTWMCP-05BMMT-SL8001</p> <p>FEATURES:</p> <ul style="list-style-type: none"> • Termination Resistor • Screw Type • IP 68 		

Please Refer to "How to Order"

T Cable Assembly		Mating Parts		Accessories
CONNECTOR	P/N	CONNECTOR	P/N	
	LTWPC-050500-MM0-TSBXX FEATURES: <ul style="list-style-type: none"> • T Adaptor, T Cable • Screw Type • IP 68 		LTWMCP-05BFFM-SL8△XX FEATURES: <ul style="list-style-type: none"> • Molded with Cable • Screw Type • IP 68 • △Available in A or B Cable 	
			LTWPC-000505-OFF-CS△XX FEATURES: <ul style="list-style-type: none"> • Double Conn. with Cable • Screw Type • IP 68 • △Available in A or B Cable 	
			LTWPC-000505-OMF-CS△XX FEATURES: <ul style="list-style-type: none"> • Double Conn. with Cable • Screw Type • IP 68 • △Available in A or B Cable 	
			LTWPC-050500-FM0-TSBXX FEATURES: <ul style="list-style-type: none"> • T Adaptor, T Cable • Screw Type • IP 68 	
			LTWPC-050500-FF0-TSBXX FEATURES: <ul style="list-style-type: none"> • T Adaptor, T Cable • Screw Type • IP 68 	
			LTWMCP-05BFFT-SL8001 FEATURES: <ul style="list-style-type: none"> • Termination Resister • Screw Type • IP 68 	

Please Refer to "How to Order"

About Amphenol LTW

Founded in 1993 in Taiwan by Peter Chen, LTW Technology is a professional innovator and manufacturer focusing on outdoor waterproof connectors and solutions.

LTW Technology was acquired by Amphenol Group in April of 2010 and now the official name changed from "LTW Technology" to "Amphenol LTW Technology Co., Ltd.". Amphenol LTW is still lead by current management team, under the leadership of Peter Chen and will dedicate to the same principle that LTW has driven relationship with its customers in the past: Quality, Service, Enthusiasm, Professionalism and Innovation.

Amphenol LTW has actively devoted to various outdoor and industrial applications by successfully developing high-end waterproof connectors. We acquired many worldwide patents and certification such as ISO14001, ISO9001, and NMEA 2000...etc. Amphenol LTW is well positioned to enhance products quality and customer service.

Headquartered in Shinjuang city, Taipei County - Taiwan, Amphenol LTW group has approximately 620 employees with R&D center in Hualien, East of Taiwan, Automated CNC, tool and mold factories in Shulin, Taipei County, and a complete production line operating in Kunshan, Jiangshu Province, China.

Products

Amphenol LTW designs and manufactures waterproof connectors which are high/low temperature resistant, UV resistant, and dusts, sands and corrosion proof and cable assemblies for various purposes and applications. All products meet IP66, IP67, IP68 or IP69K. The waterproof range includes Circular, RJ45, D-sub, Sensor, USB, DVI/HDMI, Power Connector, Hybrid Connector, etc.

All products are designed and built to meet high standard requirements such as: Temperature resistant, Fire-proof, Dirt-proof, EMI-proof, Vibration-proof, Shock-proof, UV-resistant, Oil-resistant, Chemical resistant, Environmental-friendly, Durable, Long Life cycle, and Easy of Use.

All products are designed to provide customers value-added solutions whilst enabling to be competitive and shorten time to market cycle.

Applications

Amphenol LTW is more than a supplier of connector but a solution provider to your challenges and problems.

Amphenol LTW connector solutions targeting the following market applications:

- | | | |
|--------------------|-----------------------|------------------------------|
| Aerospace, Medical | Industrial Automation | GPS |
| Military, Marine | Outdoor Surveillance | LED Screen & Lighting |
| Diving Device | Automobile | Renewable Energy |
| Sonar Radar | Audio/Video | WiMax/Wireless Communication |

Amphenol LTW is dedicated to satisfy worldwide customers by innovative design and qualified manufacture for different market segments.

Amphenol® LTW®



Amphenol LTW Technology Co., Ltd.

Head Office (Taiwan):

Amphenol LTW Technology Co., Ltd.

10F, No.657-12, Jungjeng Road, Shinjuang

City, Taipei County 242, Taiwan

Tel: +886-2-2908-5626

Fax: +886-2-2902-9787-88

e-mail: sales@ltw-tech.com

Branch Office (China):

Amphenol Zhengri Electronic (Kunshan) Co., Ltd.

No. 62 Da Tung Road, Peng Lang Street, Kunshan City

Development Zone, Jiangsu Province 215333, China

Tel: +86-512-5761-0501~2

Fax: +86-512-5761-0515

Sales Contact: (East China) +86-512-5761-0512

(South China) +86-755-2823-2407

137-1383-4316

Distributed by :

Amphenol LTW reserves the right to improve, enhance and modify the design specifications and construction of Amphenol LTW products without prior notification. For additional product and technical information, please contact us.

X-ON Electronics

Largest Supplier of Electrical and Electronic Components

Click to view similar products for [Sensor Cables / Actuator Cables](#) category:

Click to view products by [Amphenol](#) manufacturer:

Other Similar products are found below :

[1300070444](#) [43-10984](#) [M83513/19-F01CP](#) [704000D02F120](#) [MDM15SH001K](#) [MDM25PH003BF222](#) [802027107404-1](#) [885030A09M010](#)
[885030A09M020](#) [1200650174](#) [1200651332](#) [1200651713](#) [1200660171](#) [1200660208](#) [1200660343](#) [1200660804](#) [1200660845](#) [1200660926](#)
[1200660977](#) [1200661173](#) [1200661354](#) [120066-1712](#) [1200720053](#) [1200720099](#) [1200720153](#) [1200720172](#) [1200720217](#) [1200720226](#)
[1200720251](#) [1200720285](#) [1200720296](#) [1200720404](#) [1200730148](#) [1200730378](#) [1200800231](#) [1200860112](#) [1200860121](#) [1200860125](#)
[1200860337](#) [1200860365](#) [1200860420](#) [1200870046](#) [1200870123](#) [1200870248](#) [1200980102](#) [1200660181](#) [1200660183](#) [1200660827](#)
[1200660849](#) [1200661170](#)