



SPECIFICATIONS

CUSTOMER

SAMPLE CODE (Ver.)

MASS PRODUCTION CODE (Ver.)



DRAWING NO. (Ver.)

PC1602LRS-FWA-B-Q (Rev.0)

PC-95003

Customer Approved

Date:

Approved	QC Confirmed	Designer
		



Approval For Specifications Only.

* This specification is subject to change without notice.

Please contact Powertip or it's representative before designing your product based on this specification.



Approval For Specifications and Sample.

POWERTIP TECH. CORP.

Headquarters:

No.8, 6th Road, Taichung Industrial Park,

Taichung, Taiwan

台中市 407 工業區六路 8 號

TEL: 886-4-2355-8168

FAX: 886-4-2355-8166

E-mail: sales@powertip.com.tw

Http://www.powertip.com.tw

RECORDS OF REVISION

Date	Rev.	Description	Note	Page
2005/10/28	0	PC1602LRS-FWA-B-Q is the ROHS compliant part number based on Powertip's standard PC1602LRS-FWA-B		

Total : 23 Page

Contents

1. SPECIFICATIONS

- 1.1 Features**
- 1.2 Mechanical Specifications**
- 1.3 Absolute Maximum Ratings**
- 1.4 DC Electrical Characteristics**
- 1.5 Optical Characteristics**
- 1.6 Backlight Characteristics**

2. MODULE STRUCTURE

- 2.1 Counter Drawing**
- 2.2 Interface Pin Description**
- 2.3 Timing Characteristics**
- 2.4 Display Command**
- 2.5 Character Pattern**

3. QUALITY ASSURANCE SYSTEM

- 3.1 Quality Assurance Flow Chart**
- 3.2 Inspection Specification**

4. RELIABILITY TEST

- 4.1 Reliability Test Condition**

5. PRECAUTION RELATING PRODUCT HANDLING

- 5.1 Safety**
- 5.2 Handling**
- 5.3 Storage**
- 5.4 Terms of Warranty**

Note : For detailed information please refer to IC data sheet : [ST7066U,KS0065B](#)

1. SPECIFICATIONS

1.1 Features

Item	Standard Value
Display Type	16*2 Characters
LCD Type	STN Gray Positive Transflective Normal Temp.
Driver Condition	LCD Module : 1/16 Duty , 1/5 Bias
Viewing Direction	6 O'clock
Backlight	YG LED B/L
Weight	36 g
Interface	—
ROHS	THIS PRODUCT CONFORMS THE ROHS OF PTC Detail information please refer web side : http://www.powertip.com.tw/news/LatestNews.asp

1.2 Mechanical Specifications

Item	Standard Value	Unit
Outline Dimension	84.0(L) * 44.0(w) * 13.7(H)(Max)	mm
Viewing Area	61.0(L) * 15.8(w)	mm
Active Area	56.21(L) * 11.5(w)	mm
Dot Size	0.56(L) * 0.66(w)	mm
Dot Pitch	0.60 (L) * 0.70(w)	mm

Note : For detailed information please refer to LCM drawing

1.3 Absolute Maximum Ratings

Item	Symbol	Condition	Min.	Max.	Unit
Power Supply Voltage	V _{DD}	—	-0.3	7.0	V
LCD Driver Supply Voltage	V _{LCD}	—	V _{DD} -10.0	V _{DD} +0.3	V
Input Voltage	V _{IN}	—	-0.3	V _{DD} +0.3	V
Operating Temperature	T _{OP}	Excluded B/L	0	50	°C
Storage Temperature	T _{ST}	Excluded B/L	-20	70	°C
Storage Humidity	H _D	T _a < 40 °C	-	90	%RH

1.4 DC Electrical Characteristics

$V_{DD} = 5.0 \text{ V} \pm 0.5 \text{ V}$, $V_{SS} = 0 \text{ V}$, $T_a = 25^\circ \text{C}$

Item	Symbol	Condition	Min.	Typ.	Max.	Unit
Logic Supply Voltage	V_{DD}	—	4.5	5.0	5.5	V
“H” Input Voltage	V_{IH}	—	$0.7 V_{DD}$	-	V_{DD}	V
“L” Input Voltage	V_{IL}	—	-0.3	-	0.6	V
“H” Output Voltage	V_{OH}	$I_{OH} = -0.1 \text{ mA}$	3.9	-	V_{DD}	V
“L” Output Voltage	V_{OL}	$I_{OL} = 0.1 \text{ mA}$	-	-	0.4	V
Supply Current	I_{DD}	$V_{DD} = 5.0 \text{ V}$	-	1.5	3.0	mA
LCM Driver Voltage	V_{OP}	0°C	-	-	-	V
		25°C *1	4.3	4.5	4.7	
		50°C	-	-	-	

Note: *1. THE V_{OP} TEST POINT IS $V_{DD} - V_O$.

1.5 Optical Characteristics

LCD Panel : 1/16 Duty , 1/4 Bias , $V_{LCD} = 4.2 \text{ V}$, $T_a = 25^\circ \text{C}$

Item	Symbol	Conditions	Min.	Typ.	Max.	Reference
View Angle	θ	$C \geq 2.0$, $\varnothing = 0^\circ$	40°	-	-	Notes 1 & 2
Contrast Ratio	C	$\theta = 5^\circ$, $\varnothing = 0^\circ$	5	7	-	Note 3
Response Time(rise)	t_r	$\theta = 5^\circ$, $\varnothing = 0^\circ$	-	150 ms	-	Note 4
Response Time(fall)	t_f	$\theta = 5^\circ$, $\varnothing = 0^\circ$	-	300 ms	-	Note 4

Note 1: Definition of angles θ and \varnothing

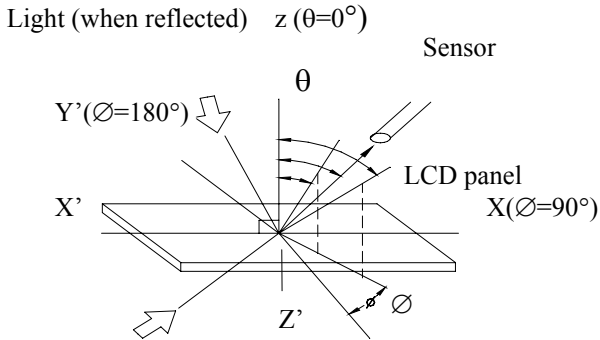

Light (when transmitted) $Y (\varnothing=0^\circ)$
 $(\theta=90^\circ)$

Note 2: Definition of viewing angles θ_1 and θ_2

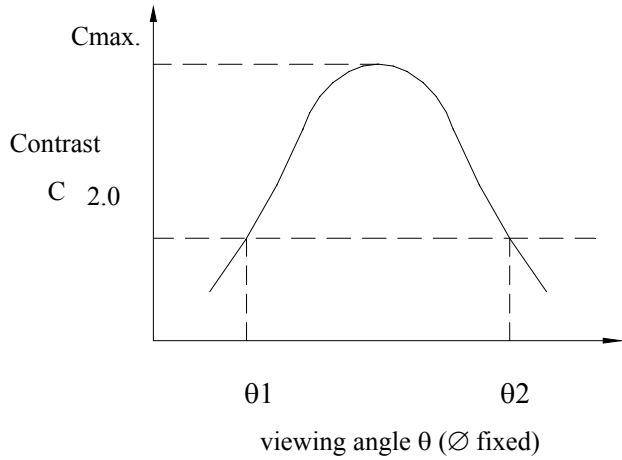

Note : Optimum viewing angle with the naked eye and viewing angle θ at C_{max} . Above are not always the same

Note 3: Definition of contrast C

$$C = \frac{\text{Brightness (reflection) of unselected dot (B2)}}{\text{Brightness (reflection) of selected dot (B1)}}$$

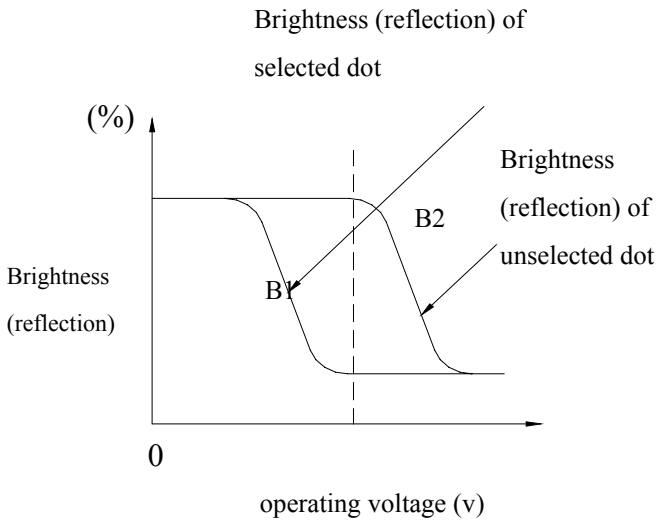

Note 4: Definition of response time

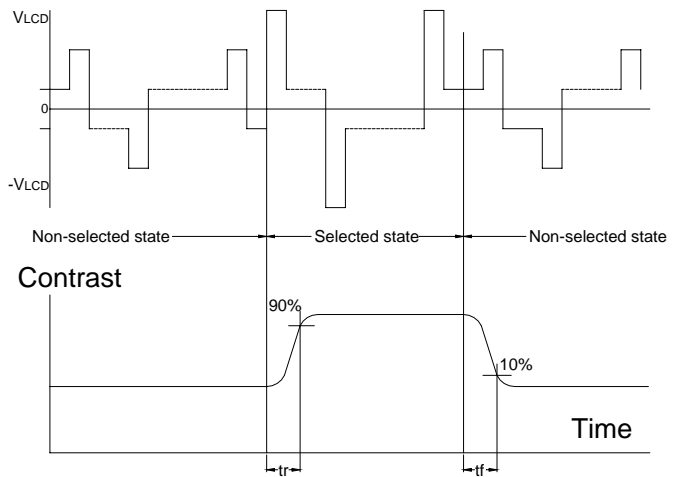

Note: Measured with a transmissive LCD panel which is displayed 1 cm^2

V_{LCD} : Operating voltage f_{FRM} : Frame frequency
 t_r : Response time (rise) t_f : Response time (fall)

1.6 Backlight Characteristics

LCD Module with LED Backlight

Maximum Ratings

Item	Symbol	Conditions	Min.	Max.	Unit
Forward Current	IF	Ta =25°C	-	300	mA
Reverse Voltage	VR	Ta =25°C	-	8	V
Power Dissipation	PO	Ta =25°C	-	1.38	W

Electrical / Optical Characteristics

Ta =25°C						
Item	Symbol	Conditions	Min.	Typ.	Max.	Unit
Forward Voltage	VF	IF= 120 mA	-	4.2	4.6	V
Reverse Current	IR	VR= 8 V	-	-	0.2	mA
Wavelength	λp	IF= 120 mA	571	-	576	nm
Luminous Intensity (without LCD)	IV	IF=120 mA	160	210	250	cd/m ²
Color	Yellow-green					

2. MODULE STRUCTURE

2.1 Counter Drawing

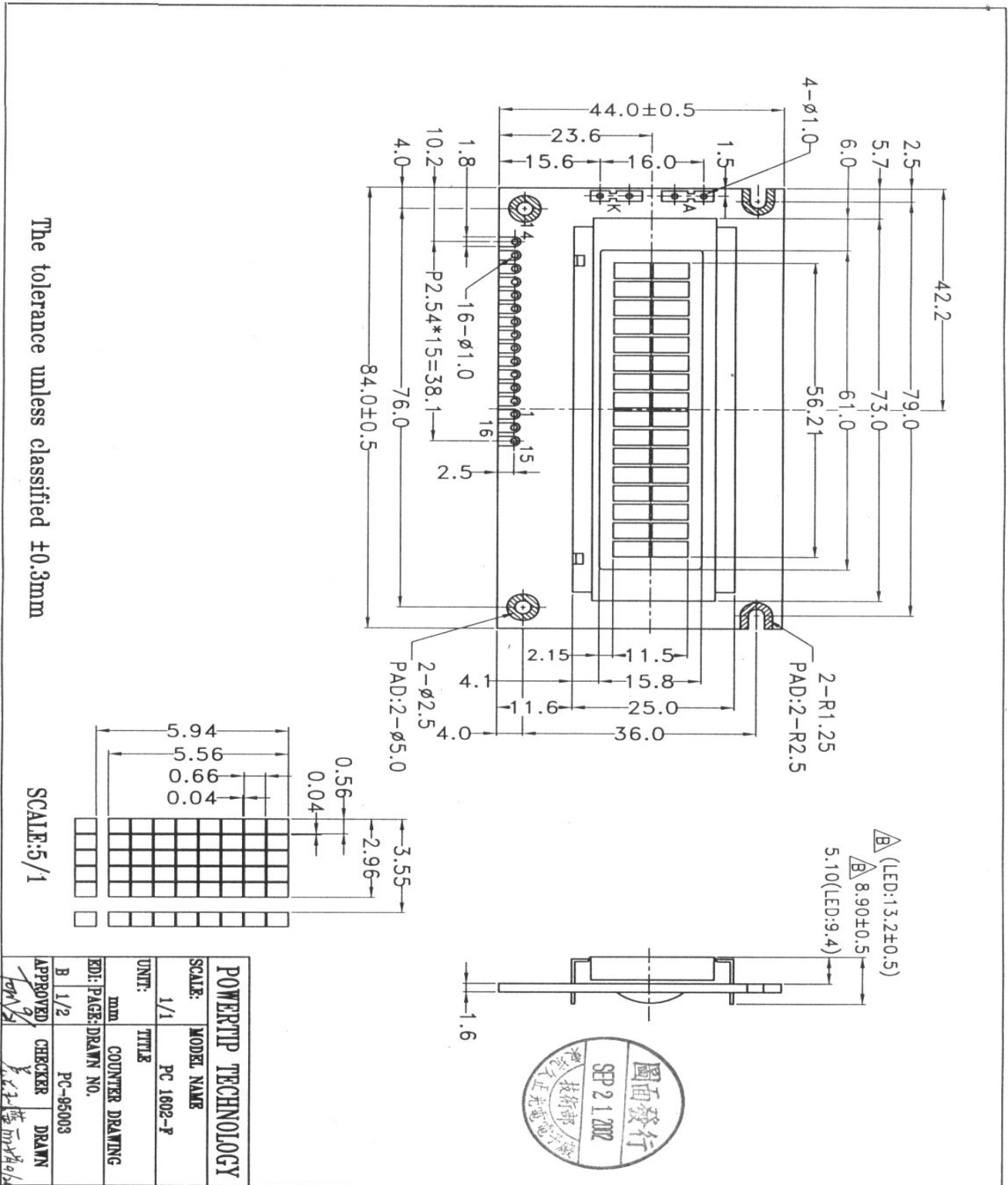



POWERTIP

PIN NO.	SIGNAL
1	Vss
2	Vdd
3	Vo
4	RS
5	R/W
6	E
7	DB0
8	DB1
9	DB2
10	DB3
11	DB4
12	DB5
13	DB6
14	DB7
15	A
16	K

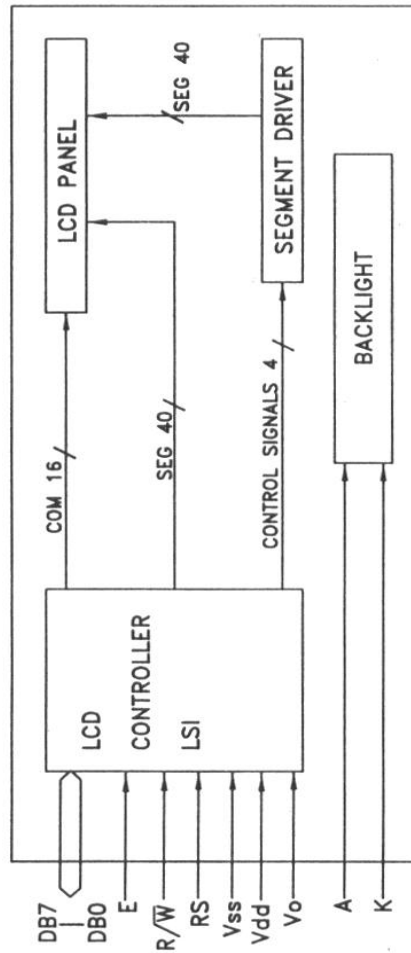

POWERTIP TECHNOLOGY	
SCALE:	MODEL NAME
NO SCALE	PC 1602-F
UNIT:	TITLE
NO UNIT	COUNTER DRAWING
EDI: PAGE:	DRAWN NO.
B 2/2	PC-95003
APPROVED	CHECKER
9/2002	DRAWN

2002
9/20
樹上線電

2.2 Interface Pin Description

Pin No.	Symbol	Signal Description
1	V _{SS}	Power Supply (V _{SS} =0)
2	V _{DD}	Power Supply (V _{DD} >V _{SS})
3	V _O	Operating voltage for LCD
4	RS	Register Selection input High = Data register Low = Instruction register (for write) Busy flag address counter (for read)
5	$\overline{\text{R/W}}$	Read/Write signal input is used to select the read/write mode High = Read mode, Low = Write mode
6	E	Start enable signal to read or write the data
7~10	DB0 ~ DB3	Four low order bi-directional three-state data bus lines. Use for data transfer between the MPU and the LCD module. These four are not used during 4-bit operation.
11~14	DB4~DB7	Four high order bi-directional three-state data bus lines. Used for data transfer between the MPU and the LCD module. DB7 can be used as a busy flag.
15	A	Power supply for LED B/L (+)
16	K	Power supply for LED B/L (-)

Contrast Adjust

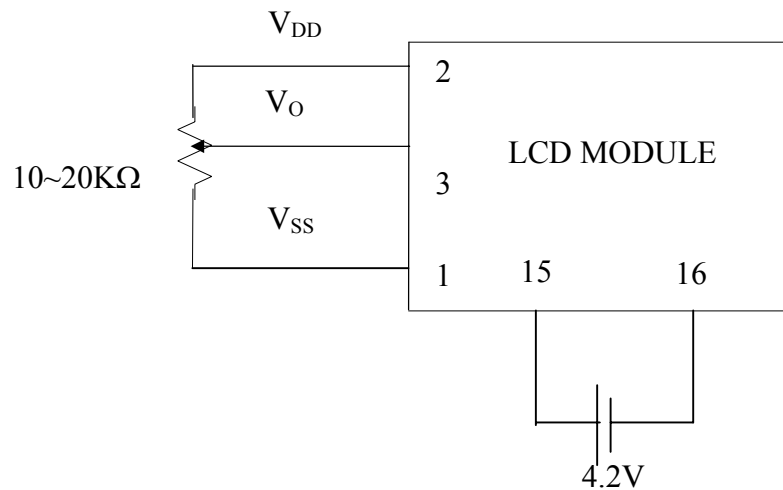

2.3 Timing Characteristics

- Writing data from MPU to ST7066U

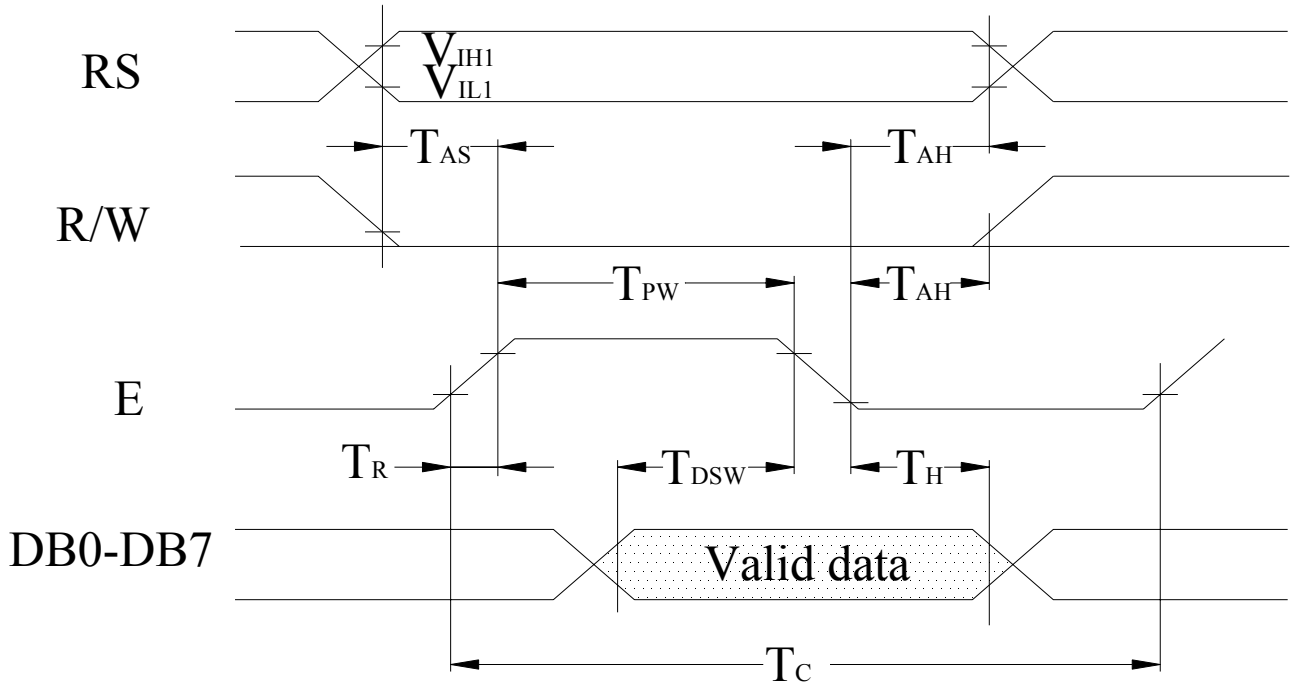

- Reading data from ST7066U to MPU

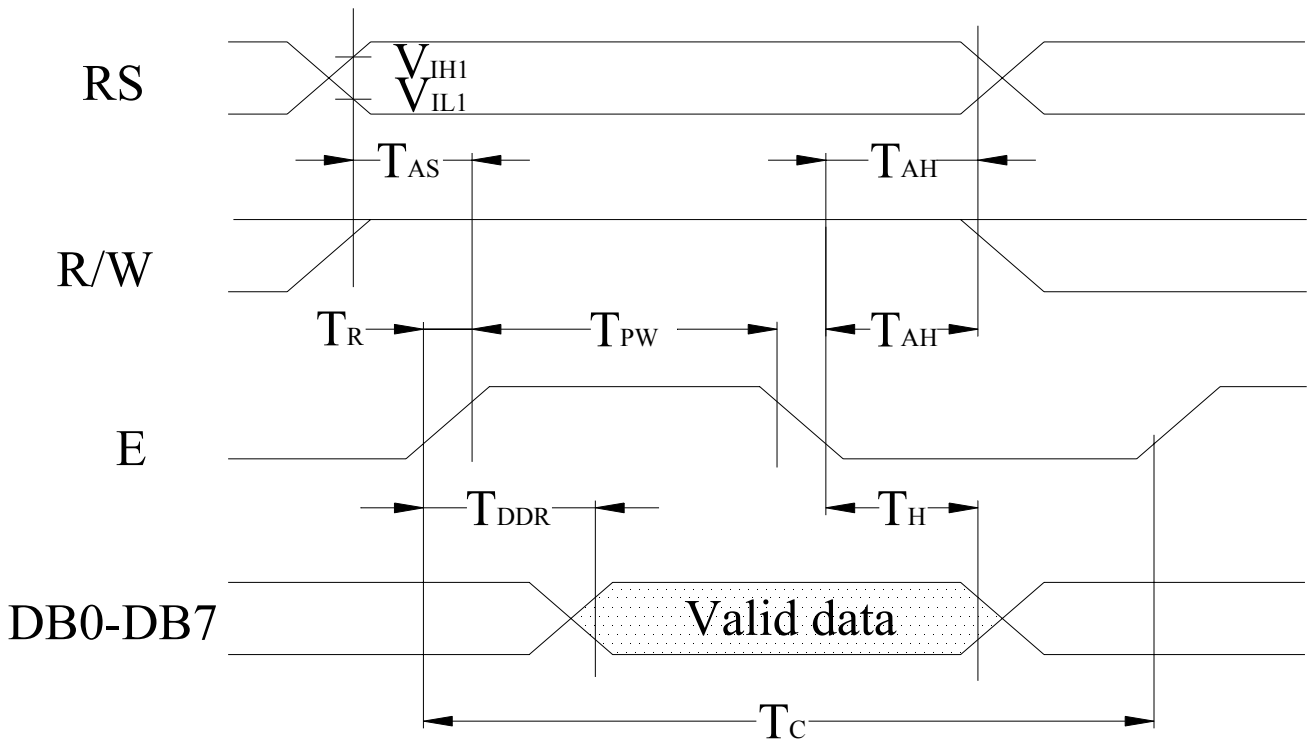

- Write Mode (Writing data from MPU to ST7066U)

(V_{cc} = +5V, Ta=25°C)

Symbol	Characteristics	Test Condition	Min.	Typ.	Max.	Unit
T _C	Enable Cycle Time	Pin E	1200	-	-	ns
T _{PW}	Enable Pulse Width	Pin E	140	-	-	ns
T _R , T _F	Enable Rise / Fall Time	Pin E	-	-	25	ns
T _{AS}	Address Setup Time	Pins: RS , RW,E	0	-	-	ns
T _{AH}	Address Hold Time	Pins :RS,RW,E	10	-	-	ns
T _{DSW}	Data Setup Time	Pins:DB0~DB7	40	-	-	ns
T _H	Data Hold Time	Pins:DB0~DB7	10	-	-	ns

- Read Mode (Reading data from ST7066U to MPU)

(V_{cc} = +5V, Ta=25°C)

Symbol	Characteristics	Test Condition	Min.	Typ.	Max.	Unit
T _C	Enable Cycle Time	Pin E	1200	-	-	ns
T _{PW}	Enable Pulse Width	Pin E	140	-	-	ns
T _R , T _F	Enable Rise / Fall Time	Pin E	-	-	25	ns
T _{AS}	Address Setup Time	Pins: RS , RW,E	0	-	-	ns
T _{AH}	Address Hold Time	Pins :RS,RW,E	10	-	-	ns
T _{DDR}	Data Setup Time	Pins:DB0~DB7	-	-	100	ns
T _H	Data Hold Time	Pins:DB0~DB7	10	-	-	ns

2.4 Display Command

Instructions	Instruction Code										Description	Description Time (270KHz)	
	RS	R/W	DB 7	DB 6	DB 5	DB 4	DB 3	DB 2	DB 1	DB 0			
Clear Display	0	0	0	0	0	0	0	0	0	0	1	Write "20H" to DDRAM. and set DDRAM address to "00H" from AC.	1.52ms
Return Home	0	0	0	0	0	0	0	0	0	1	×	Set DDRAM address to "00H" from AC and return cursor to it's original position if shifted. The contents of DDRAM are not changed.	1.52ms
Entry Mode Set	0	0	0	0	0	0	0	0	1	I/D	S	Sets cursor move direction and specifies display shift. These operations are performed during data write and read .	37μs
Display ON/OFF	0	0	0	0	0	0	0	1	D	C	B	D=1 : entire display on C=1 : cursor on B=1 : cursor position on	37μs
Cursor or Display Shift	0	0	0	0	0	0	1	S/C	R/L	×	×	Set cursor moving and display shift control bit, and the direction, without changing of DDRAM data.	37μs
Function Set	0	0	0	0	0	1	DL	N	F	×	×	DL: interface data is 8/4 bits NL: number of line is 2/1 F: font size is 5×11/5×8	37μs
Set CGRAM Address	0	0	0	1	AC 5	AC 4	AC 3	AC 2	AC 1	AC 0		Set CGRAM address in address counter.	37μs
Set DDRAM Address	0	0	1	AC 6	AC 5	AC 4	AC 3	AC 2	AC 1	AC 0		Set DDRAM address in address counter.	37μs

Read Busy Flag and Address	0	1	BF	AC 6	AC 5	AC 4	AC 3	AC 2	AC 1	AC 0	Whether during internal operation or not can be known by reading BF. The contents of address counter can also be read.	0 μ s
Write Data to RAM	1	0	D7	D6	D5	D4	D3	D2	D1	D0	Write data into internal RAM (DDRAM/CGRAM).	37 μ s
Read Data from RAM	1	1	D7	D6	D5	D4	D3	D2	D1	D0	Read data from internal RAM (DDRAM/CGRAM).	37 μ s

Note:

Be sure the ST7066U is not in the busy state (BF=0) before sending an instruction from the MPU to the ST7066.

If an instruction is sent without checking the busy flag , the time between the first instruction and next instruction will take much longer than the instruction time itself.

Refer to Instruction Table for the list of each instruction execution time .



2.5 Character Pattern

CHARACTER PATTERN(SO/HO/EA,WA)

Upper 4 Bits Lower 4 Bits	0000	0001	0010	0011	0100	0101	0110	0111	1000	1001	1010	1011	1100	1101	1110	1111
xxxx0000	CG RAM (1)			Q	A	P	\	P				—	9	E	O	P
xxxx0001	(2)		!	1	A	a	a				a	7	+	+	+	9
xxxx0010	(3)		"	2	B	R	b	r			r	4	u	x	p	e
xxxx0011	(4)		#	3	C	S	c	s			j	9	t	e	e	s
xxxx0100	(5)		*	4	D	T	d	t			\	E	T	T	N	S
xxxx0101	(6)		%	5	E	U	e	u			.	*	*	+	+	0
xxxx0110	(7)		&	6	F	V	f	v			7	+	+	+	+	+
xxxx0111	(8)		'	7	G	W	g	w			7	+	+	+	+	+
xxxx1000	(1)		(8	H	X	h	x			4	0	+	+	+	+
xxxx1001	(2))	9	I	Y	i	y			9	7	+	+	+	+
xxxx1010	(3)		*	:	J	Z	j	z			+	0	+	+	+	+
xxxx1011	(4)		+	:	K	C	k	c			+	+	+	+	+	+
xxxx1100	(5)		.	<	L	*	l	*			+	9	+	+	+	+
xxxx1101	(6)		—	=	M	I	m	i			+	+	+	+	+	+
xxxx1110	(7)		.	>	N	^	n	^			+	+	+	+	+	+
xxxx1111	(8)		/	?	O	_	o	_			+	+	+	+	+	+

3. QUALITY ASSURANCE SYSTEM

3.1 Quality Assurance Flow Chart

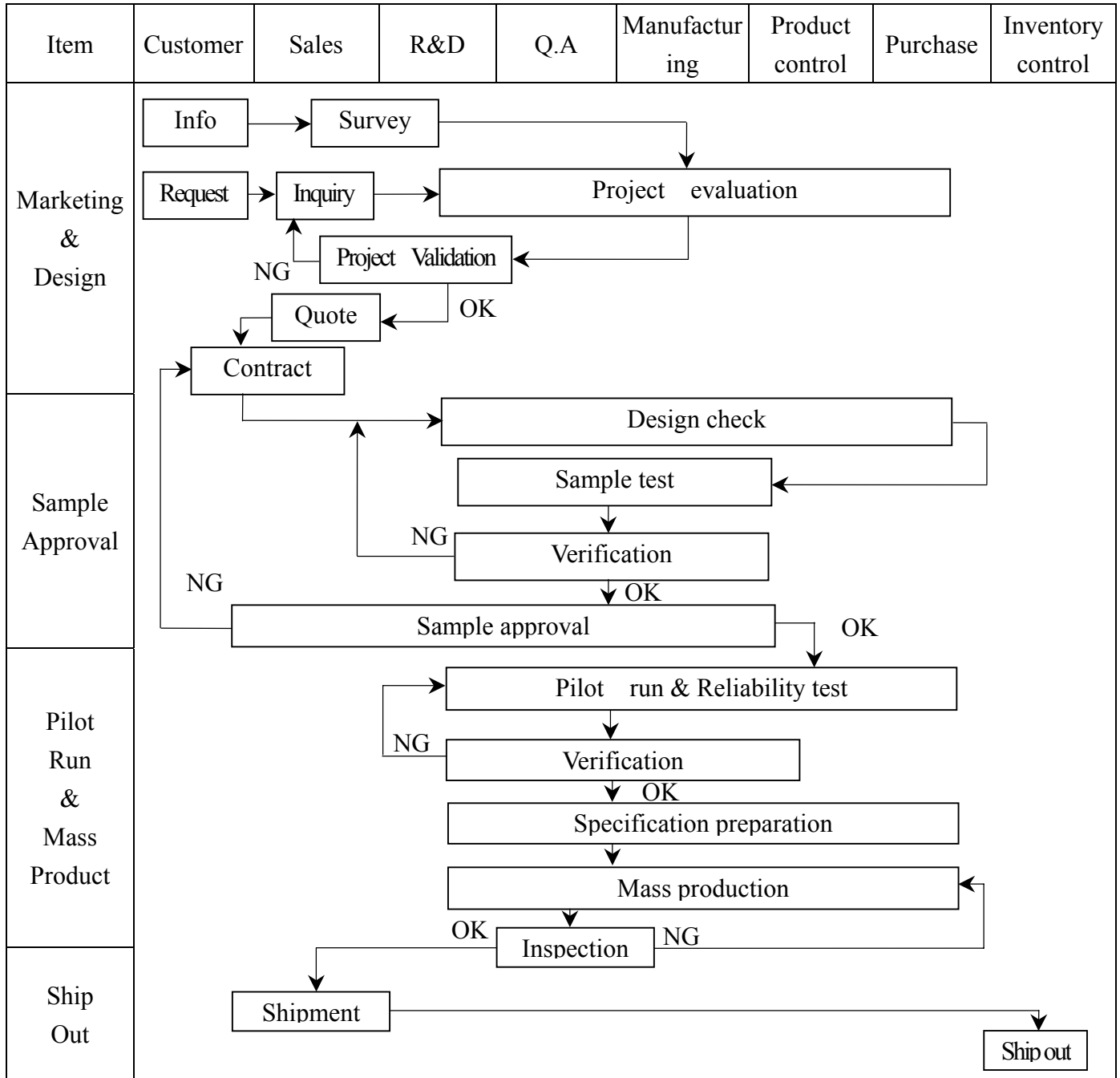

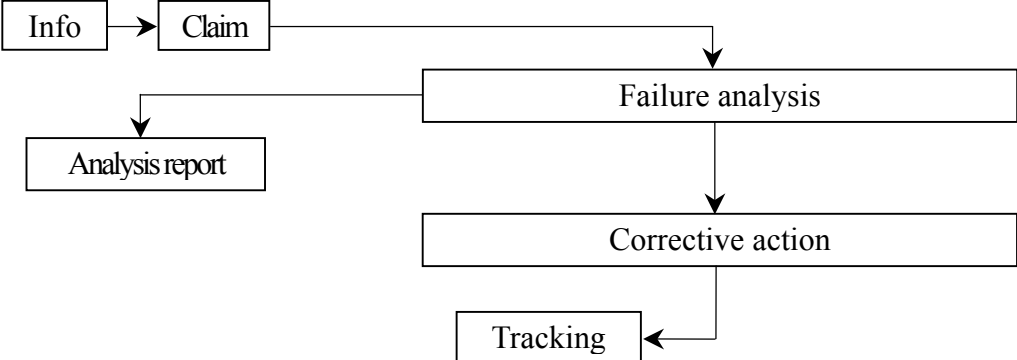
Item	Customer	Sales	R&D	Q.A	Manufacturing	Product control	Purchase	Inventory control
Sales Service	 <pre> graph TD Info[Info] --> Claim[Claim] Claim --> Failure[Failure analysis] Failure --> Report[Analysis report] Failure --> Action[Corrective action] Action --> Tracking[Tracking] </pre>							
Q.A Activity	1. ISO 9001 Maintenance Activities 3. Equipment calibration 5. Standardization Management				2. Process improvement proposal 4. Education And Training Activities			

3.2 Inspection Specification

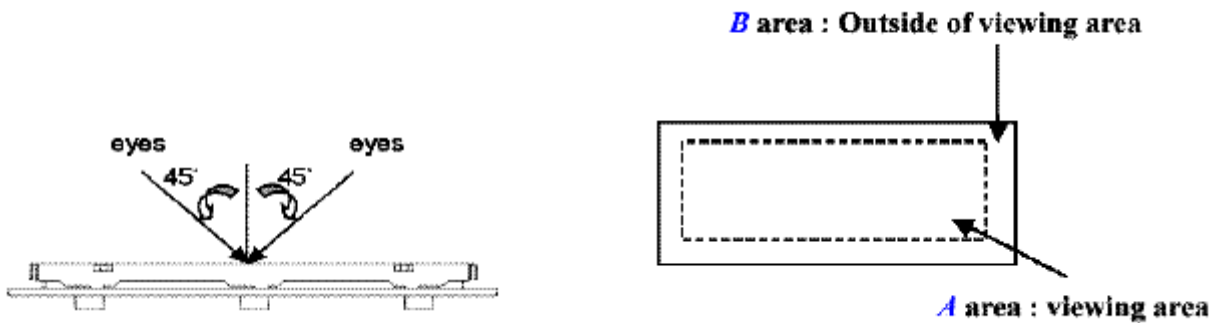

- ◆ Inspection Standard : MIL-STD-105E Table Normal Inspection Single Sampling Level II .
- ◆ Equipment : Gauge 、 MIL-STD 、 Powertip Tester 、 Sample
- ◆ Defect Level : Major Defect AQL 0.4; Minor Defect AQL 1.5 .
- ◆ OUT Going Defect Level : Sampling .
- ◆ Manner of appearance test :
 - (1). The test be under 40W×2 fluorescent light ' and distance of view must be at 30 cm.
 - (2). The test direction is base on about around 45° of vertical line. (Fig. 1)
 - (3). Definition of area . (Fig. 2)



◆ Specification:

NO	Item	Criterion	level
01	Product condition	1.1 The part number is inconsistent with work order of Production.	Major
		1.2 Mixed production types.	Major
		1.3 Assembled in inverse direction.	Major
02	Quantity	2.1 The quantity is inconsistent with work order of production.	Major
03	Outline dimension	3.1 Product dimension and structure must conform to Structure diagram.	Major
04	Electrical Testing	4.1 Missing line character 、 dot and icon.	Major
		4.2 No function or no display.	Major
		4.3 Output data is error.	Major
		4.4 LCD viewing angle defect.	Major
		4.5 Current consumption exceeds product specifications.	Major
05	Black or white dot 、 scratch 、 contamination Round type	5.1 Round type: 5.1.1 display only : <ul style="list-style-type: none"> • White and black spots on display $\leq 0.25\text{mm}$, no more than Four white or black spots present. • Densely spaced : NO more than two spots or lines within 3mm 	Minor

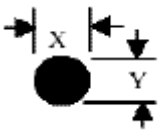
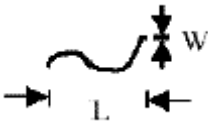
◆ Specification :

NO	Item	Criterion	level																																	
05	Black or white dot、scratch、contamination Round type  $\Phi = (x+y)/2$ 	5.1.2 Nom-display : <table border="1" data-bbox="518 459 1340 683"> <thead> <tr> <th>Dimension (diameter : Φ)</th> <th>Acceptance(Q'ty)</th> </tr> </thead> <tbody> <tr> <td>$\Phi \leq 0.10\text{mm}$</td> <td>Accept no dense</td> </tr> <tr> <td>$0.10\text{mm} < \Phi \leq 0.20\text{mm}$</td> <td>3</td> </tr> <tr> <td>$0.20\text{mm} < \Phi \leq 0.25\text{mm}$</td> <td>2</td> </tr> <tr> <td>Total</td> <td>4</td> </tr> </tbody> </table> 5.1.3 Line type: <table border="1" data-bbox="422 750 1412 1008"> <thead> <tr> <th colspan="2">Dimension (diameter : Φ)</th> <th colspan="2">Acceptance (Q'ty)</th> </tr> <tr> <th>Length</th> <th>width</th> <th>A area</th> <th>B area</th> </tr> </thead> <tbody> <tr> <td>---</td> <td>$w \leq 0.03\text{mm}$</td> <td>Accept no dense</td> <td>Don't count</td> </tr> <tr> <td>$L \leq 3.0\text{mm}$</td> <td>$0.03\text{mm} < \Phi \leq 0.05\text{mm}$</td> <td rowspan="2">4</td> <td>Don't count</td> </tr> <tr> <td>$L \leq 2.5\text{mm}$</td> <td>$0.05\text{mm} < \Phi \leq 0.075\text{mm}$</td> <td>Don't count</td> </tr> <tr> <td>---</td> <td>$w > 0.075\text{mm}$</td> <td colspan="2">As round type</td> </tr> </tbody> </table>	Dimension (diameter : Φ)	Acceptance(Q'ty)	$\Phi \leq 0.10\text{mm}$	Accept no dense	$0.10\text{mm} < \Phi \leq 0.20\text{mm}$	3	$0.20\text{mm} < \Phi \leq 0.25\text{mm}$	2	Total	4	Dimension (diameter : Φ)		Acceptance (Q'ty)		Length	width	A area	B area	---	$w \leq 0.03\text{mm}$	Accept no dense	Don't count	$L \leq 3.0\text{mm}$	$0.03\text{mm} < \Phi \leq 0.05\text{mm}$	4	Don't count	$L \leq 2.5\text{mm}$	$0.05\text{mm} < \Phi \leq 0.075\text{mm}$	Don't count	---	$w > 0.075\text{mm}$	As round type		Minor
Dimension (diameter : Φ)	Acceptance(Q'ty)																																			
$\Phi \leq 0.10\text{mm}$	Accept no dense																																			
$0.10\text{mm} < \Phi \leq 0.20\text{mm}$	3																																			
$0.20\text{mm} < \Phi \leq 0.25\text{mm}$	2																																			
Total	4																																			
Dimension (diameter : Φ)		Acceptance (Q'ty)																																		
Length	width	A area	B area																																	
---	$w \leq 0.03\text{mm}$	Accept no dense	Don't count																																	
$L \leq 3.0\text{mm}$	$0.03\text{mm} < \Phi \leq 0.05\text{mm}$	4	Don't count																																	
$L \leq 2.5\text{mm}$	$0.05\text{mm} < \Phi \leq 0.075\text{mm}$		Don't count																																	
---	$w > 0.075\text{mm}$	As round type																																		
06	Polarizer Bubble	<table border="1" data-bbox="422 1086 1396 1422"> <thead> <tr> <th rowspan="2">Dimension (diameter : Φ)</th> <th colspan="2">Acceptance(Q'ty)</th> </tr> <tr> <th>A area</th> <th>B area</th> </tr> </thead> <tbody> <tr> <td>$\Phi \leq 0.20\text{mm}$</td> <td>Accept no dense</td> <td>Don't count</td> </tr> <tr> <td>$0.20\text{mm} < \Phi \leq 0.50\text{mm}$</td> <td>3</td> <td>Don't count</td> </tr> <tr> <td>$0.50\text{mm} < \Phi \leq 1.00\text{mm}$</td> <td>2</td> <td>Don't count</td> </tr> <tr> <td>$\Phi > 1.00\text{mm}$</td> <td>0</td> <td>Don't count</td> </tr> <tr> <td>Total quantity</td> <td>4</td> <td>Don't count</td> </tr> </tbody> </table>	Dimension (diameter : Φ)	Acceptance(Q'ty)		A area	B area	$\Phi \leq 0.20\text{mm}$	Accept no dense	Don't count	$0.20\text{mm} < \Phi \leq 0.50\text{mm}$	3	Don't count	$0.50\text{mm} < \Phi \leq 1.00\text{mm}$	2	Don't count	$\Phi > 1.00\text{mm}$	0	Don't count	Total quantity	4	Don't count	Minor													
Dimension (diameter : Φ)	Acceptance(Q'ty)																																			
	A area	B area																																		
$\Phi \leq 0.20\text{mm}$	Accept no dense	Don't count																																		
$0.20\text{mm} < \Phi \leq 0.50\text{mm}$	3	Don't count																																		
$0.50\text{mm} < \Phi \leq 1.00\text{mm}$	2	Don't count																																		
$\Phi > 1.00\text{mm}$	0	Don't count																																		
Total quantity	4	Don't count																																		
07	The crack of glass	<ul style="list-style-type: none"> ● Glass Crack: 7.1 Crack on the circuit of electrode terminal :  <table border="1" data-bbox="486 1792 1340 1948"> <thead> <tr> <th></th> <th>X</th> <th>Y</th> <th>Z</th> </tr> </thead> <tbody> <tr> <td>Front</td> <td>$X \leq 1/5 a$</td> <td>$Y \leq 1/2 D$</td> <td>$Z \leq t$</td> </tr> <tr> <td>Back</td> <td colspan="3">Neglect</td> </tr> </tbody> </table>		X	Y	Z	Front	$X \leq 1/5 a$	$Y \leq 1/2 D$	$Z \leq t$	Back	Neglect			Minor																					
	X	Y	Z																																	
Front	$X \leq 1/5 a$	$Y \leq 1/2 D$	$Z \leq t$																																	
Back	Neglect																																			

◆ Specification :

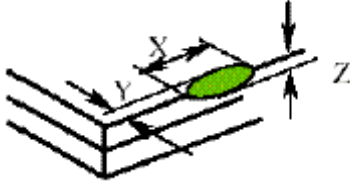
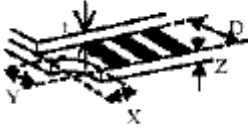
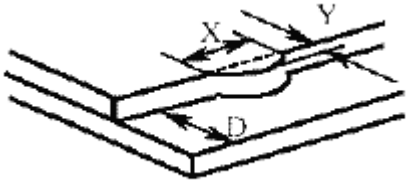
NO	Item	Criterion	Level												
07	<p>The crack of glass</p> <p>X: The length of Crack</p> <p>Y: The width of crack</p> <p>Z: The thickness of crack</p> <p>D: terminal length</p> <p>T: The thickness of glass</p> <p>A : The length of glass</p>	<p>● Glass Crack:</p> <p>7.2 General glass crack and corner edge:</p> <p>7.2.1</p>  <table border="1" data-bbox="552 824 1270 925"> <tr> <td>X</td> <td>Y</td> <td>Z</td> </tr> <tr> <td>Neglect</td> <td>Out A area</td> <td>Neglect</td> </tr> </table> <p>7.2.2</p>  <table border="1" data-bbox="552 1200 1270 1301"> <tr> <td>X</td> <td>Y</td> <td>Z</td> </tr> <tr> <td>Neglect</td> <td>Out A area</td> <td>Neglect</td> </tr> </table>	X	Y	Z	Neglect	Out A area	Neglect	X	Y	Z	Neglect	Out A area	Neglect	Minor
X	Y	Z													
Neglect	Out A area	Neglect													
X	Y	Z													
Neglect	Out A area	Neglect													
		<p>7.3 Glass remain:</p>  <table border="1" data-bbox="699 1776 1153 1877"> <tr> <td>X</td> <td>Y</td> </tr> <tr> <td>Neglect</td> <td>$\leq 1/3 d$</td> </tr> </table>	X	Y	Neglect	$\leq 1/3 d$	Minor								
X	Y														
Neglect	$\leq 1/3 d$														

◆ Specification :

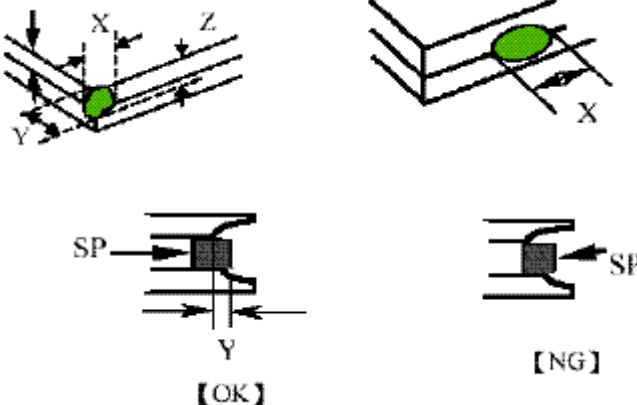
NO	Item	Criterion	Level									
07	<p>The crack of glass</p> <p>X: The length of Crack</p> <p>Y: The width of crack</p> <p>Z: The thickness of crack</p> <p>D: terminal length</p> <p>T: The thickness of glass</p> <p>A : The length of glass</p>	<p>7.4 Corner crack and medial crack:</p>  <table border="1" data-bbox="443 1025 1394 1220"> <thead> <tr> <th>X</th> <th>Y</th> <th>Z</th> </tr> </thead> <tbody> <tr> <td>$\leq 1/5a$</td> <td>Crack can't enter viewing area</td> <td>$\leq 1/2t$</td> </tr> <tr> <td>$\leq 1/5a$</td> <td>Crack can't exceed the half of width of SP</td> <td>$1/2t < Z \leq 2t$</td> </tr> </tbody> </table>	X	Y	Z	$\leq 1/5a$	Crack can't enter viewing area	$\leq 1/2t$	$\leq 1/5a$	Crack can't exceed the half of width of SP	$1/2t < Z \leq 2t$	Minor
X	Y	Z										
$\leq 1/5a$	Crack can't enter viewing area	$\leq 1/2t$										
$\leq 1/5a$	Crack can't exceed the half of width of SP	$1/2t < Z \leq 2t$										
08	Backlight elements	8.1 Backlight can't work normally.	Major									
		8.2 Backlight doesn't light or color is wrong.	Major									
		8.3 Illumination source flickers when lit.	Major									
09	General appearance	9.1 pin type must match type in specification sheet	Major									
		9.2 No short circuits in components on PCB or FPC	Major									
		9.3 Product packaging must be the same as specified on packaging specification sheet.	Major									
		9.4 The folding and peeled off in polarizer are not acceptable	Major									
		9.5 The PCB or FPC between B/L assembled distance (PCB or FPC) is $\leq 1.5\text{mm}$	Major									

4. RELIABILITY TEST

4.1 Reliability Test Condition

NO.	TEST ITEM	TEST CONDITION										
1	High Temperature Storage Test	Keep in 70 ±2°C 96 hrs Surrounding temperature, then storage at normal condition 4hrs										
2	Low Temperature Storage Test	Keep in -20 ±2°C 96 hrs Surrounding temperature, then storage at normal condition 4hrs										
3	High Humidity Storage	Keep in +60°C/90%RH duration for 96 hrs Surrounding temperature, then storage at normal condition 4hrs (Excluding the polarizer)Or Keep in +40°C/90%RH duration for 96 hrs Surrounding temperature, then storage at normal condition 4hrs										
4	Vibration Test	1. Sine wave 10~55HZ frequency (1 min) 2. The amplitude of vibration :1.5 mm 3. Each direction (XYZ) duration for 2 Hrs										
5	ESD Test	Air Discharge: Apply 6 KV with 5 times Discharge foreach polarity +/-										
		Contact Discharge: Apply 250V with 5 times discharge foreach polarity +/-										
6	Temperature Cycling Test	1. Temperature ambinace:15°C ~ 35°C 2. Humidity relative:30%~60% 3. Energy Storage Capacitance(Cs+Cd):150pF±10% 4. Discharge Resistance(Rd):330 Ω±10% 5. Discharge, mode of operation: Single Discharge (time between successive discharges at least 1 s) (Tolerance If the output voltage indication: ±5%)										
7	Temperature Cycling Test	-20°C → 25°C → 70°C → 25°C (30mins) (5mins) (30mins) (5mins) 10 Cycle Surrounding temperature, then storage at normal condition 4hrs										
8	Vibration Test (Packaged)	1. Sine wave 10~55HZ frequency (1 min) 2. The amplitude of vibration :1.5 mm 3. Each direction (XYZ) duration for 2 Hrs										
8	Drop Test (Packaged)	<table border="1"> <thead> <tr> <th>Packing Weight (Kg)</th> <th>Drop Height (cm)</th> </tr> </thead> <tbody> <tr> <td>0 ~ 45.4</td> <td>122</td> </tr> <tr> <td>45.4 ~ 90.8</td> <td>76</td> </tr> <tr> <td>90.8 ~ 454</td> <td>61</td> </tr> <tr> <td>Over 454</td> <td>46</td> </tr> </tbody> </table> <p>Drop direction :※3 comer /1 edges /6 sides etch 1times</p>	Packing Weight (Kg)	Drop Height (cm)	0 ~ 45.4	122	45.4 ~ 90.8	76	90.8 ~ 454	61	Over 454	46
Packing Weight (Kg)	Drop Height (cm)											
0 ~ 45.4	122											
45.4 ~ 90.8	76											
90.8 ~ 454	61											
Over 454	46											

5. PRECAUTION RELATING PRODUCT HANDLING

5.1 SAFETY

- 5.1.1 If the LCD panel breaks , be careful not to get the liquid crystal to touch your skin.
- 5.1.2 If the liquid crystal touches your skin or clothes , please wash it off immediately by using soap and water.

5.2 HANDLING

- 5.2.1 Avoid any strong mechanical shock which can break the glass.
- 5.2.2 Avoid static electricity which can damage the CMOS LSI—When working with the module , be sure to ground your body and any electrical equipment you may be using.
- 5.2.3 Do not remove the panel or frame from the module.
- 5.2.4 The polarizing plate of the display is very fragile. So , please handle it very carefully ,do not touch , push or rub the exposed polarizing with anything harder than an HB pencil lead (glass , tweezers , etc.)
- 5.2.5 Do not wipe the polarizing plate with a dry cloth , as it may easily scratch the surface of plate.
- 5.2.6 Do not touch the display area with bare hands , this will stain the display area.
- 5.2.7 Do not use ketonics solvent & aromatic solvent. Use with a soft cloth soaked with a cleaning naphtha solvent.
- 5.2.8 To control temperature and time of soldering is $320\pm 10^{\circ}\text{C}$ and 3-5 sec.
- 5.2.9 To avoid liquid (include organic solvent) stained on LCM .

5.3 STORAGE

- 5.3.1 Store the panel or module in a dark place where the temperature is $25^{\circ}\text{C} \pm 5^{\circ}\text{C}$ and the humidity is below 65% RH.
- 5.3.2 Do not place the module near organics solvents or corrosive gases.
- 5.3.3 Do not crush , shake , or jolt the module.

5.4 TERMS OF WARRANTY

- 5.4.1 Applicable warrant period
The period is within thirteen months since the date of shipping out under normal using and storage conditions.

- 5.4.2 Unaccepted responsibility
This product has been manufactured to your company's specification as a part for use in your company's general electronic products. It is guaranteed to perform according to delivery specifications. For any other use apart from general electronic equipment , we cannot take responsibility if the product is used in nuclear power control equipment , aerospace equipment , fire and security systems or any other applications in which there is a direct risk to human life and where extremely high levels of reliability are required.

X-ON Electronics

Largest Supplier of Electrical and Electronic Components

Click to view similar products for powertip manufacturer:

Other Similar products are found below :

[PH320240T023-IHC01](#) [PH800480T024-IDB01](#) [PH102600T003-IBC01](#) [PH800480T024-IDC01](#) [PH800480T013-IHA](#) [PH800480T024-IDA01](#)
[PH800480T013-IHA02](#) [PH320240T023-IHC](#) [PH480272T009-IHA01](#) [PH800480T024-IHC](#) [NPC1602LRU-JWT-H](#) [PG12864LRS-KCN-H-Q](#)
[PC1602LRS-FWA-B-Q](#) [PH480272T009-IBB](#) [PH800480T013-IHC01](#) [PH800480T024-IHA](#) [NPC1602WRP-FWT-I](#) [NPC2002WRP-BWT-I](#)
[PC1602LRU-LNH-B-Q](#) [NPC1602LRU-FWT-H](#) [PH320240T023-IHB](#) [PH800480T024-IHB](#) [PH800480T024-IHA01](#) [PC2002LRU-BWB-H-Q](#)
[PH480272T009-IBD](#) [PH320240T023-IHC09](#) [PH800480T013-IHA01](#) [PH800480T013-IHA06](#) [PH720128T004-ZBC02](#) [PC1601LRU-AWB-B-Q](#)
[PH480272T009-IHC](#) [PH128800T004-ZFA01](#) [PH320240T023-IHA01](#) [PH720128T003-ZBC02](#) [PC2402LRS-AWT-H-Q](#) [NPC2004WRP-AWA-I](#)
[PH800480T013-IHC](#) [PC1602LRU-HWB-H-Q](#) [PH240320T-062-L06Q](#) [PG12864LRU-FGAH04Q](#) [NPC1602LRU-FWB-H](#)
[PH800480T013-IBB01](#) [PH128800T004-ZFC](#) [PH320240T023-IHA03](#) [NPC1602LRU-GWT-H](#) [PC1604LRS-AWA-B-Q](#) [NPC1602LRS-FWT-H](#)
[NPC2002WRP-BWA-I](#) [PC2002LRU-BWT-H-Q](#) [PE12864LRF-042-H-Q](#)