

This document is the property of Amphenol Corporation and is delivered on the express condition that it is not to be disclosed, reproduced or used, in whole or in part, for manufacture or sale by anyone other than Amphenol Corporation without the prior consent, in that no right is granted to disclose or to use any information in this document.

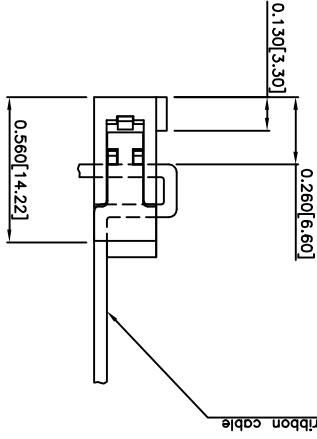
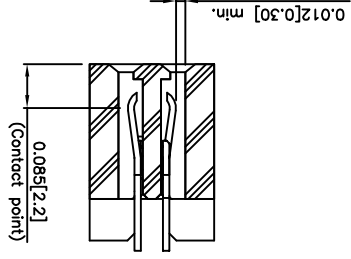
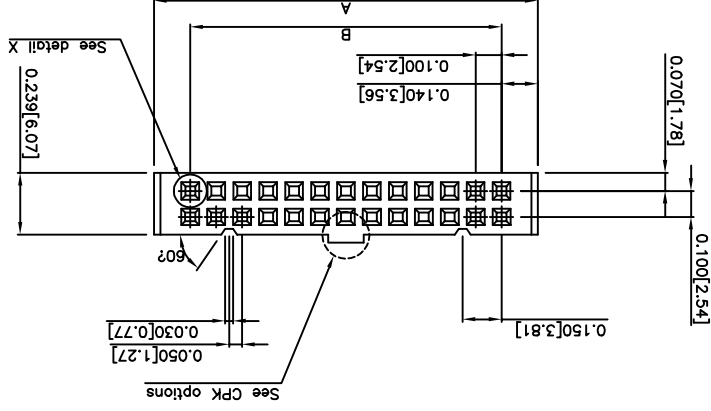
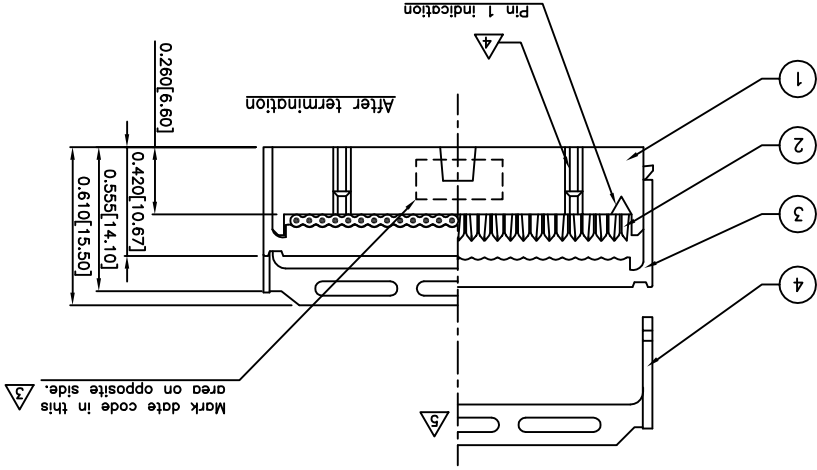

Note: Unit in inch [mm]

DIMENSIONS	
U.S.	INCHES
METRIC	MM
REMOVE SHARP EDGES	
SEE NOTES	
FOR MATERIALS AND FINISHES	
ANGLES +/-	2.5°
FRACTIONS	+/- 2.5°
X	+/- 0.20
.XX	+/- 0.10
.XXX	+/- 0.05
.XXXX	+/- 0.13
TOLERANCES UNLESS OTHERWISE SPECIFIED	
U.S. METRIC	
APPROVAL	DATE
ALEX.LEE	07/18/05
CHECKED	TSUI
CHECKED	07/18/05
DRAWING FILE: \DRAWING\812\812.dwg	
ANGLE OF PROJECTION	

TITLE	
812 Series Connector	
SIZE	A3
DRAWING NO.	C812-XXXX-XXX
REV.	M
SCALE 2 : 1	
SHEET 1 OF 2	

ITEM NO	PART OR IDENTIFICATION NO	DESCRIPTION	QTY REQ'D
1	-	Insulator Body	1
2	-	Contact	XX
3	-	Cover	1
4	-	Strain Relief (optional)	(1)

Customer Drawing

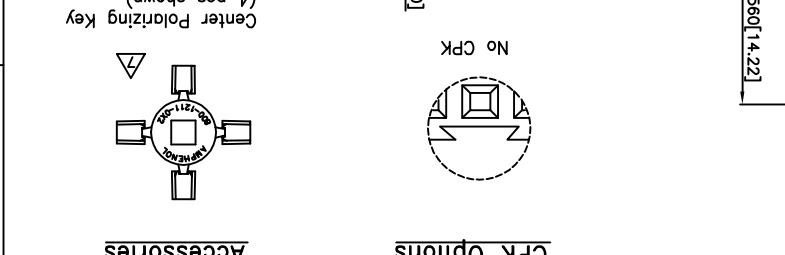
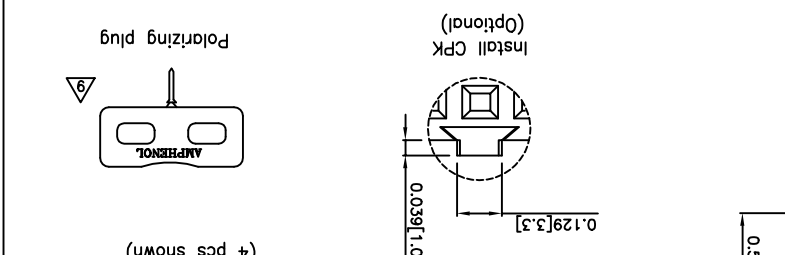
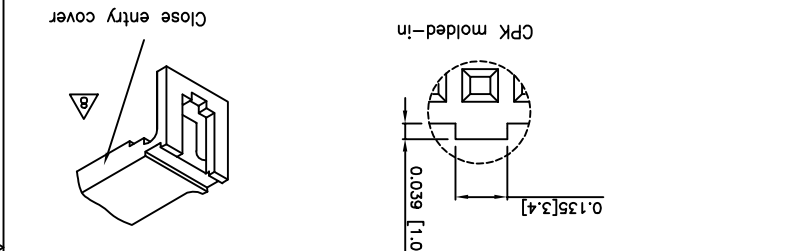

REVISIONS	
S/M	E/CN
L	HK1406
M	HK3437
RELEASE TO CUSTOMER	
UPDATE DRAWING TO COMPLY WITH ROHS	
DATE	
05/05/97	
APPROVED	
NELSON	
DATE	
07/18/05	
IP	

X-ON Electronics

Largest Supplier of Electrical and Electronic Components

Click to view similar products for [FFC & FPC Connectors](#) category:

Click to view products by [Amphenol](#) manufacturer:

Other Similar products are found below :

[HFW11R-1STE1H1LF](#) [FH29B-100S-0.2SHW\(99\)](#) [FA5S008HP1](#) [FH29B-120S-0.2SHW\(99\)](#) [FH29B-80S-0.2SHW\(99\)](#) [FHS-16](#) [FPH-2022G](#)
[52610-1075](#) [52610-1275](#) [52610-1934](#) [XF3M\(1\)-1415-1B-R100](#) [501864-3091-TR225](#) [0525594033](#) [086210010340800](#) [086222026001800](#)
[52271-2869-CUT-TAPE](#) [62674-201121DLF](#) [62684-36210E9ALF](#) [52610-1675](#) [52746-1671-TR250](#) [10051922-2810EHLF](#) [6-520415-9](#)
[BD021-09A-A1-0350-0200-0550-LD](#) [SFV6R-1STE9HLF](#) [XF3M-2915-1B-R100](#) [1658549-1](#) [62674-221121ALF](#) [46214008010800](#)
[046298003000883](#) [151660622](#) [842-816-2630-035](#) [AYF530665TA](#) [AYF351525](#) [046296011930846+](#) [AYF352325A](#) [046254020000800+](#)
[FH19C-13S-0.5SH\(99\)](#) [FH39J-51S-0.3SHW\(99\)](#) [AYF355125A](#) [AYF530365TA](#) [FH29B-44S-0.2SHW\(99\)](#) [SFW5R-2STAE9LF](#) [AYF351125A](#)
[AYF350725A](#) [62684-502100AHLF](#) [FH39-61S-0.3SHW\(99\)](#) [AYF414035A](#) [10064555-172520HLF](#) [AYF212335A](#) [504754-2500](#)