

Features

- 1 & 2 Pole relay interface modules**
- 5 µm Gold plate contacts for low level switching capability**
- 49.31-50x0 - 1 Pole 10 A (screw terminal)
 - 49.52-50x0 - 2 Pole 8 A (screw terminal)
 - 49.72-50x0 - 2 Pole 8 A (screwless terminal)
- 15.5 mm wide
 - Ideal interface for PLC and electronic systems
 - AC coils & DC coils
 - Instant ejection of relay using plastic retaining clip
 - Supply status indication and coil suppression module
 - Identification labels
 - 35 mm rail (EN 50022) mounting

49.31-50x0 / 49.52
Screw terminal

49.72-50x0
Screwless terminal



For outline drawing see page 8

Contact specification		49.31-50x0	49.52/72-50x0
Contact configuration		1 CO (SPDT)	2 CO (DPDT)
Rated current/Maximum peak current	A	10/20	8/15
Rated voltage/Maximum switching voltage V AC		250/400	250/250
Rated load AC1	VA	2,500	2,000
Rated load AC15 (230 V AC)	VA	500	400
Single phase motor rating (230 V AC)	kW	0.37	0.3
Breaking capacity DC1: 30/110/220V	A	10/0.3/0.12	8/0.3/0.12
Minimum switching load	mW (V/mA)	50 (5/2)	50 (5/2) - [1 (0.1/1)]*
Standard contact material		AgNi + Au (5 µm)	AgNi + Au (5 µm)
Coil specification			
Nominal voltage (U _N)	V AC (50/60 Hz)	12 - 24 - 110 - 120 - 230	12 - 24 - 110 - 120 - 230
	V DC	12 - 24 - 125	12 - 24 - 125
Rated power AC/DC/sens.DC	VA (50 Hz)/W/W	1.2/0.65/0.5	1.2/0.65/0.5
Operating range	AC	(0.8...1.1)U _N	(0.8...1.1)U _N
	DC/sensitiv DC	(0.73...1.5)U _N /(0.73...1.7)U _N	(0.73...1.5)U _N /(0.73...1.7)U _N
Holding voltage	AC/DC	0.8 U _N / 0.4 U _N	0.8 U _N / 0.4 U _N
Must drop-out voltage	AC/DC	0.2 U _N / 0.1 U _N	0.2 U _N / 0.1 U _N
Technical data			
Mechanical life AC/DC	cycles	10 · 10 ⁶ /20 · 10 ⁶	10 · 10 ⁶ /20 · 10 ⁶
Electrical life at rated load AC1	cycles	150 · 10 ³	150 · 10 ³
Operate/release time	ms	7/4 (AC) - 12/12 (DC)	7/4 (AC) - 12/12 (DC)
Insulation between coil and contacts (1.2/50 µs)	kV	6 (8 mm)	6 (8 mm)
Dielectric strength between open contacts V AC		1,000	1,000
Ambient temperature range	°C	-40...+70	-40...+70
Protection category		IP 20	IP 20
Approvals relay (according to type)			

49.31-50x0



- 1 pole, 10 A
- AgNi + Au (5 µm) contact material
- Screw terminal
- 35 mm rail (EN 50022) mounting

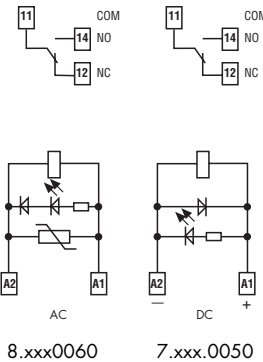

49.52/72-50x0



- 2 pole, 8 A
- AgNi + Au (5 µm) contact material
- Screw terminal and screwless terminal
- 35 mm rail (EN 50022) mounting

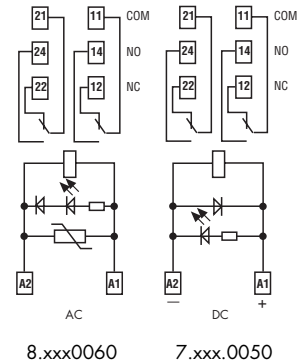

** By external parallel connection of the contacts the values within [1 (0.1/1)] can be achieved.

Features

1 & 2 Pole relay interface modules

AgNi contacts for medium duty switching

49.31-00x0 - 1 Pole 10 A (screw terminal)

49.52-00x0 - 2 Pole 8 A (screw terminal)

49.72-00x0 - 2 Pole 8 A (screwless terminal)

- 15.5 mm wide
- Ideal interface for PLC and electronic systems
- AC coils & DC coils
- Instant ejection of relay using plastic retaining clip
- Supply status indication and coil suppression module
- Identification labels
- 35 mm rail (EN 50022) mounting

49.31-00x0 / 49.52
Screw terminal

49.72-00x0
Screwless terminal



49.31-00x0



- 1 pole, 10 A
- AgNi contact material
- Screw terminal
- 35 mm rail (EN 50022) mounting

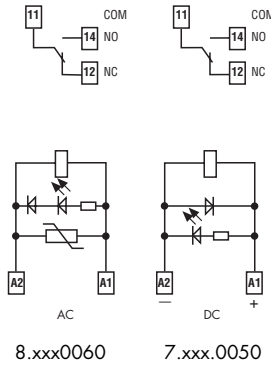

49.52/72-00x0



- 2 pole, 8 A
- AgNi contact material
- Screw terminal and screwless terminal
- 35 mm rail (EN 50022) mounting

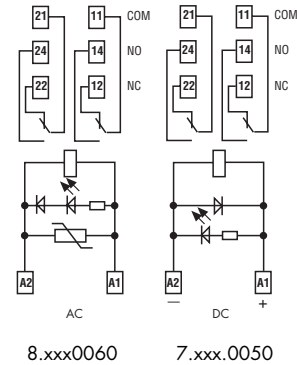

For outline drawing see page 8

Contact specification		1 CO (SPDT)	2 CO (DPDT)
Contact configuration		1 CO (SPDT)	2 CO (DPDT)
Rated current/Maximum peak current	A	10/20	8/15
Rated voltage/Maximum switching voltage	V AC	250/400	250/250
Rated load AC1	VA	2,500	2,000
Rated load AC15 (230 V AC)	VA	500	400
Single phase motor rating (230 V AC)	kW	0.37	0.3
Breaking capacity DC1: 30/110/220V	A	10/0.3/0.12	8/0.3/0.12
Minimum switching load	mW (V/mA)	300 (5/5)	300 (5/5)
Standard contact material		AgNi	AgNi
Coil specification			
Nominal voltage (U _N)	V AC (50/60 Hz)	12 - 24 - 110 - 120 - 230	12 - 24 - 110 - 120 - 230
	V DC	12 - 24 - 125	12 - 24 - 125
Rated power AC/DC/sens.DC	VA (50 Hz)/W/W	1.2/0.65/0.5	1.2/0.65/0.5
Operating range	AC	(0.8...1.1)U _N	(0.8...1.1)U _N
	DC/sensitiv DC	(0.73...1.5)U _N / (0.73...1.7)U _N	(0.73...1.5)U _N / (0.73...1.7)U _N
Holding voltage	AC/DC	0.8 U _N / 0.4 U _N	0.8 U _N / 0.4 U _N
Must drop-out voltage	AC/DC	0.2 U _N / 0.1 U _N	0.2 U _N / 0.1 U _N
Technical data			
Mechanical life AC/DC	cycles	10 · 10 ⁶ / 20 · 10 ⁶	10 · 10 ⁶ / 20 · 10 ⁶
Electrical life at rated load AC1	cycles	200 · 10 ³	150 · 10 ³
Operate/release time	ms	7/4 (AC) - 12/12 (DC)	7/4 (AC) - 12/12 (DC)
Insulation between coil and contacts (1.2/50 μs)	kV	6 (8 mm)	6 (8 mm)
Dielectric strength between open contacts	V AC	1,000	1,000
Ambient temperature range	°C	-40...+70	-40...+70
Protection category		IP 20	IP 20

Approvals relay (according to type)



Features

- 1 & 2 Pole relay interface modules**
- AgCdO contacts for heavy duty switching**
- 49.31-20x0 - 1 Pole 10 A (screw terminal)**
 - 49.52-20x0 - 2 Pole 8 A (screw terminal)**
 - 49.72-20x0 - 2 Pole 8 A (screwless terminal)**
- 15.5 mm wide
 - Ideal interface for PLC and electronic systems
 - AC coils & DC coils
 - Instant ejection of relay using plastic retaining clip
 - Supply status indication and coil suppression module
 - Identification labels
 - 35 mm rail (EN 50022) mounting

49.31-20x0 / 49.52
Screw terminal

49.72-20x0
Screwless terminal



For outline drawing see page 8

Contact specification		49.31-20x0	49.52/72-20x0
Contact configuration		1 CO (SPDT)	2 CO (DPDT)
Rated current/Maximum peak current	A	10/20	8/15
Rated voltage/Maximum switching voltage	V AC	250/400	250/250
Rated load AC1	VA	2,500	2,000
Rated load AC15 (230 V AC)	VA	500	400
Single phase motor rating (230 V AC)	kW	0.37	0.3
Breaking capacity DC1: 30/110/220V	A	10/0.3/0.12	8/0.3/0.12
Minimum switching load	mW (V/mA)	500 (10/5)	500 (10/5)
Standard contact material		AgCdO	AgCdO
Coil specification			
Nominal voltage (U _N)	V AC (50/60 Hz)	12 - 24 - 110 - 120 - 230	12 - 24 - 110 - 120 - 230
	V DC	12 - 24 - 125	12 - 24 - 125
Rated power AC/DC/sens.DC	VA (50 Hz)/W/W	1.2/0.65/0.5	1.2/0.65/0.5
Operating range	AC	(0.8...1.1)U _N	(0.8...1.1)U _N
	DC/sensitiv DC	(0.73...1.5)U _N /(0.73...1.75)U _N	(0.73...1.5)U _N /(0.73...1.75)U _N
Holding voltage	AC/DC	0.8 U _N / 0.4 U _N	0.8 U _N / 0.4 U _N
Must drop-out voltage	AC/DC	0.2 U _N / 0.1 U _N	0.2 U _N / 0.1 U _N
Technical data			
Mechanical life AC/DC	cycles	10 · 10 ⁶ / 20 · 10 ⁶	10 · 10 ⁶ / 20 · 10 ⁶
Electrical life at rated load AC1	cycles	200 · 10 ³	150 · 10 ³
Operate/release time	ms	7/4 (AC) - 12/12 (DC)	7/4 (AC) - 12/12 (DC)
Insulation between coil and contacts (1.2/50 μs)	kV	6 (8 mm)	6 (8 mm)
Dielectric strength between open contacts	V AC	1,000	1,000
Ambient temperature range	°C	-40...+70	-40...+70
Protection category		IP 20	IP 20
Approvals relay (according to type)			

49.31-20x0



- 1 pole, 10 A
- AgCdO contact material
- Screw terminal
- 35 mm rail (EN 50022) mounting

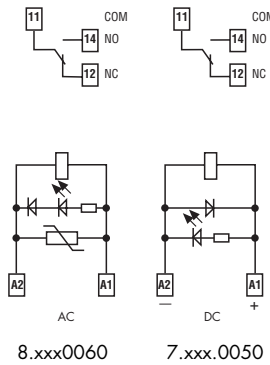

49.52/72-20x0



- 2 pole, 8 A
- AgCdO contact material
- Screw terminal and screwless terminal
- 35 mm rail (EN 50022) mounting

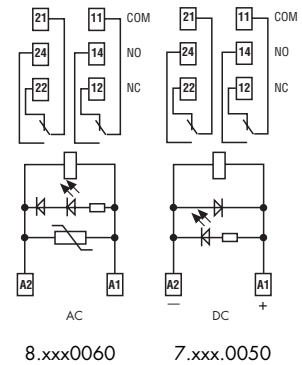

Features

1 Pole relay interface module

AgCdO contacts for heavy duty switching

49.61-20x0 - 1 Pole 16 A (screw terminal)

49.81-20x0 - 1 Pole 16 A (screwless terminal)

AgSnO₂ contacts for heavy duty, high current inrush switching

49.61-40x0 - 1 Pole 16 A (screw terminal)

49.81-40x0 - 1 Pole 16 A (screwless terminal)

- 15.5 mm wide
- Ideal interface for PLC and electronic systems
- AC coils & DC coils
- Instant ejection of relay using plastic retaining clip
- Supply status indication and coil suppression module
- Identification labels
- 35 mm rail (EN 50022) mounting

49.61
Screw terminal



49.81-20x0/40x0
Screwless terminal



For outline drawing see page 8

Contact specification

Contact configuration	1 CO (SPDT)	1 CO (SPDT)
Rated current/Maximum peak current A	16*/30	16*/100 (5 ms)
Rated voltage/Maximum switching voltage V AC	250/400	250/400
Rated load AC1 VA	4,000	4,000
Rated load AC15 (230 V AC) VA	750	750
Single phase motor rating (230 V AC) kW	0.55	0.55
Breaking capacity DC1: 30/110/220V A	16/0.3/0.12	16/0.3/0.12
Minimum switching load mW (V/mA)	500 (5/5)	1,000 (10/10)
Standard contact material	AgCdO	AgSnO ₂

Coil specification

Nominal voltage (U _N)	V AC (50/60 Hz)	12 - 24 - 110 - 120 - 230	12 - 24 - 110 - 120 - 230
	V DC	12 - 24 - 125	12 - 24 - 125
Rated power AC/DC/sens.DC VA (50 Hz)/W/W		1.2/0.65/0.5	1.2/0.65/0.5
Operating range	AC	(0.8...1.1)U _N	(0.8...1.1)U _N
	DC/sensitiv DC	(0.73...1.5)U _N /(0.8...1.5)U _N	(0.73...1.5)U _N /(0.8...1.5)U _N
Holding voltage AC/DC		0.8 U _N /0.4 U _N	0.8 U _N /0.4 U _N
Must drop-out voltage AC/DC		0.2 U _N /0.1 U _N	0.2 U _N /0.1 U _N

Technical data

Mechanical life AC/DC	cycles	10 · 10 ⁶ /20 · 10 ⁶	10 · 10 ⁶ /20 · 10 ⁶
Electrical life at rated load AC1	cycles	100 · 10 ³	100 · 10 ³
Operate/release time	ms	7/4 (AC) - 12/12 (DC)	7/4 (AC) - 12/12 (DC)
Insulation between coil and contacts (1.2/50 μs)	kV	6 (8 mm)	6 (8 mm)
Dielectric strength between open contacts	V AC	1,000	1,000
Ambient temperature range	°C	-40...+70	-40...+70
Protection category		IP 20	IP 20

Approvals relay (according to type)

49.61/81-20x0



- 1 pole, 16 A
- AgCdO contact material
- Screw terminal and screwless terminal
- 35 mm rail (EN 50022) mounting

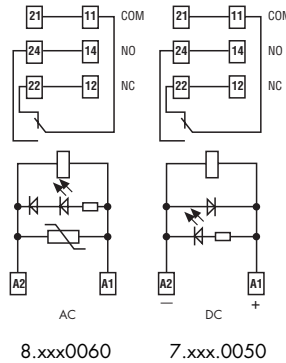

* For currents >10 A, contact terminals must be connected in parallel (21 with 11, 24 with 14, 22 with 12).

49.61/81-40x0



- 1 pole, 16 A
- AgSnO₂ contact material
- Screw terminal and screwless terminal
- 35 mm rail (EN 50022) mounting

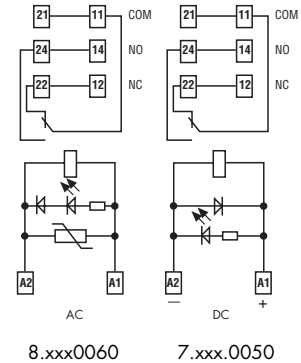

* For currents >10 A, contact terminals must be connected in parallel (21 with 11, 24 with 14, 22 with 12).

Ordering information

Example: 49 series, 35 mm rail (EN 50022) mount screw terminal relay interface module, 2 CO (DPDT) 8 A contacts, 24 V sensitive DC coil, green LED + diode (polarity +A1), 99.80 coil indication.

	4	9	.	5	2	.	7	.	0	2	4	.	0	0	5	0
<p>Series</p> <p>Type 3, 5, 6 = 35 mm rail (EN 50022) mount, screw terminal 7, 8 = 35 mm rail (EN50022) mount, screwless terminal</p> <p>No. of poles 1 = 1 pole for 49.31, 10 A 49.61, 49.81, 16 A 2 = 2 pole for 49.52, 49.72, 8 A</p> <p>Coil version 7 = Sensitive DC (500 mW) 8 = AC (50/60 Hz) 9 = DC (650 mW)</p> <p>Coil voltage See coil specifications</p>				<p>A: Contact material 0 = Standard AgNi for 49.31/52/72, AgCdO for 49.61/81 2 = AgCdO for 49.31/52/72 4 = AgSnO₂ for 49.61/81 only 5 = AgNi + Au (5 μm) not for 49.61/81</p> <p>B: Contact circuit 0 = CO (nPDT)</p>				<p>C: Options 5 = Standard for DC: green LED + diode (polarity +A1) 6 = Standard for AC: green LED + Varistor</p> <p>D: Special versions 0 = Standard</p>								

Selecting features and options: only combinations in the same row are possible.
Preferred selections for best availability are shown in **bold**.

Type	Coil version	A	B	C	D
49.31/52/72	AC	0 - 2 - 5	0	6	0
49.31/52/72	DC	0 - 2 - 5	0	5	0
49.61/81	AC	0 - 4	0	6	0
49.61/81	DC	0 - 4	0	5	0

Technical data

Insulation		49.31/61	49.52/72	49.31/61/81
Insulation according to EN 61810-1	insulation rated voltage	V	250	250
	rated impulse withstand voltage	kV	4	4
	pollution degree		3	2
	overvoltage category		III	III
Insulation between coil and contacts (1.2/50 μs)		kV	6 (8 mm)	
Dielectric strength between open contacts		V AC	1,000	
Dielectric strength between adjacent contacts		V AC	2,000 (49.52/72)	
Conducted disturbance immunity				
Burst (5...50)ns, 5 kHz, on A1 - A2			EN 61000-4-4	level 4 (4 kV)
Surge (1.2/50 μs) on A1 - A2 (differential mode)			EN 61000-4-5	level 3 (2 kV)
Other data				
Bounce time: NO/NC		ms	2/5	
Vibration resistance (5...55)Hz: NO/NC		g	10/4 (for 1 pole)	15/3 (for 2 pole)
Power lost to the environment				
		without contact current	W	
		with rated current	W	1.2 (49.31/61/81) 1.3 (49.52/72)
Wire strip length		mm	8	
Screw torque		Nm	0.5	
Max. wire size				
			Screw terminal	
			Screwless terminal	
		solid cable	stranded cable	solid cable
		stranded cable	solid cable	stranded cable
		mm ²	1x6 / 2x2.5	1x4 / 2x2.5
		mm ²	2x(0.2...1.5)	2x(0.2...1.5)
		AWG	1x10 / 2x14	1x12 / 2x14
			2x(24...18)	2x(24...18)

Contact specification

F 49 - Electrical life (AC) v contact current
Types 49.31/61/81

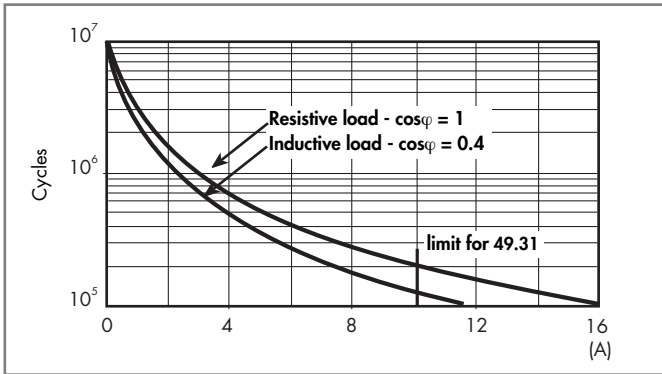

F 49 - Electrical life (AC) v contact current
Types 49.52/72

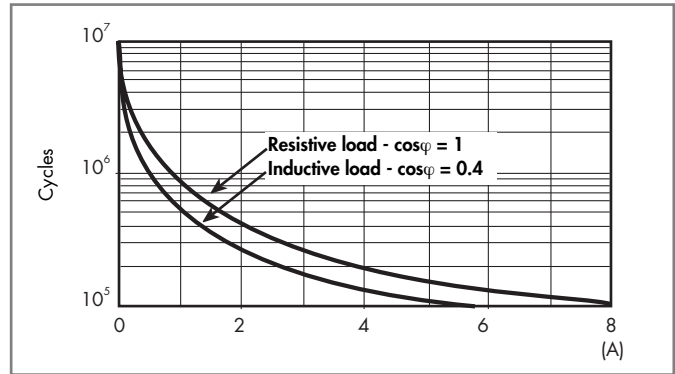

H 49 - Maximum DC1 breaking capacity
Types 49.31/52/61/72/81

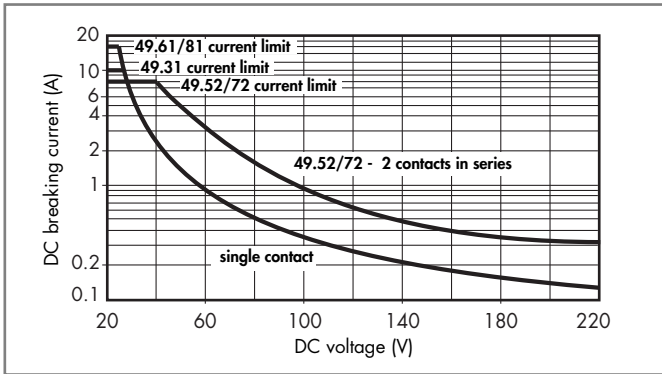

- When switching a resistive load (DC1) having voltage and current values under the curve, an electrical life of $\geq 100 \cdot 10^3$ can be expected.
- In the case of DC13 loads, the connection of a diode in parallel with the load will permit a similar electrical life as for a DC1 load.
Note: the release time for the load will be increased.

Coil specifications

DC coil data (0.5 W sensitive)

Nominal voltage U_N V	Coil code	Operating range		Rated coil consumption I at U_N mA
		U_{min}^* V	U_{max}^{**} V	
12	7.012	8.8	21	41
24	7.024	17.5	42	22.2
125	7.125	91.2	212.5	4

* $U_{min} = 0.8 U_N$ for 49.61 and 49.81

** $U_{max} = 1.5 U_N$ for 49.61 and 49.81

AC coil data

Nominal voltage U_N V	Coil code	Operating range		Rated coil consumption I at U_N (50Hz) mA
		U_{min} V	U_{max} V	
12	8.012	9.6	13.2	90.5
24	8.024	19.2	26.4	46
110	8.110	88	121	10.1
120	8.120	96	132	11.8
230	8.230	184	253	7.0

DC coil data (0.65 W)

Nominal voltage U_N V	Coil code	Operating range		Rated coil consumption I at U_N mA
		U_{min} V	U_{max} V	
12	9.012	8.8	18	56
24	9.024	17.5	36	29
125	9.125	91.2	187.5	6

R 49 - DC coil operating range v ambient temperature Standard (650 mW)

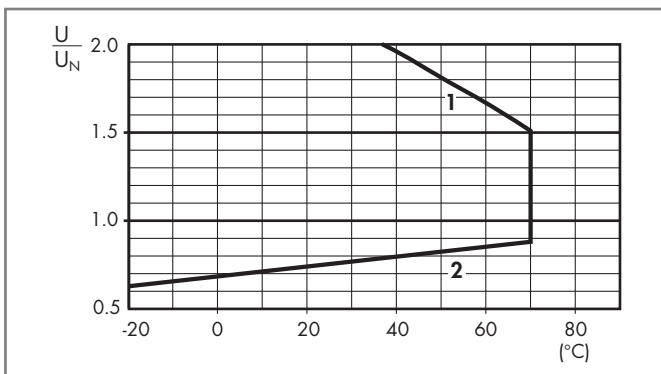

- 1 - Max. permitted coil voltage.
- 2 - Min. pick-up voltage with coil at ambient temperature.

R 49 - AC coil operating range v ambient temperature

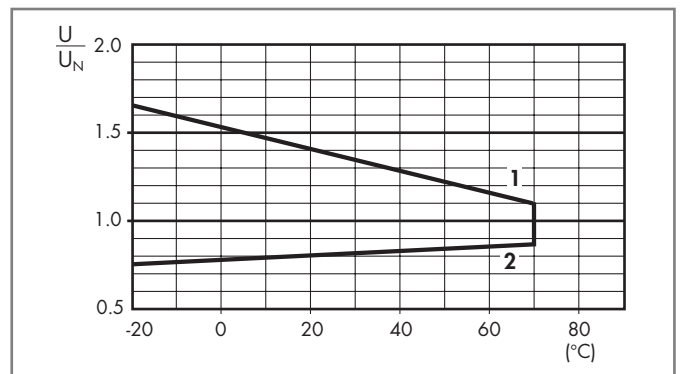

- 1 - Max. permitted coil voltage.
- 2 - Min. pick-up voltage with coil at ambient temperature.

R 49 - DC coil operating range v ambient temperature Sensitive coil (500 mW)

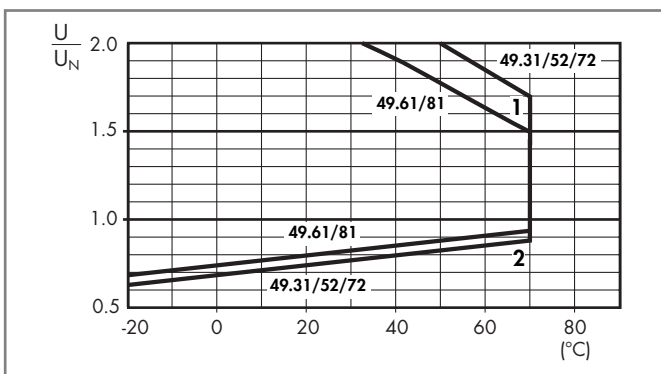

- 1 - Max. permitted coil voltage.
- 2 - Min. pick-up voltage with coil at ambient temperature.

Combinations

Code	Type of socket	Type of relay	Module	Retaining clip
49.31	95.93.3	40.31	99.80	095.91.3
49.52	95.95.3	40.52	99.80	095.91.3
49.61	95.95.3	40.61	99.80	095.91.3
49.72	95.55.3	40.52	99.80	095.91.3
49.81	95.55.3	40.61	99.80	095.91.3

Outline drawing

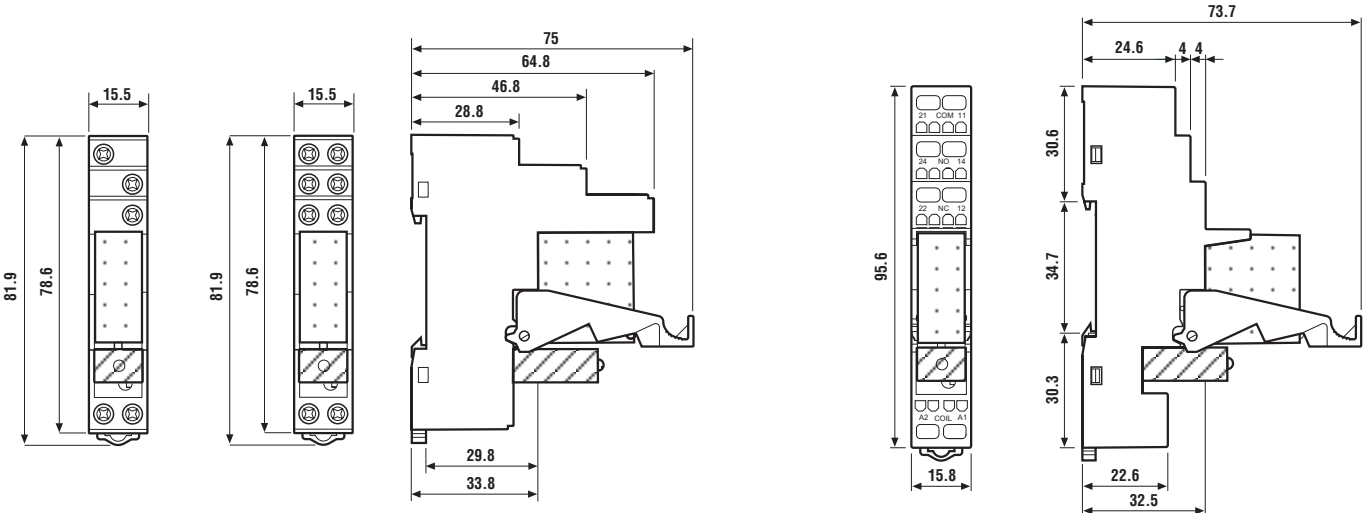

49.31 49.52
 49.61
 49.31-50x0 / 49.31-00x0 /
 49.31-20x0 / 49.52 / 49.61
 Screw terminal



49.72
 49.81
 49.72-50x0 / 49.72-00x0 / 49.72-20x0
 49.81-20x0 / 49.81-40x0
 Screwless terminal



Accessories

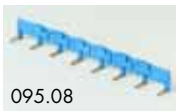

095.08

8-way jumper link for screw terminal versions	095.08 (blue)	095.08.0 (black)
Rated values	10 A - 250 V	

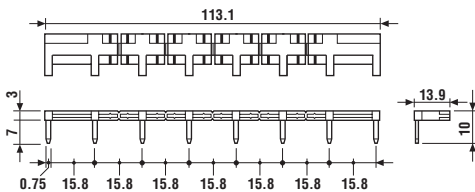

060.72

Sheet of marker tags , plastic, 72 tags, 6x12 mm	060.72
---	--------

Packaging codes

How to code and identify retaining clip and packaging options for sockets.

Example:

4 9 . 5 2 . 7 . 0 2 4 . 0 0 5 0 S P A

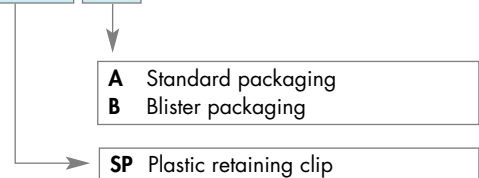

X-ON Electronics

Largest Supplier of Electrical and Electronic Components

Click to view similar products for [General Purpose Relays category](#):

Click to view products by [Finder manufacturer](#):

Other Similar products are found below :

[APF30318](#) [JVN1AF-4.5V-F](#) [PCN-105D3MHZ](#) [5JO-10000S-SIL](#) [5JO-1000CD-SIL](#) [5JO-400CD-SIL](#) [LY2S-AC220/240](#) [LYQ20DC12](#)
[6031007G](#) [6131406HQ](#) [6-1393099-3](#) [6-1393099-8](#) [6-1393122-4](#) [6-1393123-2](#) [6-1393767-1](#) [6-1393843-7](#) [6-1415012-1](#) [6-1419102-2](#) [6-](#)
[1423698-4](#) [6-1608051-6](#) [6-1608067-0](#) [6-1616170-6](#) [6-1616248-2](#) [6-1616282-3](#) [6-1616348-2](#) [6-1616350-1](#) [6-1616350-8](#) [6-1616358-7](#) [6-](#)
[1616359-9](#) [6-1616360-9](#) [6-1616931-6](#) [6-1617039-1](#) [6-1617052-1](#) [6-1617090-2](#) [6-1617090-5](#) [6-1617347-5](#) [6-1617353-3](#) [6-1617801-8](#) [6-](#)
[1617802-2](#) [6-1618107-9](#) [6-1618248-4](#) [M83536/1-027M](#) [CX-4014](#) [MAHC-5494](#) [MAVCD-5419-6](#) [703XCX-120A](#) [7-1393100-5](#) [7-1393111-7](#)
[7-1393144-5](#) [7-1393767-8](#)