

## Features

1 & 2 Pole relay interface modules,  
15.8 mm wide.

Ideal interface for PLC and electronic systems

- 48.31 - 1 Pole 10 A
- 48.52 - 2 Pole 8 A
- 48.61 - 1 Pole 16 A

- AC coils or DC sensitive coils
- Instant ejection of relay using plastic retaining clip
- Supply status indication and EMC coil suppression module as standard
- Identification label
- UL Listed
- 35 mm rail (EN 50022) mounting

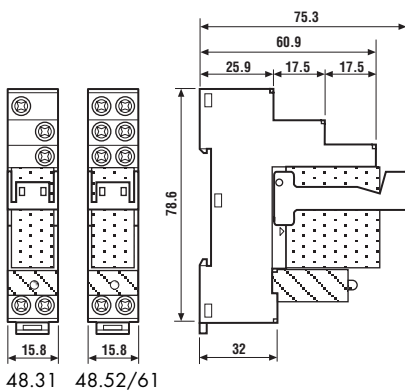

- 1 pole 10 A
- 35 mm rail mounting



- 2 pole 8 A
- 35 mm rail mounting



- 1 pole 16 A
- 35 mm rail mounting

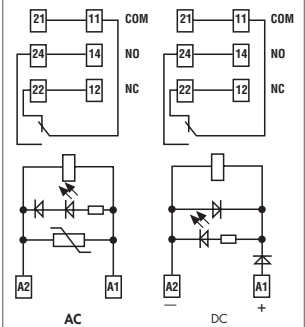
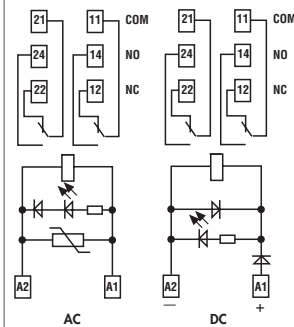
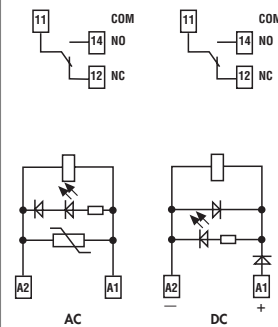

### Contact specification

Contact configuration	1 CO (SPDT)	2 CO (DPDT)	1 CO (SPDT)
Rated current/Maximum peak current A	10/20	8/15	16/30
Rated voltage/Maximum switching voltage V AC	250/400	250/250	250/400
Rated load AC1 VA	2,500	2,000	4,000
Rated load AC15 (230 V AC) VA	500	400	750
Single phase motor rating (230 V AC) kW	0.37	0.3	0.55
Breaking capacity DC1: 30/110/220V A	10/0.3/0.12	8/0.3/0.12	16/0.3/0.12
Minimum switching load mW (V/mA)	300 (5/5)	300 (5/5)	500 (10/5)
Standard contact material	AgNi	AgNi	AgCdO

### Coil specification

Nominal voltage (U <sub>N</sub> )	V AC (50/60 Hz)	12 - 24 - 110 - 120 - 230	12 - 24 - 110 - 120 - 230	12 - 24 - 110 - 120 - 230
	V DC	12 - 24 - 125	12 - 24 - 125	12 - 24 - 125
Rated power AC/sens. DC VA (50 Hz)/W		1.2/0.5	1.2/0.5	1.2/0.5
Operating range	AC	(0.8...1.1)U <sub>N</sub>	(0.8...1.1)U <sub>N</sub>	(0.8...1.1)U <sub>N</sub>
	sens. DC	(0.73...1.75)U <sub>N</sub>	(0.73...1.75)U <sub>N</sub>	(0.8...1.5)U <sub>N</sub>
Holding voltage	AC/DC	0.8 U <sub>N</sub> / 0.4 U <sub>N</sub>	0.8 U <sub>N</sub> / 0.4 U <sub>N</sub>	0.8 U <sub>N</sub> / 0.4 U <sub>N</sub>
Must drop-out voltage	AC/DC	0.2 U <sub>N</sub> / 0.1 U <sub>N</sub>	0.2 U <sub>N</sub> / 0.1 U <sub>N</sub>	0.2 U <sub>N</sub> / 0.1 U <sub>N</sub>

### Technical data

Mechanical life AC/DC	cycles	10 · 10 <sup>6</sup> /20 · 10 <sup>6</sup>	10 · 10 <sup>6</sup> /—	10 · 10 <sup>6</sup> /20 · 10 <sup>6</sup>
Electrical life at rated load AC1	cycles	200 · 10 <sup>3</sup>	100 · 10 <sup>3</sup>	100 · 10 <sup>3</sup>
Operate/release time	ms	7/4 (AC) - 12/12 (DC)	7/4 (AC) - 12/12 (DC)	7/4 (AC) - 12/12 (DC)
Insulation between coil and contacts (1.2/50 μs)	kV	6 (8 mm)	6 (8 mm)	6 (8 mm)
Dielectric strength between open contacts	V AC	1,000	1,000	1,000
Ambient temperature range	°C	-40...+70	-40...+70	-40...+70
Protection category		IP 20	IP 20	IP 20

Approvals relay (according to type)



## Features

**2 Pole relay interface module,  
15.8 mm wide.**

**Ideal interface for PLC and electronic systems**

### 48.62 - 2 Pole 10 A

- DC sensitive coil
- Instant ejection of relay using plastic retaining clip
- Supply status indication and EMC coil suppression module as standard
- Identification label
- Cadmium Free contacts
- UL Listed
- 35 mm rail (EN 50022) mounting

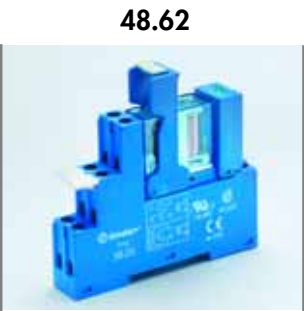

- 2 pole 10 A
- 35 mm rail mounting

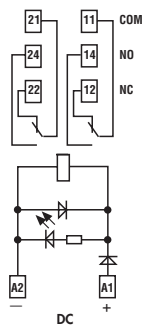
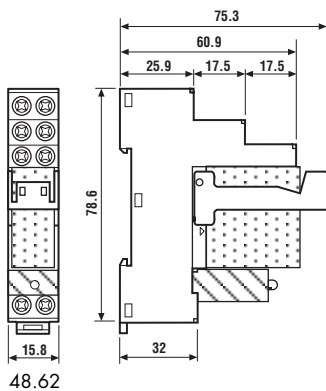

48

Contact specification		
Contact configuration		2 CO (DPDT)
Rated current/Maximum peak current	A	10/20
Rated voltage/Maximum switching voltage	V AC	250/400
Rated load AC1	VA	2,500
Rated load AC15 (230 V AC)	VA	500
Single phase motor rating (230 V AC)	kW	0.37
Breaking capacity DC1: 30/110/220V	A	10/0.3/0.12
Minimum switching load	mW (V/mA)	300 (5/5)
Standard contact material		AgNi
Coil specification		
Nominal voltage ( $U_N$ )	V AC (50/60 Hz)	—
	V DC	12 - 24 - 125
Rated power AC/sens. DC	VA (50 Hz)/W	—/0.5
Operating range	AC	—
	sens. DC	$(0.8 \dots 1.5)U_N$
Holding voltage	AC/DC	—/0.4 $U_N$
Must drop-out voltage	AC/DC	—/0.1 $U_N$
Technical data		
Mechanical life AC/DC	cycles	—/20 · 10 <sup>6</sup>
Electrical life at rated load AC1	cycles	100 · 10 <sup>3</sup>
Operate/release time	ms	12/12 (DC)
Insulation between coil and contacts (1.2/50 $\mu$ s)	kV	6 (8 mm)
Dielectric strength between open contacts	V AC	1,000
Ambient temperature range	°C	−40...+70
Protection category		IP 20
Approvals relay (according to type)		

## Ordering information

Example: 48 series, 35 mm rail (EN 50022) mount relay interface module, 2 CO (DPDT) 8 A contacts, 24 V sensitive DC coil, green LED + diode.

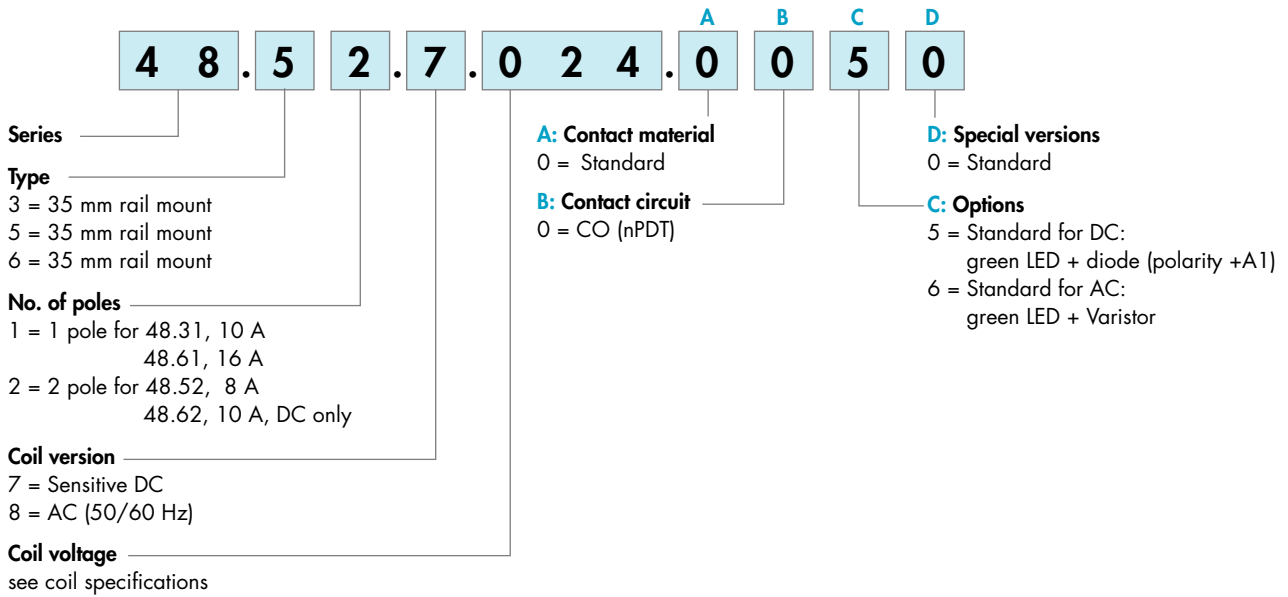

## Technical data

Insulation		48.31/61/62	48.52	48.31/52/61/62	
Insulation according to EN 61810-1 ed. 2	insulation rated voltage	V	250	250	400
	rated impulse withstand voltage	kV	4	4	4
	pollution degree		3	2	2
	overvoltage category		III	III	III
Insulation between coil and contacts (1.2/50 μs)	kV	6 (8 mm)			
Dielectric strength between open contacts	V AC	1,000			
Dielectric strength between adjacent contacts	V AC	2,000 (48.52); 2,500 (48.62)			
Conducted disturbance immunity					
Burst (5...50)ns, 5 kHz, on A1 - A2		EN 61000-4-4		level 4 (4 kV)	
Surge (1.2/50 μs) on A1 - A2 (differential mode)		EN 61000-4-5		level 3 (2 kV)	
Other data					
Bounce time: NO/NC	ms	2/5			
Vibration resistance (5...55)Hz, max. ± 1 mm: NO/NC	g/g	10/4 (for 1 pole)		15/3 (for 2 pole)	
Power lost to the environment	without contact current	W	0.7		
	with rated current	W	1.2 (48.31)	1.3 (48.52)	1.2 (48.61)   1.2 (48.62)
Wire strip length	mm	8			
Screw torque	Nm	0.5			
Max. wire size		solid cable		stranded cable	
	mm <sup>2</sup>	1x6 / 2x2.5		1x4 / 2x2.5	
	AWG	1x10 / 2x14		1x12 / 2x14	

## Contact specification

**F 48 - Electrical life (AC) v contact current**  
Types 48.31/61

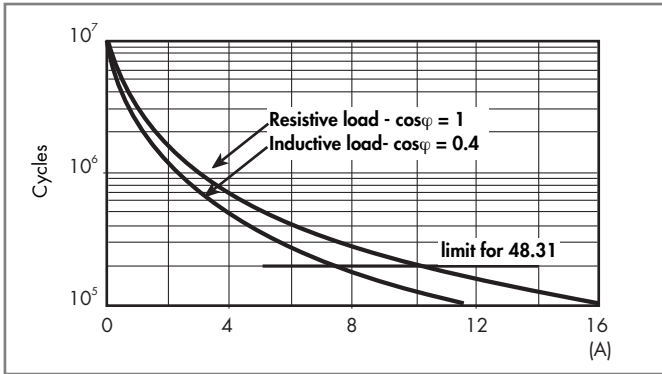

**F 48 - Electrical life (AC) v contact current**  
Type 48.62

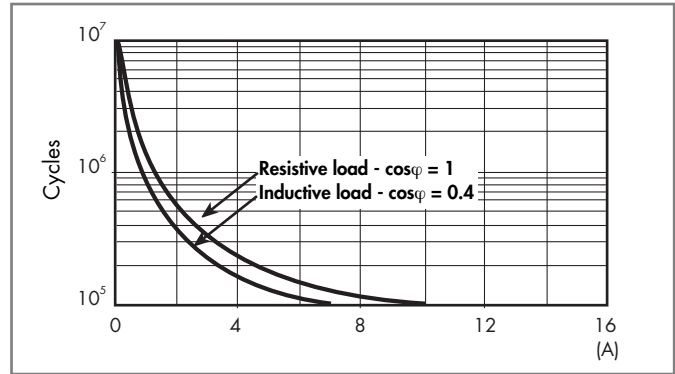

**F 48 - Electrical life (AC) v contact current**  
Types 48.52

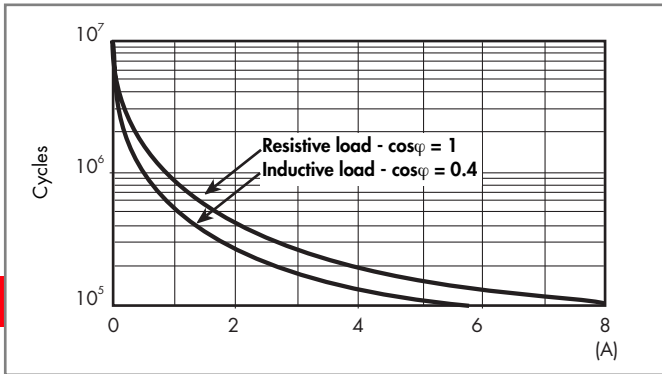

48

**H 48 - Maximum DC1 breaking capacity**  
Types 48.31/52/61

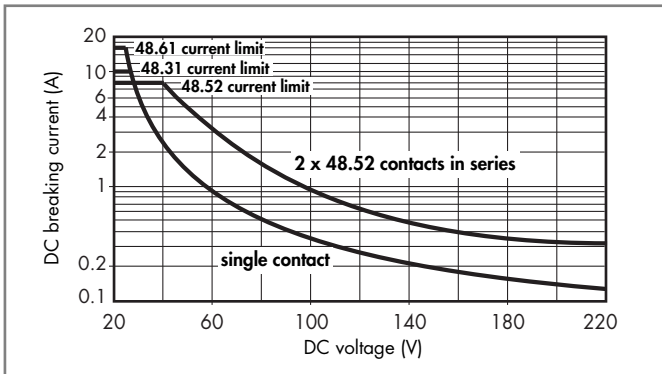

**H 48 - Maximum DC1 breaking capacity**  
Type 48.62

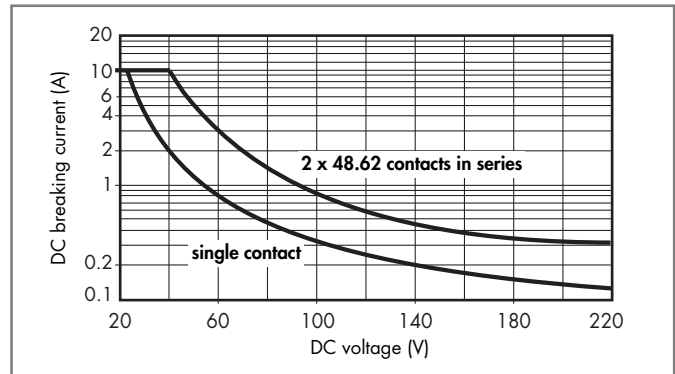

- When switching a resistive load (DC1) having voltage and current values under the curve, an electrical life of  $\geq 100 \cdot 10^3$  can be expected.
- In the case of DC13 loads, the connection of a diode in parallel with the load will permit a similar electrical life as for a DC1 load. Note: the release time for the load will be increased.

- When switching a resistive load (DC1) having voltage and current values under the curve, an electrical life of  $\geq 100 \cdot 10^3$  can be expected.
- In the case of DC13 loads, the connection of a diode in parallel with the load will permit a similar electrical life as for a DC1 load. Note: the release time for the load will be increased.

## Coil specifications

### DC coil data (0.5 W sensitive)

Nominal voltage $U_N$	Coil code	Operating range		Rated coil consumption I at $U_N$
		$U_{min}^*$	$U_{max}$	
V		V	V	mA
12	7.012	8.8	21	41
24	7.024	17.5	42	22.2
125	7.125	92	218	4

\* $U_{min} = 0.8 U_N$  for 48.61 and 48.62

### AC coil data

Nominal voltage $U_N$	Coil code	Operating range		Rated coil consumption I at $U_N$ (50Hz)
		$U_{min}$	$U_{max}$	
V		V	V	mA
12	8.012	9.6	13.2	90.5
24	8.024	19.2	26.4	46
110	8.110	88	121	10.1
120	8.120	96	132	11.8
230	8.230	184	253	7.0

### R 48 - DC coil operating range v ambient temperature

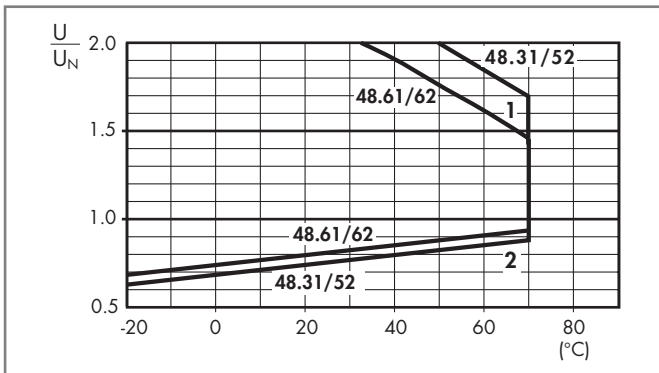

- 1 - Max. permitted coil voltage.
- 2 - Min. pick-up voltage with coil at ambient temperature.

### R 48 - AC coil operating range v ambient temperature

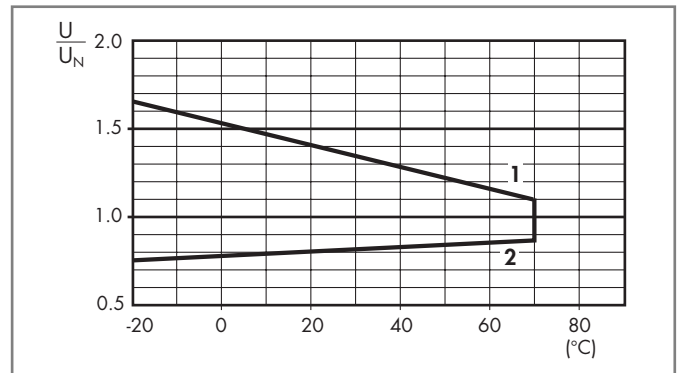

- 1 - Max. permitted coil voltage.
- 2 - Min. pick-up voltage with coil at ambient temperature.

## Combinations

Code	Type of socket	Type of relay	Module	Retaining clip
48.31	95.03	40.31	99.02	095.01
48.52	95.05	40.52	99.02	095.01
48.61	95.05	40.61	99.02	095.01
48.62	95.05	44.62	99.02	095.01

## Accessories



095.18

<b>8-way jumper link</b>	095.18
Rated values	10 A - 250 V

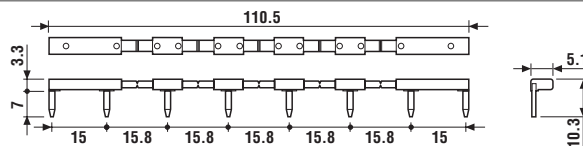

060.72

<b>Sheet of marker tags, plastic, 72 tags, 6x12 mm</b>	060.72
--	--------

## Packaging codes

How to code and identify retaining clip and packaging options for relay interface module.

Code options according to the last three letters:

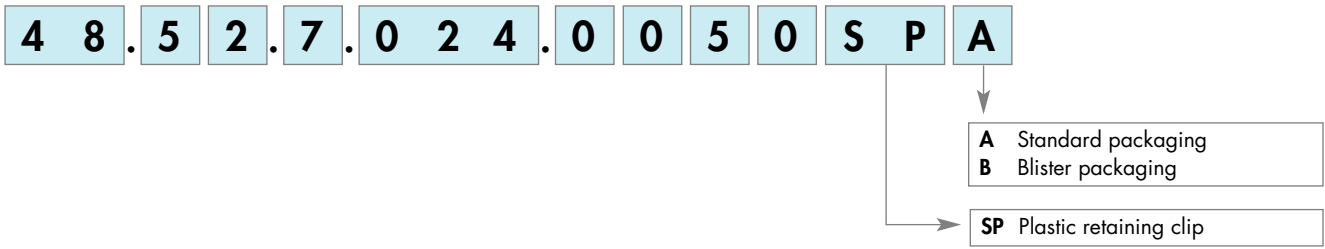

## X-ON Electronics

Largest Supplier of Electrical and Electronic Components

*Click to view similar products for [General Purpose Relays](#) category:*

*Click to view products by [Finder](#) manufacturer:*

Other Similar products are found below :

[APF30318](#) [JVN1AF-4.5V-F](#) [PCN-105D3MHZ](#) [5JO-10000S-SIL](#) [5JO-1000CD-SIL](#) [5JO-400CD-SIL](#) [LY2S-AC220/240](#) [LYQ20DC12](#)  
[6031007G](#) [6131406HQ](#) [6-1393099-3](#) [6-1393099-8](#) [6-1393122-4](#) [6-1393123-2](#) [6-1393767-1](#) [6-1393843-7](#) [6-1415012-1](#) [6-1419102-2](#) [6-](#)  
[1423698-4](#) [6-1608051-6](#) [6-1608067-0](#) [6-1616170-6](#) [6-1616248-2](#) [6-1616282-3](#) [6-1616348-2](#) [6-1616350-1](#) [6-1616350-8](#) [6-1616358-7](#) [6-](#)  
[1616359-9](#) [6-1616360-9](#) [6-1616931-6](#) [6-1617039-1](#) [6-1617052-1](#) [6-1617090-2](#) [6-1617090-5](#) [6-1617347-5](#) [6-1617353-3](#) [6-1617801-8](#) [6-](#)  
[1617802-2](#) [6-1618107-9](#) [6-1618248-4](#) [M83536/1-027M](#) [CX-4014](#) [MAHC-5494](#) [MAVCD-5419-6](#) [703XCX-120A](#) [7-1393100-5](#) [7-1393111-7](#)  
[7-1393144-5](#) [7-1393767-8](#)