



Standard And Fast Recovery Rectifiers

DESCRIPTION

This series of high-current single-phase bridge rectifiers are constructed with hermetically sealed rectifiers built with the same design and construction techniques used in military applications for the upmost in reliability. These include voidless glass encapsulation and internal "Category 1" metallurgical bonds. These 10A to 25A rectifier bridges are available in multiple working peak reverse voltage ratings per leg.

Important: For the latest information, visit our website <http://www.microsemi.com>.

FEATURES

- Current ratings to 25 amps
- V_{RWM} from 100 to 600 volts (see [part nomenclature](#) for all options)
- 150 °C junction temperature
- Surge ratings to 150 amps
- Recovery times to 500 ns
- MIL-PRF-19500 similarity
- RoHS compliant versions available

APPLICATIONS / BENEFITS

- Fuse-in-glass diodes design
- Electrically isolated aluminum case
- Controlled avalanche characteristics

MAXIMUM RATINGS

Parameters/Test Conditions	Symbol	Value	Unit
Junction and Storage Temperature	T_J and T_{STG}	-65 to +150	°C
Thermal Resistance Junction-to-Case	$R_{\theta JC}$	20	°C/W
Thermal Resistance Junction-to-Case per package	$R_{\theta JC}$	4.0	°C/W
Maximum Average DC Output Current: @ $T_C = 55\text{ °C}$	I_O	25 10 20 10	A
Maximum Average DC Output Current: @ $T_C = 100\text{ °C}$	I_O	18.5 6 14 6	A
Forward Surge Current (Peak): @ $T_C = 100\text{ °C}$	I_{FSM}	150 50 150 50	A
Solder Temperature @ 10 s		260	°C



(Actual appearance may vary)

**NA or NB
Package**

MSC – Lawrence

6 Lake Street,
Lawrence, MA 01841
Tel: 1-800-446-1158 or
(978) 620-2600
Fax: (978) 689-0803

MSC – Ireland

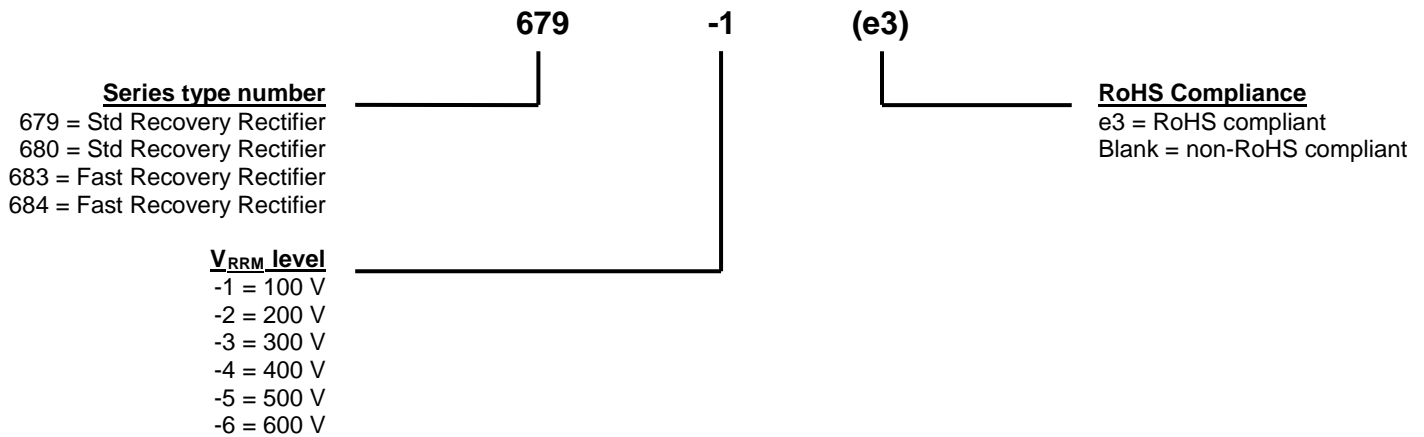
Gort Road Business Park,
Ennis, Co. Clare, Ireland
Tel: +353 (0) 65 6840044
Fax: +353 (0) 65 6822298

Website:

www.microsemi.com

MECHANICAL and PACKAGING

- CASE: Aluminum
- TERMINALS: Tin/lead or RoHS compliant matte tin
- MARKING: Alternating current input: AC
Cathode positive output: +
Anode negative: -
Part number is printed on the body
- WEIGHT: 679 series = 20 grams (typical), 680 series = 10 grams (typical)
- See [Package Dimensions](#) on last page.

PART NOMENCLATURE

SYMBOLS & DEFINITIONS

Symbol	Definition
I_{FSM}	Surge Peak Forward Current: The forward current including all nonrepetitive transient currents but excluding all repetitive transients (ref JESD282-B)
I_O	Average Rectified Output Current: The Output Current averaged over a full cycle with a 50 Hz or 60 Hz sine-wave input and a 180 degree conduction angle.
V_F	Forward Voltage: A positive dc anode-cathode voltage the device will exhibit at a specified forward current.
I_R	Reverse Current: The dc current flowing from the external circuit into the cathode terminal at the specified voltage V_R .
$V_{(BR)}$	Breakdown Voltage: A voltage in the breakdown region.
V_{RWM}	Working Peak Reverse Voltage: The peak voltage excluding all transient voltages (ref JESD282-B). Also sometimes known historically as PIV.
t_{rr}	Reverse Recovery Time: The time interval between the instant the current passes through zero when changing from the forward direction to the reverse direction and a specified decay point after a peak reverse current occurs.

ELECTRICAL CHARACTERISTICS

PART NUMBER	MAX FORWARD VOLTAGE PER LEG V_F (Note 2)	MAX REVERSE PEAK CURRENT $I_R @ V_{RWM}$ (Note 1)		MAX RECOVERY TIME t_{rr} ($I_F = 1.0 A$, $I_{RM} = 1.0 A$, $I_{R(REC)} = 0.5 A$)
	@ 25 °C	@ 25 °C	@ 100 °C	
	Volts	μA	μA	ns
679	1.2 @ 10 A	20	200	-
680	1.2 @ 2 A	2	50	-
683	1.2 @ 5 A	10	200	500
684	1.2 @ 2 A	5	100	500

NOTES: 1. MAX WORKING PEAK REVERSE VOLTAGE (V_{RWM}) numbering:

PART NUMBER				WORKING PEAK REVERSE VOLTAGE V_{RWM}	MINIMUM BREAKDOWN VOLTAGE $V_{(BR)}$
679-1	680-1	683-1	684-1	100	110
679-2	680-2	683-2	684-2	200	220
679-3	680-3	683-3	684-3	300	330
679-4	680-4	683-4	684-4	400	440
679-5	680-5	683-5	684-5	500	550
679-6	680-6	683-6	684-6	600	660

2. Pulse test: Pulse width 300 μ sec, duty cycle 2%.

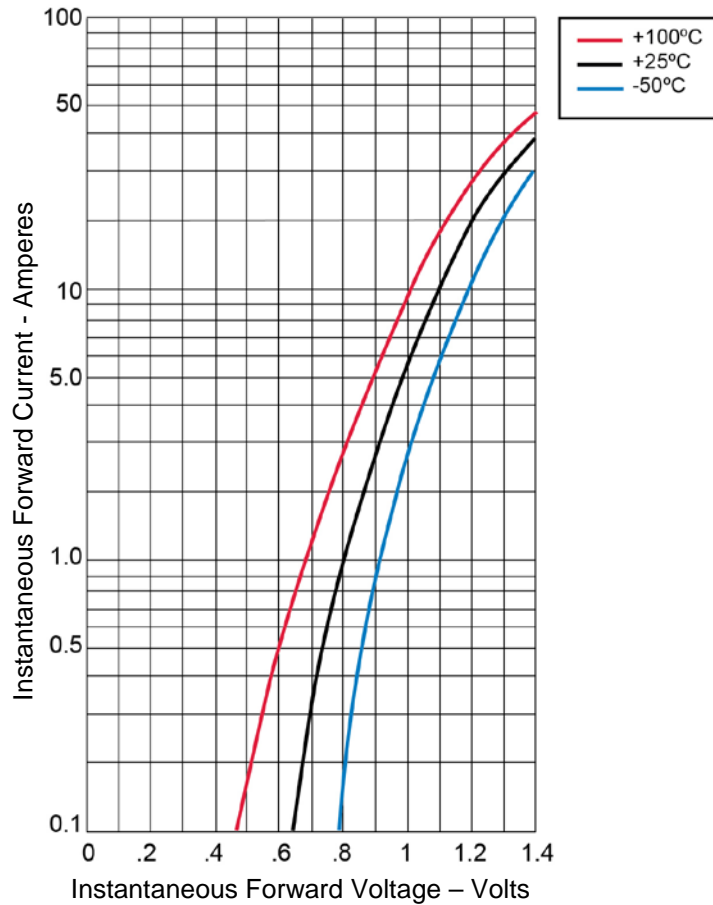
GRAPHS


FIGURE 1
Typical Forward Characteristics – Per Leg 679 Series

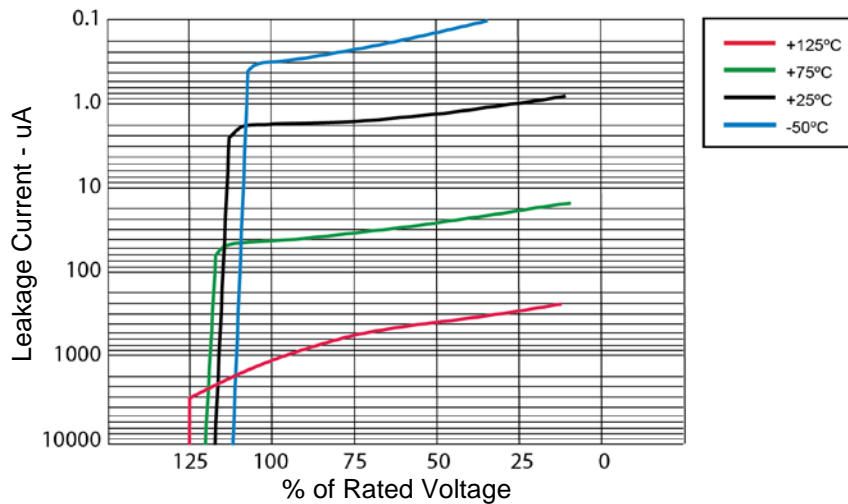


FIGURE 2
Typical Reverse Leakage Current – Per Leg 679 & 683 Series

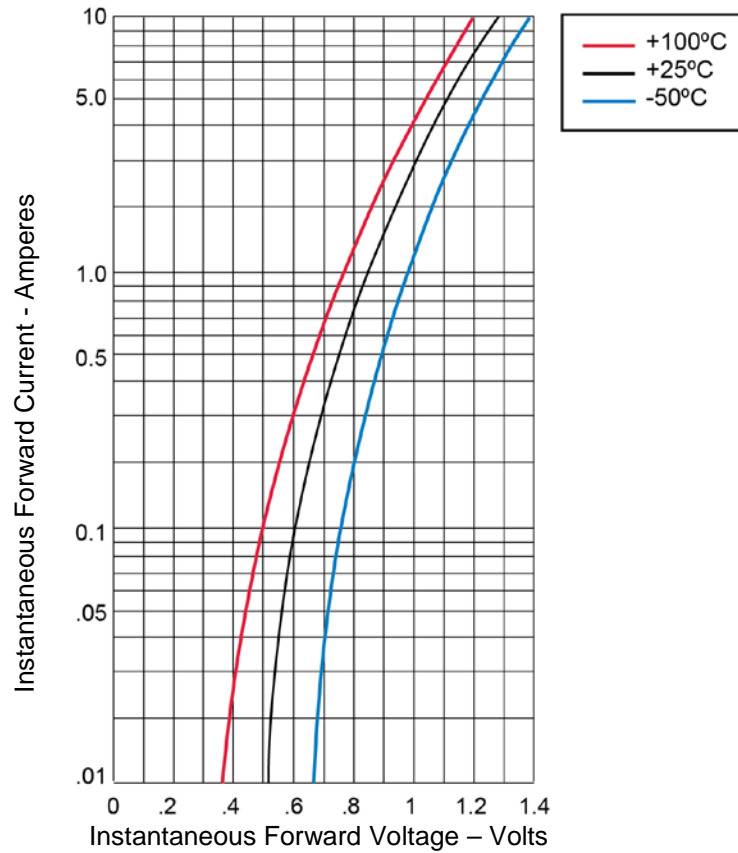
GRAPHS (continued)


FIGURE 3
Typical Forward Characteristics – Per Leg 683 Series

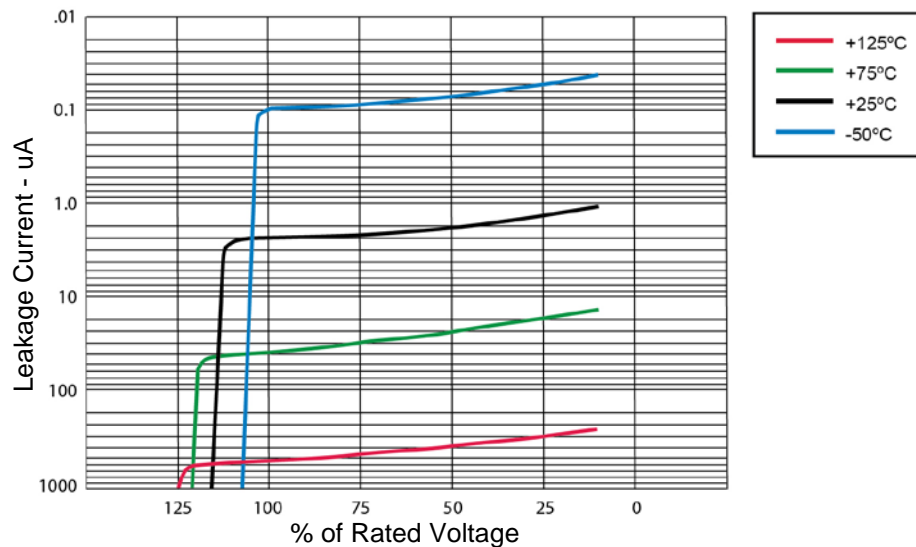


FIGURE 4
Typical Reverse Leakage Current – Per Leg 680 Series

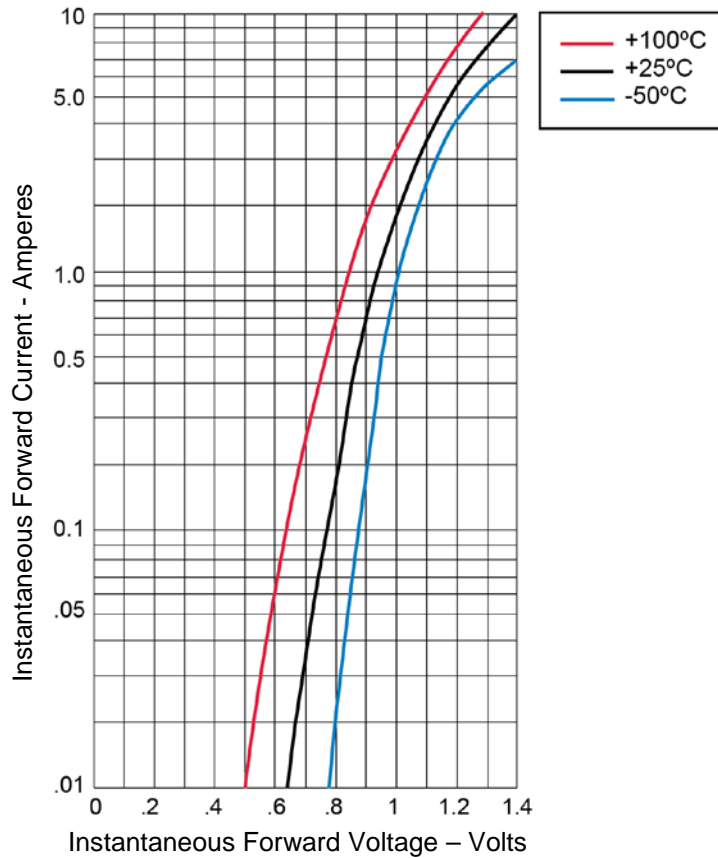
GRAPHS (continued)


FIGURE 5
Typical Forward Characteristics – Per Leg 680 & 684 Series

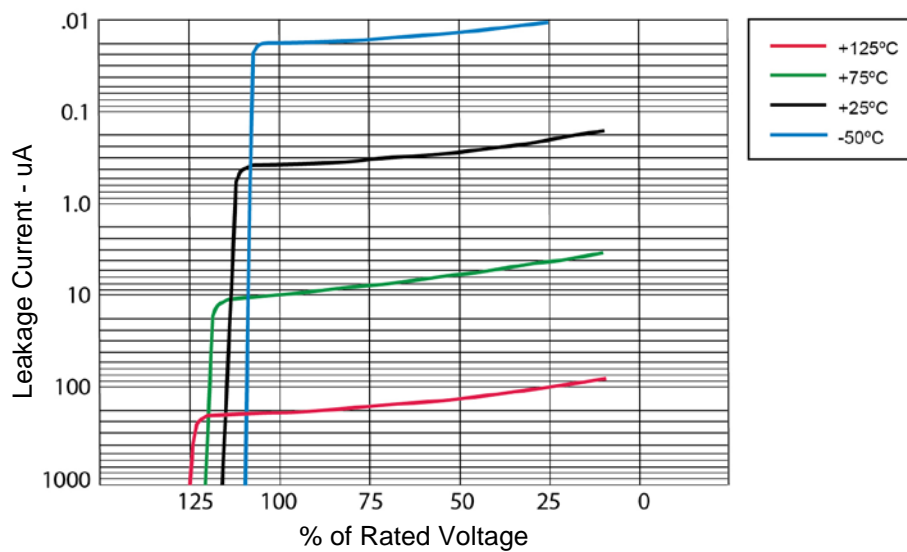
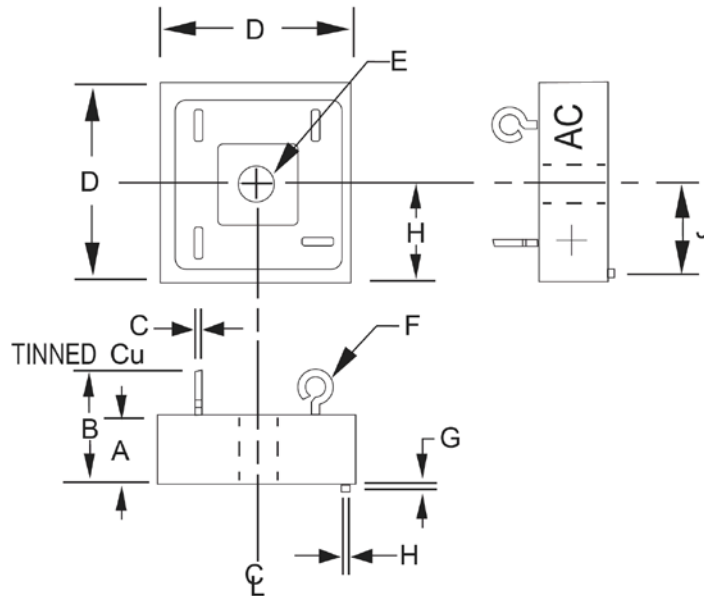
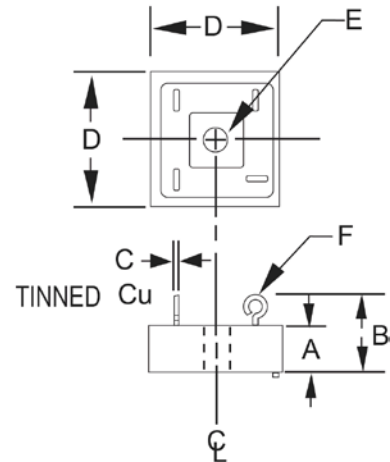


FIGURE 6
Typical Reverse Leakage Current – Per Leg 684 Series

PACKAGE DIMENSIONS
679 & 683


Ltr	Dimensions	
	Inch	Millimeters
A	0.328 MAX	8.33 MAX
B	0.750 MAX	19.05 MAX
C	0.04	1.02
D	1.125 MAX	25.58 MAX
E	0.193 DIA	4.90 DIA
F	0.09 DIA	2.29 DIA
G	0.062	1.57
H	0.062	1.57
J	0.50	12.7

680 & 684


Ltr	Dimensions	
	Inch	Millimeters
A	0.250 MAX	6.10 MAX
B	0.570 MAX	14.45 MAX
C	0.04	1.02
D	0.750 MAX	19.05 MAX
E	0.140 DIA	3.56 DIA
F	0.09 DIA	2.29 DIA

X-ON Electronics

Largest Supplier of Electrical and Electronic Components

Click to view similar products for [Bridge Rectifiers](#) category:

Click to view products by [Microsemi](#) manufacturer:

Other Similar products are found below :

[G3SBA60-E351](#) [GBJ1504-BP](#) [GBU10B-BP](#) [GBU15J-BP](#) [GBU15K-BP](#) [GBU4A-BP](#) [GBU4D-BP](#) [GBU6B-E3/45](#) [GSIB680-E3/45](#) [DB101-BP](#) [DF10SA-E345](#) [RMB2S](#) [RCG](#) [APT30DF100HJ](#) [APT60DF20HJ](#) [B2S-E3/80](#) [BU1506-E351](#) [BU15085S-E345](#) [BU1508-E3/45](#) [BU1510-E3/45](#) [RS404GL-BP](#) [RS405GL-BP](#) [G3SBA20-E3/51](#) [G5SBA20-E3/51](#) [G5SBA60-E3/51](#) [GBJ1502-BP](#) [GBL02-E351](#) [GBL10-E3/45](#) [GBU10J-BP](#) [GBU4J-BP](#) [GBU4K-BP](#) [GBU8B-E3/45](#) [GBU8D-BP](#) [GBU8J-BP](#) [GSIB1520-E3/45](#) [MB1510](#) [MB352W](#) [MB6M-G](#) [B2M-E345](#) [B40C7000A](#) [B500C7000A](#) [MP5010W-BP](#) [MP501W-BP](#) [MP502-BP](#) [BR1005-BP](#) [BR101-BP](#) [BU1006-E345](#) [BU12065S-E3/45](#) [BU1508-E3/51](#) [BU2006-E3/45](#) [BU2008-E345](#)